









CR-V  PHEV

As you read this manual, you will find Information that is preceded by a symbol **NOTICE**. This information is intended to help you avoid damage to your vehicle, other property, or the environment.

Symbols   or    on labels attached to your vehicle are to remind you to read this owner's manual for proper and safe operation of your vehicle.

 or  is colour-coded to indicate "danger" (red), "warning" (orange), or "caution" (amber).

➤ **Safety Labels** P. 114

## A Few Words About Safety

---

Your safety, and the safety of others, is very important. And operating this vehicle safely is an important responsibility.

To help you make informed decisions about safety, we have provided operating procedures and other information on labels and in this manual. This information alerts you to potential hazards that could hurt you or others.

Of course, it is not practical or possible to warn you about all the hazards associated with operating or maintaining your vehicle. You must use your own good judgement.

You will find this important safety information in a variety of forms, including:

- **Safety Labels** - on the vehicle.
- **Safety Messages** - preceded by a safety alert symbol  and one of three signal words: **DANGER**, **WARNING**, or **CAUTION**. These signal words mean:

 **DANGER**

You WILL be KILLED or SERIOUSLY HURT if you don't follow instructions.

 **WARNING**

You CAN be KILLED or SERIOUSLY HURT if you don't follow instructions.

 **WARNING**

You CAN be KILLED or SERIOUSLY HURT if you don't follow instructions.

 **CAUTION**

You CAN be HURT if you don't follow instructions.

- **Safety Headings** - such as Important Safety Precautions.
- **Safety Section** - such as Safe Driving.
- **Instructions** - how to use this vehicle correctly and safely.

This entire book is filled with important safety information - please read it carefully.

## Event Data Recorders

Your vehicle is equipped with several devices commonly referred to as Event Data Recorders. They record various types of real time vehicle data such as SRS airbag deployment and SRS system components failure.

This data belongs to the vehicle owner and may not be accessed by anyone else except as legally required or with the permission of the vehicle owner.

However this data may be accessed by Honda, its authorised dealers and authorised repairers, employees, representatives and contractors only for the purpose of the technical diagnosis, research and development of the vehicle.

## Service Diagnostic Recorders

Your vehicle is equipped with service-related devices that record information about powertrain performance and driving conditions. The data can be used to help technicians diagnose, repair and maintain the vehicle. This data may not be accessed by anyone else except as legally required or with the permission of the vehicle owner.

However this data may be accessed by Honda, its authorised dealers and authorised repairers, employees, representatives and contractors only for the purpose of the technical diagnosis, research and development of the vehicle.

## Digital Key

For more information on Digital Key, please visit the URL below.  
<https://hondanews.eu/eu/en/corporate/media/photos/69919/honda-motor-europe-bracknell-headquarters>

### EU Countries

## Battery Information

The importer information for the battery installed in the vehicle is as follows.

Importer Name:

Honda Motor Europe Ltd - Aalst Office

Postal address:

Wijngaardveld 1 (Noord V) 9300 Aalst - Belgium

## Owner's Manual Application Terms and Conditions

### General

This application allows your Display Audio to automatically search for owner's manual updates that are specific to your vehicle and Display Audio every time the power mode of the vehicle is set to ON. This application periodically transmits a limited amount of vehicle and device information to our servers: Vehicle Identification Number (VIN), Display Audio hardware serial number, preferred language, Internet Protocol (IP) address, transaction log (alerts for or views of updates, update downloads and installation, usage of the owner's manual application), etc. When the application finds an update from the server, it prompts you to download and install.

When your Display Audio searches our servers for updates, we will automatically provide you with the opportunity to update the owner's manual. We will also maintain a log of the updates that are installed on our servers.

### Your Personal Data

Should the aforementioned information transmitted to Honda constitute personal information in your region, please note that this information will be treated in strict accordance with the rules and regulations outlined in this notice as well as applicable data protection law.

The terms of our privacy policy are incorporated into these terms by reference and your use of system updates will be subject to the privacy policy. Our privacy policy sets out information about how we and any named third parties will process any personal data we collect from you or that you provide to us, via the utility. (See the Honda website (<https://www.privacynotice.honda.eu>) for further details.)

Honda collects, uses, and stores your personal data for the reasons set out below:

Where necessary for Honda's legitimate interests, as listed below, and where our interests are not overridden by your data protection rights.

- to deliver owner's manual updates to you;
- to allow us to improve and optimize the owner's manual application and services;
- to respond to user questions and complaints; and for internal record keeping.

Protecting our legitimate business interests and legal rights. This includes, but is not limited to, use in connection with compliance, regulatory, auditing, legal claims (including disclosure of such information in connection with legal process or litigation) and other ethics and compliance reporting requirements

Honda will also convert personal data into anonymous data and use it (normally on an aggregated statistical basis) for uses such as market research and analysis, to improve the owner's manual, to analyze trends, and to assess the success of software update releases. Aggregated personal information does not personally identify you or any other use of the owner's manual.

Honda may share this data with Honda's world wide support organization or affiliated Honda companies or other third parties engaged by Honda for the purposes of rendering support services in connection with system support.

The on-board owner's manual may be terminated without warning. If service is terminated, please continue to use the owner's manual via Honda's homepage. For vehicles with the manual already installed, it can continue to be used as long as you do not perform a factory reset.

## System Updates Terms & Conditions

### General

Your vehicle has an application that allows your Display Audio to automatically search for Honda software updates that are specific to your Display Audio and its connected devices (initially every week via Wi-Fi or every four (4) weeks via Telematics Control Unit (TCU)\*, queries may occur more or less frequently due to internet outages, retries, direct user action, WAP push from the server, or a change in query policy on the Honda servers). This application periodically transmits to our servers a limited amount of vehicle and device information (Vehicle Identification Number (VIN), the Model Type (MT) Identification Number, Hardware and Software Part Number, Serial Number, Software Version, preferred language, Internet Protocol (IP) address, Transaction Log (alert or update viewing, update download and installation, software status), etc.). When the application finds an update from the server, the application initially asks permission to download and install the update. Where available, in your settings menu you may elect to automatically download and install these updates or you may elect to manually update the system.

When your Display Audio searches our servers for updates or alerts, we will automatically provide you with the opportunity to update your devices or transmit the update or alert directly to your Display Audio. We will also maintain on our servers a log of the updates or alerts that are installed.

### Your Personal Data

Should the aforementioned information transmitted to Honda constitute personal information in your region, please note that this information will be treated in strict accordance with the rules and regulations outlined in this notice as well as applicable data protection law.

\* Not available on all models

The terms of our privacy policy are incorporated into these terms by reference and your use of system updates will be subject to the privacy policy. Our privacy policy sets out information about how we and any named third-parties will process any personal data we collect from you or that you provide to us via the application. See the Honda website for further details.

Honda collects, users, and stores your personal data for the reasons set out below:

- to deliver system updates and related services
- to allow us to improve and optimize the system updates products and services
- to respond to user questions and complaints
- for internal record keeping
- where necessary for Honda's legitimate interests, as listed below, and where our interests are not overridden by your data protection rights
- as otherwise described in Honda's Privacy Notice and Vehicle Data Privacy Notice

Protecting our legitimate business interests and legal rights includes, but is not limited to, use in connection with compliance, regulatory, auditing, legal claims (including disclosure of such information in connection with legal process or litigation), and other ethics and compliance reporting requirements.

Honda will also convert personal data into anonymous data and use it (normally on an aggregated statistical basis) for uses such as market research and analysis, to improve the system updates, to analyze trends, and to assess the success of software update releases. Aggregated personal information does not personally identify you or any other use of system updates.

Honda may share this data with Honda's worldwide support organization or affiliated Honda companies or other third-parties engaged by Honda for the purposes of rendering support services in connection with system support.

This owner's manual should be considered a permanent part of the vehicle and should remain with the vehicle when it is sold.

This owner's manual covers all models of your vehicle. You may find descriptions of equipment and features that are not on your particular model.

The images throughout this owner's manual (including the front cover) that depict features, equipment, Audio/Information screen details, and Meter screens are only examples and may not be representative of your particular model.

The information and specifications included in this publication were in effect at the time of approval for printing. Honda Motor Co., Ltd. reserves the right, however, to discontinue or change specifications or design at any time without notice and without incurring any obligation.

Although this manual is applicable to both right-hand and left-hand drive models, the illustrations contained in this manual mainly refer to the left-hand drive models.

#### ➤ **Safe Driving P. 43**

For Safe Driving P. 44      Seat Belts P. 49      Airbags P. 62  
Safety Labels P. 114

#### ➤ **Instrument Panel P. 115**

Indicators P. 116      Gauges and Displays P. 157

#### ➤ **Controls P. 187**

Clock P. 188      Locking and Unlocking the Doors P. 189  
Operating the Switches Around the Steering Wheel P. 227  
Interior Convenience Items P. 263

#### ➤ **Features P. 289**

Audio System P. 290      Display Audio P. 292  
Emergency Call (eCall) P. 408      Refuel Recommend P. 413

#### ➤ **Driving P. 415**

Before Driving P. 416      Towing a Trailer P. 420  
Braking P. 590      Parking Your Vehicle P. 600  
Charging P. 654

#### ➤ **Maintenance P. 671**

Before Performing Maintenance P. 672      Service Reminder System\* P. 676  
Checking and Maintaining Wiper Blades P. 706  
Climate Control System Maintenance P. 723      Cleaning P. 726

#### ➤ **Handling the Unexpected P. 735**

If a Tyre Goes Flat P. 736      Handling of the Jack P. 748  
Indicator Coming On/Blinking P. 757      Fuses P. 764  
If You Cannot Open the Charge Lid P. 773  
Evacuating the Vehicle in an Emergency P. 776

#### ➤ **Information P. 779**

Specifications P. 780      Identification Numbers P. 783  
Open Source Licence P. 830

# Contents

Post-Collision Braking System P. 84      Child Safety P. 85      Exhaust Gas Hazard P. 114

Tailgate P. 202      Security System P. 213      Windows P. 220      Panoramic Roof P. 223  
Mirrors P. 248      Seats P. 251  
Climate Control System P. 283

Audio Error Messages P. 397      General Information on the Audio System P. 398

Off-road Guidelines P. 426      When Driving P. 428      Honda SENSING 360 P. 479  
Multi-View Camera P. 612      Honda Parking Pilot P. 626      Refueling P. 651  
Fuel Economy and CO<sub>2</sub> Emissions P. 669

Maintenance Schedule\* P. 681      Maintenance Under the Bonnet P. 689      Replacing Light Bulbs P. 703  
Checking and Maintaining Tyres P. 710      12-Volt Battery P. 715      Remote Transmitter Care P. 721  
Accessories and Modifications P. 733

Power System Won't Start P. 749      If the 12-Volt Battery Is Dead P. 753      Overheating P. 755  
Emergency Towing P. 771      If You Cannot Open the Fuel Fill Door P. 772  
If You Cannot Disengage the Charging Connector P. 774      If You Cannot Open the Tailgate P. 775

Devices that Emit Radio Waves\* P. 784      Declaration of conformity Content Outline\* P. 827

Quick Reference Guide P. 6

Safe Driving P. 43

Instrument Panel P. 115

Controls P. 187

Features P. 289

Driving P. 415

Maintenance P. 671

Handling the Unexpected P. 735

Information P. 779

Index P. 831

# Visual Index

Left-hand Drive Type

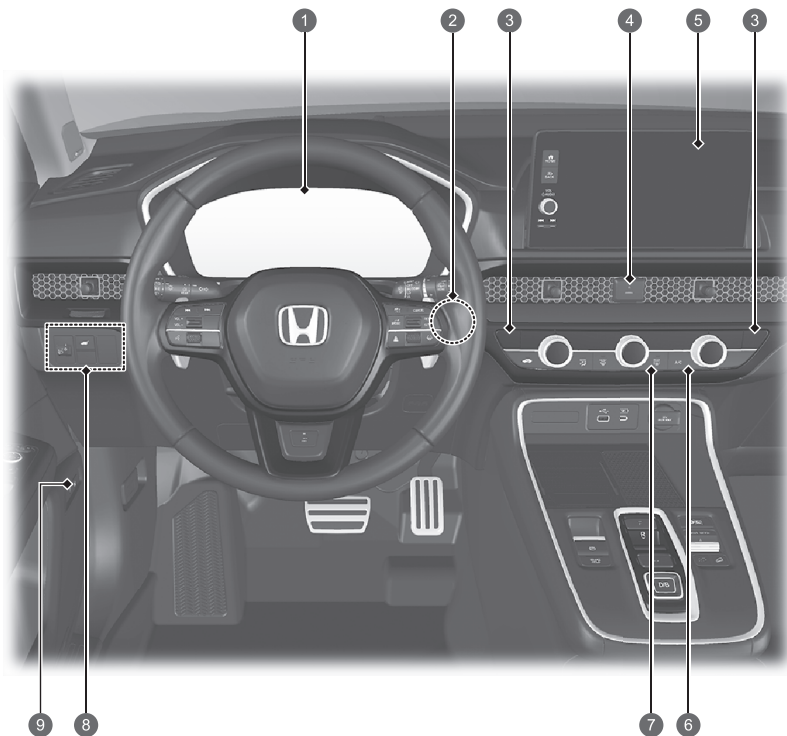

- 1 System Indicators ➔ P.116  
Gauges ➔ P.157  
Driver Information Interface ➔ P.138
- 2 POWER Button ➔ P.227
- 3  Front Seat Heater Buttons ➔ P.281  
 Front Seat Ventilation Buttons\* ➔ P.281
- 4 Hazard Warning Button 
- 5 Audio System ➔ P.290  
Navigation System  
 See the Navigation System Manual
- 6 Climate Control System ➔ P.283
- 7  Rear Demister/Heated Door Mirror Button ➔ P.244
- 8  Power Tailgate Button ➔ P.208  
 Headlight Adjuster\* ➔ P.237
- 9  Fuel Fill Door Release Button ➔ P.652

## Right-hand Drive Type

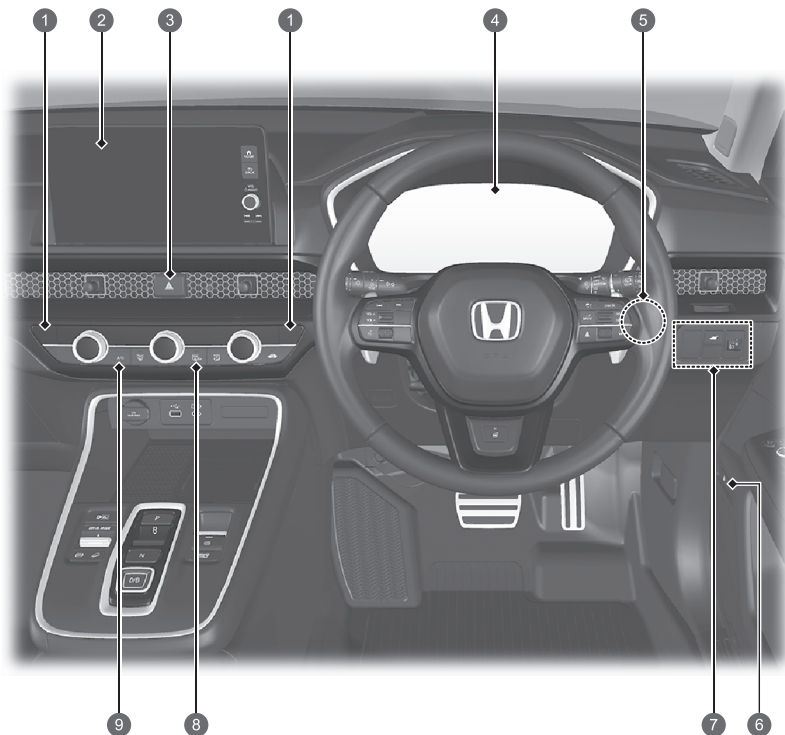

- 1 Front Seat Heater Buttons ➔ P.281  
 Front Seat Ventilation Buttons\* ➔ P.281
- 2 Audio System ➔ P.290  
 Navigation System ➔ See the Navigation System Manual
- 3 Hazard Warning Button
- 4 System Indicators ➔ P.116  
Gauges ➔ P.157  
Driver Information Interface ➔ P.138
- 5 POWER Button ➔ P.227
- 6 Fuel Fill Door Release Button ➔ P.652
- 7 Power Tailgate Button ➔ P.208  
 Headlight Adjuster\* ➔ P.237
- 8 Rear Demister/Heated Door Mirror Button ➔ P.244
- 9 Climate Control System ➔ P.283



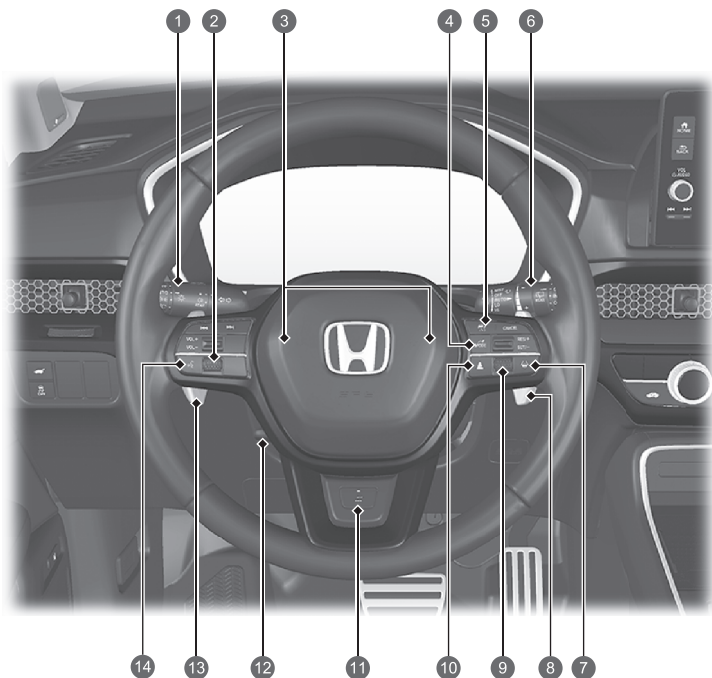

# Visual Index

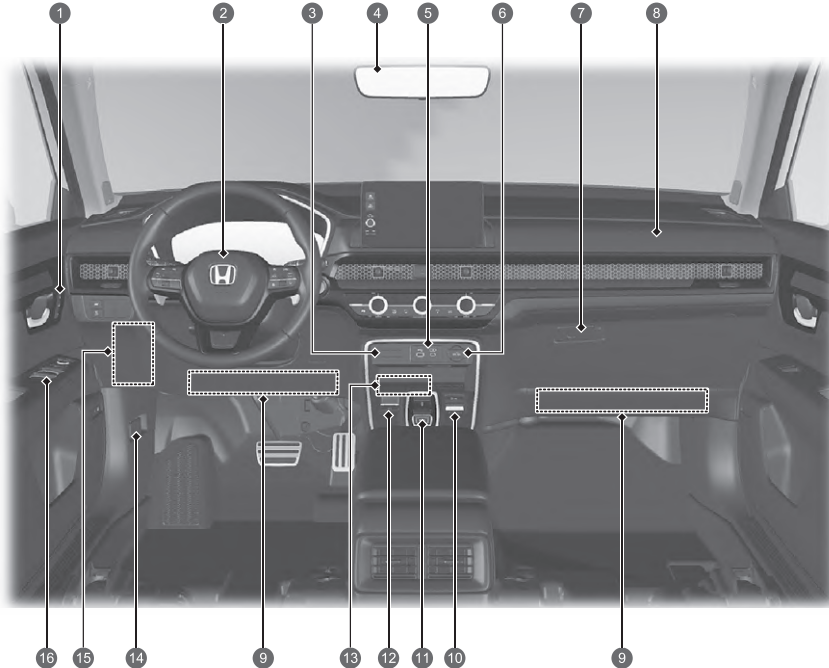

- ①  **Headlights** /  **Turn Signals**  
↔ P. 229, 231  
↔ P. 475
- ② **Left Selector Wheel** ↔ P. 296
- ③ **Horn** (Press the area around )
- ④  **Button** ↔ P. 454
- ⑤  **Adaptive Cruise Control (ACC) with Low Speed Follow Buttons** ↔ P. 527
- ⑥  **Wipers/Washers** ↔ P. 241
- ⑦  **CAMERA Button** ↔ P. 613
- ⑧  **Lane Keeping Assist System (LKAS) Button** ↔ P. 553
- ⑨ **Deceleration Paddle Selector**  ↔ P. 441
- ⑩ **Right Selector Wheel** ↔ P. 164
- ⑪  **Interval Button** ↔ P. 543
- ⑫  **Heated Steering Wheel Button**  
↔ P. 280
- ⑬ **Steering Wheel Adjustments** ↔ P. 247
- ⑭ **Deceleration Paddle Selector**  ↔ P. 441
- ⑮ **Hands-Free Telephone System Buttons**  
↔ P. 379
- ⑯ **Audio Remote Controls** ↔ P. 296

## Left-hand Drive Type





- 1 Memory Buttons\* ➔ P. 246  
SET Button\* ➔ P. 246
- 2 Driver's Front Airbag ➔ P. 64
- 3 Passenger's Front Airbag OFF Indicator ➔ P. 82
- 4 Rearview Mirror ➔ P. 248
- 5 USB Ports ➔ P. 295
- 6 Accessory Power Socket ➔ P. 276
- 7 Glove Box ➔ P. 266
- 8 Passenger's Front Airbag ➔ P. 64
- 9 Knee Airbags ➔ P. 70
- 10  Honda Parking Pilot Switch ➔ P. 626  
 Drive Mode Switch ➔ P. 445  
 e Button ➔ P. 19  
 Hill Descent Control Button ➔ P. 452
- 11 Shift Button ➔ P. 434
- 12 Electric Parking Brake Switch ➔ P. 590  
Automatic Brake Hold Button ➔ P. 594
- 13 Wireless Charger ➔ P. 277
- 14 Bonnet Release Handle ➔ P. 690
- 15 Interior Fuse Box ➔ P. 766
- 16 Door Mirror Controls ➔ P. 249  
Master Door Lock Switch ➔ P. 200  
Power Window Switches ➔ P. 221

# Visual Index

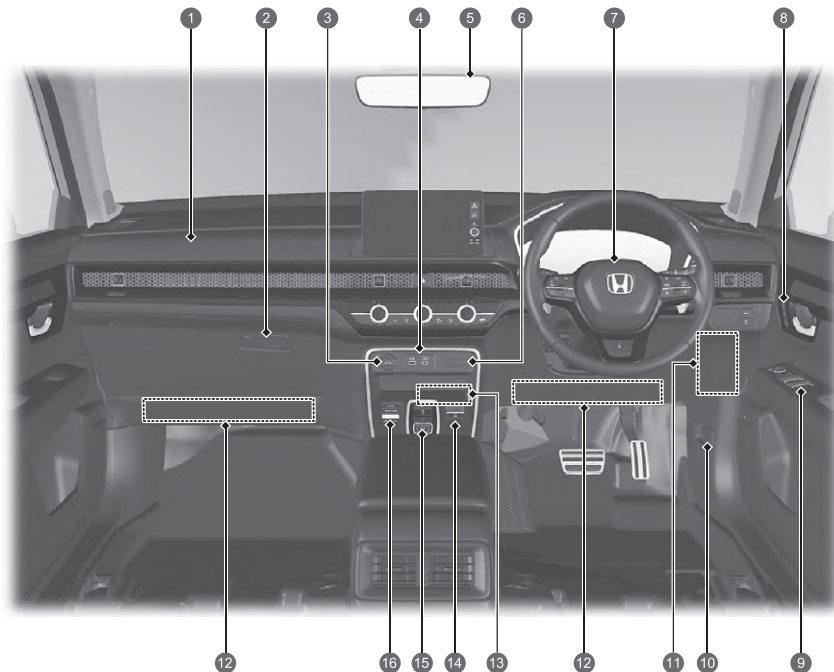
Right-hand Drive Type



- 1 Passenger's Front Airbag ➡ P. 64
- 2 Glove Box ➡ P. 266
- 3 Accessory Power Socket ➡ P. 276
- 4 USB Ports ➡ P. 295
- 5 Rearview Mirror ➡ P. 248
- 6 Passenger's Front Airbag OFF Indicator ➡ P. 82
- 7 Driver's Front Airbag ➡ P. 64
- 8 Memory Buttons\* ➡ P. 246  
SET Button\* ➡ P. 246
- 9 Door Mirror Controls ➡ P. 249  
Master Door Lock Switch ➡ P. 200  
Power Window Switches ➡ P. 221
- 10 Bonnet Release Handle ➡ P. 690
- 11 Interior Fuse Box ➡ P. 766
- 12 Knee Airbags ➡ P. 70
- 13 Wireless Charger ➡ P. 277
- 14 Electric Parking Brake Switch ➡ P. 590  
Automatic Brake Hold Button ➡ P. 594
- 15 Shift Button ➡ P. 434
- 16  Honda Parking Pilot Switch ➡ P. 626  
Drive Mode Switch ➡ P. 445  
 e Button ➡ P. 19  
 Hill Descent Control Button ➡ P. 452

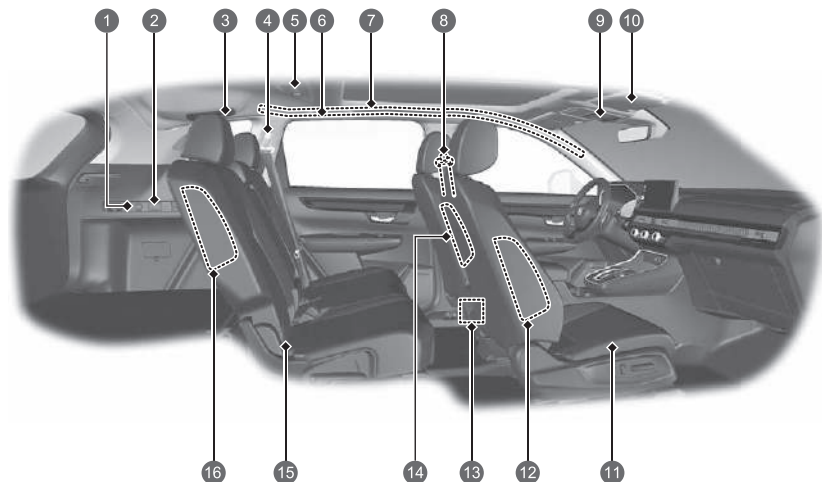

- 1 Accessory Power Socket ➔ P.276
- 2 Luggage Area Lights ➔ P.265
- 3 Seat Belt with Detachable Anchorage ➔ P.57
- 4 Seat Belt (Installing a Child Restraint System) ➔ P.106  
Seat Belt to Secure a Child Restraint System ➔ P.108
- 5 Rear Map Lights ➔ P.264
- 6 Grab Handle  
Coat Hooks ➔ P.269
- 7 Side Curtain Airbags ➔ P.79
- 8 Seat Belts ➔ P.49
- 9 Panoramic Roof Switch ➔ P.225  
Sunshade Switch ➔ P.226  
Front Map Lights ➔ P.264  
Sunglasses Holder ➔ P.271  
SOS Button ➔ P.410  
Ultrasonic/Tilt Sensor OFF Button\* ➔ P.216
- 10 Sun Visors  
Vanity Mirrors
- 11 Front Seat ➔ P.251
- 12 Front Side Airbags ➔ P.76
- 13 USB Ports ➔ P.295
- 14 Centre Airbag ➔ P.74
- 15 Rear Seat ➔ P.255  
Lower Anchorage Points to Secure a Child Restraint Systems ➔ P.101
- 16 Rear Side Airbags ➔ P.76

# Visual Index

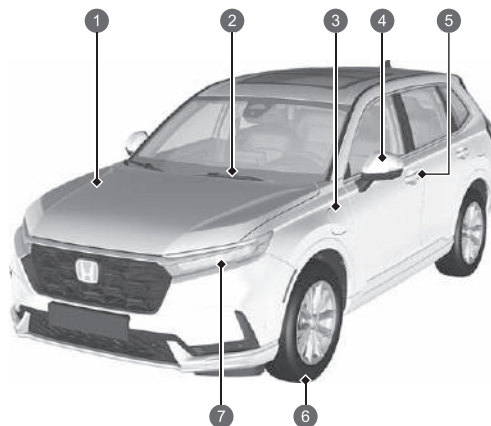

- 1 Maintenance Under the Bonnet ➔ P. 689
- 2 Windscreen Wipers ➔ P. 241, 706
- 3 How to Charge ➔ P. 658
- 4 Power Door Mirrors ➔ P. 249
- Side Turn Signal Lights ➔ P. 231, 703
- 5 Door Lock/Unlock Control ➔ P. 192
- 6 Tyres ➔ P. 710, 736
- 7 Headlights ➔ P. 229, 703
- Front Turn Signal Lights, Position/Daytime Running Lights ➔ P. 231, 703
- Active Cornering Lights\* ➔ P. 235, 703

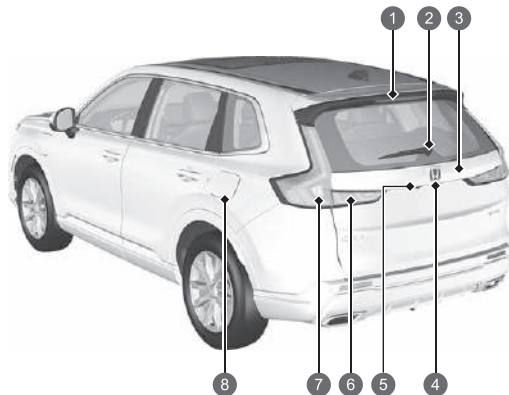

- 1 High-Mount Brake Light ➔ P. 704
- 2 Rear Wiper ➔ P. 243, 708
- 3 Opening/Closing the Tailgate ➔ P. 202
- 4 Tailgate Outer Handle ➔ P. 203
- Rear Licence Plate Light ➔ P. 229, 704
- 5 Multi-View Camera ➔ P. 612
- 6 Taillights ➔ P. 229, 704
- Back-Up Lights ➔ P. 704
- Rear Fog Light ➔ P. 233, 704
- 7 Brake/Taillights ➔ P. 229, 703
- Rear Turn Signal Lights ➔ P. 231, 703
- Rear Side Marker Lights ➔ P. 703
- 8 How to Refuel ➔ P. 652

# e:PHEV

Your e:PHEV vehicle uses both an electric motor and/or a petrol engine as propulsion sources, with the electric motor receiving electricity from an internal High Voltage battery and/or internal generator.

When the High Voltage battery has sufficient charge levels, the vehicle is propelled solely by the power supplied by the High Voltage battery (Electric) or by a combination of power supplied by both the High Voltage battery and the generator which is driven by the engine.

When the High Voltage battery charge drops to low levels, the vehicle is propelled by power supplied by the engine-driven generator.

The system offers three different propulsion sources: You can drive with the electric motor, the petrol engine, or both the electric motor and the petrol engine (hybrid). Under most driving conditions, the system automatically selects an appropriate propulsion source based on the current driving needs.

The High Voltage battery can be charged while the vehicle is running or while it is plugged in.

 **Power Source and Charging**  **P.17**

There are three drive modes: ECON, NORMAL, and SPORT

Regardless of the drive mode that is activated, when the accelerator pedal is depressed past a certain point, the engine starts. When this occurs, electrical power generated by the engine combines with electrical power from the battery to provide greater driving force. If you select ECON mode, the threshold for the engine to provide additional power is higher than it is when the vehicle operates under either of the two sources.

To maintain fuel efficiency, keep steady pressure on the accelerator pedal and avoid aggressive acceleration and deceleration.

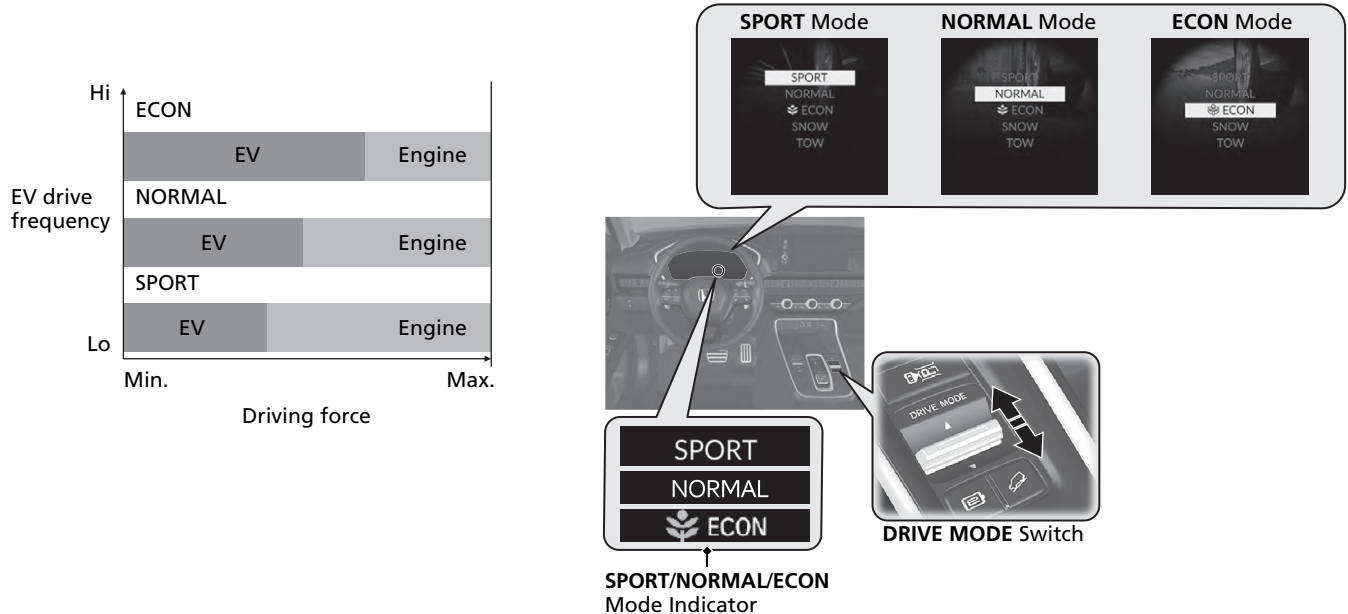

The indicator for the mode that you have selected comes on.

## Auto Engine Stop/Start

The car will select the appropriate source of power depending on the drive mode you select.

As a result, the engine will automatically start or stop as needed to either charge the battery or provide supplemental power.

Under certain circumstances, the engine may turn on or, if it is already on, it may not turn off.

- You are going uphill or accelerating aggressively.
- The climate control system is in heavy use.
- The ambient temperature is too hot or too cold.
- The High Voltage Battery state of charge is very low.
- The engine has not been sufficiently warmed up.

## Predictive Eco Assist







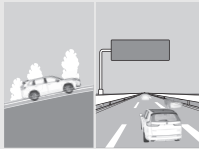

By predicting road information during navigation route guidance, Predictive Eco Assist automatically switches between **EV** mode and **SAVE** mode, helping you to drive more economically to your destination.

If there are any stops on the way to the destination, it works more effectively if they are set as waypoints.

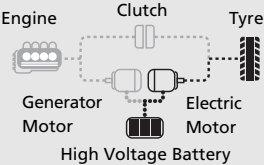
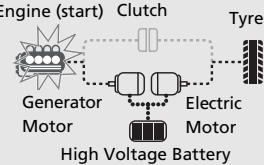
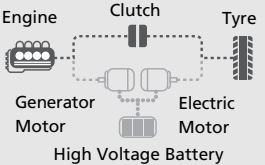
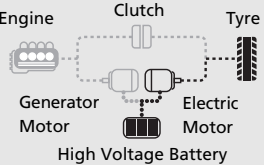
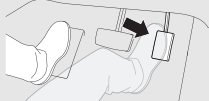
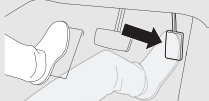
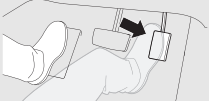
If you leave the suggested navigation route, Predictive Eco Assist may not function in a way that is suitable for your route.

You can turn Predictive Eco Assist on and off in Vehicle Settings using the audio/information screen.

➤ Customized Features ➡ P. 360

<p>Driving image</p>				
<p>Driving mode</p>	<p>Electric Vehicle (EV)</p>	<p>Hybrid (HV)</p>	<p>Engine (direct drive)</p>	<p>Regeneration</p>
<p>Driving state</p>	<p>Engine stops when accelerating slowly and traveling at low to medium speeds. (Engine may start under certain conditions.)</p> 	<p>Engine starts and power is generated when needed, such as when quickly accelerating, going at high speeds, or going up hills.</p> 	<p>Power is supplied by the engine only when driving at high speeds and the accelerator pedal is pressed lightly.</p> 	<p>The High Voltage battery is charged when the vehicle is moving but the accelerator pedal is released and the vehicle is decelerating.</p> 
<p>Accelerator pedal status</p>	<p>Pressed lightly</p> 	<p>Pressed firmly</p> 	<p>Pressed lightly</p> 	<p>Released</p> 
<p>Power flow monitor</p> <p><b>Power Flow Monitor</b></p> <p> P.166</p>				

## Power Source and Charging

### Electric Source

When the High Voltage battery is sufficiently charged, the vehicle is propelled solely by the electric motor. When the remaining power of the High Voltage battery drops to a certain level, the vehicle switches to hybrid.

### Hybrid Source

In hybrid, the electric motor receives power either from the High Voltage battery or from the generator which is driven by the engine, or from both the High Voltage battery and generator.

### Engine Source

When the vehicle is driving under light load within a certain speed range, the engine provides direct power to the wheels.

### Charging the High Voltage Battery P. 656

There are a number of ways to charge the High Voltage battery. You can:

- Use a standard household outlet.
- Use a public charging station.
- Enable hybrid charge and let the battery charge while the vehicle is being driven.
  - ▶ **CHARGE** mode will not completely charge the High Voltage battery to 100%.

When charging from an external source, you can schedule the start and end time for charging.

 P. 662



### Regenerative Energy and Regenerative Braking

When the vehicle is decelerating or descending a hill, the electric motor acts as a generator that recovers a portion of the energy that was used to accelerate the vehicle.

The regenerative force that the electric motor applies to the wheels when it is in regenerative mode helps to slow the vehicle down in a manner similar to engine braking which is used on conventional vehicles. If you want to slow the vehicle down at a faster rate without using the brakes, you can use the deceleration paddle selector to increase the resistive force.

## Energy Efficiency

As with a petrol powered vehicle, the fuel efficiency and the range of this vehicle is most impacted by the driver's driving style. Aggressive acceleration and high-speed driving can easily trigger the system to switch the propulsion source to the petrol-powered engine. Climate control system usage also has a strong impact with heavy usage negatively affecting the vehicle's range. In particular, when it is cold outside, climate control system consumes a lot of power, so the vehicle's driving range on electric power can be reduced. The capacity of the High Voltage battery will be less when the temperature is low.

## Battery Type

There are two types of batteries used in this vehicle, a standard 12-volt battery that powers the airbags, the interior and exterior lights, and other standard 12-volt systems, and a High Voltage battery that is used to power the propulsion motor and recharge the 12-volt battery.

## Hybrid Vehicles

High Voltage parts and High Voltage wires in this vehicle are sheathed in electromagnetic shielding material; therefore, the amount of electromagnetic waves emitted is no more greater than those emitted by household appliances or the electrical parts in conventional vehicles.

## Sounds Unique to the e:PHEV

When you first start driving this vehicle, you likely will hear some unfamiliar sounds, particularly when you first turn on the power system, while driving, and just after parking. Some of these sounds are unique to this vehicle's powertrain, fuel, and climate control systems; others are similar to sounds generated by conventional automobiles that typically are masked by louder noises absent from a vehicle of this design. These sounds are not a cause for concern, and you will soon recognise them as normal and thus be able to detect any new or unusual noise should one develop.

## e Button

### AUTO Mode

When driving, your vehicle is propelled exclusively by the electric motor, exclusively by the petrol engine, or by a combination of the two. The system selects which propulsion source is most appropriate and automatically switches to it.

### EV Mode

When **EV** mode is activated, your vehicle is propelled exclusively by the electric motor. When you press the **e** button and select **EV** mode, **EV** mode is enabled and the **EV** mode indicator comes on. When you press the **e** button you can select a mode to change to, and the indicator for the selected mode comes on.

Shifts in vehicle or driving conditions may automatically cancel **EV** mode and/or keep the system from manually switching into **EV** mode. When this happens, the beeper sounds and a message appears on the driver information interface.

### CHARGE Mode

When **CHARGE** mode is activated, the engine starts and the High Voltage battery begins charging.

When you press and hold the **e** button, **CHARGE** mode is enabled and the **CHARGE** mode indicator comes on. When you press and hold the **e** button again and select **AUTO** mode, the **AUTO** mode indicator comes on. By pressing the **e** button, you can select a mode to change to, and the indicator for the selected mode will come on.

Shifts in vehicle or driving conditions may automatically cancel **CHARGE** mode and/or keep the system from manually switching into **CHARGE** mode. When this happens, the beeper sounds, and a message appears on the driver information interface. Even when in **CHARGE** mode, the battery charge may decrease in demanding situations such as driving up a hill.

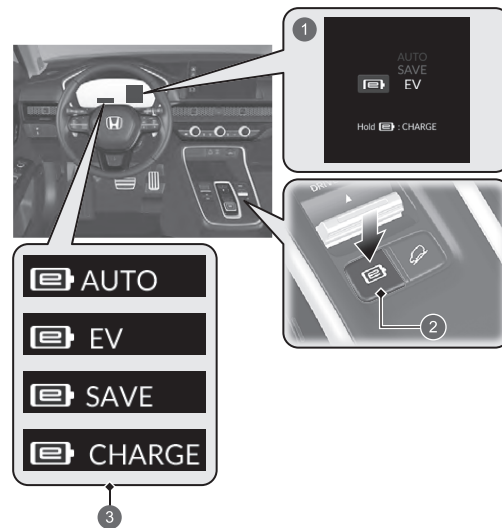

- ① Driver Information Interface
- ② e Button
- ③ AUTO/EV/SAVE/CHARGE Mode Indicator

## **SAVE Mode**

When **SAVE** mode is activated, the system prioritizes using the engine and conserves the High Voltage battery's remaining charge.

When you press the **e** button and select **SAVE** mode, **SAVE** mode is enabled and the **SAVE** mode indicator comes on. When you press the **e** button you can select a mode to change to, and the indicator for the selected mode comes on.

Shifts in vehicle conditions may automatically cancel **SAVE** mode and/or keep the system from manually switching into **SAVE** mode. When this happens, the beeper sounds and a message appears on the driver information interface.

## Safety Precautions



### Do not touch the High Voltage system

Attempting to take a system component apart or disconnect one of its wires can cause severe electrical shock. If the High Voltage system is in need of maintenance or repair, make sure that the maintenance or repair is carried out by a dealer.

### If a crash occurs

- Be careful of electric shock hazard.
  - ▶ If a severe crash damages your vehicle's High Voltage system, there is a possibility of electrical shock due to exposed High Voltage components or wires. If this happens, do not touch any of the High Voltage system components or any of its orange wires.
- Avoid contact with High Voltage battery fluid.
  - ▶ The High Voltage battery contains a flammable electrolyte that can leak as a result of a severe crash. Avoid any skin or eye contact with the electrolyte as it is corrosive. If you accidentally come into contact with the electrolyte, rinse the exposed skin or flush your eyes with copious amounts of water for at least five minutes, then seek medical attention immediately.
- Use a fire extinguisher for an electrical fire.
  - ▶ Attempting to extinguish an electrical fire with even a small quantity of water can be dangerous.
- Anytime the vehicle is damaged in a crash, have it repaired by a dealer.

### Emergency Shutdown System for the High Voltage System

If the vehicle is involved in a crash, the emergency shutdown system will activate depending on the severity of the impact. When the system activates, the High Voltage system automatically shuts down, and the vehicle can no longer move under its own power. To return the High Voltage system back to normal operation, consult a dealer.

### When the vehicle is disposed

- The High Voltage battery is a Lithium ion battery. Honda collects and recycles used High Voltage batteries - consult with your dealer for proper battery disposal in the event your vehicle is not repairable.

# Safe Driving

↔ P.43

## Airbags

↔ P.62

- Your vehicle is fitted with airbags to help to protect you and your passengers during a moderate-to-severe collision.

## Child Safety

↔ P.85

- All children 12 and younger should be seated in the rear seat.
- Small children should be properly restrained in a front-facing child restraint system.
- Infants must be properly restrained in a rear-facing child restraint system on a rear seat.

## Exhaust Gas Hazard

↔ P.113

- Your vehicle emits dangerous exhaust gases that contain carbon monoxide. Do not run the engine in confined spaces where carbon monoxide gas can accumulate.

## Seat Belts

↔ P.49

- Fasten your seat belt and sit upright well back in the seat.
- Check that your passengers are wearing their seat belts correctly.

## Before Driving Checklist

↔ P.48

- Before driving, check that the front seats, head restraints, steering wheel, and mirrors have been properly adjusted.

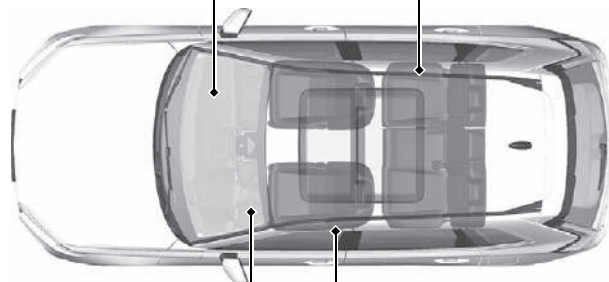

Fasten your lap belt as low as possible.

# Instrument Panel [↔ P.115](#)

## Indicators [↔ P.116](#) / Gauges [↔ P.157](#) / Driver Information Interface [↔ P.138](#) / Head-Up Display\* [↔ P.179](#)

- You can change the gauge design.  
Change gauge design [↔ P.162](#)

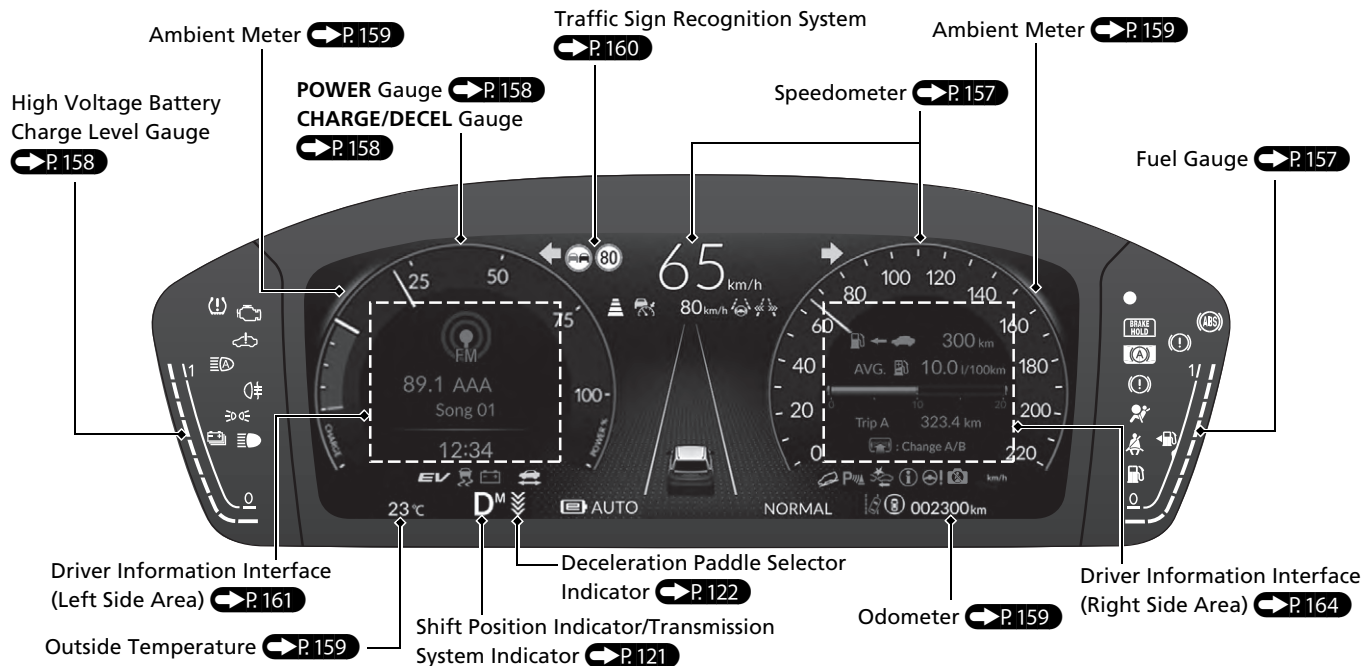
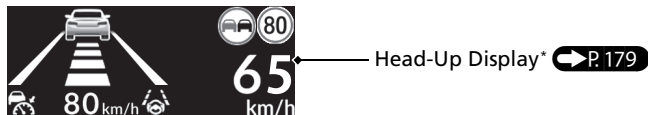

\* Not available on all models

# Controls P.187

## Clock P.188

You can adjust the clock and customize the clock display.

 P.309

## POWER Button P.227

Press the button to change the vehicle's power mode.



## Turn Signals P.231

Turn Signal Control Lever



## Lights P.229

Light Control Switches

High Beam

Low Beam



## Wipers and Washers

 P.241

Wiper/Washer Control Lever

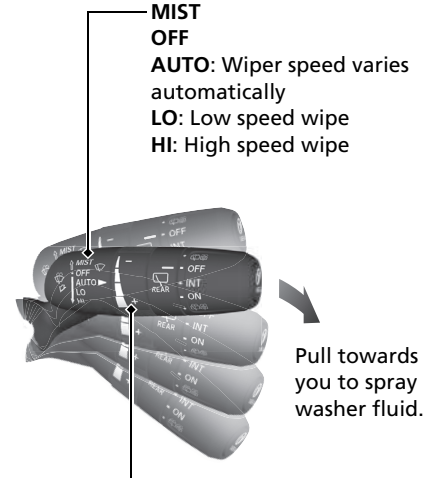

Adjustment Ring

: Low sensitivity

: High sensitivity

**AUTO** should always be turned **OFF** before the following situations in order to prevent severe damage to the wiper system:

- Cleaning the windscreen
- Driving through a car wash
- No rain present

## Steering Wheel P.247

- To adjust, push the adjustment lever down, adjust to the desired position, then lock the lever back in place.

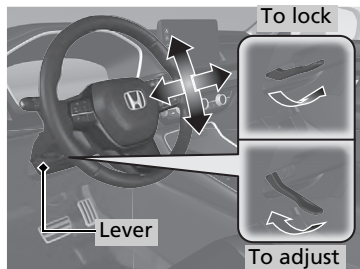

## Unlocking the Front Doors from the Inside

 P.200

- Pull either front door inner handle to unlock and open it at the same time.

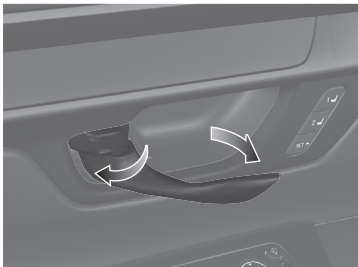

## Tailgate P.202

- Press the outer handle to unlock and open the tailgate when you carry the keyless remote on you.
- Press the power tailgate button on the driver side control panel.
- Press the power tailgate button on the remote transmitter.

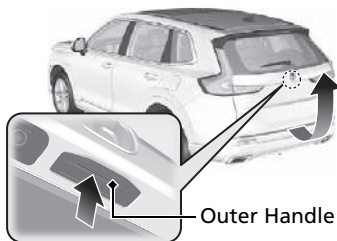

With the keyless remote on you, raise and lower your foot (in a kicking motion) under the centre of the rear bumper to open or close the tailgate.

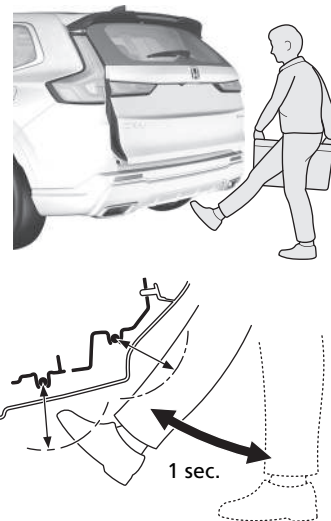

## Power Door Mirrors

➔ P.249

- With the power mode in ON, move the selector switch to **L** or **R**.
- Push the appropriate edge of the adjustment switch to adjust the mirror.
- Press the folding button to fold in and out the door mirrors.

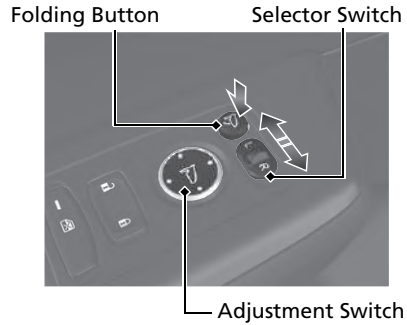



## Power Windows ➔ P.220

- With the power mode in ON, open and close the power windows.
- If the power window lock button is in the off position, each passenger's window can be opened and closed with its own switch.
- If the power window lock button is in the ON position (indicator on), each passenger's window switch is disabled.

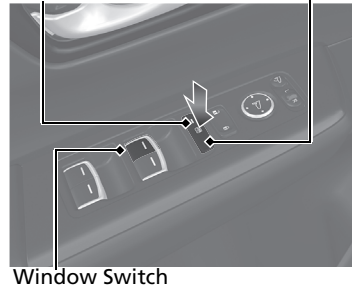
Indicator      Power Window Lock Button



# Climate Control System P. 283

- Press the **AUTO** button to activate the climate control system.
- Press the  button to turn the system on or off.
- Press the  button to defrost the windscreen.

Left-hand Drive Type

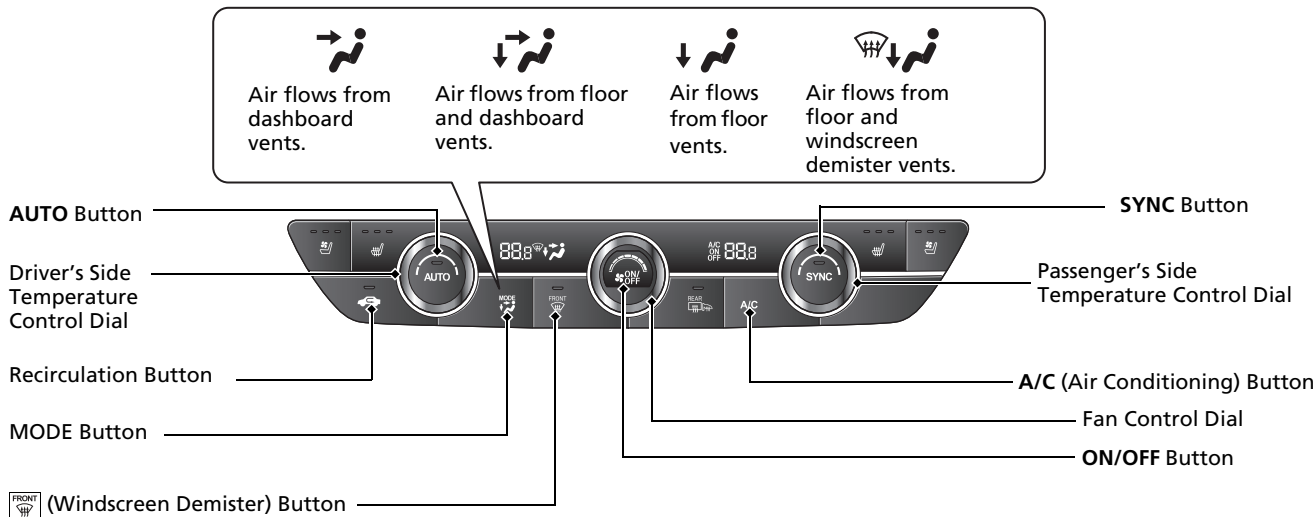

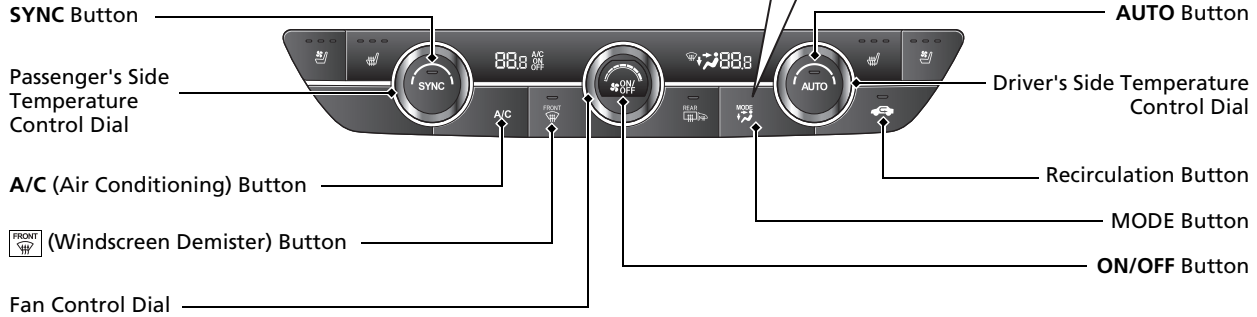

# Features P. 289

## Audio System P. 290, 292

For navigation system operation  See the Navigation System Manual

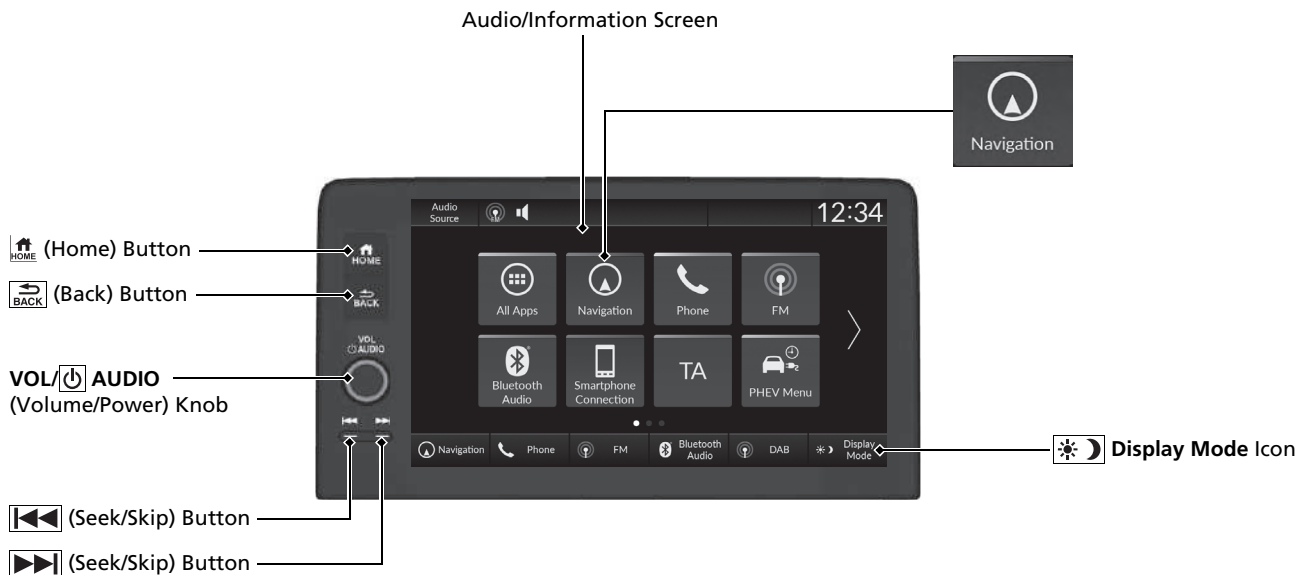

## Audio Remote Controls

➔ P.296

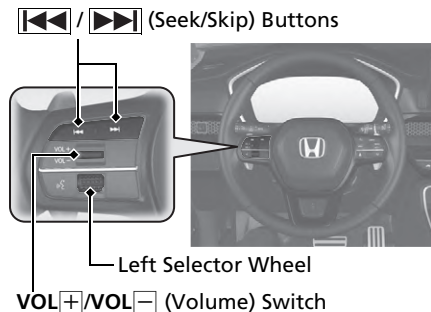

**VOL+** / **VOL-** (Volume) Switch

- **VOL+** / **VOL-** (Volume) Switch  
Press to adjust the volume up/down.
- **⏮** / **⏭** (Seek/Skip) Buttons  
Radio:  
Press **⏮** / **⏭** to change the preset radio station. Press and hold **⏮** / **⏭** to change the strong station.  
Wired connection, USB flash drive, *Bluetooth*® Audio, or Smartphone Connection:  
Press **⏮** / **⏭** to skip to the beginning of the next song or return to the beginning of the current song.  
USB flash drive:  
Press and hold **⏮** / **⏭** to change a folder.

- **Left Selector Wheel**  
Roll up or down:  
To cycle through the audio modes, roll up or down and then press the left selector wheel.

# Driving P.415

## Transmission P.433

- Select **P** and depress the brake pedal when turning on the power.

### Shift Operation

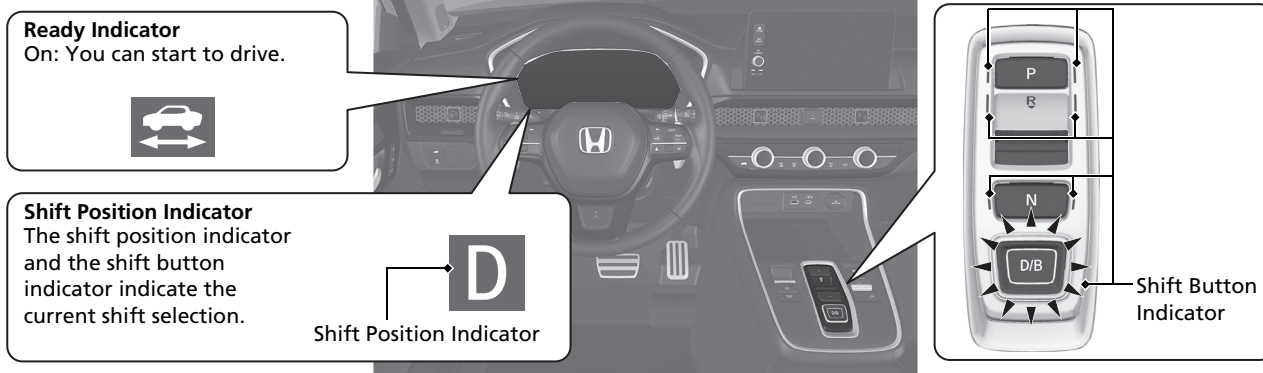

**Ready Indicator**  
On: You can start to drive.



**Shift Position Indicator**  
The shift position indicator and the shift button indicator indicate the current shift selection.

**D**  
Shift Position Indicator

**P**  
**R**  
**N**  
**D/B**  
Shift Button Indicator



**P** **Parking**  
Press the **P** button.  
Used when parking or turning the power on or off.

**R** **Reverse**  
Press back the **R** button.  
Used when reversing.

**N** **Neutral**  
Press the **N** button.  
Transmission is not locked.

**D/B** **Drive/B Position**  
Each time you press the **D/B** button, the mode switches between Drive and **B** Position mode.

#### **Drive**

- Used for normal driving.
- The deceleration paddle selector can be used temporarily.
- The deceleration paddle selector can be used when **SPORT** mode is ON.

#### **B Position**

- Used when driving down a long hill and to increase regenerative braking.
- The deceleration paddle selector can be used.

## Deceleration Paddle Selector P. 440

When you release the accelerator pedal, you can control the rate of deceleration without releasing your hands from the steering wheel. Using the deceleration paddle selector situated on the steering wheel, you can sequentially shift through four stages of deceleration.

- **When shift position is in **

If you pull back the paddle selector, the rate of deceleration will change temporarily, and the stage will appear on the gauge.

- **When shift position is in  and SPORT mode is ON or when shift position is in **

If you pull back the paddle selector, the rate of deceleration will change and the stage along with **M** will appear on the gauge.

 Paddle Selector





 Paddle Selector



When shift position is in , the deceleration stage appears.



When shift position is in  and **SPORT** mode is ON or when shift position is in , the deceleration stage and **M** appear.





Deceleration stage



## Adjustable Speed Limiter

➔ P. 454

This system enables you to set a maximum speed that cannot be exceeded even if you are depressing the accelerator pedal.

- To use the adjustable speed limiter, press the  button. Select the adjustable speed limiter by pressing the  button, then press the **RES/+ / SET / -** switch up or down when your vehicle reaches the desired speed.
- The vehicle speed limit can be set from 30 km/h (18 mph) to 250 km/h (156 mph).

## VSA On and Off ➔ P. 467

- The Vehicle Stability Assist (VSA) system helps to stabilise the vehicle during cornering, and helps to maintain traction while accelerating on loose or slippery road surfaces.
- VSA comes on automatically every time you turn the power system on.
- The VSA function can be partially disabled or fully restored in VSA settings using the driver information interface.

➔ **Vehicle Stability Assist Mode**

➔ P. 176

## Deflation Warning System ➔ P. 469

- Detects a change in tyre conditions and overall dimensions due to decrease in tyre pressures.
- The Deflation Warning System is turned on automatically every time you turn the power system on.
- A calibration procedure must be performed when certain conditions arise.

## CMBS On and Off ➔ P. 489

- When a possible frontal collision is likely unavoidable, the CMBS can reduce the vehicle speed and the severity of the collision.
- The CMBS is turned on every time you turn the power system on.
- To turn the CMBS on or off, use the safety support of the driver information interface.

## Refueling P.651

**Fuel recommendation:** EN 228 standards petrol/gasohol fuel  
Unleaded premium petrol/gasohol up to E10 (90% petrol and 10% ethanol), research octane number 95 or higher

**Fuel tank capacity:** 46.5 L (10.2 Imp gal)

- 1 Press the fuel fill door release button.  
▶ **Please wait** appears for a few seconds on the driver information interface.



- 2 When the message changes to **Ready**, the fuel fill door automatically opens.

- 3 Turn the fuel fill cap slowly to remove the cap.

- 4 Place the cap in the holder on the fuel fill door.

- 5 After refueling, screw the cap back on until it clicks at least once.

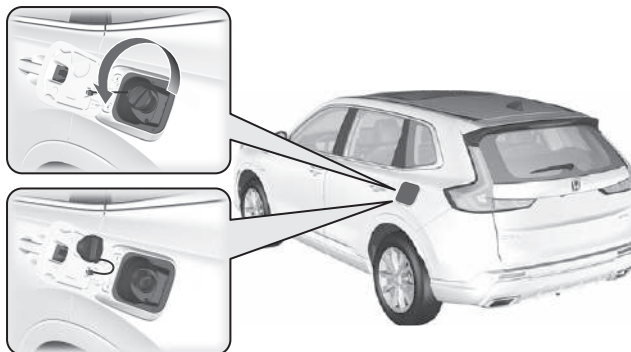

# Honda SENSING 360 P. 479

Assists with functions such as acceleration, braking, and steering in order to reduce the burden on the driver, as well as help to avoid or reduce the severity of collisions.

Honda SENSING 360 has the following functions.

## Collision Mitigation Braking System (CMBS)

 P. 484

The system can assist you when it determines there is a possibility of your vehicle colliding with a vehicle (including motorcycles) ahead from behind, an oncoming vehicle in front, a vehicle approaching from the side, a pedestrian, or someone riding a bicycle (moving bicycle). The CMBS is designed to alert you when the potential for a collision is determined, as well as assist in reducing speed, avoiding collisions, and reducing collision severity.

## Low Speed Braking Control P. 498

Using sonar sensors located on the front and rear bumpers, this system can detect if there is danger of a potential collision with a wall or other obstacle during normal driving or when the accelerator pedal is depressed with too much force. The system then assists in avoiding collisions and reducing damage from impact through Low Speed Brake function and/or Collision Mitigation Throttle Control and Rear Collision Mitigation Throttle Control.

## Front Cross Traffic Warning P. 504

Alerts you when the radar sensor or sensor camera detects a vehicle crossing in front of you.

## Road Departure Mitigation System P. 510

Alerts and helps to assist you when the system detects a possibility of your vehicle crossing over detected lane markings, or approaching the outer edge of the pavement (into grass or gravel road shoulder) or a detected oncoming vehicle.

## Lane Change Collision Mitigation P. 518

When you change lanes, the system gives visual and audible alerts, along with steering assistance, if it detects the risk of a vehicle colliding with yours from a rear corner.

## Adaptive Cruise Control (ACC) with Low Speed Follow P. 526

Helps to maintain a constant vehicle speed and a set following-interval behind a vehicle detected ahead of yours and, if the detected vehicle comes to a stop, can decelerate and stop your vehicle, without you having to keep your foot on the brake or the accelerator.

## Intelligent Speed Limiter P. 460

Automatically sets the speed limit that the traffic sign recognition system detects. And the speed limit cannot be exceeded even if you are depressing the accelerator pedal. If you fully depress the accelerator the speed limit can be exceeded.

## Lane Keeping Assist System (LKAS) P. 550

Provides steering input to help to keep the vehicle in the middle of a detected lane and provides tactile, audible and visual alerts if the vehicle is detected drifting out of its lane.

## Traffic Jam Assist P. 561

The Traffic Jam Assist system uses a camera mounted to the upper portion of the windscreen to detect and monitor left and right white (or yellow) traffic lane lines. Based on inputs from the camera, the system can apply steering torque to keep your vehicle in the centre of the detected lane.

## Active Lane Change Assist P. 570

Assists with steering when you operate the turn signal lever to change lanes on motorways.

## Traffic Sign Recognition System P. 576

Reminds you of road sign information, such as the current speed limit and that overtaking is prohibited, and notifies you if your vehicle is exceeding the speed limit.

## Adaptive Driving Beam\* P. 238

When driving at night, the front sensor camera detects light sources such as street lights or the lights of an oncoming or preceding vehicle. The system automatically switches the headlights between low and high beam depending on the situation. In addition, the system automatically adjusts the light distribution of the high beams in order to reduce glare for preceding and oncoming vehicles.

## Blind Spot Information System P. 471

When the system detects vehicles approaching from behind in adjacent lanes, the appropriate indicator comes on, providing assistance when you change lanes.

## Parking Sensor System P. 602

The corner, side and centre sensors monitor obstacles around your vehicle, and the beeper, driver information interface and audio/information screen let you know the approximate distance between your vehicle and the obstacle.

## Cross Traffic Monitor P. 607

Monitors the rear corner areas using the radar sensors when reversing, and alerts you if a vehicle approaching from a rear corner is detected.

The system is convenient when you are backing out of a parking space.

## Honda Parking Pilot P. 626

Assists with parking and exit.

Cameras and sonar sensors will detect any parking spaces and set a route for parking in or pulling out of a space. The system will then help you park in or exit the space by adjusting your speed, moving the steering wheel, and changing the shift position.

## Driver Attention Monitor P. 525

The Driver Attention Monitor detects the driver's condition using the driver monitoring camera, and then depending on the situation will recommend caution or a break. If you feel sleepy or fatigued, stop in a safe location and rest for as long as needed.

# Maintenance ↔ P.671

## Under the Bonnet ↔ P.689

- Check engine oil, engine coolant, high voltage battery system coolant, and windscreen washer fluid. Add when necessary.
- Check brake fluid.
- Check the 12-volt battery condition monthly.

- 1 Pull the bonnet release handle under the driver's side lower outside corner of the dashboard.

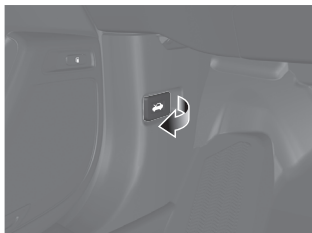

- 2 Locate the bonnet latch lever, push it to the side, and then raise the bonnet. Once you have raised the bonnet slightly, you can release the lever.



- 3 When finished, close the bonnet and make sure it is firmly locked in place.

## Wiper Blades ↔ P.706

- Replace blades if they leave streaks across the windscreen or become noisy.



## Tyres ↔ P.710

- Inspect tyres and wheels regularly.
- Check tyre pressures regularly.
- Install winter tyres for winter driving.

## Lights ↔ P.703

- Inspect all lights regularly.

# Handling the Unexpected P.735

## Flat Tyre P.736

- Park in a safe location and repair the flat tyre using the tyre repair kit in the luggage area.



## Power System Won't Start P.749

- If the 12-volt battery is dead, jump start using a booster battery.

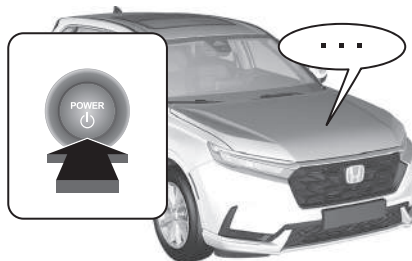

## Overheating P.755

- Park in a safe location. If you do not see steam under the bonnet, open the bonnet, and let the power system cool down.



## Indicators Come On P.757

- Identify the indicator and consult the owner's manual.



## Blown Fuse P.764

- Check for a blown fuse if an electrical device does not operate.

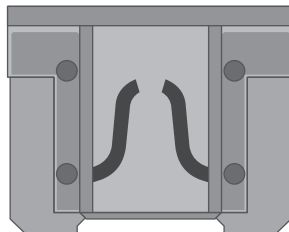

## Emergency Towing P.771

- Call a professional towing service if you need to tow your vehicle.



# What to Do If

**Q** Why does the brake pedal pulsate slightly when applying the brakes?

**A** This can occur when the ABS activates and does not indicate a problem. Apply firm, steady pressure on the brake pedal. Never pump the brake pedal.

➤ Anti-lock Brake System (ABS) ➔ P.597

**Q** The rear door cannot be opened from inside the vehicle. Why?

**A** Check if the childproof lock is in the lock position. If so, open the rear door with the outside door handle. To cancel this function, slide the lever up to the unlock position.

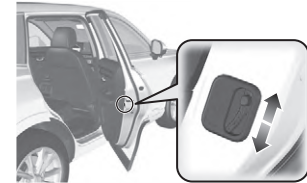

**Q** Why do the doors lock after I unlocked the doors?

**A** If you do not open the doors within 30 seconds, the doors are relocked automatically for security.

**Q** Why does the beeper sound when I open the driver's door?

**A** The beeper sounds when:

- The power mode is in ACCESSORY.
- The exterior lights are left on.

**Q** Why does the beeper sound when I start driving?

**A** The beeper sounds when the driver and/or front passenger are not wearing their seat belts.

**Q** Pressing the electric parking brake switch does not release the parking brake. Why?

**A** Press the electric parking brake switch with the brake pedal depressed.

**Q** I'm seeing an amber indicator of a tyre with an exclamation point. What is that?

**A** The Deflation Warning System needs attention. If you recently inflated or changed a tyre, you have to recalibrate the system.  
➤ Deflation Warning System ➔ P. 469

**Q** Depressing the accelerator pedal does not release the parking brake automatically. Why?

**A**

- Fasten the driver's seat belt.
- Check if the transmission is in **P** or **N**. If so, select any other position.

**Q** Why does the shift position automatically change to **P** when I open the driver's door to check for parking space lines when reversing?

**A**

- Fasten the driver's seat belt.
- Close the driver's door and manually change the shift position.  
➤ When opening the driver's door ➔ P. 437



**Why do I hear a screeching sound when I apply the brake pedal?**



The brake pads may need to be replaced. Have your vehicle inspected by a dealer.



**Is it possible to use unleaded petrol with a Research Octane Number (RON) of 91 or higher on this vehicle?**



Your vehicle is designed to operate on premium unleaded petrol with a research octane of 95 or higher. If this octane grade is unavailable, regular unleaded petrol with a research octane of 91 or higher may be used temporarily. The use of regular unleaded petrol can cause metallic knocking noises in the engine and will result in decreased engine performance. The long-term use of regular-grade petrol can lead to engine damage.

---



# Safe Driving

You can find many safety recommendations throughout this chapter, and throughout this manual.

## **For Safe Driving**

Important Safety Precautions.....	44
Important Handling Information.....	46
Your Vehicle's Safety Features.....	47
Safety Checklist .....	48

## **Seat Belts**

About Your Seat Belts .....	49
Fastening a Seat Belt .....	54
Seat Belt Inspection.....	60
Anchorage Points.....	61

## **Airbags**

Airbag System Components.....	62
-------------------------------	----

Types of Airbags .....	64
Front Airbags (SRS) .....	64
Knee Airbags .....	70
Centre Airbag .....	74
Side Airbags.....	76
Side Curtain Airbags .....	79
Airbag System Indicators.....	81
Airbag Care .....	83

## **Post-Collision Braking System**

About Post-Collision Braking System ...	84
---	----

## **Child Safety**

Protecting Child Passengers .....	85
-----------------------------------	----

Safety of Infants and Small Children ....	88
Safety of Larger Children .....	110
<b>Exhaust Gas Hazard</b>	
Carbon Monoxide Gas.....	113
<b>Safety Labels</b>	
Label Locations .....	114

The following pages explain your vehicle's safety features and how to use them properly. The safety precautions below are ones that we consider to be among the most important.

## Important Safety Precautions

### ■ Always wear your seat belt

A seat belt is your best protection in all types of collisions. Airbags are designed to supplement seat belts, not replace them. So even though your vehicle is equipped with airbags, make sure you and your passengers always wear your seat belts, and wear them properly.

### ■ Restrain all children

Children aged 12 and under should ride properly restrained in a back seat, not the front seat. Infants and small children should be restrained in a child restraint system. Larger children should use a booster seat and a lap/shoulder seat belt until they can use the belt properly without a booster seat.

### ■ Be aware of airbag hazards

While airbags can save lives, they can cause serious or fatal injuries to occupants who sit too close to them, or are not properly restrained. Infants, young children, and short adults are at the greatest risk. Be sure to follow all instructions and warnings in this manual.

### ■ Don't drink and drive

Alcohol and driving don't mix. Even one drink can reduce your ability to respond to changing conditions, and your reaction time gets worse with every additional drink. So don't drink and drive, and don't let your friends drink and drive, either.

### ▣ Important Safety Precautions

Some countries prohibit the use of mobile phones other than hands-free devices by the driver while driving.

**■ Pay appropriate attention to the task of driving safely**

Engaging in mobile phone conversation or other activities that keep you from paying close attention to the road, other vehicles, and pedestrians could lead to a crash. Remember, situations can change quickly, and only you can decide when it is safe to divert some attention away from driving.

**■ Control your speed**

Excessive speed is a major factor in crash injuries and deaths. Generally, the higher the speed, the greater the risk, but serious injuries can also occur at lower speeds. Never drive faster than is safe for current conditions, regardless of the maximum speed posted.

**■ Keep your vehicle in safe condition**

Having a tyre blowout or a mechanical failure can be extremely hazardous. To reduce the possibility of such problems, check your tyre pressures and condition frequently, and perform all regularly scheduled maintenance.

**■ Do not leave children unattended in the vehicle**

Children, pets, and people needing assistance left unattended in the vehicle may be injured if they activate one or more of the vehicle controls. They may also cause the vehicle to move, resulting in a crash in which they and/or another person(s) can be injured or killed. Also, depending on the ambient temperature, the temperature of the interior may reach extreme levels, which can result in harm or death. Even if the climate control system is on, never leave them in the vehicle unattended as the climate control system can shut off at any time.

**■ Handle high-voltage with care**

Familiarize yourself with the charging instructions and warnings supplied in this manual. If using a public charger, also observe the charging station manufacturer's instructions.

## Important Handling Information

Your vehicle has higher ground clearance than a passenger vehicle designed for use only on pavement. Higher ground clearance has many advantages for off-road driving. It allows you to travel over bumps, obstacles, and rough terrain. It also provides good visibility so you can anticipate problems earlier.

These advantages come at some cost. Because your vehicle is taller and rides higher off the ground, it has a higher centre gravity making it more susceptible to tipping or rollover if you make abrupt turns. Utility vehicles have a significantly higher rollover rate than other types of vehicles. In a rollover crash, an unbelted person is significantly more likely to die than a person wearing a seat belt. As a reminder, make sure you and your passengers always wear seat belts.

### ► Important Handling Information

For information on how to reduce the risk of rollover, read:

- **Precautions While Driving** P. 431
- **Off-road Guidelines** P. 426

Failure to operate your vehicle correctly might result in a crash or a rollover.

In many countries, the law prohibits off-road driving, e.g., driving in forests, trailblazing, etc. Please check your local laws and regulations before commencing any off-road driving activity.

## Your Vehicle's Safety Features

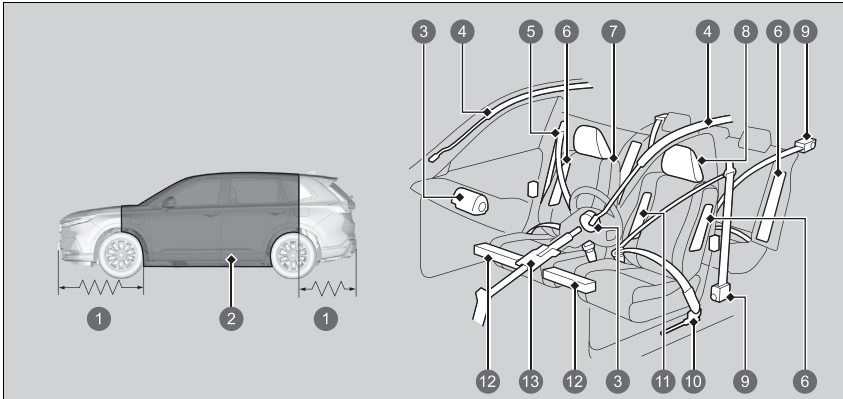

- ① Crush Zones
- ② Safety Cage
- ③ Front Airbags
- ④ Side Curtain Airbags
- ⑤ Seat Belts
- ⑥ Side Airbags
- ⑦ Seats and Seat-Backs
- ⑧ Head Restraints
- ⑨ Seat Belt Tensioners
- ⑩ Outer Lap Pretensioners
- ⑪ Centre Airbag
- ⑫ Knee Airbag
- ⑬ Collapsible Steering Column

The following checklist will help you take an active role in protecting yourself and your passengers.

### ► Your Vehicle's Safety Features

Your vehicle is equipped with many features that work together to help to protect you and your passengers during a crash.

Some features do not require any action on your part. These include a strong steel framework that forms a safety cage around the passenger compartment, front and rear crush zones, a collapsible steering column, and tensioners that tighten the front and rear outer seat belts in a sufficient crash.

However, you and your passengers cannot take full advantage of these features unless you remain seated in the correct position and always wear your seat belts. In fact, some safety features can contribute to injuries if they are not used properly.

## Safety Checklist

For the safety of you and your passengers, make a habit of checking these items each time before you drive. Check if the charging cable is connected to the vehicle and disconnect it if it is. The vehicle will not operate with the cable connected.

- Adjust your seat to a position suitable for driving. Be sure the front seats are adjusted as far to the rear as possible while allowing the driver to control the vehicle. Sitting too close to a front airbag can result in serious or fatal injury in a crash.
  - ▣ **Seats** P. 251
- Adjust head restraints to the proper position. Head restraints are most effective when the centre of the head restraint aligns with the centre of your head. Taller persons should adjust their head restraint to the highest position.
  - ▣ **Adjusting the Front Head Restraint Positions** P. 259
- Always wear your seat belt, and make sure you wear it properly. Confirm that any passengers are properly belted as well.
  - ▣ **Fastening a Seat Belt** P. 54
- Protect children by using seat belts or child restraint systems according to a child's age, height, and weight.
  - ▣ **Child Safety** P. 85

### ▣ Safety Checklist

If the door and/or tailgate open message appears on the driver information interface, a door and/or the tailgate is not completely closed. Close all doors and the tailgate tightly until the message disappears.

- ▣ **Driver Information Interface Warning and Information Messages** P. 138

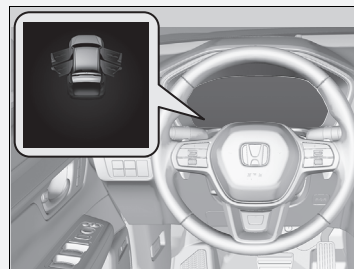

## About Your Seat Belts

Seat belts are the single most effective safety device because they keep you connected to the vehicle so that you can take advantage of many built-in safety features. They also help to keep you from being thrown against the inside of the vehicle, against any passengers, or out of the vehicle. When worn properly, seat belts also keep your body properly positioned in a crash so that you can take full advantage of the additional protection provided by the airbags.

In addition, seat belts help to protect you in almost every type of crash, including:

- frontal impacts
- side impacts
- rear impacts
- rollovers

### ⓘ About Your Seat Belts

#### **WARNING**

**Not wearing a seat belt properly increases the chance of serious injury or death in a crash, even though your vehicle has airbags.**

**Be sure you and your passengers always wear seat belts and wear them properly.**

**WARNING:** Seat belts are designed to bear upon the bony structure of the body, and should be worn low across the front of the pelvis or the pelvis, chest and shoulders, as applicable; wearing the lap section of the belt across the abdominal area must be avoided.

**WARNING:** Seat belts should be adjusted as firmly as possible, consistent with comfort, to provide the protection for which they have been designed. A slack belt will greatly reduce the protection afforded to the wearer.

**WARNING:** Belts should not be worn with straps twisted.

**WARNING:** Each belt assembly must only be used by one occupant; it is dangerous to put a belt around a child being carried on the occupant's lap.

## ■ Lap/shoulder seat belts

All five seating positions are equipped with lap/shoulder seat belts with emergency locking retractors. In normal driving, the retractor lets you move freely while keeping some tension on the belt. During a collision or sudden stop, the retractor locks to restrain your body.

The seat belt must be properly secured when using a front-facing child restraint system.

➤ **Installing a Child Restraint System with a Lap/Shoulder Seat Belt** P. 106

## ■ Proper use of seat belts

Follow these guidelines for proper use:

- All occupants should sit upright, well back in the seat, and remain in that position for the duration of the trip. Slouching and leaning reduce the effectiveness of the belt and can increase the chance of serious injury in a crash.
- Never place the shoulder part of a lap/shoulder seat belt under your arm or behind your back. This could cause very serious injuries in a crash.
- Two people should never use the same seat belt. If they do, they could be very seriously injured in a crash.
- Do not put any accessories on the seat belts. Devices intended to improve comfort or reposition the shoulder part of a seat belt can reduce the protective capability and increase the chance of serious injury in a crash.

## ➤ About Your Seat Belts

If you extend the seat belt too quickly, it will lock in place. If this happens, slightly retract the seat belt, then extend it slowly.

Seat belts cannot completely protect you in every crash. But in most cases, seat belts can reduce your risk of serious injury.

Most countries require you to wear seat belts. Take time to familiarise with the legal requirements of the countries in which you will drive.

## Seat Belt Reminder



### Front seats

The seat belt system includes an indicator on the instrument panel to remind the driver or a front passenger or both to fasten their seat belts.

If you set the power mode to ON and a seat belt is not fastened, the indicator will come on. If the driver or front passenger does not fasten the belt, the indicator will remain on.

The beeper will periodically sound and the indicator will blink while the vehicle is moving until the seat belt is fastened.

### Seat Belt Reminder

The indicator will also come on if a front passenger does not fasten their seat belt within six seconds after the power mode is set to ON.

When no one is sitting in the front passenger's seat, the indicator will not come on and the beeper will not sound.

If the indicator comes on or the beeper sounds with no one sitting in the front passenger's seat. Check if:

- There is nothing heavy placed on the front passenger seat.
- The driver's seat belt is fastened.

If the indicator does not light when the passenger is seated and is not fastened, something may be interfering with the occupant detection sensor.

Check if:

- A cushion is placed on the seat.
- The front passenger is not sitting properly.

If none of these conditions exist, have your vehicle checked by a dealer.

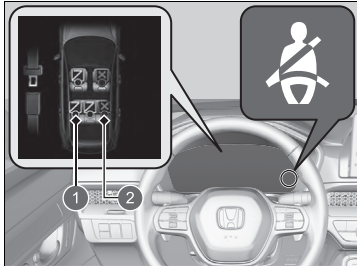

- 1 Fastened
- 2 Unfastened

### ■ Rear seats

Your vehicle monitors rear seat belt use. The driver information interface notifies you about the status of the rear seat belts use.

The display appears when:

- Any of the rear passenger seat belts are unfastened when the power mode is set to ON.
- Any of the rear passengers fasten or unfasten their seat belt.

The seat belt reminder indicator blinks and the beeper sounds if any rear passenger seat belts has been unfastened while driving.

## Automatic Seat Belt Tensioners

The front seats and the outer rear seats are equipped with automatic seat belt tensioners to enhance safety.

The tensioners automatically tighten the front seat belts and the outer rear seat belts during a moderate-to-severe frontal collision, sometimes even if the collision is not severe enough to inflate the front airbags or the front knee airbags.

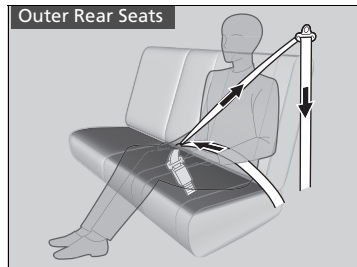
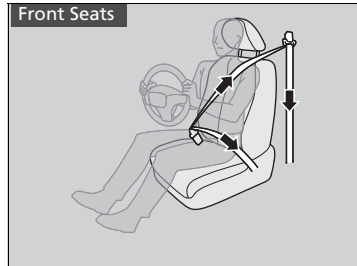

### Automatic Seat Belt Tensioners

The seat belt tensioners can only operate once. If a tensioner is activated, the SRS indicator will come on. Have a dealer replace the tensioner and thoroughly inspect the seat belt system as it may not offer protection in a subsequent crash.

During a moderate-to-severe side impact, the tensioners on both sides of the vehicle also activate.

## Fastening a Seat Belt

After adjusting a front seat to the proper position, and while sitting upright and well back in the seat (see illustrations for correct seating posture):

➤ **Seats** P. 251



1. Pull the seat belt out slowly.

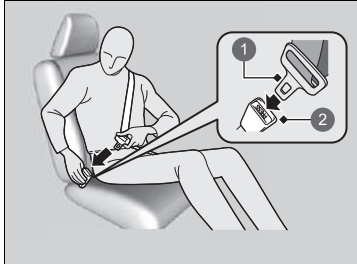

2. Insert the latch plate into the buckle, then tug on the belt to make sure the buckle is secure.

▶ Make sure that the belt is not twisted or caught on anything.

① Latch Plate

② Buckle

### Fastening a Seat Belt

No one should sit in a seat with an inoperative seat belt or one that does not appear to be working correctly. Using a seat belt that is not working properly may not protect the occupant in a crash. Have a dealer check the belt as soon as possible.

If the seat belt appears to be locked in a fully retracted position, firmly pull out on the shoulder belt once, then push it back in. Then, smoothly pull it out of the retractor and fasten. If you are unable to release the seat belt from a fully retracted position, do not allow anyone to sit in the seat, and take your vehicle to a dealer for repair.

➤ **About Your Seat Belts** P. 49

➤ **Seat Belt Inspection** P. 60



3. Position the lap part of the belt as low as possible across your hips (see illustration), then pull up on the shoulder part of the belt so the lap part fits snugly. This lets your strong pelvic bones take the force of a crash and reduces the chance of internal injuries.
4. If necessary, pull up on the belt again to remove any slack, then check that the belt rests across the centre of your chest and over your shoulder. This spreads the forces of a crash over the strongest bones in your upper body.

## ▶▶ Fastening a Seat Belt

**⚠ WARNING**

Improperly positioning the seat belts can cause serious injury or death in a crash.

Make sure all seat belts are properly positioned before driving.

To release the belt, push the red **PRESS** button and then guide the belt by hand until it has retracted completely.

When exiting the vehicle, be sure the belt is properly stowed so that it will not get caught in the closing door.

Never insert any foreign objects into the buckle or retractor mechanism.

## ■ Adjusting the Shoulder Anchorage

The front seats and rear outer seats have adjustable shoulder anchorages to accommodate taller and shorter occupants.

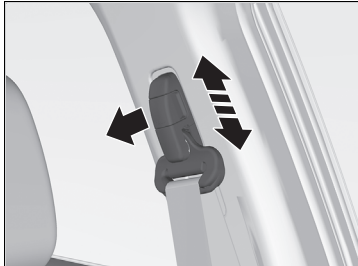

1. Move the anchorage up and down while pulling the shoulder anchorage outward.
2. Position the anchorage so that the belt rests across the centre of your chest and over your shoulder.

## ▣ Adjusting the Shoulder Anchorage

After an adjustment, make sure that the shoulder anchorage position is secure.

The shoulder anchorage height can be adjusted to four levels. If the belt contacts your neck, lower the height one level at a time.

## Seat Belt with Detachable Anchorage

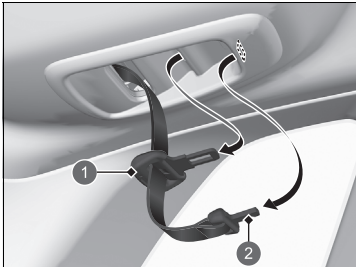

- 1 Latch Plate
- 2 Small Latch Plate

1. Pull out the seat belt's small latch plate and the latch plate from each holding slot in the ceiling.

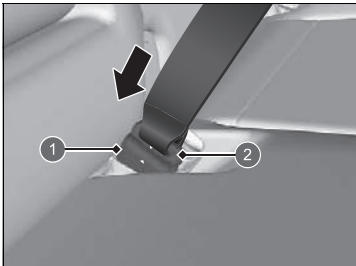

- 1 Anchorage Buckle
- 2 Small Latch Plate

2. Line up the triangle marks on the small latch plate and anchorage buckle. Make sure the seat belt is not twisted. Attach the belt to the anchorage buckle.

### Seat Belt with Detachable Anchorage

## ⚠ WARNING

Using the seat belt with the detachable anchorage unfastened increases the chance of serious injury or death in a crash.

Before using the seat belt, make sure the detachable anchorage is correctly latched.

To unlatch the detachable anchorage, insert the latch plate into the slot on the side of the anchorage buckle.

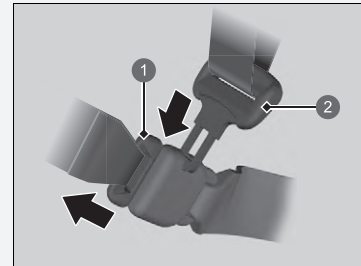

- 1 Small Latch Plate
- 2 Latch Plate

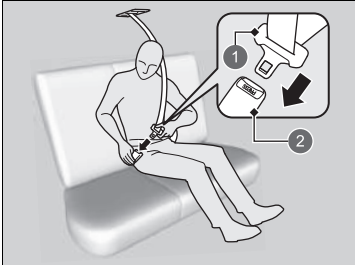

- ① Latch Plate
- ② Buckle

3. Insert the latch plate into the buckle.  
Properly fasten the seat belt the same way  
you fasten the lap/shoulder seat belt.

## Advice for Pregnant Women

### Consider alternative:

If you are pregnant, the best way to protect yourself and your unborn child when driving or riding in a vehicle is to always wear a seat belt. When positioning the seat belt, wear the shoulder belt section across the chest, avoiding the abdomen, and keep the lap belt portion as low as possible across the hips. (See illustration.)



### Advice for Pregnant Women

Each time you have a checkup, ask your doctor if it is okay for you to drive.

To reduce the risk of injuries to both you and your unborn child that can be caused by an inflating front airbag:

- When driving, sit upright and adjust the seat as far back as possible while allowing full control of the vehicle.
- When sitting in the front passenger's seat, adjust the seat as far back as possible.

## Seat Belt Inspection

Regularly check the condition of your seat belts as follows:

- Pull each belt out fully, and look for frays, cuts, burns, and wear.
- Check that the latch plates and buckles work smoothly and the belts retract easily.
  - ▶ If a belt does not retract easily, cleaning the belt may correct the problem. Only use a mild soap and warm water. Do not use bleach or cleaning solvents. Make sure the belt is completely dry before allowing it to retract.

Any belt that is not in good condition or working properly will not provide proper protection and should be replaced as soon as possible.

A belt that has been worn during a crash may not provide the same level of protection in a subsequent crash. Have your seat belts inspected by a dealer after any collision.

### ▶▶ Seat Belt Inspection

#### **WARNING**

**Not checking or maintaining seat belts can result in serious injury or death if the seat belts do not work properly when needed.**

**Check your seat belts regularly and have any problem corrected as soon as possible.**

**WARNING:** No modifications or additions should be made by the user which will either prevent the seat belt adjusting devices from operating to remove slack, or prevent the seat belt assembly from being adjusted to remove slack.

**WARNING:** It is essential to replace the entire assembly after it has been worn in a severe impact even if damage to the assembly is not obvious.

**WARNING:** Care should be taken to avoid contamination of the webbing with polishes, oils and chemicals, and particularly battery acid. Cleaning may safely be carried out using mild soap and water. The belt should be replaced if webbing becomes frayed, contaminated or damaged.

## Anchorage Points

Front Seats

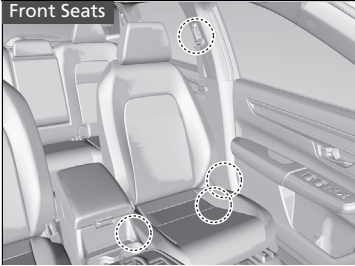

When replacing the seat belts, use the anchorage points shown in the images. The front seat has a lap/shoulder belt.

Rear Seats

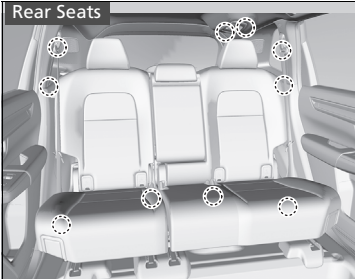

The rear seat has three lap/shoulder belts.

## Airbag System Components

The front, driver's knee, front passenger's knee, side, front centre and side curtain airbags are deployed according to the direction and severity of impact. The airbag system includes:

- Two SRS (Supplemental Restraint System) front airbags. The driver's airbag is stored in the centre of the steering wheel; the front passenger's airbag is stored in the dashboard. Both are marked **SRS AIRBAG**.
- Two knee airbags. The driver's knee airbag is stored under the steering column; the front passenger's knee airbag is stored under the glove box. Both are marked **SRS AIRBAG**.
- Four side airbags, one for the driver, one for the front passenger and two for the rear outboard seating positions. The airbags are stored in the outer edges of the seat-backs. All are marked **SIDE AIRBAG**.
- Two side curtain airbags, one for each side of the vehicle. The airbags are stored in the ceiling, above the side windows. The front and rear pillars are marked **SIDE CURTAIN AIRBAG**.
- One centre airbag. The airbag is stored in the centre side of driver's seat-back. It is marked **CENTER AIRBAG**.
- An electronic control unit that, when the power mode is in ON, continually monitors information about the various impact sensors, seat and buckle sensors, airbag activators, seat belt tensioners, and other vehicle information. During a crash event the unit can record such information.
- Automatic seat belt tensioners for the front seats and outer rear seats.
- Impact sensors that can detect a moderate-to-severe front or side impact.
- An indicator on the console panel that alerts you that the front passenger's front airbag has been turned off.
- An indicator on the instrument panel that alerts you to a possible problem with your airbag system or seat belt tensioners.
- Pressure sensors that can detect a moderate-to-severe side impact.

## ■ Important Facts About Your Airbags

Airbags can pose serious hazards. To do their job, airbags must inflate with tremendous force. So, while airbags help to save lives, they can cause burns, bruises, and other minor injuries, sometimes even fatal ones if occupants are not wearing their seat belts properly and sitting correctly.

**What you should do:** Always wear your seat belt properly and sit upright and as far back from the steering wheel as possible while allowing full control of the vehicle. A front passenger should move their seat as far back from the dashboard as possible.

Remember, however, that no safety system can prevent all injuries or deaths that can occur in a severe crash, even when seat belts are properly worn and the airbags deploy.

**Do not place hard or sharp objects between yourself and a front airbag.**

Carrying hard or sharp objects on your lap, or driving with a pipe or other sharp object in your mouth, can result in injuries if your front airbag inflates.

**Do not attach or place objects on the front, driver's knee and front passenger's knee airbag covers.**

Objects on the covers marked **SRS AIRBAG** could interfere with the proper operation of the airbags or be propelled inside the vehicle and hurt someone if the airbags inflate.

## ▣ Important Facts About Your Airbags

Do not attempt to deactivate your airbags. Together, airbags and seat belts provide the best protection.

When driving, keep hands and arms out of the deployment path of the front airbag by holding each side of the steering wheel. Do not cross an arm over the airbag cover.

## Types of Airbags

Your vehicle is equipped with five types of airbags:

- **Front airbags:** Airbags in front of the driver's and front passenger's seats.
- **Knee airbags:** Airbags under the steering column and under the glove box.
- **Centre airbag:** Airbag in the centre side of driver's seat-back.
- **Side airbags:** Airbags in the driver's, front passenger's, and rear outer passenger's seat-backs.
- **Side curtain airbags:** Airbags above the side windows.

Each is discussed in the following pages.

## Front Airbags (SRS)

The front SRS airbags inflate in a moderate-to-severe frontal collision to help to protect the head and chest of the driver and/or front passenger.

**SRS** (Supplemental Restraint System) indicates that the airbags are designed to supplement seat belts, not replace them. Seat belts are the occupant's primary restraint system.

### ■ Housing Locations

The front airbags are housed in the centre of the steering wheel for the driver, and in the dashboard for the front passenger. Both airbags are marked **SRS AIRBAG**.

### ✎ Types of Airbags

The airbags can inflate whenever the power mode is in ON.

After an airbag inflates in a crash, you may see a small amount of smoke. This is from the combustion process of the inflator material and is not harmful. People with respiratory problems may experience some temporary discomfort. If this occurs, get out of the vehicle as soon as it is safe to do so.

## ■ Operation

Front airbags are designed to inflate during moderate-to-severe frontal collisions. When the vehicle decelerates suddenly, the sensors send information to the control unit which signals one or both front airbags to inflate.

A frontal collision can be either head-on or angled between two vehicles, or when a vehicle crashes into a stationary object, such as a concrete wall.

## ■ How the Front Airbags Work

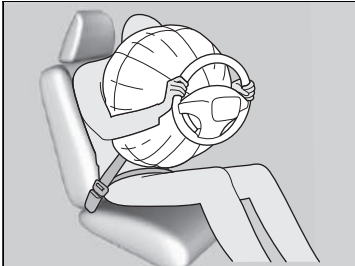

While your seat belt restrains your torso, the front airbag provides supplemental protection for your head and chest. The front airbags deflate immediately so that they won't interfere with the driver's visibility or the ability to steer or operate other controls.

The total time for inflation and deflation is so fast that most occupants are not aware that the airbags deployed until they see them lying in front of them.

### ■ When front airbags should not deploy

**Minor frontal crashes:** Front airbags were designed to supplement seat belts and help to save lives, not to prevent minor scrapes, or even broken bones that might occur during a less than moderate-to-severe frontal crash.

**Side impacts:** Front airbags can provide protection when a sudden deceleration causes a driver or front passenger to move towards the front of the vehicle. Side airbags and side curtain airbags have been specifically designed to help to reduce the severity of injuries that can occur during a moderate-to-severe side impact which can cause the driver or passenger to move towards the side of the vehicle.

**Rear impacts:** Head restraints and seat belts are your best protection during a rear impact. Front airbags cannot provide any significant protection and are not designed to deploy in such collisions.

**Rollovers:** Seat belts and side curtain airbags offer the best protection in a rollover. Because front airbags could provide little if any protection, they are not designed to deploy during a rollover.

### ■ When front airbags deploy with little or no visible damage

Because the airbag system senses sudden deceleration, a strong impact to the vehicle framework or suspension might cause one or more of the airbags to deploy. Examples include running into a curb, the edge of a hole, or other low fixed object that causes a sudden deceleration in the vehicle chassis. Since the impact is underneath the vehicle, damage may not be readily apparent.

### ■ When front airbags may not deploy, even though exterior damage appears severe

Since crushable body parts absorb crash energy during an impact, the amount of visible damage does not always indicate proper airbag operation. In fact, some collisions can result in severe damage but no airbag deployment because the airbags would not have been needed or would not have provided protection even if they had deployed.

## Passenger Front Airbag Off System

If it is unavoidable to install a rear-facing child restraint system in the front passenger seat, you must manually deactivate the passenger front airbag system, using the built-in key.

### Passenger front airbag ON/OFF switch

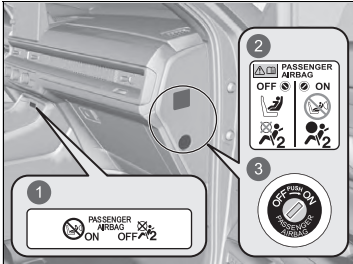

- 1 Passenger Front Airbag **ON/OFF** Indicator
- 2 System Warning Label
- 3 **ON/OFF** Switch

When the passenger front airbag **ON/OFF** switch is in:

**OFF:** The passenger front airbag is deactivated. The passenger front airbag does not inflate during a frontal crash that inflates driver's front airbag.

The passenger front airbag off indicator stays on as a reminder.

**ON:** The passenger front airbag is activated. The passenger front airbag on indicator comes on and remains on for about 60 seconds.

### Passenger Front Airbag Off System

#### ⚠ WARNING

The passenger front airbag system must be turned off, if it is not avoidable to put a rear-facing child restraint system in the front passenger seat.

If the front passenger airbag inflates, it can hit the rear-facing child restraint system with enough force to kill or cause a very serious injury to the infant.

#### ⚠ WARNING

Make sure to turn on the passenger front airbag system when a rear-facing child restraint system is not used on the front passenger seat.

Leaving the passenger front airbag system deactivated can result in serious injury or death in a crash.

### ■ To deactivate the passenger front airbag system



① Passenger Front Airbag **ON/OFF** Switch

1. Set the parking brake, and set the power mode to **VEHICLE OFF**.
2. Open the front passenger's door.
3. Insert the built-in key to the passenger front airbag **ON/OFF** switch.
  - ▶ The switch is located at the side panel of the front passenger side instrument panel.
4. Turn the built-in key to **OFF**, and remove it from the switch.

### ■ Passenger front airbag off indicator

When the passenger front airbag system is activated, the indicator goes off after a few seconds when you set the power mode to **ON**.

When the passenger front airbag system is deactivated, the indicator stays on, or goes off momentarily and comes back on.

### ▶▶ To deactivate the passenger front airbag system

#### NOTICE

- Use your vehicle's built-in key to turn the passenger front airbag **ON/OFF** switch. If you use a different key, the switch can be damaged, or the passenger front airbag system may not work properly.
- Do not close the door or apply an excessive load on the built-in key while the key is in the passenger front airbag **ON/OFF** switch. The switch or the key can be damaged.

We strongly recommend that you do not install a rear-facing child restraint system in the front passenger seat.

#### ▶▶ Protecting Infants P. 88

It is your responsibility to change the setting of the passenger front airbag system to **OFF** when you put a rear-facing child restraint system on the front passenger seat.

When a rear-facing child restraint system is not in use in the front passenger seat, turn the system back on.

### ■ Passenger front airbag off system label

The label is located at the side panel of the front passenger side instrument panel.



- ① Infant in a rear-facing child restraint system: May ride in front if it is unavoidable
- ② Cannot be seated in front
- ③ Passenger front airbag is: Active
- ④ Inactive

## Knee Airbags

The knee SRS airbags inflate in a moderate-to-severe frontal collision to help to keep the driver and/or front passenger in the proper position and to help to maximise the benefit provided by the vehicle's other safety features.

**SRS** (Supplemental Restraint System) indicates that the airbag is designed to supplement seat belts, not replace them. Seat belts are the occupant's primary restraint system.

### Housing Locations

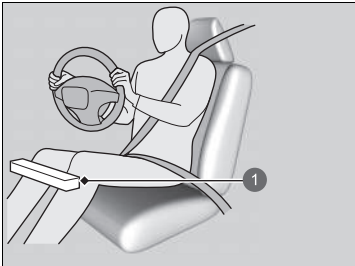

① Driver's Knee Airbag Location

The knee airbag for the driver and the one for the front passenger are housed under the steering column and the glove box respectively.

Both are marked **SRS AIRBAG**.

### ⚠ Knee Airbags

Do not attach accessories on or near a knee airbag as they can interfere with the proper operation of the airbag, or even hurt someone if the airbag inflates.

The driver and front passenger should not store any items under the seat or behind their feet. The items can interfere with proper airbag deployment in the event of a moderate to severe frontal collision and may result in inadequate protection.

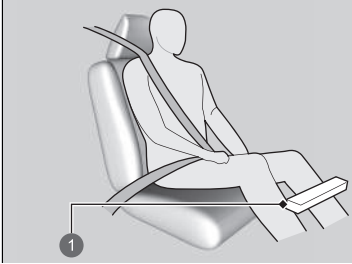

① Passenger's Knee Airbag Location

## ■ Operation

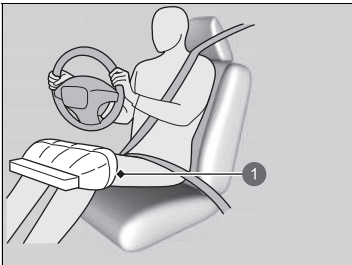

① Deployed Driver's Knee Airbag

The driver's and front passenger's knee airbag deploy at the same time as the driver's and front passenger's airbag respectively.

Even if the collision is not severe enough to deploy the front airbag, the knee airbag may inflate alone.

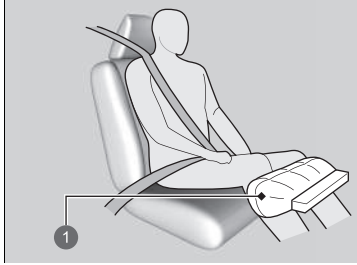

① Deployed Passenger's Knee Airbag

**■ When knee airbags deploy with little or no visible damage**

Because the airbag system senses sudden deceleration, a strong impact to the vehicle framework or suspension might cause one or more of the airbags to deploy. Examples include running into a curb, the edge of a hole, or other low fixed objects that cause a sudden deceleration in the vehicle chassis. Since the impact is underneath the vehicle, damage may not be readily apparent.

**■ When knee airbags may not deploy, even though exterior damage appears severe**

Since crushable body parts absorb crash energy during an impact, the amount of visible damage does not always indicate proper airbag operation. In fact, some collisions can result in severe damage but no airbag deployment because the airbags would not have been needed or would not have provided protection even if they had deployed.

## Centre Airbag

The centre airbag is designed to help to protect the heads of the driver and front passenger during a moderate-to-severe side impact.

### Housing Location

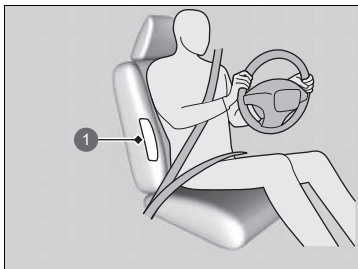

① Centre Airbag Location

The centre airbag is housed in the centre side of the driver's seat-back.

It is marked **CENTER AIRBAG**.

### Operation

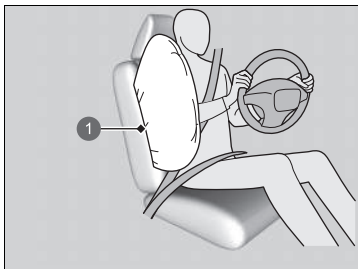

① Centre Airbag

When the sensors detect a moderate-to-severe side impact, the control unit signals the centre airbag to deploy.

### Centre Airbag

Make sure you and any front seat passenger always sit upright. Leaning into the path of the centre airbag can prevent the airbag from deploying properly and increases your risk of serious injury.

Do not attach accessories on or near the centre airbag. They can interfere with the proper operation of the airbag, or hurt someone if an airbag inflates.

Do not open the lid of the console compartment while driving.

Do not cover or replace the driver's seat-back cover without consulting a dealer. Improperly replacing or covering driver's seat-back covers can prevent your centre airbag from properly deploying during a side impact.

**■ When the centre airbag deploy with little or no visible damage**

Because the airbag system senses sudden acceleration, a strong impact to the side of the vehicle's framework can cause the centre airbag to deploy. In such cases, there may be little or no damage, but the side impact sensors detected a severe enough impact to deploy the airbag.

**■ When the centre airbag may not deploy, even though visible damage appears severe**

It is possible for the centre airbag to not deploy during an impact that results in apparently severe damage. This can occur when the point of impact was towards the far front or rear of the vehicle, or when the vehicle's crushable body parts absorbed most of the crash energy. In either case, the centre airbag would not have been needed nor provided protection even if it had deployed.

## Side Airbags

The side airbags help to protect the torso and pelvis of the driver, front passenger, or an outer rear seat occupant during a moderate-to-severe side impact.

### ■ Housing Locations

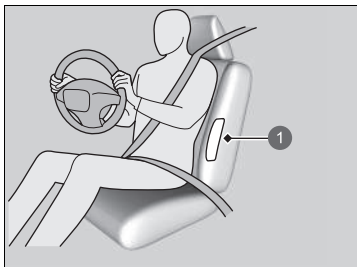

① Side Airbag Location

The side airbags are housed in the outside edge of the driver's, passenger's, and rear outer passenger's seat-backs.

Each are marked **SIDE AIRBAG**.



① Side Airbag Location

### ⌘ Side Airbags

Do not attach accessories on or near the side airbags. They can interfere with the proper operation of the airbags, or hurt someone if an airbag inflates.

## ■ Operation

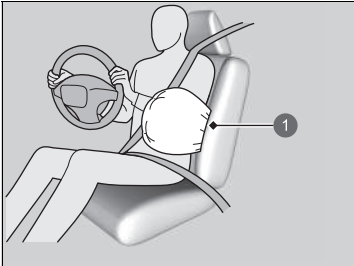

① Deployed Side Airbag

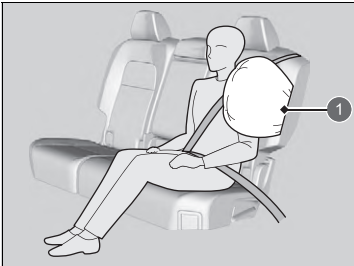

① Deployed Side Airbag

When the sensors detect a moderate-to-severe side impact, the control unit signals the side airbag on the impact side to immediately inflate.

### ■ When a side airbag deploys with little or no visible damage

Because the airbag system senses sudden acceleration, a strong impact to the side of the vehicle's framework can cause a side airbag to deploy. In such cases, there may be little or no damage, but the side impact sensors detected a severe enough impact to deploy the airbag.

## ⊠ Side Airbags

Do not cover or replace the seat-back covers without consulting a dealer. Improperly replacing or covering seat-back covers can prevent your side airbags from properly deploying during a side impact.

Do not let the front passenger lean sideways with their head in the deployment path of the side airbag. An inflating side airbag can strike with strong force and seriously injure the passenger.

Side airbag deployment is controlled by a pressure sensor inside each front door. Damage or changes to the inside or outside of the doors may negatively affect side airbag deployment. Contact an authorized dealer before changing or repairing a front door.

■ **When a side airbag may not deploy, even though visible damage appears severe**

It is possible for a side airbag not to deploy during an impact that results in apparently severe damage. This can occur when the point of impact was towards the far front or rear of the vehicle, or when the vehicle's crushable body parts absorbed most of the crash energy. In either case, the side airbag would not have been needed nor provided protection even if it had deployed.

## Side Curtain Airbags

The side curtain airbags help to protect the heads of the driver and passengers in outer seating positions during a moderate-to-severe side impact.

### ■ Housing Locations

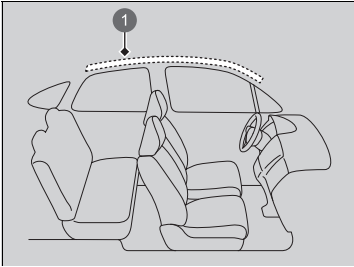

① Side Curtain Airbag Location

The side curtain airbags are located in the ceiling above the side windows on both sides of the vehicle.

### ▣ Side Curtain Airbags

The side curtain airbags are most effective when an occupant is wearing their seat belt properly and sitting upright, well back in their seat.

Do not attach any objects to the side windows or roof pillars as they can interfere with the proper operation of the side curtain airbags.

Do not put a coat hanger or hard objects on a coat hook. This could result in injuries if your side curtain airbag inflates.

## ■ Operation

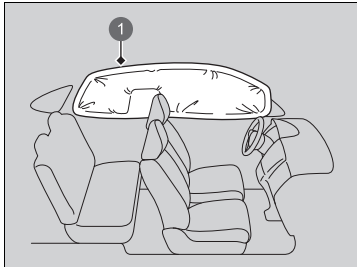

The side curtain airbag is designed to deploy in a moderate-to-severe side impact.

① Deployed Side Curtain Airbag

### ■ When side curtain airbags deploy in a frontal collision

One or both side curtain airbags may also inflate in a moderate-to-severe angled frontal collision.

## Airbag System Indicators

If a problem occurs in the airbag system, the SRS indicator will come on and a message appears on the driver information interface.

### Supplemental Restraint System (SRS) Indicator



#### ■ When the power mode is set to ON

The indicator comes on for a few seconds, then goes off. This tells you the system is working properly.

If the indicator comes on at any other time, or does not come on at all, have the system checked by a dealer as soon as possible. If you don't, your airbags and seat belt tensioners may not work properly when they are needed.

### Supplemental Restraint System (SRS) Indicator

#### **⚠ WARNING**

Ignoring the SRS indicator can result in serious injury or death if the airbag systems or tensioners do not work properly.

Have your vehicle checked by a dealer as soon as possible if the SRS indicator alerts you to a possible problem.

#### **⚠ WARNING**

Remove the rear-facing child restraint system immediately from the front passenger seat if the SRS indicator comes on. Even if the passenger front airbag has been deactivated, do not ignore the SRS indicator.

The SRS system may have a fault which could cause the passenger front airbag to be activated, causing serious injury or death.

*Continued*

## ■ Passenger Front Airbag Off Indicator

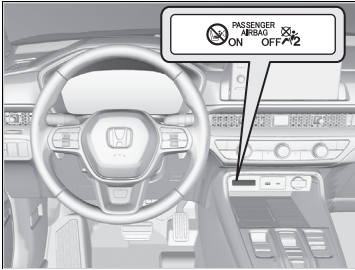

### ■ When the passenger airbag off indicator comes on

The indicator stays on while the passenger's front airbag system is deactivated.

When a rear-facing child restraint system is not in use in the front passenger seat, manually turn the system back on. The indicator should go off.

## Airbag Care

You do not need to, and should not, perform any maintenance on or replace any airbag system components yourself. However, you should have your vehicle inspected by a dealer in the following situations:

### ■ When the airbags have deployed

If an airbag has inflated, the control unit and other related parts must be replaced. Similarly, once an automatic seat belt tensioner has been activated, it must be replaced.

### ■ When the vehicle has been in a moderate-to-severe collision

Even if the airbags did not inflate, have your dealer inspect the following: the seat belt tensioners for the front seats and outer rear seats, and each seat belt that was worn during the crash.

#### ✘ Airbag Care

The removal of airbag components from the vehicle is prohibited.

In case of malfunction, or shutdown, or after the airbag inflation/seat belt tensioner operation, ask a qualified personnel for handling.

We recommend against the use of salvaged airbag system components, including the airbag, tensioners, sensors, and control unit.

## About Post-Collision Braking System

When the airbag system is activated after a collision is detected, this system simultaneously applies the brakes and limits propulsion to reduce damage from a secondary collision.

### ■ Conditions for activation

The Post-Collision Braking System activates when the airbag system or automatic seat belt tensioners activate due to a frontal collision or side impact.

However, it will not activate if components of the system are damaged.

### ■ Conditions for cancellation

After the Post-Collision Braking System is activated, the system will be cancelled if either of the following conditions are met.

- The vehicle is stopped.
- You depress the accelerator pedal after releasing it.

### ⌘ Post-Collision Braking System

This system may not be able to reduce damage from secondary collisions in all situations. Its effectiveness depends on the circumstances of the collision.

When a collision occurs, confirm your surroundings, and carefully operate your vehicle as needed to park in a safe place.

## Protecting Child Passengers

Each year, many children are injured or killed in vehicle crashes because they are either unrestrained or not properly restrained. In fact, vehicle crashes are the number one cause of death of children aged 12 and under.

To reduce the number of child deaths and injuries, infants and children should be properly restrained when they ride in a vehicle.

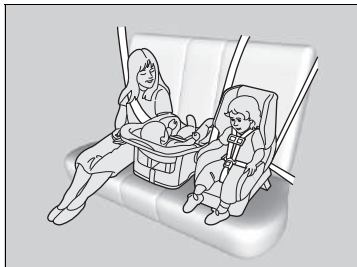

Children should sit properly restrained in a rear seat. This is because:

- An inflating front airbag can injure or kill a child sitting in the front seat.
- A child in the front seat is more likely to interfere with the driver's ability to safely control the vehicle.
- Statistics show that children of all sizes and ages are safer when they are properly restrained in a rear seat.

### Protecting Child Passengers

#### Front Passenger's Sun Visor

## ⚠ WARNING



**NEVER** use a rearward facing child restraint on a seat protected by an **ACTIVE AIRBAG** in front of it, **DEATH** or **SERIOUS INJURY** to the **CHILD** can occur.

## ⚠ WARNING

Children who are unrestrained or improperly restrained can be seriously injured or killed in a crash.

Any child too small for a seat belt should be properly restrained in an approved child restraint system. A larger child should be properly restrained with a seat belt, using a booster seat if necessary.

- Never hold a child on your lap because it is impossible to protect them in the event of a collision.
- Never put a seat belt over yourself and a child. During a crash, the belt would likely press deep into the child and cause serious or fatal injuries.
- Never let two children use the same seat belt. Both children could be very seriously injured in a crash.
- Any child who is too small to wear a seat belt must be properly restrained in an approved child restraint system that is properly secured to the vehicle using the seat belt or the child restraint anchorage system.

#### ► Protecting Child Passengers

In many countries, the law requires all children aged 12 and under, and whose height are shorter than 150 cm (60 inches) be properly restrained in a rear seat.

In many countries, it is required to use an officially approved and suitable child restraint system for transporting a child on any passenger seat. Check your local legal requirement.

We recommend a child restraint system compliant with UN Regulation No. 44 or No. 129, or the regulations of the subject countries.

► **Selecting a Child Restraint System** P. 91

- Do not allow children to operate the doors, windows, or seat adjustments.
- Do not leave children in the vehicle unattended, especially in hot weather when the inside of the vehicle can get hot enough to kill them. They could also activate vehicle controls causing it to move unexpectedly.

#### ▶▶ Protecting Child Passengers

**WARNING:** Use the power window lock button to prevent children from opening the windows. Using this feature will prevent children from playing with the windows, which could expose them to hazards or distract the driver.

#### ▶ Opening/Closing the Power Windows

P. 220

**WARNING:** Always take the ignition key with you whenever you leave the vehicle alone or with other occupants.

To remind you of the passenger's front airbag hazard and child safety, your vehicle has the warning label on the passenger's side sun visor.

Please read and follow the instructions on this label.

#### ▶ Safety Labels P. 114

## Safety of Infants and Small Children

### ■ Protecting Infants

An infant must be properly restrained in a rear-facing child restraint system until the infant reaches the child restraint system manufacturer's weight or height limit for the seat.



### ■ Positioning a rear-facing child restraint system

Child restraint system must be placed and secured in a rear seating position.

- ▶ We recommend that you install the child restraint system directly behind the front passenger's seat, move the seat as far forward as needed, and leave it unoccupied.
- ▶ Make sure that there is no contact between the child restraint system and the seat in front of it. If there is, you may wish to get a smaller rear-facing child restraint system.

### ▶▶ Protecting Infants

## ⚠ WARNING

Placing a rear-facing child restraint system in the front seat can result in serious injury or death if the passenger's front airbag inflates.

Always place a rear-facing child restraint system in the back seat, not the front.

When properly installed, a rear-facing child restraint system may prevent the driver or a front passenger from moving their seat all the way back, or from locking their seat-back in the desired position.

#### ☒ Protecting Infants

Many experts recommend use of a rear-facing child restraint system for a child up to two years old if the child's height and weight are appropriate for a rear-facing child restraint system.

Rear-facing child restraint systems should never be installed in a front-facing position.

Always refer to the child restraint system manufacturer's instructions before installation.

If the passenger's front airbag inflates, it can hit the rear-facing child restraint system with great force, which can dislodge or strike the system, and seriously injure the child.

If it is absolutely unavoidable to install a rear-facing child restraint system in the front passenger seat, manually turn off the passenger front airbag system.

☒ **Passenger Front Airbag Off System** P. 67

## ■ Protecting Smaller Children

If a child has exceeded the weight and height limitations of a rear-facing child restraint system, the child should be properly restrained in a firmly secured front-facing child restraint system until they exceed the weight and height limitations for the front-facing child restraint system.



### ■ Front-facing child restraint system placement

We strongly recommend placing a front-facing child restraint system in a rear seating position.

Placing a front-facing child restraint system in the front seat can be hazardous. A rear seat is the safest place for a child.

## ▶▶ Protecting Smaller Children

### **⚠ WARNING**

**Placing a front-facing child restraint system in the front seat can result in serious injury or death if the front airbag inflates.**

**If you must place a front-facing child restraint system in front, move the vehicle seat as far back as possible, and properly restrain the child.**

Educate yourself about the laws and regulations regarding child restraint system use where you are driving, and follow the child restraint system manufacturer's instructions.

## ■ Selecting a Child Restraint System

Some child restraint systems are lower anchorage compatible. Some have a rigid-type connector while others have a flexible-type connector. Both are equally easy to use. Some existing and previously owned child restraint systems can only be installed using the seat belt. Whichever type you choose, follow the child restraint system manufacturer's use and care instructions including recommended expiration dates as well as the instructions in this manual. Proper installation is key to maximising your child's safety.

The flexible type may not be available in your country.

In seating positions and vehicles not equipped with lower anchorages, install a child restraint system using the seat belt and a top tether for added security. This is because all child restraint systems must be secured with the seat belt when the lower anchorage system is not in use. In addition, the child restraint system manufacturer may advise that a seat belt be used to attach an ISOFIX restraint system once a child reaches a specified weight. Please read the child restraint system owner's manual for proper installation instructions.

### ■ Important consideration when selecting a child restraint system

Make sure the child restraint system meets the following three requirements:

- The child restraint system is the correct type and size for the child.
- The child restraint system is the correct type for the seating position.
- The child restraint system is compliant with safety standards. We recommend a child restraint system compliant with UN Regulation No. 44 or No. 129, or the regulations of the subject countries. Look for the approval mark on the system and the manufacturer's statement of compliance on the box.

### ☒ Selecting a Child Restraint System

Installation of a lower anchorage-compatible child restraint system is simple.

Lower anchorage-compatible child restraint systems have been developed to simplify the installation process and reduce the likelihood of injuries caused by incorrect installation.

*Continued*

## ■ Child Restraint Systems Standards

If a child restraint system (whether an i-Size/ISOFIX type or one that is fitted with a seat belt) meets the relevant UN Regulation, it will be affixed with an approval label as shown in the adjacent table. Before purchasing or using any child restraint system, make sure to check the approval label and ensure that it is compatible with your vehicle and the child, and that it complies with the relevant UN Regulation.

### ▶▶ Selecting a Child Restraint System

Example of UN Regulation No. 44 approval label

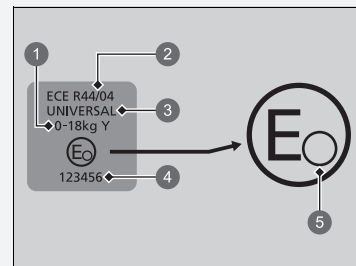

- ① “Mass group”
- ② Regulation number
- ③ Category
- ④ Approval number
- ⑤ Country code

▶▶ Selecting a Child Restraint System

Example of UN Regulation No. 129 approval label

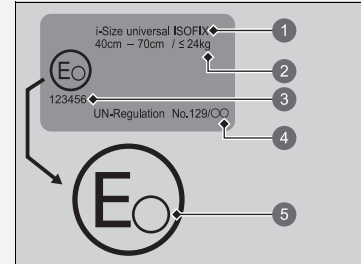

- ① Category
- ② Size and weight indication
- ③ Approval number
- ④ Regulation number
- ⑤ Country code

Continued

## Locations for Child Restraint System Installation

Left-hand Drive Type

Passenger Airbag ON

Passenger Airbag OFF

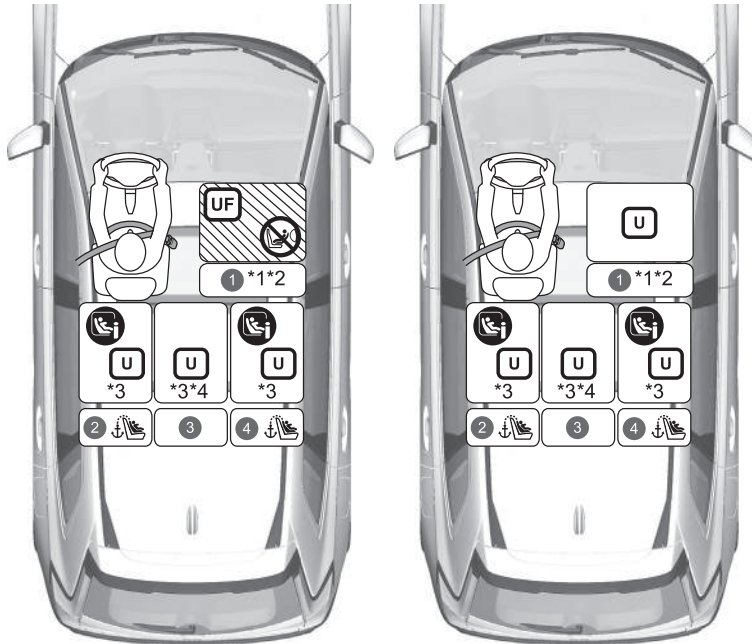

	Suitable for universal restraint systems installed with vehicle safety belts.
	Suitable for forward facing universal restraint systems installed with vehicle safety belts.
	Suitable for i-Size and ISOFIX child restraints systems.
	Suitable for forward facing restraint systems only.
	Never use a rearward facing child restraint system.
	Seat position equipped with Top Tether anchorages.

- \*1: Adjust the seat slide to the most rear position.
- \*2: For installing the universal belted type, adjust the seat back to the most front lock position.
- \*3: Adjust the 2nd row seat slide to the rearmost position.
- \*4: If you attach a child restraint system to the rear centre seat may make the left side seat belt unusable.
- If the child restraint system interferes with the head restraint and cannot be installed stably, raise the head restraint. Remove the head restraint if it is removable. If interference can be avoided by raising the head restraint, then it is not necessary to remove it. Please note that the removed head restraint should be stored in the luggage compartment so that it will not fly during sudden braking or collision.  
Also, if you remove the child restraint system, attach the head restraint to the original seat and make sure it is locked.  
However, when using the booster cushion only, do not remove the head restraint.
- If you cannot fix the forward facing child restraint system stably, adjust the seat-back angle to be parallel with the back still keeping it forward of the seat belt shoulder anchorage.
- Child restraint systems with support leg can be installed in seating position where i-Size cannot be installed.

Right-hand Drive Type

Passenger Airbag ON

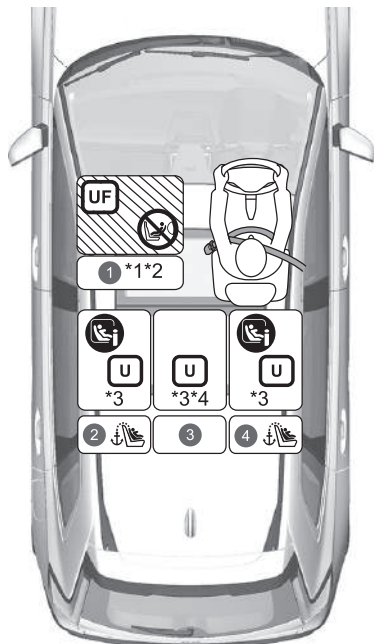

Passenger Airbag OFF

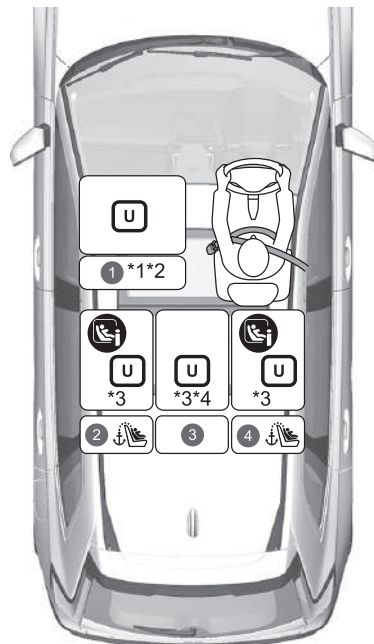

	Suitable for universal restraint systems installed with vehicle safety belts.
	Suitable for forward facing universal restraint systems installed with vehicle safety belts.
	Suitable for i-Size and ISOFIX child restraints systems.
	Suitable for forward facing restraint systems only.
	Never use a rearward facing child restraint system.
	Seat position equipped with Top Tether anchorages.

- \*1: Adjust the seat slide to the most rear position.
- \*2: For installing the universal belted type, adjust the seat back to the most front lock position.
- \*3: Adjust the 2nd row seat slide to the rearmost position.
- \*4: If you attach a child restraint system to the rear centre seat may make the left side seat belt unusable.
- If the child restraint system interferes with the head restraint and cannot be installed stably, raise the head restraint. Remove the head restraint if it is removable. If interference can be avoided by raising the head restraint, then it is not necessary to remove it. Please note that the removed head restraint should be stored in the luggage compartment so that it will not fly during sudden braking or collision.  
Also, if you remove the child restraint system, attach the head restraint to the original seat and make sure it is locked.  
However, when using the booster cushion only, do not remove the head restraint.
- If you cannot fix the forward facing child restraint system stably, adjust the seat-back angle to be parallel with the back still keeping it forward of the seat belt shoulder anchorage.
- Child restraint systems with support leg can be installed in seating position where i-Size cannot be installed.

All models

Detail information for CRS installation

	Seating position and Seat position number						
	Size groups Weight Stature		①		②	③	④
			Front passenger*1		2nd row*3		
			Front passenger airbag ON/OFF switch position		Left	Centre *4	Right
ON*5	OFF						
Seating position suitable for universal belted (yes/no)	Group 0	Up to 10kg	No	Yes*2	Yes	Yes	Yes
	Group 0+	Up to 13kg					
	Group I	9-18kg	Yes*2	Yes	Yes	Yes	
	Group II	15-25kg					
	Group III	22-36kg					
i-Size seating position (yes/no)	≤ 150cm		No	No	Yes	No	Yes
Seating position suitable for recommended genuine CRS*6	Refer to genuine CRS list		Yes	Yes	Yes	Yes	Yes
Seating position suitable for lateral fixture (L1/L2)	—		No	No	No	No	No
Largest suitable rearward facing fixture (R1/R2X/R2/R3)	Group 0	Up to 10kg	No	No	R3	No	R3
	Group 0+	Up to 13kg					
	Group I	9-18kg					
Largest suitable forward facing fixture (F2X/F2/F3)	Group I	9-18kg	No	No	F3	No	F3
Largest suitable booster fixture (B2/B3)	≤ 150cm		B3	B3	B3	B3	B3

▶▶ Locations for Child Restraint System Installation

When purchasing a child restraint systems, make sure to check the ISOFIX size class or the fixture to ensure that the seat is compatible with your vehicle.

Fixture (CRF)	Description
ISO/L1	Left lateral-facing (carrycot) infant seat
ISO/L2	Right lateral-facing (carrycot) infant seat
ISO/R1	Rearward-facing infant seat
ISO/R2X	Reduced-size rearward-facing child restraint systems
ISO/R2	Reduced-size rearward-facing child restraint systems
ISO/R3	Full-size rearward-facing child restraint systems
ISO/F2X	Reduced-height forward-facing child restraint systems
ISO/F2	Reduced-height forward-facing child restraint systems
ISO/F3	Full-height, forward-facing child restraint systems
ISO/B2	Reduced width forward-facing booster seat
ISO/B3	Full width forward-facing booster seat

- \*1: Adjust the seat slide to the most rear position.
- \*2: For installing the universal belted type, adjust the seat back to the most front lock position.
- \*3: Adjust the 2nd row seat slide to the rearmost position.
- \*4: If you attach a child restraint system to the rear centre seat may make the left side seat belt unusable.
- \*5: Only forward facing child restraint system can be installed when the front passenger airbag is on.
- \*6: The named Child Restraint Systems (CRS) reflect Honda's recommendations at the date of publication. You should speak to an authorised dealer for up to date details relating to our recommended CRSs. Other CRS may also be suitable - please consult CRS manufacturers for recommended vehicle lists.
  - If the child restraint system interferes with the head restraint and cannot be installed stably, raise the head restraint. Remove the head restraint if it is removable. If interference can be avoided by raising the head restraint, then it is not necessary to remove it. Please note that the removed head restraint should be stored in the luggage compartment so that it will not fly during sudden braking or collision.

Also, if you remove the child restraint system, attach the head restraint to the original seat and make sure it is locked.

However, when using the booster cushion only, do not remove the head restraint.
  - If you cannot fix the forward facing child restraint system stably, adjust the seat-back angle to be parallel with the back still keeping it forward of the seat belt shoulder anchorage.
  - Child restraint systems with support leg can be installed in seating position where i-Size cannot be installed.

## ■ Europe Genuine CRS List

### UN R129

Range of application	Child Restraint System	Category
40cm to 83cm up to 13kg (Birth - 15 months)	Honda baby safe	Universal Belted
	Honda baby safe ISOFIX	i-Size universal ISOFIX
76cm to 105cm 9kg to 22kg (15 months - 4 years)	Honda ISOFIX	i-Size Universal ISOFIX
100cm to 150cm 15kg to 36kg (3.5 years - 12 years)	Honda KIDFIX *1	i-Size Booster seat

\*1: Move the shoulder anchorage to its highest position when the child restraint system is placed on the rear outboard seating position.

## ■ Installing a Lower Anchorage-Compatible Child Restraint System

A lower anchorage-compatible child restraint system can be installed in either of the two outer rear seats. A child restraint system is attached to the lower anchorages with either the rigid or flexible type of connectors (see illustrations).



1 Marks

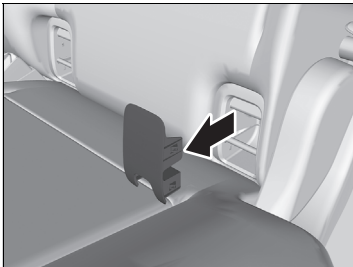

1. Locate the lower anchorages under the cover.
2. Move the seat to the most rear position.

3. Remove the anchorage covers with the marks to expose the lower anchorages.

## ⊠ Installing a Lower Anchorage-Compatible Child Restraint System

### ⚠ WARNING

Never attach two child restraint systems to the same anchorage. In a collision, one anchorage may not be strong enough to hold two child restraint system attachments and may break, causing serious injury or death.

Some child restraint systems come with optional guide-cups, which avoid possible damage to the seat surface. Follow the manufacturer's instructions when using the guide-cups, and attach them to the lower anchorages as shown in the image.

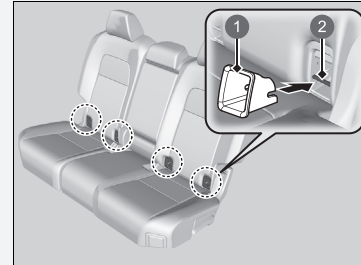

- 1 Guide-cup
- 2 Lower Anchorage

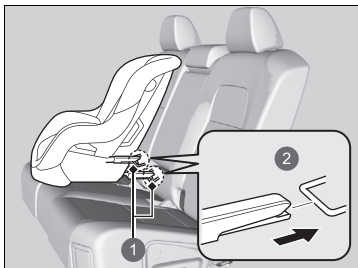

- ① Lower Anchorages
- ② Rigid Type

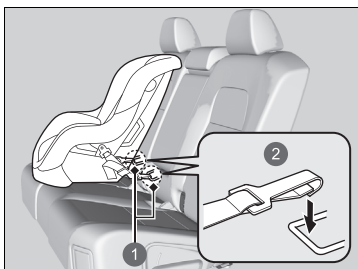

- ① Lower Anchorages
- ② Flexible Type

4. Place the child restraint system on the vehicle seat, then attach the child restraint system to the lower anchorages according to the instructions that came with the child restraint system.

- When installing the child restraint system, make sure that the lower anchorages are not obstructed by the seat belt or any other object.
- Install the child restraint system so that the gap between it and the seat back is as small as possible.

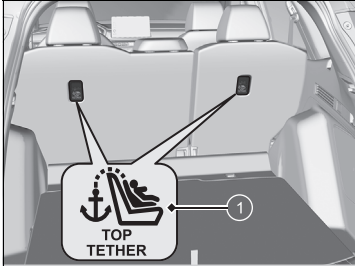

1 Top Tether Anchorage Symbol

► Installing a Lower Anchorage-Compatible Child Restraint System

**WARNING:** Never use a hook that does not come with a Top Tether Anchorage Symbol when securing an installed child restraint system.

For your child's safety, when using a child restraint system installed using the lower anchorage system, make sure that the child restraint system is properly secured to the vehicle.

A child restraint system that is not properly secured will not adequately protect a child in a crash and may cause injury to the child or other vehicle occupants.

The flexible type may not be available in your country.

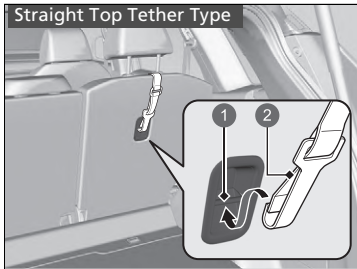

- 1 Anchorage
- 2 Tether Strap Hook

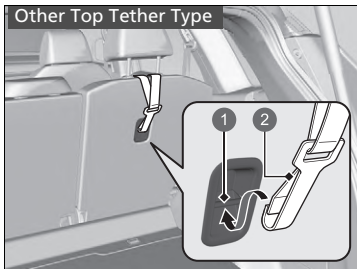

- 1 Anchorage
- 2 Tether Strap Hook

**Child restraint system with tether strap**

- 5. Raise the head restraint to its highest position.
  - Retract the luggage area cover.
    - ▣ **Luggage Area Cover** P. 274
- 6. Route the tether strap through the head restraint legs.  
Make sure the strap is not twisted.
- 7. Secure the tether strap hook to the anchorage.
- 8. Tighten the tether strap as instructed by the child restraint system manufacturer.
- 9. Make sure the child restraint system is firmly secured by rocking it forward and back, and side to side; little movement should be felt.
- 10. Make sure any unused seat belt that a child can reach is buckled.

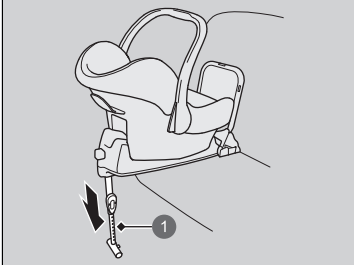

1 Support Leg

#### Child restraint system with support leg

5. Extend the support leg until it touches the floor as instructed by the child restraint system manufacturer.
  - ▶ Confirm that the section of the floor on which the support leg rests is level. If the section is not level, the support leg will not provide adequate support. If this is the case, move the seat forward or back so that the support leg is resting on a level section.
  - ▶ Make sure that the support leg is not resting on the slide rail or cover.
  - ▶ Make sure that there is no contact between the child restraint system and the seat in front of it.
6. Make sure the child restraint system is firmly secured by rocking it forward and back, and side to side; little movement should be felt.

## ■ Installing a Child Restraint System with a Lap/Shoulder Seat Belt

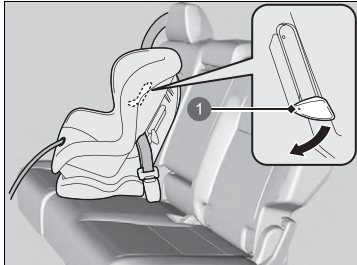

1 Tab

1. Move the seat to the most rear position.
2. Place the child restraint system on the vehicle seat.
3. Route the seat belt through the child restraint system according to the child restraint system manufacturer's instructions, and insert the latch plate into the buckle.
  - Insert the latch plate fully until it clicks.
4. Push down the tab. Route the shoulder part of the belt into the slit at the side of the restraint.
5. Grab the shoulder part of the belt near the buckle, and pull up to remove any slack from the lap part of the belt.
  - When doing this, place your weight on the child restraint system and push it into the vehicle seat.
6. Position the belt properly and push up the tab. Make sure the belt is not twisted.
  - When pushing up the tab, pull up the upper shoulder part of the belt to remove any slack from the belt.

## ▣ Installing a Child Restraint System with a Lap/Shoulder Seat Belt

A child restraint system that is not properly secured will not adequately protect a child in a crash and may cause injury to the child or other vehicle occupants.

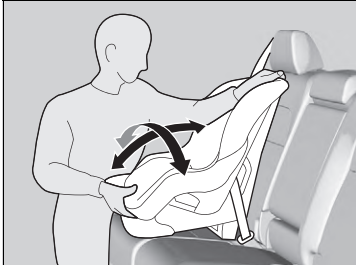

7. Make sure the child restraint system is firmly secured by rocking it forward and back, and side to side; little movement should be felt.
8. Make sure any unused seat belt that a child can reach is buckled.

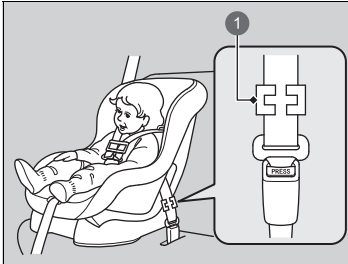

1 Locking Clip

**Except European models**

If your child restraint system does not come with a mechanism that secures the belt, install a locking clip on the seat belt.

After going through the step 1 - 3, pull up the shoulder part of the belt and make sure there is no slack in the lap portion.

4. Tightly grasp the belt near the latch plate. Pinch both parts of the belt together so they do not slip through the latch plate. Unbuckle the seat belt.
5. Install the locking clip as shown in the image. Position the clip as close as possible to the latch plate.
6. Insert the latch plate into the buckle. Go to step 7 and 8.

## ■ Adding Security with a Tether

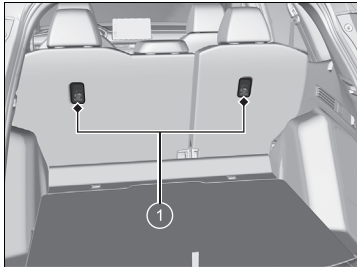

① Tether Anchorage Points

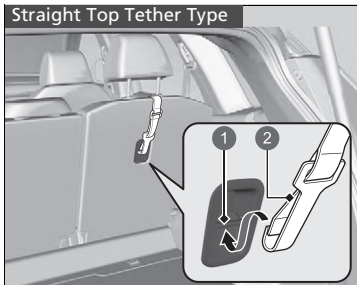

① Anchorage  
② Tether Strap Hook

A tether anchorage point is provided behind each rear outer seating position. If you have a child restraint system that comes with a tether but can be installed with a seat belt, the tether may be used for additional security.

1. Raise the head restraint to its highest position.
  - ▶ Retract the luggage area cover.
    - ▶ **Luggage Area Cover** P. 274
2. Route the tether strap through the head restraint legs. Make sure the strap is not twisted.
3. Secure the tether strap hook to the anchorage.
4. Tighten the tether strap as instructed by the child restraint system manufacturer.

## ▶▶ Adding Security with a Tether

**WARNING:** Child restraint anchorages are designed to withstand only those loads imposed by correctly fitted child restraints. Under no circumstances are they to be used for adult seat belts, harnesses or for attaching other items or equipment to the vehicle.

Always use a tether for front-facing child restraint system whether using the seat belt or lower anchorages.

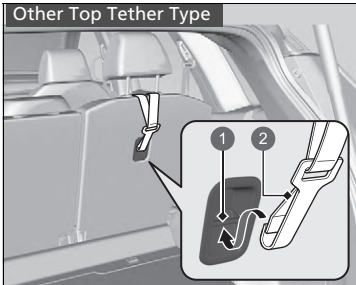

- ① Anchorage
- ② Tether Strap Hook

## Safety of Larger Children

### ■ Protecting Larger Children

The following pages give instructions on how to check proper seat belt fit, what kind of booster seat to use if one is needed, and important precautions for a child who must sit in front.

### ■ Checking Seat Belt Fit

When a child is too big for a child restraint system, secure the child in a rear seat using the lap/shoulder seat belt. Have the child sit upright and all the way back, then answer the following questions.



#### ■ Checklist

- Do the child's knees bend comfortably over the edge of the seat?
- Does the shoulder belt cross between the child's neck and arm?
- Is the lap part of the seat belt as low as possible, touching the child's thighs?
- Will the child be able to stay seated like this for the whole trip?

If you answer yes to all these questions, the child is ready to wear the lap/shoulder seat belt correctly. If you answer no to any question, the child needs to ride on a booster seat until the seat belt fits properly without a booster seat.

### ▶ Safety of Larger Children

## ⚠ WARNING

Allowing a child aged 12 or under to sit in front can result in injury or death if the passenger's front airbag inflates.

If a larger child must ride in front, move the vehicle seat as far to the rear as possible, have the child sit up properly and wear the seat belt properly, and use a booster seat if needed.

## Booster Seats



If a lap/shoulder seat belt cannot be used properly, position the child in a booster seat in the rear seat. For the child's safety, check that the child meets the booster seat manufacturer's recommendations.



A backrest is available for a specific booster seat. Install the backrest to the booster seat and adjust it to the vehicle seat according to the booster seat manufacturer's instructions. Make sure the seat belt is properly routed through the guide at the shoulder of the backrest and the belt does not touch and cross the child's neck.

1 Guide

### Booster Seats

When installing a booster seat, make sure to read the instructions that came with it, and install the seat accordingly.

There are high- and low-type booster seats. Choose a booster seat that allows the child to wear the seat belt correctly.

We recommend a booster seat with a backrest as it is easier to adjust the shoulder belt.

*Continued*

## ■ Protecting Larger Children - Final Checks

Your vehicle has a rear seat where children can be properly restrained. If you ever have to carry a group of children, and a child must ride in front:

- Make sure you read and fully understand the instructions and safety information in this manual.
- Move the front passenger seat as far back as possible.
- Have the child sit upright and well back in the seat.
- Check that the seat belt is properly positioned so that the child is secure in the seat.

### ■ Monitoring child passengers

We strongly recommend that you keep an eye on child passengers. Even older, more mature children sometimes need to be reminded to fasten their seat belts and sit up properly.

## Carbon Monoxide Gas

The engine exhaust from this vehicle contains carbon monoxide, a colourless, odourless, and highly toxic gas. As long as you properly maintain your vehicle, carbon monoxide gas will not get into the interior.

### ■ Have the exhaust system inspected for leaks whenever

- The exhaust system is making an unusual noise.
- The exhaust system may have been damaged.
- The vehicle is raised for an oil change.

When you operate a vehicle with the tailgate open, airflow can pull exhaust gas into the interior and create a hazardous condition. If you must drive with the tailgate open, open all the windows and set the climate control system as shown below.

1. Select the fresh air mode.
2. Select the  mode.
3. Set the fan speed to high.
4. Set the temperature control to a comfortable setting.

Adjust the climate control system in the same manner if you sit in your parked vehicle with the engine running.

### ☒ Carbon Monoxide Gas

## ⚠ WARNING

Carbon monoxide gas is toxic. Breathing it can cause unconsciousness and even kill you.

Avoid any enclosed areas or activities that expose you to carbon monoxide.

An enclosed area such as a garage can quickly fill up with carbon monoxide gas.

Do not run the engine with the garage door closed. Even when the garage door is open, drive out of the garage immediately after starting the engine.

## Label Locations

These labels are in the locations shown. They warn you of potential hazards that can cause serious injury or death. Read these labels carefully.

If a label comes off or becomes hard to read, contact a dealer for a replacement.

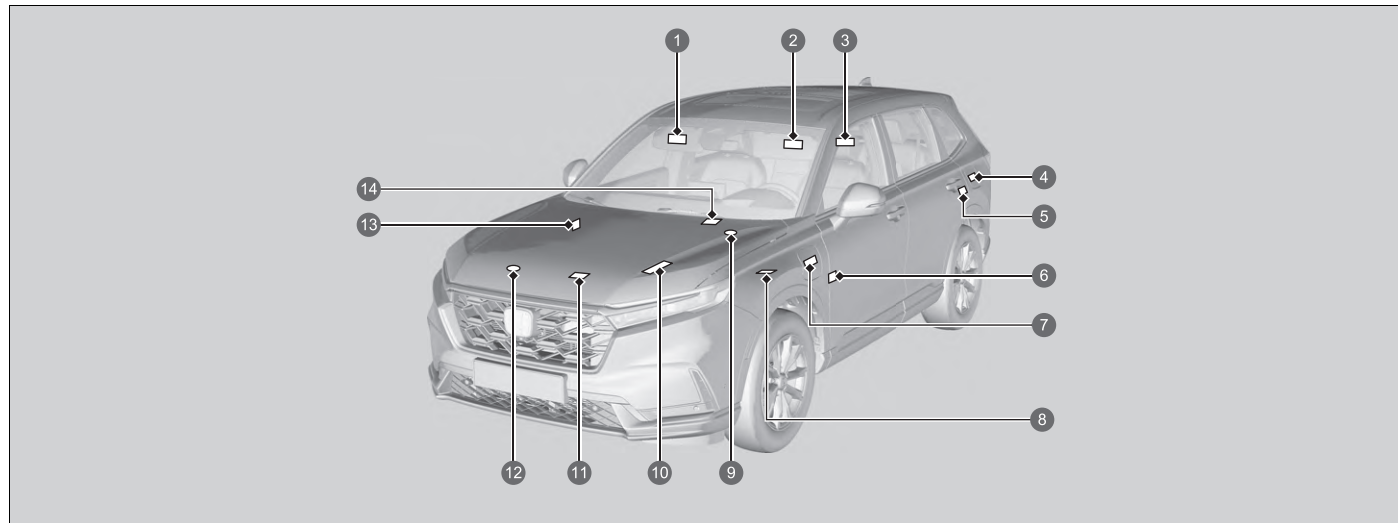

- 1 Protecting Child Passenger (Left-hand drive type) ➤ P. 85
- 2 Protecting Child Passenger (Right-hand drive type) ➤ P. 85
- 3 Rear Head Restraint ➤ P. 260
- 4 Fuel ➤ P. 651
- 5 Actuator Lid
- 6 Passenger Front Airbag Off System (Right-hand drive type) ➤ P. 69
- 7 Charging Lid
- 8 High Voltage Battery System
- 9 Inverter Coolant Reserve Tank Cap
- 10 12-volt battery ➤ P. 720
- 11 Air Conditioner ➤ P. 723
- 12 Radiator Cap ➤ P. 698
- 13 Passenger Front Airbag Off System (Left-hand drive type) ➤ P. 69
- 14 Wireless Charger ➤ P. 277

# Instrument Panel

This chapter describes the buttons, indicators, and gauges that are used while driving.



<b>Indicators</b> .....	116
Driver Information Interface Warning and Information Messages.....	138
<b>Gauges and Displays</b>	
Gauges.....	157
Driver Information Interface Left Side Area .....	161
Driver Information Interface Right Side Area .....	164
Head-Up Display* .....	179



























\* Not available on all models

Indicators come on/blink depending on the condition of the vehicle. Messages may display on the driver information interface at the same time. Please take the appropriate action outlined in the message, such as contacting a dealer.





























Display messages by setting **Warning message** to ON via the audio/information screen.

You can also change the message language.

 **Customized Features** P. 360

 *1	Parking Brake and Brake System Indicator (Red)	→ P. 118	 *1	Power System Indicator	→ P. 122	 *1	Vehicle Stability Assist (VSA) System Indicator	→ P. 124
 *1	Parking Brake and Brake System Indicator (Amber)	→ P. 120		Ready Indicator	→ P. 122	 OFF	Vehicle Stability Assist (VSA) OFF Indicator	→ P. 124
 *1	Automatic Brake Hold System Indicator	→ P. 120	 EV	EV Indicator	→ P. 122	 *1	Low Tyre Pressure/Deflation Warning System Indicator	→ P. 125
 *1	Automatic Brake Hold Indicator	→ P. 120		Seat Belt Reminder Indicator	→ P. 122		Turn Signal and Hazard Warning Indicators	→ P. 126
 *1	Malfunction Indicator Lamp	→ P. 121		Low Fuel Indicator	→ P. 123		Lights On Indicator	→ P. 126
 *1	12-Volt Battery Charging System Indicator	→ P. 121	 *1	Anti-lock Brake System (ABS) Indicator	→ P. 123		High Beam Indicator	→ P. 126
 *1	Shift Position Indicator	→ P. 121	 *1	Supplemental Restraint System Indicator	→ P. 123	 *1	Adaptive Driving Beam Indicator	→ P. 126
 *1	Transmission System Indicator	→ P. 121	 ON/OFF *1	Passenger Front Airbag On/Off Indicators	→ P. 123		Rear Fog Light Indicator	→ P. 126
 *1	Deceleration Paddle Selector Indicator	→ P. 122	 *1	Electric Power Steering (EPS) System Indicator	→ P. 124			







\*1: When you set the power mode to ON, these indicators come on to indicate that system checks are being performed. They go off a few seconds later or after the power system has started. If an indicator does not come on or turn off, there may be a malfunction in the corresponding system. To resolve the issue, follow the instructions in the owner's manual.





 ECON	ECON Mode Indicator	→ P. 128	 LIM	Adjustable Speed Limiter Indicator (White/Green)	→ P. 131	 *1	Collision Mitigation Braking System (CMBS) Indicator (Amber)	→ P. 133
 SPORT	SPORT Mode Indicator	→ P. 128	 I LIM	Intelligent Speed Limiter Indicator (White/Green)	→ P. 131		Collision Mitigation Braking System (CMBS) Indicator (Grey)	→ P. 133
 NORMAL	NORMAL Mode Indicator	→ P. 128	 ○	Immobilizer System Indicator	→ P. 127	 *1	Road Departure Mitigation Indicator (Amber)	→ P. 133
 SNOW	SNOW Mode Indicator	→ P. 128	 ○	Security System Alarm Indicator	→ P. 127		Road Departure Mitigation Indicator (Grey)	→ P. 133
 TOW	TOW Mode Indicator	→ P. 128	 *1	Adaptive Cruise Control (ACC) with Low Speed Follow Indicator (Amber)	→ P. 130		Road Departure Mitigation System Steering Assist Auto OFF indicator	→ P. 133
 AUTO	AUTO Mode Indicator	→ P. 129		Adaptive Cruise Control (ACC) with Low Speed Follow Indicator (White/Green)	→ P. 131	 *1	Safety Support Indicator (Amber)	→ P. 134
 EV	EV Mode Indicator	→ P. 129	 *1	Lane Keeping Assist System (LKAS) Indicator (Amber)	→ P. 132		Safety Support Indicator (Green/Grey)	→ P. 137
 SAVE	SAVE Mode Indicator	→ P. 129		Lane Keeping Assist System (LKAS) Indicator (White/Green)	→ P. 132	 *1	Driver Monitoring Camera Indicator (Amber)	→ P. 137
 CHARGE	CHARGE Mode Indicator	→ P. 129		Active Lane Change Assist Indicator (Amber)	→ P. 132		Driver Monitoring Camera Indicator (Grey)	→ P. 137
 *1	Hill Descent Control System Indicator (White/Green)	→ P. 129		Active Lane Change Assist Indicator (White/Green)	→ P. 132			
 i	System Message Indicator	→ P. 130						
 P	Parking Sensor Indicator	→ P. 130						
	Adaptive Cruise Control (ACC) with Low Speed Follow Interval Indicator	→ P. 131						





\*1: When you set the power mode to ON, these indicators come on to indicate that system checks are being performed. They go off a few seconds later or after the power system has started. If an indicator does not come on or turn off, there may be a malfunction in the corresponding system. To resolve the issue, follow the instructions in the owner's manual.





Indicator	Name	On/Blinking	Explanation
 (Red)	Parking Brake and Brake System Indicator (Red)	<ul style="list-style-type: none"> <li>• Comes on when the parking brake is applied, and goes off when it is released.</li> </ul>	<ul style="list-style-type: none"> <li>• The beeper sounds and the indicator comes on if you drive with the parking brake applied.</li> <li>• Comes on for about 30 seconds when you apply the electric parking brake while the power mode is in ACCESSORY or VEHICLE OFF, then goes off.</li> <li>• Stays on for about 30 seconds when you set the power mode to VEHICLE OFF while the electric parking brake is applied, then goes off.</li> </ul>
		<ul style="list-style-type: none"> <li>• Comes on when the brake fluid level is low.</li> </ul>	<ul style="list-style-type: none"> <li>• <b>Comes on while driving</b> - Make sure the parking brake is released. Stop in a safe place and check the brake fluid level.                             <ul style="list-style-type: none"> <li>➤ <b>What to do when the indicator comes on while driving</b> P. 759</li> </ul> </li> </ul>



Indicator	Name	On/Blinking	Explanation
 (Red)	Parking Brake and Brake System Indicator (Red)	<ul style="list-style-type: none"> <li>• Comes on if there is a problem with the brake system.</li> </ul>	<ul style="list-style-type: none"> <li>• <b>Comes on along with the Parking Brake and Brake System Indicator (amber)</b> - Immediately stop in a safe place. Contact a dealer for repair. The brake pedal becomes harder to operate. Depress the pedal further than you normally do.                             <ul style="list-style-type: none"> <li>▶ <b>If the Brake System Indicator (Red) Comes On or Blinks at the Same Time When the Brake System Indicator (Amber) Comes On</b> P. 761</li> </ul> </li> <li>• <b>Comes on along with the ABS indicator</b> - Have your vehicle checked by a dealer.                             <ul style="list-style-type: none"> <li>▶ <b>If the Brake System Indicator (Red) Comes On or Blinks</b> P. 759</li> </ul> </li> <li>• <b>Blinks and the Parking Brake and Brake System Indicator (amber) comes on at the same time</b> - There is a problem with the electric parking brake system. The parking brake may not be set. Avoid using the parking brake and have your vehicle checked by a dealer immediately.                             <ul style="list-style-type: none"> <li>▶ <b>If the Brake System Indicator (Red) Comes On or Blinks at the Same Time When the Brake System Indicator (Amber) Comes On</b> P. 761</li> </ul> </li> </ul>

Indicator	Name	On/Blinking	Explanation
 (Amber)	Parking Brake and Brake System Indicator (Amber)	<ul style="list-style-type: none"> <li>• Comes on if there is a problem with a system related to braking other than the conventional brake system.</li> </ul>	<ul style="list-style-type: none"> <li>• <b>Comes on while driving</b> - Avoid high speeds and sudden braking. Take the vehicle to a dealer immediately.</li> </ul>
		<ul style="list-style-type: none"> <li>• Comes on if there is a problem with the electric parking brake system and/or the automatic brake hold system.</li> </ul>	<ul style="list-style-type: none"> <li>• <b>Stays on constantly</b> - Avoid using the parking brake and have your vehicle checked by a dealer immediately.</li> </ul>
		<ul style="list-style-type: none"> <li>• Comes on if there is a problem with the radar sensor.</li> <li>• Indicator may come on temporarily when the maximum permissible weight is exceeded.</li> </ul>	<ul style="list-style-type: none"> <li>• Make sure the total load is within the maximum permissible weight.   <b>Load Limit</b> P. 419</li> <li>• <b>Stays on constantly</b> - Have your vehicle checked by a dealer.</li> </ul>
		<ul style="list-style-type: none"> <li>• Comes on if the brake system is deactivated temporarily after the 12-volt battery has been disconnected, then re-connected.</li> </ul>	<ul style="list-style-type: none"> <li>• Drive a short distance at more than 20 km/h (12 mph). The indicator should go off. If it does not, have your vehicle checked by a dealer.</li> </ul>
	Automatic Brake Hold System Indicator	<ul style="list-style-type: none"> <li>• Comes on when the automatic brake hold system is on.</li> </ul>	 <b>Automatic Brake Hold</b> P. 594
	Automatic Brake Hold Indicator	<ul style="list-style-type: none"> <li>• Comes on when the automatic brake hold is activated.</li> </ul>	 <b>Automatic Brake Hold</b> P. 594





Indicator	Name	On/Blinking	Explanation
	Malfunction Indicator Lamp	<ul style="list-style-type: none"> <li>• Comes on if there is a problem with the emissions control systems or electric vehicle system.</li> <li>• Blinks when a misfire in the engine's cylinders is detected.</li> </ul>	<ul style="list-style-type: none"> <li>▶ <b>If the Malfunction Indicator Lamp Comes On or Blinks</b> P. 758</li> </ul>
	12-Volt Battery Charging System Indicator	<ul style="list-style-type: none"> <li>• Comes on when there is a problem with the charging system.</li> </ul>	<ul style="list-style-type: none"> <li>• Stop in a safe place and contact a dealer immediately.</li> <li>▶ <b>Checking the 12-Volt Battery</b> P. 715</li> <li>▶ <b>If the 12-Volt Battery Charging System Indicator Comes On</b> P. 757</li> </ul>
	Shift Position Indicator	<ul style="list-style-type: none"> <li>• Indicates the current shift position.</li> </ul>	<ul style="list-style-type: none"> <li>▶ <b>Shifting</b> P. 434</li> </ul>
	Transmission System Indicator	<ul style="list-style-type: none"> <li>• Blinks if the transmission system has a problem.</li> <li>• Blinks if you cannot select <b>P</b> due to a transmission system failure.</li> </ul>	<ul style="list-style-type: none"> <li>• Have your vehicle checked by a dealer immediately.</li> <li>• <b>Do not drive displays on the driver information interface</b> - Immediately stop in a safe place and contact a dealer.</li> <li>• Set the parking brake when parking.</li> <li>• Have your vehicle checked by a dealer immediately.</li> </ul>

Indicator	Name	On/Blinking	Explanation
	Deceleration Paddle Selector Indicator	<ul style="list-style-type: none"> <li>• Comes on when the paddle selector is pulled.</li> <li>• Blinks when deceleration does not occur while pulling the paddle selector.</li> <li>• Comes on with <b>M</b> when <b>SPORT</b> mode is selected or the shift position is in <b>[B]</b>, and the paddle selector is pulled.</li> </ul>	<p>📖 <b>Deceleration Paddle Selector</b> P. 440</p>
	Power System Indicator	<ul style="list-style-type: none"> <li>• Comes on if there is a problem with the electric vehicle system or plug-in charging system.</li> </ul>	<ul style="list-style-type: none"> <li>• <b>Stays on constantly</b> -Have your vehicle checked by a dealer immediately.</li> <li>• <b>Do not drive</b> displays on the driver information interface - Immediately stop in a safe place and contact a dealer.</li> </ul>
	Ready Indicator	<ul style="list-style-type: none"> <li>• Comes on when the vehicle is ready to drive.</li> </ul>	<p>📖 <b>Turning on the Power</b> P. 428</p>
	EV Indicator	<ul style="list-style-type: none"> <li>• Comes on when the vehicle is moved by the motor, and the engine is not operating.</li> </ul>	<p>—</p>
	Seat Belt Reminder Indicator	<ul style="list-style-type: none"> <li>• Comes on if you are not wearing a seat belt when you set the power mode to ON.</li> <li>• If the front passenger is not wearing a seat belt, the indicator comes on a few seconds later.</li> <li>• Comes on for a while when the rear seat belt is unfastened while the power mode in ON.</li> <li>• Blinks while driving if you and/or any passenger has not fastened a seat belt. The beeper sounds and the indicator blinks at regular intervals.</li> </ul>	<ul style="list-style-type: none"> <li>• The beeper stops and the indicator goes off when you and the passengers fasten their seat belts.</li> <li>• <b>Stays on after you and/or the passengers have fastened the seat belt(s)</b> - A detection error may have occurred in the sensor. Have your vehicle checked by a dealer. <ul style="list-style-type: none"> <li>📖 <b>Seat Belt Reminder</b> P. 51</li> </ul> </li> </ul>

Indicator	Name	On/Blinking	Explanation
	Low Fuel Indicator	<ul style="list-style-type: none"> <li>• Comes on when the fuel reserve is running low (approximately 7.0 Litres/1.54 Imp gal left).</li> </ul>	<ul style="list-style-type: none"> <li>• Refuel your vehicle as soon as possible.</li> </ul>
		<ul style="list-style-type: none"> <li>• Blinks if there is a problem with the fuel gauge.</li> </ul>	<ul style="list-style-type: none"> <li>• Have your vehicle checked by a dealer.</li> </ul>
	Anti-lock Brake System ( <b>ABS</b> ) Indicator	<ul style="list-style-type: none"> <li>• Comes on if there is a problem with the ABS.</li> </ul>	<ul style="list-style-type: none"> <li>• <b>Stays on constantly</b> - Have your vehicle checked by a dealer. With this indicator on, your vehicle still has normal braking ability but no anti-lock function.                      ➤ <b>Anti-lock Brake System (ABS)</b> P. 597</li> </ul>
	Supplemental Restraint System Indicator	<ul style="list-style-type: none"> <li>• Comes on if a problem with any of the following is detected:                             <ul style="list-style-type: none"> <li>- Supplemental Restraint System</li> <li>- Side airbag system</li> <li>- Side curtain airbag system</li> <li>- Seat belt tensioner</li> </ul> </li> </ul>	<ul style="list-style-type: none"> <li>• <b>Stays on constantly</b> - Have your vehicle checked by a dealer.</li> </ul>
	Passenger Front Airbag On/Off Indicators	<ul style="list-style-type: none"> <li>• When the passenger front airbag is active: The <b>ON</b> indicator comes back on and remains on for about 60 seconds.                      When the passenger front airbag is inactive: The <b>OFF</b> indicator comes back on and stays on. This is a reminder that the passenger front airbag is deactivated.</li> </ul>	<ul style="list-style-type: none"> <li>➤ <b>Passenger Front Airbag Off System</b> P. 67</li> </ul>







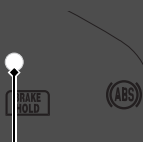



Indicator	Name	On/Blinking	Explanation
	Electric Power Steering (EPS) System Indicator	<ul style="list-style-type: none"> <li>Comes on if there is a problem with the EPS system.</li> </ul>	<ul style="list-style-type: none"> <li><b>Stays on constantly</b> - Have your vehicle checked by a dealer.</li> <li><b>Do not drive displays on the driver information interface</b> - Immediately stop in a safe place and contact a dealer.                             <ul style="list-style-type: none"> <li>➤ <b>If the Electric Power Steering (EPS) System Indicator Comes On</b> P. 760</li> </ul> </li> </ul>
	Vehicle Stability Assist (VSA) System Indicator	<ul style="list-style-type: none"> <li>Blinks when VSA, or trailer stability assist is active.</li> <li>Comes on if there is a problem with the VSA system, hill start assist system, agile handling assist or trailer stability assist.</li> <li>Comes on if the VSA system is deactivated temporarily after the 12-volt battery has been disconnected, then re-connected.</li> </ul>	<p style="text-align: center;">—</p> <ul style="list-style-type: none"> <li><b>Stays on constantly</b> - Have your vehicle checked by a dealer.                             <ul style="list-style-type: none"> <li>➤ <b>Vehicle Stability Assist (VSA) System</b> P. 466</li> <li>➤ <b>Hill start assist system</b> P. 430</li> <li>➤ <b>Agile Handling Assist</b> P. 468</li> <li>➤ <b>Trailer Stability Assist</b> P. 423</li> </ul> </li> <li>When <b>Trailer stability assist system problem</b> is displayed on the driver information interface, the VSA does not activate.</li> <li>Drive a short distance at more than 20 km/h (12 mph). The indicator should go off. If it does not, have your vehicle checked by a dealer.</li> </ul>
	Vehicle Stability Assist (VSA) <b>OFF</b> Indicator	<ul style="list-style-type: none"> <li>Comes on when you partially disable VSA.</li> </ul>	<ul style="list-style-type: none"> <li>➤ <b>Switching the Display</b> P. 164</li> <li>➤ <b>Vehicle Stability Assist Mode</b> P. 176</li> </ul>



Indicator	Name	On/Blinking	Explanation
	Low Tyre Pressure/Deflation Warning System Indicator	<ul style="list-style-type: none"> <li>• May come on briefly if the power mode is set to ON and the vehicle is not moved within 45 seconds, to indicate the initialise process is not yet complete.</li> <li>• Comes on and stays on when:                             <ul style="list-style-type: none"> <li>- One or more tyres' pressures are determined to be significantly low.</li> <li>- The system has not been initialised.</li> </ul> </li> </ul>	<ul style="list-style-type: none"> <li>• <b>Comes on while driving</b> - Stop in a safe place, check tyre pressures, and inflate the tyre(s) if necessary.</li> <li>• <b>Stays on after the tyres are inflated to the recommended pressures</b> - The system needs to be initialised.                             <ul style="list-style-type: none"> <li>➤ <b>Deflation Warning System Calibration</b> P. 469</li> </ul> </li> </ul>
		<ul style="list-style-type: none"> <li>• Blinks for about one minute, and then stays on if there is a problem with the deflation warning system.</li> </ul>	<ul style="list-style-type: none"> <li>• <b>Blinks and remains on</b> - Have your vehicle checked by a dealer.</li> </ul>
		<ul style="list-style-type: none"> <li>• Comes on if the deflation warning system is deactivated temporarily after the 12-volt battery has been disconnected, then reconnected.</li> </ul>	<ul style="list-style-type: none"> <li>• Drive a short distance at more than 20 km/h (12 mph). The indicator should go off. If it does not, have your vehicle checked by a dealer.</li> </ul>







Indicator	Name	On/Blinking	Explanation
	Turn Signal and Hazard Warning Indicators	<ul style="list-style-type: none"> <li>• Blinks when you operate the turn signal lever.</li> <li>• Blinks along with all turn signals when you press the hazard warning button.</li> </ul>	<ul style="list-style-type: none"> <li>• <b>Does not blink or blinks rapidly</b> - Have your vehicle checked by a dealer.</li> </ul>
		<ul style="list-style-type: none"> <li>• Blinks along with all turn signals when you depress the brake pedal while the high speed driving.</li> </ul>	<ul style="list-style-type: none"> <li>➤ <b>Emergency Stop Signal</b> P. 599</li> </ul>
	Lights On Indicator	<ul style="list-style-type: none"> <li>• Comes on when the position, tail, and other external lights are on.</li> </ul>	<ul style="list-style-type: none"> <li>➤ <b>Lights</b> P. 229</li> </ul>
	High Beam Indicator	<ul style="list-style-type: none"> <li>• Comes on when the high beam headlights are on.</li> <li>• Comes on when the adaptive driving beam is active.</li> </ul>	<ul style="list-style-type: none"> <li>➤ <b>Adaptive Driving Beam*</b> P. 238</li> </ul>
	Adaptive Driving Beam Indicator	<ul style="list-style-type: none"> <li>• Comes on when all the operating conditions of the adaptive driving beam are met.</li> </ul>	<ul style="list-style-type: none"> <li>➤ <b>Adaptive Driving Beam*</b> P. 238</li> </ul>
	Rear Fog Light Indicator	<ul style="list-style-type: none"> <li>• Comes on when the rear fog light is on.</li> </ul>	<ul style="list-style-type: none"> <li>➤ <b>Fog Light</b> P. 233</li> </ul>





Indicator	Name	On/Blinking	Explanation
 <p>Indicator</p>	<p>Immobilizer System Indicator</p>	<ul style="list-style-type: none"> <li>Blinks if the immobilizer system cannot recognise the key information.</li> </ul>	<ul style="list-style-type: none"> <li><b>Blinks</b> - You cannot start the power system. Set the power mode to VEHICLE OFF, then select the ON mode again.                             <ul style="list-style-type: none"> <li><b>Right-hand Drive Type</b> Depress and hold the brake pedal before setting the power mode to ON.</li> <li><b>All models</b></li> </ul> </li> <li><b>Repeatedly blinks</b> - The system may be malfunctioning. Have your vehicle checked by a dealer.</li> <li>Do not attempt to alter this system or add other devices to it. Electrical problems can occur.</li> </ul>
 <p>Indicator</p>	<p>Security System Alarm Indicator</p>	<ul style="list-style-type: none"> <li>Blinks when the security system alarm has been set.</li> </ul>	<p>➤ <b>Security System Alarm</b> P. 214</p>





Indicator	Name	On/Blinking	Explanation
 ECON	<b>ECON</b> Mode Indicator	<ul style="list-style-type: none"> <li>Comes on when you set the drive mode to <b>ECON</b>.</li> </ul>	<ul style="list-style-type: none"> <li>➤ <b>Drive Mode Switch</b> P. 445</li> </ul>
SPORT	<b>SPORT</b> Mode Indicator	<ul style="list-style-type: none"> <li>Comes on when you set the drive mode to <b>SPORT</b>.</li> </ul>	<ul style="list-style-type: none"> <li>The ambient meter and the gauges in the instrument panel light up in red as long as <b>SPORT</b> mode is selected.                             <ul style="list-style-type: none"> <li>➤ <b>Drive Mode Switch</b> P. 445</li> </ul> </li> </ul>
NORMAL	<b>NORMAL</b> Mode Indicator	<ul style="list-style-type: none"> <li>Comes on when you set the drive mode to <b>NORMAL</b>.</li> </ul>	<ul style="list-style-type: none"> <li>➤ <b>Drive Mode Switch</b> P. 445</li> </ul>
SNOW	<b>SNOW</b> Mode Indicator	<ul style="list-style-type: none"> <li>Comes on when you set the drive mode to <b>SNOW</b>.</li> </ul>	<ul style="list-style-type: none"> <li>➤ <b>Drive Mode Switch</b> P. 445</li> </ul>
TOW	<b>TOW</b> Mode Indicator	<ul style="list-style-type: none"> <li>Comes on when you set the drive mode to <b>TOW</b>.</li> </ul>	<ul style="list-style-type: none"> <li>➤ <b>Drive Mode Switch</b> P. 445</li> </ul>

Indicator	Name	On/Blinking	Explanation
 AUTO	<b>AUTO</b> Mode Indicator	<ul style="list-style-type: none"> <li>Comes on when you set the drive mode to <b>AUTO</b>.</li> </ul>	 <b>e Button</b> P. 19
 EV	<b>EV</b> Mode Indicator	<ul style="list-style-type: none"> <li>Comes on when you set the drive mode to <b>EV</b>.</li> </ul>	 <b>e Button</b> P. 19
 SAVE	<b>SAVE</b> Mode Indicator	<ul style="list-style-type: none"> <li>Comes on when you set the drive mode to <b>SAVE</b>.</li> </ul>	 <b>e Button</b> P. 19
 CHARGE	<b>CHARGE</b> Mode Indicator	<ul style="list-style-type: none"> <li>Comes on when you set the drive mode to <b>CHARGE</b>.</li> </ul>	 <b>e Button</b> P. 19
	Hill Descent Control System Indicator (White/Green)	<ul style="list-style-type: none"> <li>Lights up in white when the Hill Descent Control System is on and ready to use.</li> <li>Lights up in green when the Hill Descent Control System is in operation.</li> </ul>	 <b>Hill Descent Control System</b> P. 452

Indicator	Name	On/Blinking	Explanation
	System Message Indicator	<ul style="list-style-type: none"> <li>Comes on along with a beep when a problem is detected. A system message on the driver information interface appears at the same time.</li> </ul>	<ul style="list-style-type: none"> <li>While the indicator is on, roll the right selector wheel to see the message again.                             <ul style="list-style-type: none"> <li>Switching the Display P. 164</li> </ul> </li> <li>Refer to the Indicators information in this chapter when a system message appears on the driver information interface. Take the appropriate action for the message.</li> <li>The driver information interface will not return to the normal screen unless the warning is cancelled, or the right selector wheel is rolled.</li> </ul>
	Parking Sensor Indicator	<ul style="list-style-type: none"> <li>Blinks if there are obstacles around the sensors.</li> </ul>	<ul style="list-style-type: none"> <li>Parking Sensor System P. 602</li> </ul>
	Adaptive Cruise Control (ACC) with Low Speed Follow Indicator (Amber)	<ul style="list-style-type: none"> <li>Comes on if there is a problem with ACC with Low Speed Follow.</li> <li>Indicator may come on temporarily when the maximum permissible weight is exceeded.</li> <li>ACC with Low Speed Follow has been automatically cancelled.</li> <li>Comes on if the ACC with Low Speed Follow is deactivated temporarily after the 12-volt battery has been disconnected, then re-connected.</li> </ul>	<ul style="list-style-type: none"> <li><b>Comes on while driving</b> - Have your vehicle checked by a dealer.</li> <li>Make sure the total load is within the maximum permissible weight.                             <ul style="list-style-type: none"> <li>Load Limit P. 419</li> </ul> </li> <li><b>Stays on constantly</b> - Have your vehicle checked by a dealer.</li> <li>Drive a short distance at more than 20 km/h (12 mph). The indicator should go off. If it does not, have your vehicle checked by a dealer.</li> </ul>

Indicator	Name	On/Blinking	Explanation
	Adaptive Cruise Control (ACC) with Low Speed Follow Indicator (White/Green)	<ul style="list-style-type: none"> <li>• Lights up in white when you press the  button. You can switch between indicators by pressing the  button.</li> <li>• Lights up in green while the system is in operation.</li> </ul>	<p>➤ <b>Adaptive Cruise Control (ACC) with Low Speed Follow</b> P. 526</p>
			<p>➤ <b>Applying the Traffic Sign Recognition System's Suggested Speed Limit</b> P. 530</p>
	Adjustable Speed Limiter Indicator (White/Green)		<p>➤ <b>Adjustable Speed Limiter</b> P. 454</p>
	Intelligent Speed Limiter Indicator (White/Green)		<p>➤ <b>Intelligent Speed Limiter</b> P. 460</p>
	Adaptive Cruise Control (ACC) with Low Speed Follow Interval Indicator		<p>➤ <b>To Set or Change Following-interval</b> P. 544</p>



Indicator	Name	On/Blinking	Explanation
	Lane Keeping Assist System (LKAS) Indicator (Amber)	<ul style="list-style-type: none"> <li>Comes on if there is a problem with the LKAS.</li> </ul>	<ul style="list-style-type: none"> <li><b>Stays on constantly</b> - Have your vehicle checked by a dealer.</li> </ul>
		<ul style="list-style-type: none"> <li>Indicator may come on temporarily when the maximum permissible weight is exceeded.</li> </ul>	<ul style="list-style-type: none"> <li>Make sure the total load is within the maximum permissible weight.                             <ul style="list-style-type: none"> <li>➤ <b>Load Limit</b> P. 419</li> </ul> </li> <li><b>Stays on constantly</b> - Have your vehicle checked by a dealer.</li> </ul>
	Lane Keeping Assist System (LKAS) Indicator (White/Green)	<ul style="list-style-type: none"> <li>Lights up in white when you press the LKAS button.</li> <li>Lights up in green when the LKAS is in operation.</li> </ul>	<ul style="list-style-type: none"> <li>➤ <b>Lane Keeping Assist System (LKAS)</b> P. 550</li> <li>➤ <b>Traffic Jam Assist</b> P. 561</li> </ul>
	Active Lane Change Assist Indicator (Amber)	<ul style="list-style-type: none"> <li>Comes on if there is a problem with Active Lane Change Assist.</li> </ul>	<ul style="list-style-type: none"> <li><b>Stays on constantly</b> - Have your vehicle checked by a dealer.</li> </ul>
		<ul style="list-style-type: none"> <li>Indicator may come on temporarily when the maximum permissible weight is exceeded.</li> </ul>	<ul style="list-style-type: none"> <li>Make sure the total load is within the maximum permissible weight.                             <ul style="list-style-type: none"> <li>➤ <b>Load Limit</b> P. 419</li> </ul> </li> <li><b>Stays on constantly</b> - Have your vehicle checked by a dealer.</li> </ul>
	Active Lane Change Assist Indicator (White/Green)	<ul style="list-style-type: none"> <li>Lights up in white when the Active Lane Change Assist is ready to use.</li> <li>Lights up in green when the Active Lane Change Assist is in operation.</li> </ul>	<ul style="list-style-type: none"> <li>➤ <b>Active Lane Change Assist</b> P. 570</li> </ul>

Indicator	Name	On/Blinking	Explanation
	Collision Mitigation Braking System (CMBS) Indicator (Amber)	<ul style="list-style-type: none"> <li>Comes on if there is a problem with the CMBS or it cannot be used temporarily due to issues such as dirt on the windscreen near the camera.</li> </ul>	<ul style="list-style-type: none"> <li>The Safety Support Indicator (Amber) comes on at the same time.                             <ul style="list-style-type: none"> <li>➤ <b>Safety Support Indicator (Amber)</b> P. 135</li> </ul> </li> </ul>
	Collision Mitigation Braking System (CMBS) Indicator (Grey)	<ul style="list-style-type: none"> <li>Comes on when the CMBS is off.</li> </ul>	<ul style="list-style-type: none"> <li>➤ <b>Safety Support</b> P. 173</li> </ul>
	Road Departure Mitigation Indicator (Amber)	<ul style="list-style-type: none"> <li>Comes on if there is a problem with the Road Departure Mitigation System or it cannot be used temporarily due to issues such as dirt on the windscreen near the camera.</li> </ul>	<ul style="list-style-type: none"> <li>The Safety Support Indicator (Amber) comes on at the same time.                             <ul style="list-style-type: none"> <li>➤ <b>Safety Support Indicator (Amber)</b> P. 135</li> </ul> </li> </ul>
	Road Departure Mitigation Indicator (Grey)	<ul style="list-style-type: none"> <li>Comes on when the Road Departure Mitigation System is off.</li> </ul>	<ul style="list-style-type: none"> <li>➤ <b>Safety Support</b> P. 173</li> </ul>
	Road Departure Mitigation System Steering Assist Auto OFF indicator	<ul style="list-style-type: none"> <li>Comes on when the Road Departure Mitigation System steering assist is automatically turned off.</li> </ul>	<ul style="list-style-type: none"> <li>➤ <b>Road Departure Mitigation System</b> P. 510</li> </ul>

Indicator	Name	On/Blinking	Explanation
	Safety Support Indicator (Amber)	<ul style="list-style-type: none"> <li>Comes on if there is a problem with Road Departure Mitigation system, CMBS, Low Speed Braking Control, blind spot information system, Lane Change Collision Mitigation, or Front Cross Traffic Warning.</li> </ul>	<ul style="list-style-type: none"> <li><b>Stays on constantly</b> - Have your vehicle checked by a dealer.</li> </ul>
		<ul style="list-style-type: none"> <li>Comes on if there is a problem with the parking sensor.</li> </ul>	<ul style="list-style-type: none"> <li>Check if the area around the sensor(s) is covered with mud, ice, snow, etc. If the indicator stays on even after you clean the area, have the system checked by a dealer.</li> </ul>
		<ul style="list-style-type: none"> <li>Indicator may come on temporarily when the maximum permissible weight is exceeded.</li> </ul>	<ul style="list-style-type: none"> <li>Make sure the total load is within the maximum permissible weight.                             <ul style="list-style-type: none"> <li>📖 <b>Load Limit</b> P. 419</li> </ul> </li> <li><b>Stays on constantly</b> - Have your vehicle checked by a dealer.</li> </ul>
		<ul style="list-style-type: none"> <li>Comes on if the Road Departure Mitigation system, CMBS, Low Speed Braking Control, Lane Change Collision Mitigation, and Front Cross Traffic Warning are deactivated temporarily after the 12-volt battery has been disconnected and then re-connected.</li> </ul>	<ul style="list-style-type: none"> <li>Drive a short distance at more than 20 km/h (12 mph). The indicator should go off. If it does not, have your vehicle checked by a dealer.</li> </ul>

Indicator	Name	On/Blinking	Explanation
	<p>Safety Support Indicator (Amber)</p>	<ul style="list-style-type: none"> <li>Comes on when the Road Departure Mitigation system, CMBS, Lane Change Collision Mitigation, and/or Front Cross Traffic Warning shuts itself off.</li> </ul>	<ul style="list-style-type: none"> <li>Indicator may come on temporarily if the radar sensor cannot detect any objects when passing through an enclosed space such as a tunnel, or driving on an open road without any structures nearby.</li> <li>The area around the radar sensor is blocked by dirt, mud, etc. Stop your vehicle in a safe place and wipe the debris off with a soft cloth. Or, the area around the radar sensor is blocked because you are towing a trailer. This indicator may take some time to go off after the radar sensor is cleaned, or after the trailer that was being towed is removed.</li> <li>Have your vehicle checked by a dealer if this indicator does not go off even after you have cleaned the radar sensor and/or removed the trailer that was being towed. ➤ <b>Radar Sensor</b> P. 587</li> <li><b>Stays on</b> - The temperature inside the camera is too high. Use the climate control system to cool down the camera. The system activates when the temperature inside the camera cools down. ➤ <b>Front Sensor Camera</b> P. 585</li> </ul>

Indicator	Name	On/Blinking	Explanation
	Safety Support Indicator (Amber)	<ul style="list-style-type: none"> <li>Comes on when the Road Departure Mitigation system, CMBS, Lane Change Collision Mitigation, and/or Front Cross Traffic Warning shuts itself off.</li> </ul>	<ul style="list-style-type: none"> <li><b>Stays on</b> - The area around the camera is blocked by dirt, mud, etc. Stop your vehicle in a safe place and wipe the debris off with a soft cloth.</li> <li>Have your vehicle checked by a dealer if the indicator and message are still displayed even after you have cleaned the area around the camera.                             <ul style="list-style-type: none"> <li>📖 <b>Front Sensor Camera</b> P. 585</li> </ul> </li> <li>It may come on when the ambient conditions are dark, such as when driving in a tunnel, or at night, dawn, or dusk.</li> </ul>
		<ul style="list-style-type: none"> <li>Comes on when mud, snow, or ice accumulates in the vicinity of the blind spot information system sensor.</li> <li>Comes on when the temperature of the blind spot information system sensor is high.</li> </ul>	<ul style="list-style-type: none"> <li><b>Comes on while driving</b> - Something may be interfering with the blind spot information system sensor. Check the vicinity of the blind spot information system sensor and remove any obstacles.</li> <li>The system will return to normal when the temperature cools down.                             <ul style="list-style-type: none"> <li>📖 <b>Blind Spot Information System</b> P. 471</li> </ul> </li> </ul>
		<ul style="list-style-type: none"> <li>Comes on when mud, snow, or ice accumulates in the vicinity of the sonar sensor.</li> </ul>	<ul style="list-style-type: none"> <li>Remove the obstacle in the vicinity of the sonar sensor.                             <ul style="list-style-type: none"> <li>📖 <b>Low Speed Braking Control</b> P. 498</li> </ul> </li> </ul>

Indicator	Name	On/Blinking	Explanation
	Safety Support Indicator (Green/Grey)	<ul style="list-style-type: none"> <li>• Lights up in green when the Road Departure Mitigation system, CMBS, Low Speed Braking Control, blind spot information system, Lane Change Collision Mitigation, Front Cross Traffic Warning and Parking Sensor System are on.</li> <li>• Lights up in green and grey when one or more of the systems above are off.</li> <li>• Lights up in grey when all systems above are off.</li> </ul>	<ul style="list-style-type: none"> <li>➤ <b>Collision Mitigation Braking System (CMBS)</b> P. 484</li> <li>➤ <b>Road Departure Mitigation System</b> P. 510</li> <li>➤ <b>Low Speed Braking Control</b> P. 498</li> <li>➤ <b>Parking Sensor System</b> P. 602</li> <li>➤ <b>Blind Spot Information System</b> P. 471</li> <li>➤ <b>Lane Change Collision Mitigation</b> P. 518</li> <li>➤ <b>Front Cross Traffic Warning</b> P. 504</li> </ul>
	Driver Monitoring Camera Indicator (Amber)	<ul style="list-style-type: none"> <li>• Comes on if there is a problem with the driver monitoring camera.</li> </ul>	<ul style="list-style-type: none"> <li>• Also comes on if the camera cannot correctly detect the driver's condition.</li> <li>• Also comes on if the camera is dirty or covered by an obstacle. Stop your vehicle in a safe place and remove the dirt or obstacle.</li> <li>• Have your vehicle checked by a dealer if the indicator does not go off even after removing the dirt or obstacle.</li> <li>➤ <b>Driver Monitoring Camera</b> P. 588</li> </ul>
	Driver Monitoring Camera Indicator (Grey)	<ul style="list-style-type: none"> <li>• Comes on if the driver monitoring camera is temporarily stopped.</li> </ul>	<ul style="list-style-type: none"> <li>➤ <b>Driver Monitoring Camera</b> P. 588</li> </ul>

## Driver Information Interface Warning and Information Messages

---

The warning and information messages appear only on the driver information interface.

Roll the right selector wheel to see the message again with the system message indicator on.

### ■ Icons

Since messages will not display on the driver information interface when **Warning message** is set to OFF, you can check the messages below. Please take the appropriate action outlined in the message, such as contacting a dealer.





- **Red Icons** P. 139
- **Amber Icons** P. 141
- **Green Icons** P. 149
- **Other Icons** P. 149





Display messages by setting **Warning message** to ON via the audio/information screen. You can also change the message language.





- **Customized Features** P. 360



■ Red Icons

Icon	Message
	Critical system failure detected. Stop driving when safe
	Steering assist reduced. Stop driving when safe.
	Brake performance reduced. Stop driving when safe.
	Brake fluid low. Do not drive. Check fluid level.
	Parking brake engaged
	Release parking brake
	Cannot set cruise: Parking brake is applied
	Cruise cancelled: Parking brake was applied
	Brake system problem. Brake performance may be reduced.

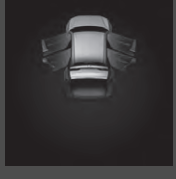



Icon	Message
	Brake system problem. Do not drive.
	Fasten seat belt
	Fasten passenger's seat belt
	➤ Seat Belt Reminder P. 51
	12 volt battery charging system problem. Do not drive.



Icon	Message
	<p><b>Engine oil pressure low.</b>  <b>Stop engine.</b>  <b>Do not drive.</b>                      ☑ If the Engine oil pressure low Warning Appears P. 757</p>
	<p><b>Engine temperature too hot.</b>  <b>Do not drive.</b>  <b>Allow engine to cool.</b>                      ☑ Overheating P. 755</p>
	<p><b>Supplemental restraint system problem</b></p>
	<p><b>Check rear seats</b></p>





Icon	Message
	<p><b>Door open</b></p>
	<p><b>Tailgate open</b></p>
	<p><b>Door and tailgate open</b></p>
	<p><b>Steering required</b></p>
	<p><b>Lane departure</b></p>



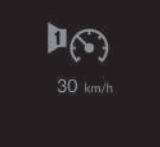



Icon	Message
	Parking sensor system problem
	Approaching object
	High voltage battery thermal problem. Stop driving when safe then evacuate the vehicle. ❏ If the High voltage battery thermal problem Warning Appears P. 763
	High voltage battery thermal problem. Apply parking brake then evacuate the vehicle. ❏ If the High voltage battery thermal problem Warning Appears P. 763
	High voltage battery thermal problem. Evacuate the vehicle. ❏ If the High voltage battery thermal problem Warning Appears P. 763







### ■ Amber Icons





Icon	Message
	Engine system problem. Power generation not available. Vehicle will stop in
	Apply parking brake to keep vehicle stationary
	<ul style="list-style-type: none"> <li>❏ Adaptive Cruise Control (ACC) with Low Speed Follow P. 526</li> <li>❏ Collision Mitigation Braking System (CMBS) P. 484</li> <li>❏ Low Speed Braking Control P. 498</li> </ul>
	Steering required
	Lane departure
	Lane change cancelled: Steering required





Icon	Message
	<b>Outside temperature low. Road surface may be frozen.</b>
	<b>Temperature too low for vehicle to operate</b>
	<b>Please wait while vehicle warms up</b>
	<b>➤ Speed Alarm P. 172</b>





Icon	Message
	<b>Emissions system problem. Power may be reduced.</b>
	<b>Emission system problem. Avoid strong acceleration and high speed.</b>
	<b>Emission system problem. Do not drive.</b>
	<b>Engine cooling system problem. Power may be reduced.</b>
	<b>Fuel gauge system problem. Level not accurate.</b>
	<b>Fuel low</b>
	<b>Fuel lid open</b>







Icon	Message
	Transmission system problem. Performance may be reduced.
	Transmission system problem. Apply parking brake when parked.
	Transmission system problem. Do not drive.
	Transmission system problem. Park not available.
	Shift to Park
	Neutral-hold mode ON. Shift to P when done







Icon	Message
	Anti-lock brake system problem. Brake performance may be reduced.
	Brake system problem. Brake performance may be reduced.
	Brake system problem. Do not depress Brake + Accelerator together.
	Brake system problem. Brake performance may be reduced.
	Brake system problem. Brake performance may be reduced.
	Reduced stopping power. Avoid heavy deceleration and high speed. <ul style="list-style-type: none"> <li>▣ If the Reduced stopping power Warning Appears P. 758</li> </ul>

Icon	Message
	<b>Brake system problem. Honda parking pilot not available.</b>
	<b>Electric parking brake system problem. Parking brake not available.</b>
	<b>Vehicle stability assist system problem. Traction and handling may be reduced.</b>
	<b>Systems initializing... Continue driving.</b>
	<b>Hill start assist problem. Vehicle may roll upon brake release.</b>
	<b>Brake hold system problem. Apply brake when stopped.</b>







Icon	Message
	<b>Brake hold disabled. Apply brake pedal.</b>
	<b>Cruise cancelled: Depress brake pedal</b>
	<b>Hill descent control system problem. Apply brake when descending.</b>
	<b>To release parking brake: Brake + Push</b>
	<b>Power tailgate system problem. operate tailgate manually.</b>





Icon	Message
	<p>Electric power steering system problem. Steering assist reduced.</p> <p>Electric power steering system problem. No steering assist. Do not drive.</p>
	<p>Look ahead: Driver attention not detected. Keep eyes on the road.</p>
	<p>Driver attention level low. Take a rest</p>
	<p>Driver attention monitor problem. Drowsiness and eye detection alerts may not work.</p>
	<p>Automatic lighting control system problem. Manual controls available.</p>

Icon	Message
	<p>Headlight system problem. Headlight performance may be reduced.</p>
	<p>Adaptive driving beam problem. Manual controls available.</p>
	<p>Keyless remote not detected</p>
	<p>Change keyless remote battery   Replacing the Remote Battery P. 721</p>
	<p>Smart entry system problem</p>
	<p>Digital key system problem</p>

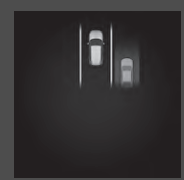

Icon	Message
	Carry digital key and switch vehicle OFF when exiting
	Tyre pressure monitor system problem
	Tyre pressures low. Check pressure in all tyres and initialise deflation warning system in vehicle settings.
	Adaptive cruise control system problem
	Collision mitigation braking system problem
	Low speed braking control problem.





Icon	Message
	Low speed braking control problem. Parking sensor obstructed.
	Lane keeping assist system problem
	Road departure mitigation system problem
	Trailer stability assist system problem
	Adaptive damper system problem
	Service due soon  Service Reminder System* P. 676

Icon	Message
	<b>Service due now</b> [Service Reminder System] * P. 676
	<b>Service overdue</b> [Service Reminder System] * P. 676
	<b>Honda parking pilot problem.</b> Honda parking pilot not available.
	<b>Blind spot information system problem</b>
	<b>Lane change collision mitigation system problem</b>
	<b>Blind spot information not available</b>

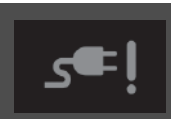

Icon	Message
	<b>Caution:</b> <b>Vehicle on right</b>
	<b>Caution:</b> <b>Vehicle on left</b>
	<b>Active lane change assist problem</b>
	<b>Check cross traffic</b>

\* Not available on all models







Icon	Message
	Front cross traffic warning problem
	Check charging system
	Power system temperature low. Power may be reduced.
	Power system temperature high. Power may be reduced.
	Power system problem. Power may be reduced.
	12 volt battery charging system problem. Power may be reduced.





Icon	Message
	Power system problem. Power may be reduced.
	Plug-in charging system problem. Range limited.
	Power system problem. Do not drive.
	Power system problem. Avoid strong acceleration and high speed.
	Acoustic vehicle alerting system problem
	Remove charging connector
	Charging connector release problem. Use release cord to disconnect.
	Charge lid open







■ Green Icons





Icon	Message
	Brake hold system standby
	Speed limit detected. Push "SET/-" to apply.



■ Other Icons

Icon	Message
	Outside temperature low. Road surface may be frozen.
	Engine temperature near limit. Avoid strong acceleration and high speed.
	Have you checked engine oil level lately? Check and reset in vehicle settings. ▶ Resetting Oil Level Check Reminder P. 702
	To shift: Depress brake pedal
	To shift: Release accelerator pedal
	Gear position is N. Release accelerator pedal.
	Transmission temperature near limit. Avoid strong acceleration and high speed.

Icon	Message
	<b>Cannot set cruise: Brake pedal is applied</b>
	<b>To shift: Vehicle must be stopped</b>
	<b>Gear unavailable. Wait and try again</b>
	<b>Brake hold system OFF</b>
	<b>To enable brake hold: Seat belt + Push</b>



Icon	Message
	<b>To disable brake hold: Brake + Push</b>
	<b>To enable brake hold: Fasten seat belt</b>
	<b>Fasten seat belt</b>
	<b>Cannot set cruise: Fasten seat belt</b>
	<b>Cruise cancelled: Fasten seat belt</b>
	<b>Driver attention level low</b>

Icon	Message
	Cannot set cruise: Speed too high
	Cruise cancelled: Speed too high
	Cannot set cruise: System not available
	Cruise cancelled: System not available
	Cruise will cancel soon
	Cannot set cruise: Too close to vehicle ahead
	Cruise cancelled: Too close to vehicle ahead
	Cannot set cruise: Slope too steep
	Cruise cancelled: Slope too steep
	Cannot set cruise: Slope too steep
	Cruise cancelled: Slope too steep

Icon	Message
	Cannot set cruise: Shift to Drive
	Cruise cancelled: Shift to Drive
	To resume cruise: Use "RES/+" switch
	Cruise cancelled: Loss of traction
	Press switch to operate
	Hold switch to operate ACC









Icon	Message
	Press switch to operate ACC
	Cannot set cruise: Hill descent control ON
	Press switch to operate ACC
	Low speed braking control activated. Object detected.
	Lane keeping assist cannot operate

Icon	Message
	Some driver assist systems cannot operate: Camera temperature too high
	Some driver assist system cannot operate: Clean front windscreen or poor viewing condition.
	Road departure mitigation activated
	Some driver assist systems available



Icon	Message
	<p><b>To start vehicle: Brake + Push</b></p>
	<p>Right-hand Drive Type <b>To start vehicle: Fully depress Brake + Push</b></p>
	<p><b>To continue to drive: Depress brake pedal and push switch</b></p>
	<p><b>Accessory mode</b></p>
	<p><b>To start, touch start button with emblem side of remote</b>                      ▣ If the Keyless Remote Battery is Weak                      P. 750</p>

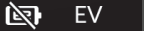

Icon	Message
	<p><b>Pressing button again twice or holding will cause ignition OFF &amp; power loss</b></p>
	<p><b>Cannot set hill descent control: Cruise is active</b></p>
	<p><b>Cannot set hill descent control: Speed too high</b></p>
	<p><b>Hill descent control OFF: Speed too high</b></p>
	<p><b>Hill decent control cancelled: Slope not steep enough</b></p>
	<p><b>Cannot set hill descent control: Cruise is active</b></p>

Icon	Message
	Cannot set hill descent control: Honda Parking Pilot is active
	Some driver assist systems cannot operate: Clean areas shown
	Please wait
	Ready
	Low ambient temperature. Charge connection recommended.
	Engine started for engine maintenance

Icon	Message
	EV mode not available. Reduce acceleration.
	EV mode not available, vehicle speed too high. Reduce vehicle speed.
	EV mode not available in current drive mode. Switch drive mode.
	EV mode not available, cabin heater active. Switch OFF heater.
	EV mode not available, battery low charge. Charging required.
	EV mode not available, engine too cold. Wait for engine temperature to increase.
	EV mode not available. Battery temperature out of range.
	EV mode not available. Engine self check started.
	EV mode not available

Icon	Message
	EV mode cancelled due to acceleration
	EV mode cancelled, cabin heater active.
	EV mode canceled, battery low charge. Charging required.
	EV mode cancelled, engine too cold. Wait for engine temperature to increase.
	EV mode cancelled
	EV mode not available. Engine started for oil circulation.
	EV mode cancelled. Engine started for oil circulation.

Icon	Message
	SAVE mode not available
	SAVE mode cancelled
	SAVE mode not available in current drive mode. Switch drive mode.
	CHARGE mode not available
	CHARGE mode complete. Previous mode selected.
	CHARGE mode cancelled
	CHARGE mode not available. Battery temperature out of range.
	CHARGE mode not available in current drive mode. Switch drive mode.
	CHARGE mode cancelled. Battery temperature out of range.
	Engine self-check started. Engine may start. EV mode continues during self-check.

Icon	Message
	EV range reduced due to low temperature
	EV range reduced due to low temperature. Charging recommended before next trip.
	Lane change unavailable
	Lane change unavailable: Lane occupied
	Lane change unavailable: Speed too low
	Lane change cancelled
	Lane change canceled: Lane occupied
	Lane change cancelled: Speed too low
	Lane change unavailable: Road condition not met
	Lane change cancelled: Road condition not met

## Gauges

Gauges include the speedometer, fuel gauge, and other related indicators. They are displayed when the power mode is in ON.

### ■ Speedometer

Displays your driving speed in km/h or mph.

### ■ Fuel Gauge

Displays the amount of fuel left in the fuel tank.

#### » Speedometer

You can change the Speed/Distance units.

» **Speed/Distance Units** P. 175

» **Customized Features** P. 360

#### » Fuel Gauge

##### NOTICE

You should refuel when the reading approaches **0**. Running out of fuel can cause the engine to misfire, damaging the catalytic converter.

After lightly refueling, or depending on your vehicle's condition, the actual amount of remaining fuel may differ from the fuel gauge reading.

## ■ POWER Gauge

Shows the output of the electric motor.

When driving in **EV** mode, the **POWER** gauge turns green and shows the value of the maximum output that can be driven in **EV** mode.

➔ **e Button** P. 19

## ■ CHARGE/DECEL Gauge

Shows the degree to which the High Voltage battery is being charged.

When the deceleration paddle selector is being used, it shows the strength of deceleration.

## ■ High Voltage Battery Charge Level Gauge

Shows the remaining high voltage battery charge level.

### ⌘ High Voltage Battery Charge Level Gauge

The high voltage battery charge level may decrease under the following conditions:

- When the 12-volt battery has been replaced.
- When the 12-volt battery has been disconnected.
- When the high voltage battery control system corrects its reading.

The charge level reading will be corrected automatically while driving.

Changes in the temperature of the High Voltage battery can cause the number of indicators in the battery charge level gauge to change.

## ■ Odometer

Shows the total number of kilometres or miles that your vehicle has accumulated.

## ■ Ambient Meter

Changes to green to indicate that the vehicle is being driven in a fuel-efficient manner with **SPORT** mode off.

## ■ Outside Temperature

Shows the outside temperature in Celsius.

If the outside temperature has been below 3°C at the time you set the power mode to ON, the  **Outside temperature low** message appears on the driver information interface.

### ■ Adjusting the outside temperature display

Adjust the temperature reading by up to  $\pm 3^{\circ}\text{C}$  if the temperature reading seems incorrect.

### ⊠ Outside Temperature

The temperature sensor is in the front bumper. Road heat and exhaust from another vehicle can affect the temperature reading when your vehicle speed is less than 30 km/h (19 mph).

It may take several minutes for the display to be updated after the temperature reading has stabilised.

### ⊠ Adjusting the outside temperature display

You can adjust the temperature reading.

 **Customized Features** P. 360

### ■ Traffic Sign Recognition System

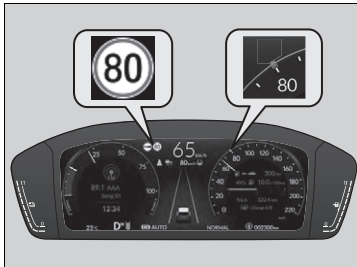

Shows certain detected traffic signs while driving.

The sign icon blinks when the maximum speed of the detected traffic sign is exceeded.

➤ **Traffic Sign Recognition System** P. 576

A green circle appears around the speed limit sign when ACC with Low Speed Follow suggests adjusting vehicle speed to match the speed limit indicated by the Traffic Sign Recognition System.

➤ **Applying the Traffic Sign Recognition System's Suggested Speed Limit** P. 530

### ■ Current Mode for ACC with Low Speed Follow, the LKAS, Traffic Jam Assist and Active Lane Change Assist

Shows the current mode for ACC with Low Speed Follow, LKAS, Traffic Jam Assist and Active Lane Change Assist.

➤ **Adaptive Cruise Control (ACC) with Low Speed Follow** P. 526

➤ **Lane Keeping Assist System (LKAS)** P. 550

➤ **Traffic Jam Assist** P. 561

➤ **Active Lane Change Assist** P. 570

➤ **Current Mode for ACC with Low Speed Follow, the LKAS, Traffic Jam Assist and Active Lane Change Assist**

When you set speed for ACC with Low Speed Follow, a set speed mark will be displayed on the speedometer.

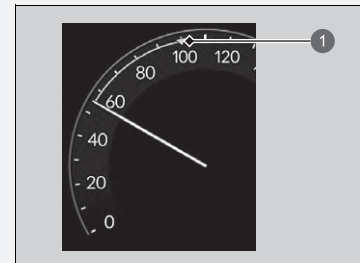

1 Set Speed

## Driver Information Interface Left Side Area

Shows the current mode for audio and phone information, etc.

▶ **Audio Remote Controls** P. 296

▶ **Hands-Free Telephone System** P. 379

### ■ Clock

Shows the clock.

#### ▶ Clock

You can adjust the time manually and change the clock display to show the 12 hour clock and 24 hour clock.

▶ **Clock** P. 188

You can choose whether the clock is displayed on the driver information interface.

▶ **Instrument Display Settings** P. 177

## ■ Customize Display

### ■ Arrange audio source on the left side area

You can choose which sources to display on the audio source screen.

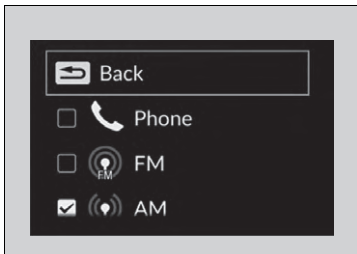
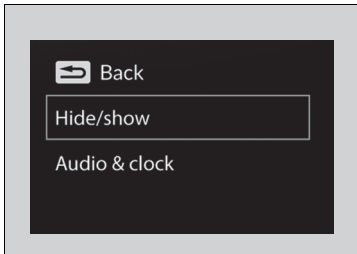
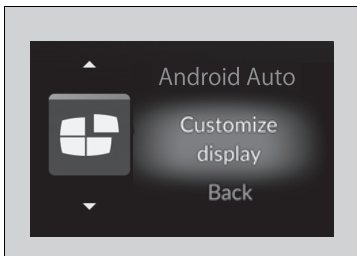

1. Roll the left selector wheel until **Customize display** is selected, then press the left selector wheel.

2. Roll the left selector wheel to scroll to select **Hide/show**, then press the left selector wheel.

3. Roll the left selector wheel to scroll between audio sources, then press the left selector wheel to check or uncheck them.

## ☒ Customize Display

When you customize settings, shift to **P**.

## ■ Turn the displaying on the left side area on and off

You can select whether the current audio information and clock appear on the left side area.

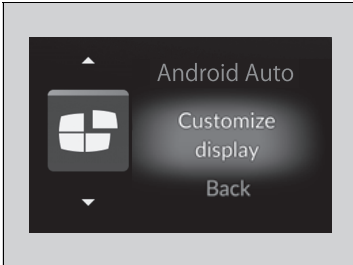

1. Roll the left selector wheel until **Customize display** is selected, then press the left selector wheel.

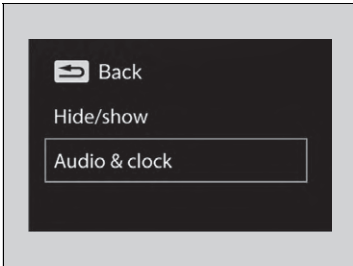

2. Roll the left selector wheel to scroll to select **Audio & clock**, then press the left selector wheel.

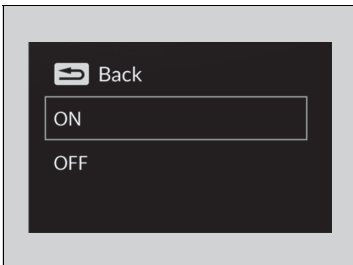



3. Roll the left selector wheel to scroll to select your desired settings, then press the left selector wheel.

## Driver Information Interface Right Side Area

The driver information interface shows information such as the estimated travelable distance and fuel economy of the vehicle. It also displays messages such as warnings and other helpful information.

When a warning message displays, please check the message and contact a dealer to have the vehicle inspected if necessary. Please refer to the pages below if the 

**Engine temperature too hot**,  **Engine oil pressure low**,  **Reduced stopping power**. or  **High voltage battery thermal problem**. message is displayed.

▶ **Overheating** P. 755

▶ **If the Engine oil pressure low Warning Appears** P. 757

▶ **If the Reduced stopping power Warning Appears** P. 758

▶ **If the High voltage battery thermal problem Warning Appears** P. 763

### Switching the Display

Roll the right selector wheel to view different types of content.

#### ▶▶ Switching the Display

You can add or delete the meter contents.

▶ **Instrument Display Settings** P. 177

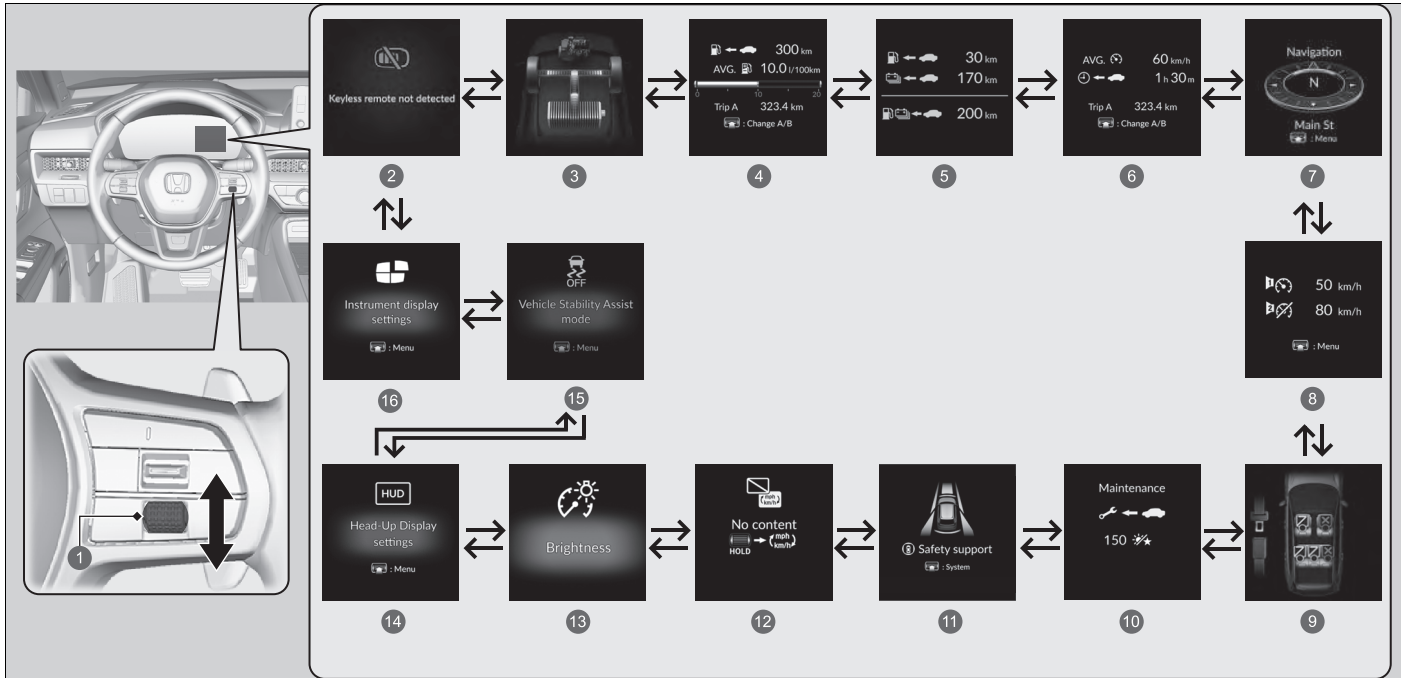

Instrument Panel

- |                                  |                               |   |
|----------------------------------|-------------------------------|---|
| 1 Right Selector Wheel           | 7 Navigation/Compass ▶ P. 171 | 12 No Content/Unit Change ▶ P. 175        |
| 2 Warning Message ▶ P. 178       | 8 Speed Alarm ▶ P. 172        | 13 Brightness ▶ P. 175                    |
| 3 Power Flow ▶ P. 166            | 9 Seat Belts ▶ P. 173         | 14 Head-Up Display Settings* ▶ P. 182     |
| 4 Range/Fuel/Trip Meter ▶ P. 167 | 10 Maintenance* ▶ P. 173      | 15 Vehicle Stability Assist Mode ▶ P. 176 |
| 5 Total Range ▶ P. 169           | 11 Safety Support ▶ P. 173    | 16 Instrument Display Settings ▶ P. 177   |
| 6 Speed/Time/Trip Meter ▶ P. 170 |                               |   |

\* Not available on all models

## ■ Power Flow Monitor

Displays the power flow of the motor and engine, indicating the vehicle's power source and whether the battery is being charged.

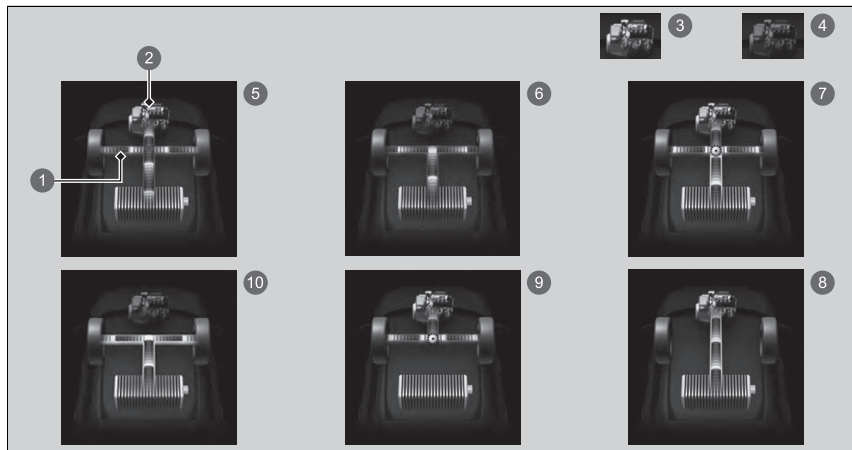

- ① Power Flow
- ② Engine
- ③ Engine ON
- ④ Engine OFF
- ⑤ **Hybrid (HV)**: Power is supplied by the motor and the engine.
- ⑥ **Electric Vehicle (EV)**: Power is supplied by the motor.
- ⑦ **Engine (Direct Drive)**: The engine is running and the motor is charging the High Voltage battery.
- ⑧ The engine is running and the motor is charging the High Voltage battery.
- ⑨ Power is being supplied by the engine only.
- ⑩ **Regeneration**: The motor is charging the High Voltage battery.

## ▶▶ Power Flow Monitor

While the vehicle is stationary with the engine running, the following may appear on the driver information interface.

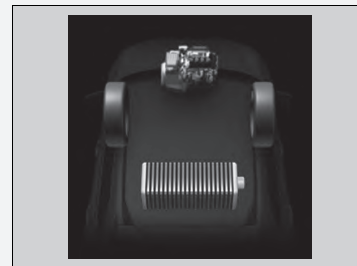

## Range / Fuel / Trip Meter

Press the right selector wheel to switch between trip meter A and trip meter B.

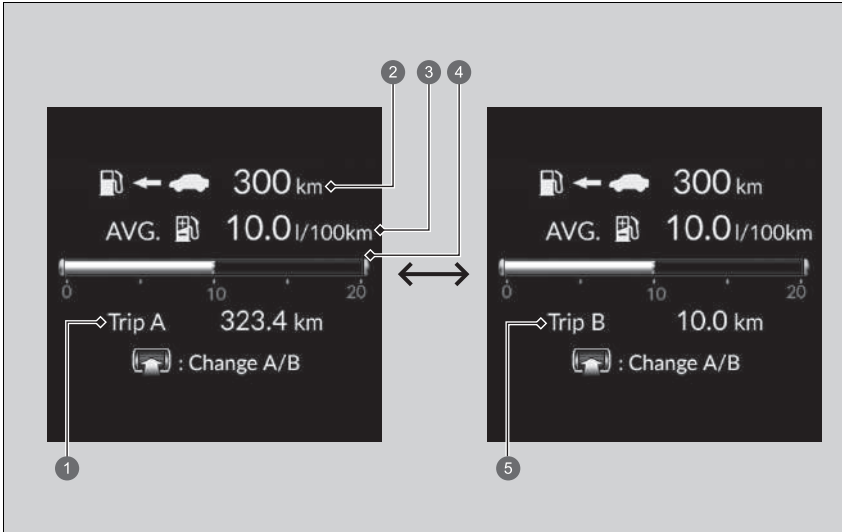

- ① Trip Meter A
- ② Range
- ③ Average Fuel Economy
- ④ Instant Fuel Economy
- ⑤ Trip Meter B

### ■ Trip meter

Shows the total number of kilometres or miles driven since the last reset. Meters A and B can be used to measure two separate trips.

### Resetting a trip meter

To reset the trip meter, display it, press and hold the right selector wheel, and then select **Reset**.

- ▶ The trip meter is reset to 0.0.

### ■ Average fuel economy

Shows the estimated average fuel economy of each trip meter in l/100 km or mpg. The display is updated at set intervals. When a trip meter is reset, the average fuel economy is also reset.

### ■ Instant fuel economy

Shows the instant fuel economy as a bar graph in l/100 km or mpg.

### ■ Range

Shows the estimated distance you can travel on the remaining power and fuel. This estimate is based on the fuel economy and energy consumption of your previous trips and the remaining High Voltage battery charge level.

#### » Average fuel economy

You can change when to reset the average fuel economy.

▶ **Customized Features** P. 360

#### » Range

The driving range displayed is only an estimate and may differ to the actual distance the vehicle can travel.

## ■ Total Range

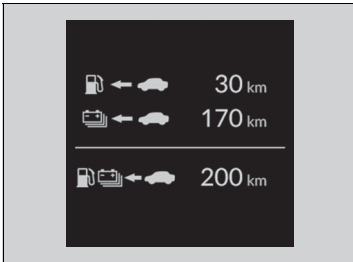

Shows the estimated distance you can travel using remaining electric and/or hybrid power. This estimate is based on the fuel economy and energy consumption of your previous trips and the remaining High Voltage battery charge level.

## ☒ Total Range

The displayed range may change even when the vehicle is stationary.

## ■ Speed/Time/Trip Meter

Press the right selector wheel to switch between trip meter A and trip meter B.

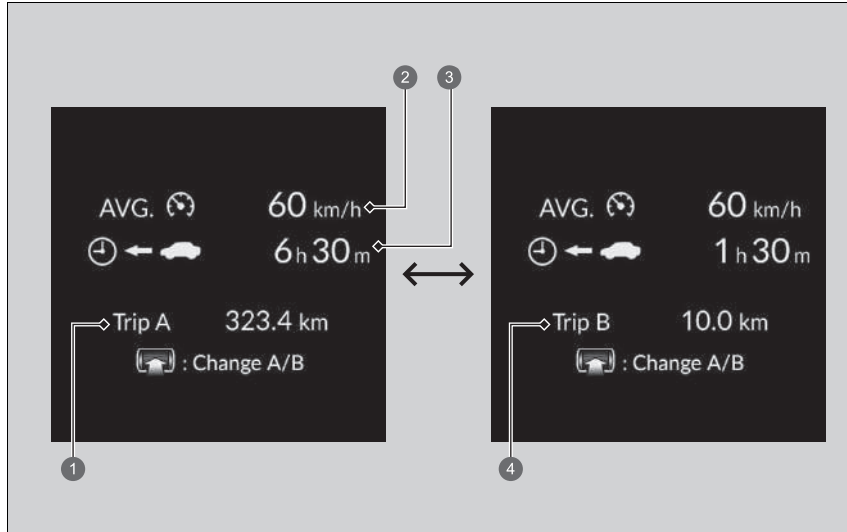

- ① Trip Meter A
- ② Average Speed
- ③ Elapsed Time
- ④ Trip Meter B

## ■ Trip meter

➤ **Trip meter** P. 168

## ■ Elapsed time

Shows the time elapsed since Trip A or Trip B was reset.

## ■ Average speed

Shows the average speed in km/h or mph since Trip A or Trip B was reset.

## ■ Navigation

### ■ Compass

Shows the compass screen.

### ■ Turn-by-Turn Directions

When driving guidance is provided by the navigation system, Android Auto or Apple CarPlay, turn-by-turn directions to your destination appear.

➤ **Refer to the Navigation System Manual**

➤ **Android Auto™** P. 348

➤ **Apple CarPlay** P. 343

### ⌘ Elapsed time

You can change when to reset the elapsed time.

➤ **Customized Features** P. 360

### ⌘ Average speed

You can change when to reset the average speed.

➤ **Customized Features** P. 360

### ⌘ Navigation

You can select whether to have the turn-by-turn display come on or not during the route guidance.

➤ **Customized Features** P. 360

Turn-by-turn directions may not be available for all apps.

When the compass or turn-by-turn directions are displayed, you can control some navigation system functions on the driver information interface by pressing the right selector wheel.

➤ **Refer to the Navigation System Manual**

## ■ Speed Alarm

Sets the speed alarm on and changes the speed alarm setting.

Press the right selector wheel to display the setting screen, then roll it, the speed alarm setting changes as follows:

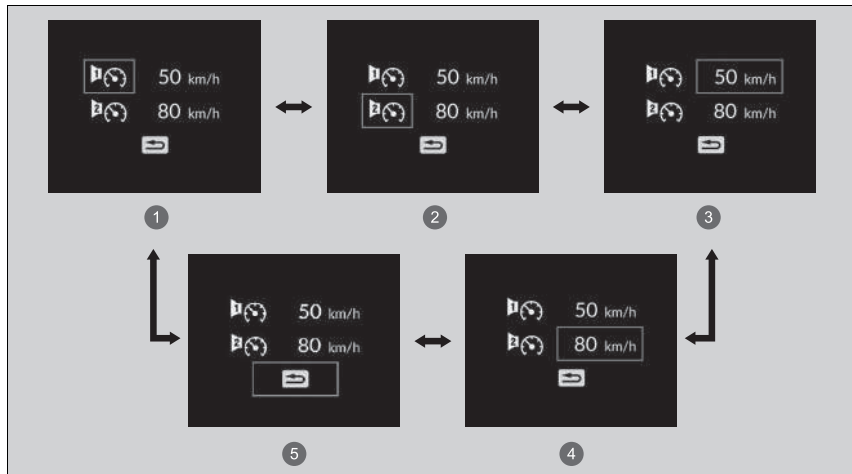

- ① Speed Alarm 1 On/Off\*1
- ② Speed Alarm 2 On/Off\*1
- ③ Speed Alarm 1 Speed Setting (50 km/h [30 mph]\*\*1)
- ④ Speed Alarm 2 Speed Setting (80 km/h [50 mph]\*\*1)
- ⑤ Back

\*1:Default Setting

## ■ Seat Belts

Occurs, under specified conditions, when seat belts are latched or unlatched.

🔧 **Seat Belt Reminder** P. 51

## ■ Maintenance\*

Show the service reminder system.

🔧 **Service Reminder System\*** P. 676

## ■ Safety Support

Indicates the status of the Road Departure Mitigation system, CMBS, Low Speed Braking Control, Blind Spot Information System, Lane Change Collision Mitigation, Front Cross Traffic Warning, and Parking Sensor System, such as On, Off, or Failure, by colour and letters.

The following colours indicate the status of any of the above-mentioned systems:

- Green: The system is on.
- Grey: The system is off.
- Amber: There is a problem with the system.

### 🔧 Safety Support

If a system is indicated by the colour amber, have your vehicle checked by a dealer immediately.

To turn each system on or off, first press the right selector wheel to switch displays. From the next display, you can select which system to turn on or off.

- 🔧 **Collision Mitigation Braking System (CMBS)** P. 484
- 🔧 **Road Departure Mitigation System** P. 510
- 🔧 **Low Speed Braking Control** P. 498
- 🔧 **Parking Sensor System** P. 602
- 🔧 **Blind Spot Information System** P. 471
- 🔧 **Lane Change Collision Mitigation** P. 518
- 🔧 **Front Cross Traffic Warning** P. 504

\* Not available on all models

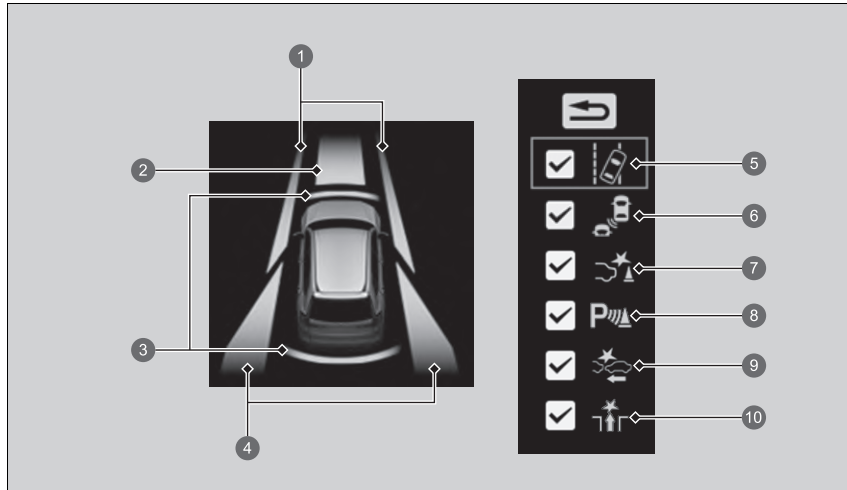

- ① Area Info for Road Departure Mitigation System
- ② Area Info for CMBS and Front Cross Traffic Warning
- ③ Area Info for Low Speed Braking Control and Parking Sensor System
- ④ Area Info for Blind Spot Information System or Lane Change Collision Mitigation
- ⑤ Road Departure Mitigation System Icon and Status Info
- ⑥ Blind Spot Information System or Lane Change Collision Mitigation Icon and Status Info
- ⑦ Low Speed Braking Control Icon and Status Info
- ⑧ Parking Sensor System Icon and Status Info
- ⑨ CMBS Icon and Status Info
- ⑩ Front Cross Traffic Warning Icon and Status Info

### ▶▶ Safety Support

You can also confirm the status of each function by the colour of the indicator.

- ▶ **Collision Mitigation Braking System (CMBS) Indicator (Amber)** P. 133
- ▶ **Collision Mitigation Braking System (CMBS) Indicator (Grey)** P. 133
- ▶ **Road Departure Mitigation Indicator (Amber)** P. 133
- ▶ **Road Departure Mitigation Indicator (Grey)** P. 133
- ▶ **Road Departure Mitigation System Steering Assist Auto OFF indicator** P. 133
- ▶ **Safety Support Indicator (Amber)** P. 134
- ▶ **Safety Support Indicator (Green/Grey)** P. 137

Even when the Low Speed Braking Control icon is green, if the **Rear sensor setting** is turned off, the brake assist will not operate when reversing.

- ▶ **Customized Features** P. 360

Even when the Parking Sensor System icon is green, if the **Rear Sensor Setting** is turned off, the rear parking sensor will not operate when reversing.

- ▶ **Customized Features** P. 360

## Speed/Distance Units



Enables you to show another unit on the driver information interface, head-up display\* and audio/information screen and set the displayed measurements to read in either km and km/h or miles and mph.

Press and hold the right selector wheel when you select the **No content** screen on the driver information interface. Each time you do this, the unit will change from km and km/h to miles and mph or vice versa. After this, a confirmation screen will appear for a few seconds.

## Brightness

Press the right selector wheel when the **Brightness** screen is displayed.

When the power mode is in ON, you can use the right selector wheel to adjust instrument panel brightness.

**Brighten:** Roll the right selector wheel up.

**Dim:** Roll the right selector wheel down.

Press the right selector wheel to exit.

## Brightness

The brightness of the gauge is automatically adjusted depending on the ambient brightness.

- The brightness decreases when the ambient light is dark.
- The brightness increases when the ambient light is bright.

You can change the setting even when the ambient lighting is bright, but the brightness of the gauge won't change.

\* Not available on all models

## ■ Vehicle Stability Assist Mode

You can turn the VSA on or off.

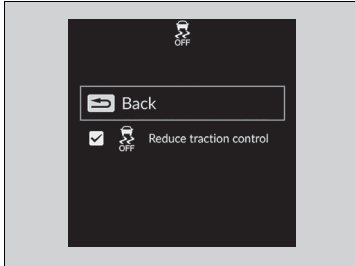

Roll the right selector wheel to scroll to select **Reduce traction control**, then press the right selector wheel to check or uncheck it.

### ▶ Vehicle Stability Assist (VSA) System

P. 466

## Instrument Display Settings

### ■ Arrange content on the right side area

You can choose which contents to display on the right side area.

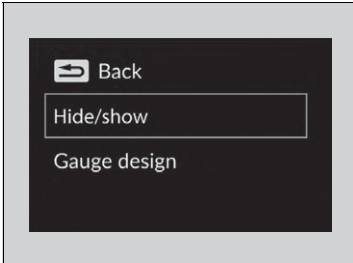

1. Press the right selector wheel when you select the **Instrument display settings** on the driver information interface.
2. Roll the right selector wheel to scroll to select **Hide/show**, then press the right selector wheel.

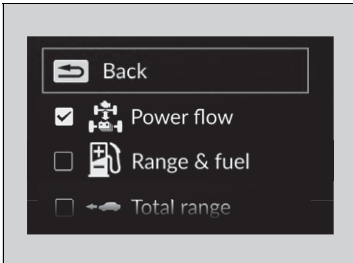

3. Roll the right selector wheel to scroll between contents, then press the right selector wheel to check or uncheck them.

### ▶▶ Arrange content on the right side area

Contents that are grey cannot be removed from the right side area.

When you customize settings, shift to **[P]**.

## ■ Change gauge design

You can change the gauge design.

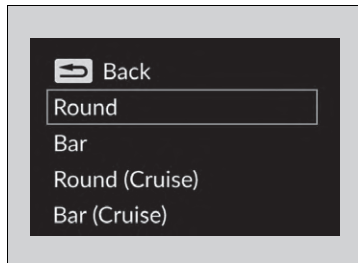
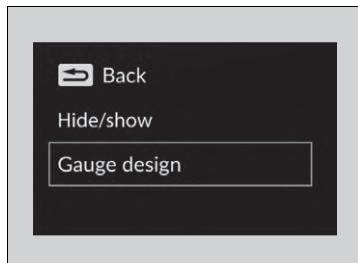

1. Press the right selector wheel when you select the **Instrument display settings** on the driver information interface.
2. Roll the right selector wheel to scroll to select **Gauge design**, then press the right selector wheel.
3. Roll the right selector wheel to scroll to select your desired settings, then press the right selector wheel.

## ▶▶ Change gauge design

When using the **Round (Cruise)** or **Bar (Cruise)** gauge design, a simplified display is used when ACC with Low Speed Follow is in operation.

## ▶▶ Warnings

If there are multiple warnings or informations, you can roll the right selector wheel to see other warnings.

## ■ Warnings

You can check if there are any active warning messages.

▶ **Driver Information Interface Warning and Information Messages** P. 138

## Head-Up Display\*

Shows the current mode for ACC with Low Speed Follow, LKAS, and Traffic Jam Assist; compass or turn-by-turn directions; and vehicle speed. You can choose which item to be displayed using the driver information interface. They are displayed when the power mode is in ON.

The display also shows the following messages.

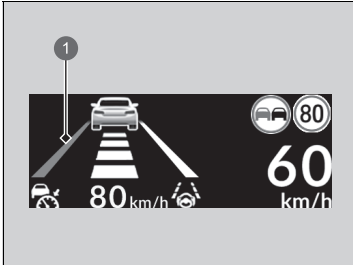

① Lane Departure Warning

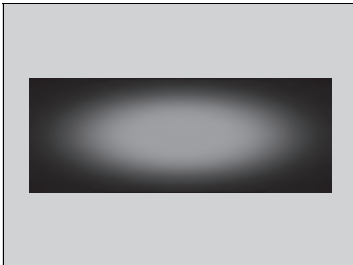

- **Lane Departure Warning:** When your vehicle is too close to the traffic lane lines, the lane departure warning appears.

➤ **Road Departure Mitigation System**

P. 510

➤ **Lane Keeping Assist System (LKAS)**

P. 550

➤ **Traffic Jam Assist** P. 561

- **Head-up Warning Lights:** Flash when the  message appears on the driver information interface.

➤ **Collision Mitigation Braking System (CMBS)** P. 484

➤ **Low Speed Braking Control** P. 498

➤ **Adaptive Cruise Control (ACC) with Low Speed Follow** P. 526

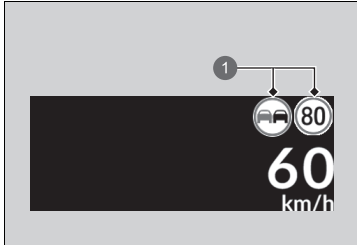

1 Traffic signs

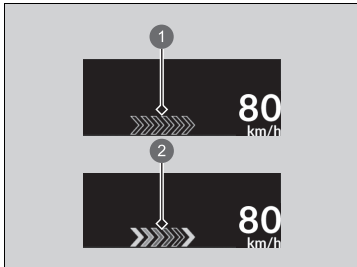

1 Standby  
2 Activated

- **Traffic Sign Recognition System:** Shows certain detected traffic signs while driving. The sign icon blinks when the maximum speed of the detected traffic sign is exceeded.

▶ **Traffic Sign Recognition System** P. 576

A green circle appears around the speed limit sign when ACC with Low Speed Follow suggests adjusting vehicle speed to match the speed limit indicated by the Traffic Sign Recognition System.

▶ **Applying the Traffic Sign Recognition System's Suggested Speed Limit** P. 530

- **Active Lane Change Assist:** The lane change indicator appears when the Active Lane Change Assist is activated.

▶ **Active Lane Change Assist** P. 570

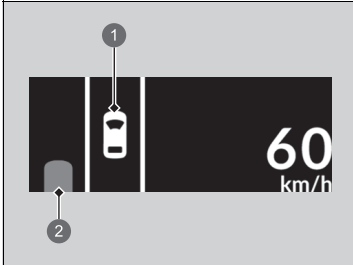

- ① Your vehicle
- ② Approaching vehicle

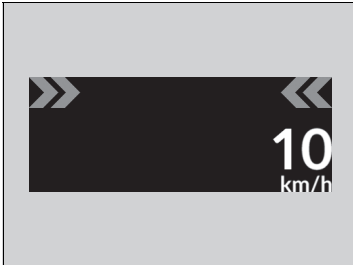

- **Lane Change Collision Mitigation**  
**Warning:** Appears if the risk of collision with a vehicle approaching from behind in an adjacent lane is detected while the Lane Change Collision Mitigation system is in operation.  
 ➤ **Lane Change Collision Mitigation**  
 P. 518
- **Front Cross Traffic Warning:** When your vehicle detects vehicles approaching from the front corners, the vehicle detection arrows appears.  
 ➤ **Front Cross Traffic Warning** P. 504

## ■ Head-Up Display Settings

Shows the display for changing the head-up display settings on the driver information interface.

Roll the right selector wheel to scroll to select **Head-Up Display settings**, then press the right selector wheel.

➤ **Switching the Display** P. 164

### ■ To change head-up display content

1. Roll the right selector wheel to scroll to select **HUD content**, then press the right selector wheel.
2. Roll the right selector wheel to scroll to select desired item, then press the right selector wheel.
  - **Speedometer**
    - **Speedometer** P. 185
  - **Navigation**
    - **Navigation** P. 185
  - **Driver assist**
    - **Current Mode for ACC with Low Speed Follow, LKAS, and Traffic Jam Assist** P. 185
  - **OFF**

## ☒ Head-Up Display Settings

### HUD content

➤ **To change head-up display content** P. 182

### HUD brightness

➤ **Adjusting the head-up display brightness**  
P. 184

### HUD height

➤ **Adjusting the head-up display height**  
P. 184

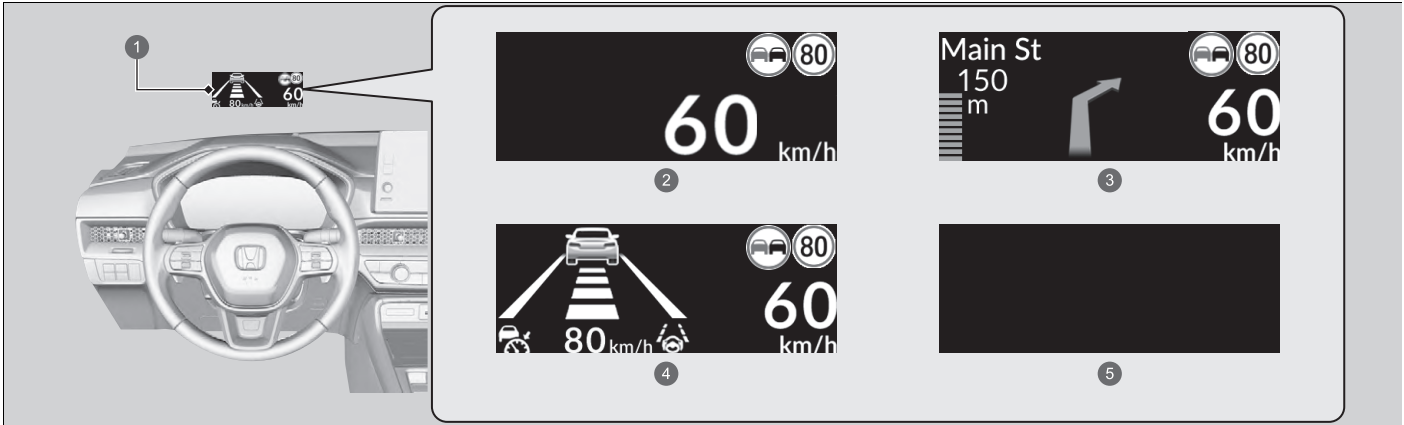

- ① Head-Up Display
- ② **Speedometer**
- ③ **Navigation**
- ④ **Driver assist**
- ⑤ **OFF**

### ■ Adjusting the head-up display brightness

Roll the right selector wheel to scroll to select **HUD brightness**, then press the right selector wheel.

**Brighten:** Roll the right selector wheel up.

**Dim:** Roll the right selector wheel down.

Press the right selector wheel to exit.

### ■ Adjusting the head-up display height

Roll the right selector wheel to scroll to select **HUD height**, then press the right selector wheel.

**Raise the head-up display:** Roll the right selector wheel up.

**Lower the head-up display:** Roll the right selector wheel down.

Press the right selector wheel to exit.

### ▶▶ Adjusting the head-up display height

When you unlock and open the driver's door with a remote transmitter or keyless access system, the head-up display adjusts automatically to one of the two preset positions.

## ■ Speedometer

Shows your driving speed in km/h or mph.

## ■ Current Mode for ACC with Low Speed Follow, LKAS, and Traffic Jam Assist

Shows the current mode for ACC with Low Speed Follow, LKAS, and Traffic Jam Assist.

- **Adaptive Cruise Control (ACC) with Low Speed Follow** P. 526
- **Lane Keeping Assist System (LKAS)** P. 550
- **Traffic Jam Assist** P. 561

## ■ Navigation

### ■ Compass

Shows the compass screen.

### ■ Turn-by-Turn Directions

When driving guidance is provided by the navigation system, Android Auto or Apple CarPlay, turn-by-turn directions to your destination appear.

- **Refer to the Navigation System Manual**
- **Android Auto™** P. 348
- **Apple CarPlay** P. 343

## ☒ Speedometer

You can change the Speed/Distance units.

- **Speed/Distance Units** P. 175
- **Customized Features** P. 360

## ☒ Navigation

You can select whether the turn-by-turn display comes on during the route guidance.

- **Customized Features** P. 360

Turn-by-turn directions may not be available for all apps.



# Controls

This chapter explains how to operate the various controls necessary for driving.

<b>Clock</b> .....	188	Security System Alarm.....	214	Adaptive Driving Beam* .....	238
<b>Locking and Unlocking the Doors</b>		Ultrasonic Sensors* .....	216	Wipers and Washers .....	241
Key .....	189	Tilt Sensor* .....	217	Rear Demister/Heated Door Mirror	
Low Keyless Remote Signal Strength ....	191	Super Locking* .....	218	Button .....	244
Locking/Unlocking the Doors from the		<b>Windows</b> .....	220	Driving Position Memory System* ....	245
Outside .....	192	<b>Panoramic Roof</b> .....	223	Adjusting the Steering Wheel .....	247
Locking/Unlocking the Doors from the		<b>Operating the Switches Around the</b>		<b>Mirrors</b> .....	248
Inside .....	199	<b>Steering Wheel</b>		<b>Seats</b> .....	251
Childproof Door Locks .....	201	POWER Button.....	227	<b>Interior Convenience Items</b> .....	263
<b>Tailgate</b> .....	202	Lights.....	229	<b>Climate Control System</b> .....	283
<b>Security System</b>		Active Cornering Lights* .....	235		
Immobilizer System .....	213	Headlight Adjuster* .....	237		

\* Not available on all models

## Adjusting the Clock

You can adjust the time in the clock display with the power mode in ON.

You can adjust the clock and customize the clock display.

➤ **Clock Setup** P. 309

### ▶▶ Adjusting the Clock

The clock in the instrument panel also changes when the audio/information screen clock is adjusted.

## Key

This vehicle comes with the following key:



Use the keys to turn on and off the power system, lock and unlock all the doors, tailgate, and charge lid.

### Key

All the keys have an immobilizer system. The immobilizer system helps to protect against vehicle theft.

#### **Immobilizer System** P. 213

Follow the advice below to prevent damage to the keys:

- Do not leave the keys in direct sunlight, or in locations with high temperature or high humidity.
- Do not drop the keys or set heavy objects on them.
- Keep the keys away from liquids, dust, and sand.
- Do not take the keys apart except for replacing the battery.

If the circuits in the keys are damaged, the power system may not activate, and the remote transmitter may not work.

If the keys do not work properly, have them inspected by a dealer.

### ■ Built-in Key

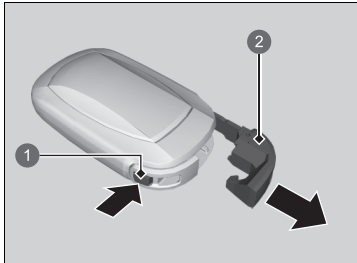

The built-in key can be used to unlock the doors when the keyless remote battery becomes weak and the power door unlock operation is disabled.

To remove the built-in key, push the release button and then pull out the key. To reinstall the built-in key, push the built-in key into the keyless remote until it clicks.

- ① Release Button
- ② Built-in Key

### ■ Key Number Tag

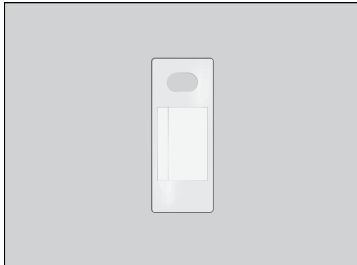

Contains a number that you will need if you purchase a replacement key.

### ▣ Key Number Tag

Keep the key number tag separate from the key in a safe place outside of your vehicle. If you wish to purchase an additional key, contact a dealer.

If you lose your key and you cannot activate the power system, contact a dealer.

## Low Keyless Remote Signal Strength

The vehicle transmits radio waves to locate the keyless remote to activate the power system, lock and unlock all the door, tailgate, and charge lid.

In the following cases, activating the power system may not work, locking/unlocking the doors/tailgate/charge lid may be inhibited or operation may be unstable:

- Strong radio waves are being transmitted by nearby equipment.
- You are carrying the keyless remote together with telecommunications equipment, laptop computers, mobile phones, or wireless devices.
- A metallic object is touching or covering the keyless remote.

### ⌘ Low Keyless Remote Signal Strength

Communication between the keyless remote and the vehicle consumes the keyless remote's battery.

Battery life is about two years, but this varies depending on regularity of use.

The battery is consumed whenever the keyless remote is receiving strong radio waves. Avoid placing it near electrical appliances such as televisions and personal computers.

It is possible to reduce battery consumption by turning off radio wave reception. When you hold down the lock and unlock buttons at the same time for approximately three seconds, the LED will blink twice and radio wave reception will turn off. If you press any button on the keyless remote once, it will begin receiving radio waves again.

## Locking/Unlocking the Doors from the Outside

### ■ Using the Keyless Access System

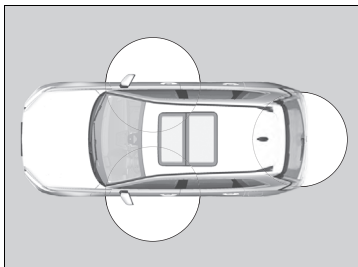

When you carry the keyless remote, you can lock/unlock the doors, tailgate, and charge lid. You can lock/unlock the doors and tailgate within a radius of about 80 cm (32 inches) from the outside door handle or tailgate outer handle.

### ▶▶ Locking/Unlocking the Doors from the Outside

If the interior light switch is in the door activated position, the interior light comes on when you unlock the doors.

No doors opened: The light fades out after 30 seconds.

Doors relocked: The light goes off immediately.

▶ **Interior Lights** P. 263

### ▶▶ Using the Keyless Access System

If you do not open a door or the tailgate within 30 seconds of unlocking the vehicle with the keyless access system, the doors and tailgate will automatically relock.

You can lock or unlock doors using the keyless access system only when the power mode is in VEHICLE OFF.

### ▶▶ Right-hand Drive Type

The keyless access system will not lock the vehicle when a door is open.

## ■ Locking the doors and tailgate

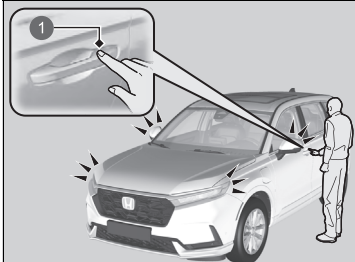

1 Door Lock Sensor

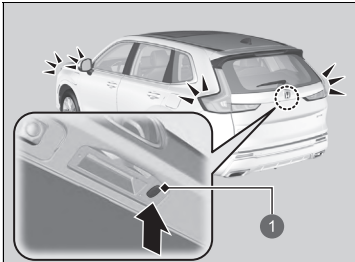

1 Lock Button

Touch the door lock sensor on the front door or press the lock button on the tailgate.

- ▶ Some exterior lights flash three times; all the doors and tailgate lock; and the security system sets.

### Right-hand Drive Type

- ▶ The super locking function is activated.

### ⊗ Using the Keyless Access System

- Do not leave the keyless remote in the vehicle when you get out. Carry it with you.
- Even if you are not carrying the keyless remote, you can lock/unlock the doors and the tailgate while someone else with the keyless remote is within range.
- The door may be unlocked if the door handle is covered with water in heavy rain or in a car wash if the keyless remote is within range.
- If you grip a front door handle or touch a door lock sensor wearing gloves, the door sensor may be slow to respond or may not respond by locking or unlocking the doors.
- After locking the door, you have up to 2 seconds during which you can pull the door handle to confirm whether the door is locked. If you need to unlock the door immediately after locking it, wait at least 2 seconds before gripping the handle, otherwise the door will not unlock.
- The door may not open if you pull it immediately after gripping the door handle. Grip the handle again and confirm that the door is unlocked before pulling the handle.
- Even within the 80 cm (32 inches) radius, you may not be able to lock/unlock the doors and the tailgate with the keyless remote if it is above or below the outside handle.
- The keyless remote may not operate if it is too close to the door, door glass, and tailgate.

## ■ Unlocking the doors and tailgate

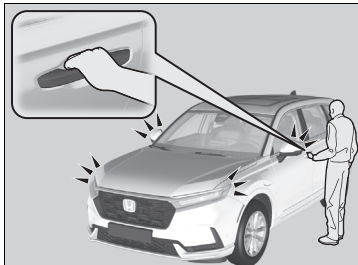

Grab the driver's door handle:

- ▶ The driver's door and charge lid unlocks.
- ▶ Some exterior lights flash once.

Grab the front passenger's door handle:

- ▶ All doors, tailgate, and charge lid unlock.
- ▶ Some exterior lights flash once.

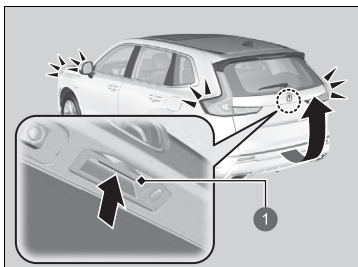

Press the outer handle:

- ▶ The tailgate unlocks.
- ▶ Some exterior lights flash once.
- ▶ **Opening/Closing the Tailgate** P. 203

① Outer Handle

## ▶▶ Using the Keyless Access System

The light flash and door unlock mode settings can be customized using the audio/information screen.

- ▶ **How to Customize the Vehicle Settings**  
P. 368

You can also unlock and open with the power tailgate.

- ▶ **Using the Tailgate Outer Handle** P. 209

## ■ Lock Presetting\*

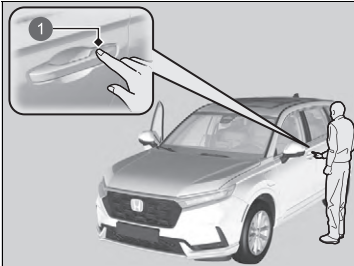

1 Door Lock Sensor

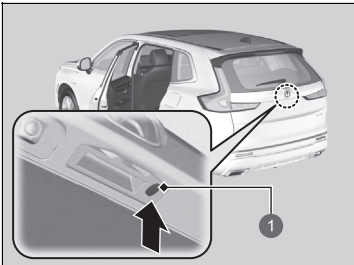

1 Lock Button

The vehicle will automatically lock after you lock the doors in advance then close the doors and tailgate.

Activate lock presetting after closing the driver's door.

1. Touch the door lock sensor on the front door, press the lock button on the tailgate or press the lock button on the keyless remote.

▶ Lock presetting is activated.

2. Close all doors and the tailgate.

▶ Some exterior lights flash when vehicle locks.

Make sure the doors and tailgate are locked before moving away from the vehicle.

## ☒ Lock Presetting\*

### ⚠ WARNING

Opening or closing the power tailgate on someone's hands or fingers can cause serious injury. Make sure all hands and fingers, especially children's, are clear of the power tailgate.

Lock presetting will be reset if a door or the tailgate is opened before the vehicle has locked completely.

Before locking a door, make sure that the key is not inside the vehicle.

You can turn this function on and off.

#### ☒ How to Customize the Vehicle Settings

P. 368

## ■ Using the Remote Transmitter

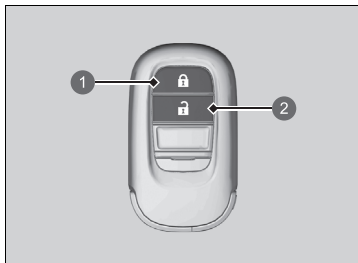

- ① Lock Button
- ② Unlock Button



### ■ Locking the doors and tailgate

Press the lock button.

- ▶ Some exterior lights flash three times, all the doors, tailgate, and charge lid lock, and the security system sets.

#### Right-hand Drive Type

- ▶ The super locking function is activated.

### ■ Unlocking the doors and tailgate

Press the unlock button.

#### Once:

- ▶ Some exterior lights flash once, and the driver's door and charge lid unlocks.

#### Twice:

- ▶ The remaining doors and tailgate unlock.

## ▶▶ Using the Remote Transmitter

If you do not open a door or the tailgate within 30 seconds of unlocking the vehicle with the remote transmitter, the doors and tailgate will automatically relock.

You can lock or unlock doors using the remote transmitter only when the power mode is in VEHICLE OFF.

#### Right-hand Drive Type

You cannot lock any doors from the outside when the keyless remote is inside the vehicle, and the beeper sounds. If you want to lock a door while the remote is still in the vehicle, do any of the following four times:

- Press the lock button on the keyless remote.
- Turn the key in the cylinder to lock.
- Touch the door lock sensor on the front door or press the lock button on the tailgate.

The remote transmitter uses low-power signals, so the operating range may vary depending on the surroundings.

#### Right-hand Drive Type

The remote will not lock the vehicle when a door is open.

## ■ Unlocking the Doors Using a Key

If the unlock button of the keyless remote does not work, use the key instead. The keyhole is on the back of the door handle.

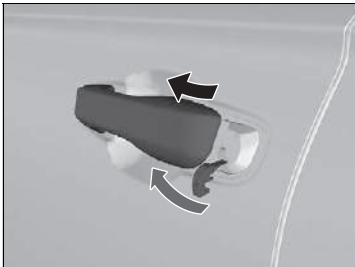

Insert the built-in key into the key cylinder from below the handle and then turn it.

### Right-hand Drive Type

The super locking function is cancelled and then the driver's door is unlocked.

### ▶▶ Using the Remote Transmitter

If the distance at which the remote transmitter works varies, the battery is probably low.  
If the LED does not come on when you press a button, the battery is dead.

▶▶ **Replacing the Remote Battery** P. 721

You can customize the door unlock mode setting.

▶▶ **How to Customize the Vehicle Settings**  
P. 368

### ▶▶ Unlocking the Doors Using a Key

When unlocking, the driver's door unlocks first. Turning the key a second time within a few seconds does not unlock the remaining doors and the tailgate.

If you unlock a door with the built-in key while the security system is activated, the alarm will sound.

You can customize the door unlock mode setting.

▶▶ **How to Customize the Vehicle Settings**  
P. 368

If the lock button of the keyless remote does not work, refer to the following.

▶▶ **Locking a Door Without Using a Key** P. 198

## ■ Locking a Door Without Using a Key

If you do not have the key on you, or if for some reason you cannot lock a door using the key, you can lock the door without it.

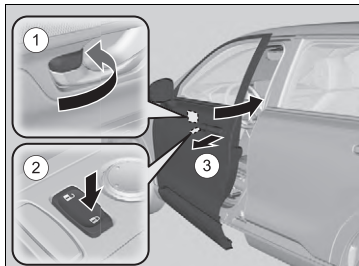

### ■ Locking the driver's door

Push the lock tab forward ① or push the master door lock switch in the lock direction ②, then pull and hold the outside door handle ③. Close the door, then release the handle.

### ■ Locking the passenger's doors

Push the lock tab forward and close the door.

### ■ Lockout prevention system

The doors and tailgate cannot be locked when the keyless remote is inside the vehicle.

### ▶▶ Locking a Door Without Using a Key

When you lock the driver's door, all the other doors and tailgate lock at the same time.

Before locking a door, make sure that the key is not inside the vehicle.

## Locking/Unlocking the Doors from the Inside

### ■ Using the Lock Tab

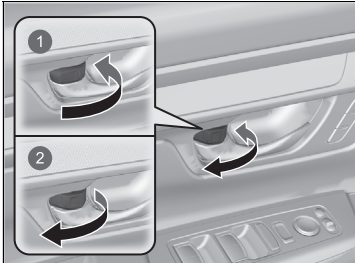

- ① To lock
- ② To unlock

#### ■ Locking a door

Push the lock tab forward.

#### ■ Unlocking a door

Pull the lock tab rearward.

### ☒ Using the Lock Tab

When you lock the door using the lock tab on the driver's door, all the other doors, tailgate, and charge lid lock at the same time.

When you unlock the door using the lock tab on the driver's door, only the driver's door will unlock.

## ■ Unlocking Using the Front Door Inner Handle

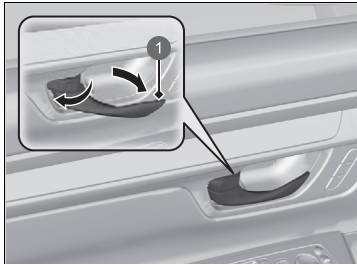

1 Inner Handle

Pull the front door inner handle.

- ▶ The door unlocks and opens in one motion.

## ■ Using the Master Door Lock Switch

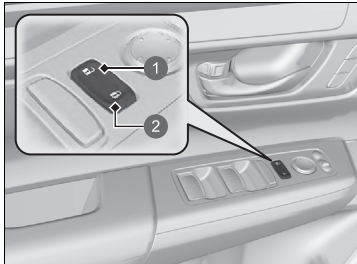

- 1 To unlock
- 2 To lock

## ▶▶ Unlocking Using the Front Door Inner Handle

The front door inner handles are designed to allow front seat occupants to open the door in one motion. However, this feature requires that front seat occupants never pull a front door inner handle while the vehicle is in motion.

Children should always ride in a rear seat where childproof door locks are provided.

▶ **Childproof Door Locks** P. 201

## ▶▶ Using the Master Door Lock Switch

When you lock/unlock either of the front doors using the master door lock switch, all the other doors, tailgate, and charge lid lock/unlock at the same time.

## Childproof Door Locks

The childproof door locks prevent the rear doors from being opened from the inside regardless of the position of the lock tab.

### ■ Setting the Childproof Door Locks

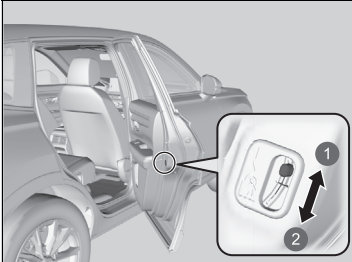

- 1 Unlock
- 2 Lock

Slide the lever in the rear door to the lock position, and close the door.

### ■ When opening the door

Open the door using the outside door handle.

### ☒ Childproof Door Locks

To open the door from the inside when the childproof door lock is on, put the lock tab in the unlock position, lower the rear window, put your hand out of the window, and pull the outside door handle.

## Precautions for Opening/Closing the Tailgate

Always make sure individuals and objects are clear of the tailgate before opening or closing it.

Keep the tailgate closed while driving to:

- ▶ Avoid possible damage.
- ▶ Prevent exhaust gas from leaking into the vehicle.
  - ❑ **Carbon Monoxide Gas** P. 113

### Precautions for Opening/Closing the Tailgate

#### **WARNING**

Anyone caught in the path of a tailgate that is being opened or closed can be seriously injured.

Make sure that all people are clear of the tailgate before opening or closing it.

Be careful not to hit your head on the tailgate or to put your hands between the tailgate and the luggage area when closing the tailgate.

When you are storing or picking up luggage from the luggage area or by using a forward and back kicking motion under the centre of the rear bumper for hands free access, while the engine is idling, do not stand in front of the exhaust pipe. You may get burned.

Do not allow any passenger in the luggage space. They may get hurt during hard braking, a sudden acceleration, or a crash.

## Opening/Closing the Tailgate

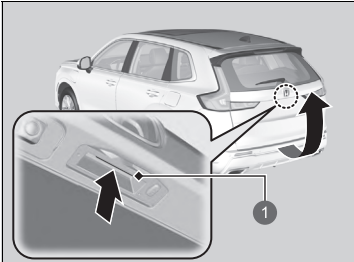

1 Outer Handle

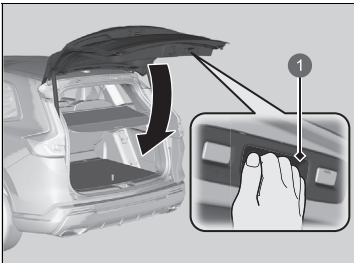

1 Inner Handle

When all the doors are unlocked, the tailgate is unlocked.

Press the outer handle of the tailgate for more than one second, and lift open the tailgate. If you are carrying the keyless remote, you do not have to unlock the tailgate before opening it.

To close the tailgate, grab the inner handle, pull the tailgate down, and push it closed from outside.

If you close the tailgate when the driver's door is locked, the tailgate locks automatically.

- ▶ Some exterior lights flash three times.

### ⊠ Precautions for Opening/Closing the Tailgate

Make sure luggage or other items do not touch the tailgate support struts.

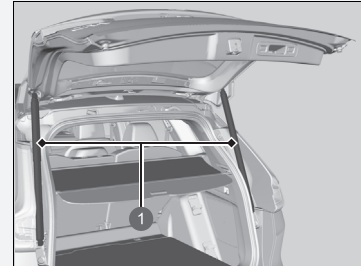

1 Tailgate Support Struts

### ⊠ Opening/Closing the Tailgate

- Do not leave the keyless remote in the vehicle when you get out. Carry it with you.
- Even if you are not carrying the keyless remote, you can unlock the tailgate while someone else with the keyless remote is within range.
- Do not leave the keyless remote inside the luggage area and close the tailgate. The beeper sounds and the tailgate cannot be closed.

## Opening/Closing the Power Tailgate

The power tailgate can be operated by pressing the power tailgate button on the remote transmitter, pressing the power tailgate button on the driver side control panel, pressing the outer handle or inner button on the tailgate, or by raising and lowering your foot under the centre of the rear bumper for hands free access.

The power tailgate can be opened/closed when the transmission is in **P**.

### ▶▶ Opening/Closing the Power Tailgate

#### **WARNING**

Opening or closing a power tailgate while any part of a passenger is in the tailgate's operating path can cause serious injury.

Make sure all passengers or objects are clear of the tailgate operating range before opening or closing the tailgate.

**WARNING:** Always take the ignition key with you whenever you leave the vehicle alone or with other occupants.

#### **NOTICE**

Do not push or pull on the power tailgate when it is being automatically opened or closed. Forcibly opening or closing the power tailgate while in operation can deform the tailgate frame.

When operating the power tailgate, make sure there is enough space around your vehicle. People near the tailgate may be seriously hurt if the tailgate hits or closes on their heads. Be especially cautious if children are around.

## ■ Using the Hands Free Access

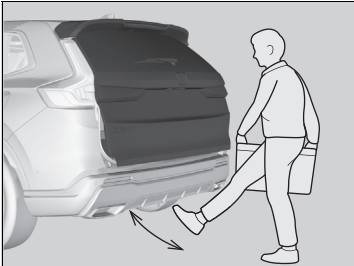

Use a forward and back kicking motion for about 1 second under the centre of the rear bumper to open or close the power tailgate while carrying the keyless remote.

- ▶ Some exterior lights will flash, then the tailgate begins to move.

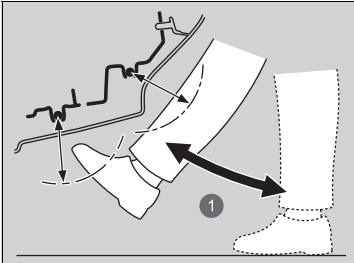

① About 1 second

## ☒ Using the Hands Free Access

During rain or in other instances when the vehicle becomes wet, the sensor may not properly detect your foot motion.

When performing work on or around the rear section of the vehicle, you may inadvertently open or close the tailgate.

To prevent this from happening, select Customized Features on the audio/information screen and then select OFF for the feature.

### ☒ How to Customize the Vehicle Settings P. 368

If you hold your foot under the bumper for too long or sweep your foot from side to side, the power tailgate does not open or close.

This function will not operate if you don't have the keyless remote on you. Please make sure you have the keyless remote on you.

## ■ Power Tailgate Walk Away Close

When you walk away from the vehicle while carrying the keyless remote, the power tailgate will automatically close.

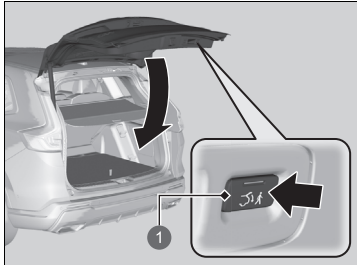

1 Walk Away Close Button

1. Carry the keyless remote and press the walk away close button.
  - The indicator on the walk away close button will turn green when the walk away close is activated.

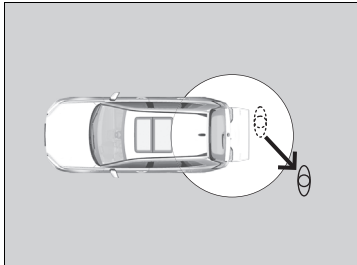

Walk at least 1.0 m (3 feet) away

2. Walk at least 1.0 m (3 feet) away from the vehicle within 30 seconds of pressing the walk away close button.
  - Some exterior lights will flash then the power tailgate begins to close.

## ■ Using the Remote Transmitter

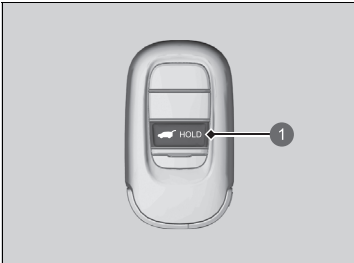

① Power Tailgate Button

Press the power tailgate button for more than one second to operate when the power mode is in VEHICLE OFF.

▶ Some exterior lights will flash.

If you press the button again while the power tailgate is moving, it will stop. Press the button for more than one second, and the power tailgate will reverse direction.

## ■ Customizing when to open the tailgate

**Anytime:** The power tailgate unlocks and opens at the same time. This is the default setting.

**When unlocked:** The tailgate opens when all doors are unlocked.

🔧 **How to Customize the Vehicle Settings** P. 368

## 🔧 Opening/Closing the Power Tailgate

The power tailgate may not open or close under the following conditions:

- You activate the power system while the tailgate is automatically opening or closing.
- The vehicle is parked on a steep hill.
- The vehicle is swayed in a strong wind.
- The tailgate or the roof is covered with snow or ice.

If you close the power tailgate when all the doors are locked, the power tailgate locks automatically and some exterior lights will flash.

If you replace the 12-volt battery or the power tailgate fuse while the tailgate is open, the power tailgate may be disabled. The power tailgate resumes once you manually close the tailgate.

Installing aftermarket components other than Honda genuine accessories on the power tailgate may prevent it from fully opening or closing.

Make sure the power tailgate is fully open before you get your luggage in and out.

The beeper sounds when you start driving while the power tailgate is still open, or closing.

## ■ Using the Power Tailgate Button

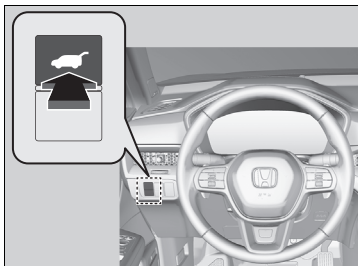

To open or close the power tailgate, press the power tailgate button for about one second.

- Some exterior lights will flash.

If you press the button again while the power tailgate is moving, it will stop.

Press the button for about one second, and the power tailgate will reverse direction.

## ▣ Opening/Closing the Power Tailgate

If the power tailgate meets resistance while opening or closing, the auto reverse feature reverses the direction. The beeper sounds three times.

The auto reverse function stops sensing when the tailgate is almost closed to make sure that it fully closes.

Do not touch the sensors located on both sides of the tailgate. The power tailgate does not close if you touch either sensor when you are trying to close the tailgate.

Be careful not to scratch the sensors with a sharp object. If scratched, they can be damaged, and the power tailgate closing feature malfunctions.

## ■ Using the Tailgate Outer Handle

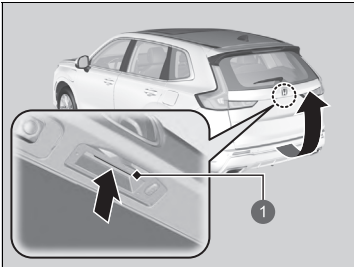

① Outer Handle

If you press the outer handle of the tailgate for no longer than one second, the tailgate opens automatically.

- ▶ If you want to open the tailgate manually, press the outer handle for more than one second.

🔧 **Opening/Closing the Tailgate** P. 203

If you are carrying the keyless remote, you do not have to unlock the tailgate before opening it.

If you press the outer handle again while the power tailgate is moving, it will stop. Press the outer handle, and the power tailgate will reverse direction.

## 🔧 Using the Tailgate Outer Handle

- Do not leave the keyless remote in the vehicle when you get out. Carry it with you.
- Even if you are not carrying the keyless remote, you can unlock the tailgate while someone else with the keyless remote is within range.
- Do not leave the keyless remote inside the luggage area and close the tailgate. The beeper sounds and the tailgate cannot be closed.

You can change the power tailgate operation setting on and off.

🔧 **How to Customize the Vehicle Settings**  
P. 368

## ■ Using the Tailgate Inner Button

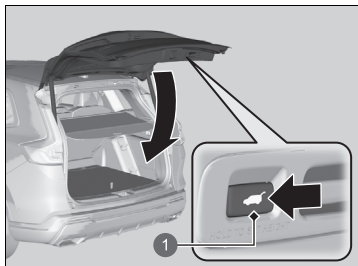

1 Tailgate Inner Button

Press the tailgate inner button on the tailgate to close the power tailgate.

If you press the tailgate inner button again while the power tailgate is moving, it will stop. Press and release the tailgate inner button again, and the power tailgate will reverse direction.

## ■ Programming Tailgate Position

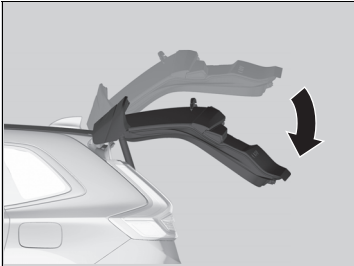

The extent to which the power tailgate automatically opens can be programmed.

To program:

**1.** Open the tailgate to the desired position.

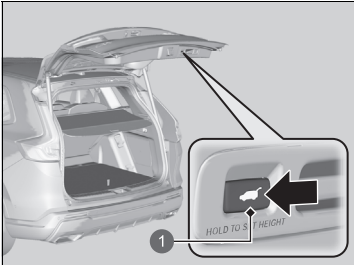

**2.** Press and hold the tailgate inner button. You will hear one long beep, followed by two short beeps.

**1** Tailgate Inner Button

### ☒ Programming Tailgate Position

If the tailgate is only slightly opened, the position cannot be programmed, even if you push the tailgate inner button.

If you want to reprogram the power tailgate to open all the way, manually raise the tailgate to its upper most position and follow directions for step 2.

## ■ Auto-Closer

If you manually close the power tailgate, it latches automatically.

## ■ Power Tailgate Fall Detection

Automatically lowers the power tailgate when there is a possibility that the fully opened power tailgate can fall down by its own weight (for example, with snow on the tailgate). The beeper sounds while the power tailgate lowers.

### » Auto-Closer

The auto-closer feature does not activate if you push the tailgate outer handle while the power tailgate is closing.

#### NOTICE

Do not put any force on the tailgate while the power tailgate is latching.

Keep your hands away from the tailgate when you manually close the tailgate and let it latch automatically. It is dangerous to put your hands around the tailgate as it starts to latch itself.

### » Power Tailgate Fall Detection

If you try to manually close the power tailgate immediately after it fully opens, the power tailgate fall detection may activate.

Once the power tailgate fall detection activates, wait until the power tailgate fully closes. Keep away from the power tailgate when it is in motion.

If the power tailgate fall detection constantly activates, consult at a dealer.

## Immobilizer System

This system prevents a key that has not been pre-registered from starting the power system.

Pay attention to the following when pressing the **POWER** button:

- Do not allow objects that emit strong radio waves near the **POWER** button.
- Make sure the key is not covered by or touching a metal object.
- Do not bring a key from another vehicle's immobilizer system near the **POWER** button.

Do not put the key near magnetic items. Electronic device, such as televisions and audio systems emit strong magnetic fields. Note that even a key chain can become magnetic.

### Immobilizer System

#### NOTICE

Leaving the key in the vehicle can result in theft or accidental movement of the vehicle. Always take the key with you whenever you leave the vehicle unattended.

Do not alter the system or add other devices to it. Doing so may damage the system and make your vehicle inoperable.

If the system repeatedly does not recognise the coding of your key, contact a dealer. If you have lost your key and cannot start your vehicle, contact a dealer.

#### Right-hand Drive Type

Apply and hold the brake pedal before set the power mode to ON the first time after the 12-volt battery has been disconnected.

## Security System Alarm

The security system alarm activates when the tailgate, bonnet, or doors are forcibly opened. The alarm does not activate if the tailgate or doors are opened with the remote transmitter or keyless access system.

### ■ When the security system alarm activates

The horn sounds intermittently, and some the exterior lights flash.

### ■ To deactivate the security system alarm

Unlock the vehicle using the remote transmitter or keyless access system, or turn the power mode to ON. The system, along with the horn and flashing lights, is deactivated.

### ■ Setting the security system alarm

The security system alarm automatically sets when the following conditions have been met:

- The power mode is set to VEHICLE OFF.
- The bonnet is closed.
- All doors and the tailgate are locked from outside with the remote transmitter or keyless access system.

### ■ When the security system alarm sets

The security system alarm indicator in the instrument panel blinks and the blinking interval changes after about 15 seconds.

### ■ To cancel the security system alarm

The security system alarm is cancelled when the vehicle is unlocked using the remote transmitter or keyless access system, or when the power mode is set to ON. The security system alarm indicator goes off at the same time.

### ⌘ Security System Alarm

Do not alter the system or add other devices to it. Doing so may damage the system and make your vehicle inoperable.

The security system alarm will continue for approximately 5 minutes before the security system deactivates.

The system will go through ten 30-second cycles, during which the horn will sound and an emergency indicator will flash.

Depending on circumstances, the security system may continue operating for more than 5 minutes.

Do not set the security system alarm when someone is in the vehicle or a window is open. The system can accidentally activate when:

- Unlocking the door with the lock tab.
- Opening the bonnet with the bonnet release handle.

If the 12-volt battery goes dead after you have set the security system alarm, the security alarm may sound once the 12-volt battery is recharged or replaced. If this occurs, deactivate the security system alarm by unlocking a door using the remote transmitter or keyless access system.

If you unlock a door with the built-in key while the security system is activated, the alarm will sound.

## Security System Alarm Battery Information

Manufacturer Information:

FDK CORPORATION

Trade name: FDK

Postal address: Shibaura Crystal Shinagawa, 1-6-41 Konan, Minato-ku, Tokyo  
108-8212 Japan

Handling:

Do not short-circuit, disassemble, deform, heat or incinerate. Do not place battery on metal case, metal plate or antistatic material. In case of multi cell application, replace all batteries to new at once when replacing used batteries. Do not mix the different type of batteries, the new and old batteries of the same type, or the different manufacture of the same type batteries. Do not use batteries for unspecified purposes.

Storage:

Be sure to store batteries in well-ventilated, dry and cool conditions. Keep away from water, rain, snow, frost or dew condensation. Do not store batteries near source of heat or nozzle of hot air. Do not store batteries in direct sunshine. Take care not to get wet packing by dew condensation when packing is removed from cold to warm and humid condition. Enough number of fire fighting apparatuses should be installed in warehouse. Keep batteries out of reach of children.

Note: This content is based on the law and is subject to change without notice.

\* Not available on all models

### Security System Alarm

#### Right-hand Drive Type

The system may accidentally activate such as when:

- The vehicle is parked in an automated garage.
- The vehicle is being washed with highly pressurized water or being put through an automated car wash.
- The vehicle is being transported by train, ferry or trailer.
- The vehicle is subjected to heavy rain or stormy weather.
- Ice is being removed from the vehicle.

You can use ultrasonic/tilt sensor **OFF** button not to accidentally activate the security system alarm.

▶ **Ultrasonic Sensors\*** P. 216

▶ **Tilt Sensor\*** P. 217

## Ultrasonic Sensors\*

The ultrasonic sensors activate only when the security system alarm is set. If the sensors detect an intruder moving around inside or entering the interior of the vehicle through a window, the sensor will activate the alarm.

### ■ To set the security system alarm without activating the ultrasonic sensors

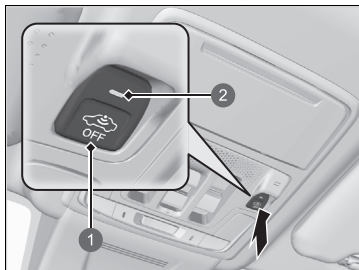

- 1 Ultrasonic/Tilt Sensor **OFF** Button
- 2 Indicator

You can set the security system without activating the ultrasonic sensor.

To turn off the ultrasonic sensor system, set the power mode to VEHICLE OFF by pressing the **POWER** button and then press the ultrasonic/tilt sensor **OFF** button.

▶ The indicator is on in red.

To turn it on again, press the ultrasonic/tilt sensor **OFF** button.

Ultrasonic sensors are turned on every time you set the security system alarm, even if you turned it off the last time.

### ▶ Ultrasonic Sensors\*

Whether the ultrasonic sensors have been activated or not, the security system can only be turned off by the remote transmitter or keyless access system, not the key.

It is possible to confirm whether the vehicle security system was activated without your knowledge. If the security system has been activated, the indicator will blink for 5 minutes after you unlock the door and disable the system.

If, however, you turn the power system on and transmission is changed other than [P], the indicator will stop blinking after 5 seconds.

If the ultrasonic sensor is malfunctioning or there is another problem, the indicator will come on for 5 minutes after you unlock the door and disable the system.

If, however, you turn the power system on and transmission is changed other than [P], the indicator will shut off.

The security system may accidentally activate by ultrasonic sensors such as when:

- Someone is in the vehicle
- A window is open
- Accessories or clothes are hanging in the vehicle

## Tilt Sensor\*

The tilt sensor activates only when the security system alarm is set. If someone raises the vehicle in an attempt to tow the vehicle or remove the wheels etc., the sensor will activate the alarm.

### ■ To set the security system alarm without activating the tilt sensor

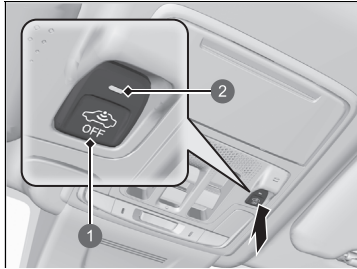

- 1 Ultrasonic/Tilt Sensor **OFF** Button
- 2 Indicator

You can set the security system without activating the tilt sensor.

To turn off the tilt sensor system, set the power mode to VEHICLE OFF by pressing the **POWER** button and then press the ultrasonic/tilt sensor **OFF** button.

▶ The indicator is on in red.

To turn it on again, press the ultrasonic/tilt sensor **OFF** button.

Tilt sensor is turned on every time you set the security system alarm, even if you turned it off the last time.

### ☒ Tilt Sensor\*

Whether the tilt sensor has been activated or not, the security system can only be turned off by the remote transmitter or keyless access system, not the key.

It is possible to confirm whether the vehicle security system was activated without your knowledge. If the security system has been activated, the indicator will blink for 5 minutes after you unlock the door and disable the system.

If, however, you turn the power system on and transmission is changed other than **[P]**, the indicator will stop blinking after 5 seconds.

If the tilt sensor is malfunctioning or there is another problem, the indicator will come on for 5 minutes after you unlock the door and disable the system.

If, however, you turn the power system on and transmission is changed other than **[P]**, the indicator will shut off.

Do not set the tilt sensor when the vehicle is lifted or jacked up.

\* Not available on all models

## Super Locking\*

The super locking function disables the lock tabs on all doors for better theft protection. Doors cannot be opened from the inside once super locking has been enabled.

### ■ Locking the doors without super locking when using a master door lock switch

1. Keep the driver's door closed.
2. Open the passenger door or rear door and push the master door lock switch in the lock direction.
3. Close the passenger door or rear door without touching the door handle.

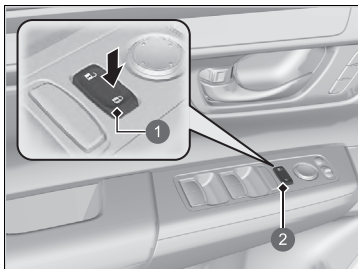

- 1 To Lock
- 2 Master Door Lock Switch

### ►► Super Locking\*

## ⚠ WARNING

No one must be inside the vehicle with the super locking set. Persons locked in can get seriously sick or die from the heat built inside the vehicle if left in the sun.

**Make sure there is no one inside the vehicle before setting the super locking.**

If you unlock a door with the built-in key while the security system is activated, the alarm will sound.

Once the super locking function has been enabled, it will remain enabled even if you unlock the tailgate.

## ■ Locking the doors without super locking when using the built-in key

The built-in key can be used to lock the doors without activating super locking even if you are not carrying the keyless remote.

1. With the driver's door open, pull out the door handle and lock the door with the built-in key.
2. Take out the built-in key and close the door while still pulling on the door handle.

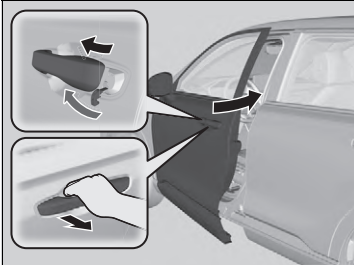

## Opening/Closing the Power Windows

The power windows can be opened and closed when the power mode is in ON, using the switches on the doors.

The driver's side switches can be used to open and close all the windows. The power window lock button on the driver's side must be switched off (not pushed in, indicator off) to open and close the windows from anywhere other than the driver's seat.

When the power window lock button is pushed in, the indicator comes on and you can only operate the driver's window. Turn the power window lock button on if a child is in the vehicle.

### Opening/Closing the Power Windows

#### **WARNING**

**Closing a power window on someone's hands or fingers can cause serious injury.**

**Make sure your passengers are away from the windows before closing them.**

**WARNING:** Always take the ignition key with you whenever you leave the vehicle alone or with other occupants.

The power windows can be operated for up to 10 minutes after you set the power mode to VEHICLE OFF. Closing driver's door cancels this function.

#### **Auto Reverse**

If a power window senses resistance when closing automatically, it will stop closing and reverse direction.

The driver's window auto reverse function is disabled when you continuously pull up the switch.

The auto reverse function stops sensing when the window is almost closed to ensure that it fully closes.

If the auto reverse function is activated due to a malfunction or impact caused by the road surface or driving conditions and the window cannot be closed automatically, you can close it by continuously pulling up the switch briefly.

## ■ Opening/Closing the Windows with Auto-Open/Close Function

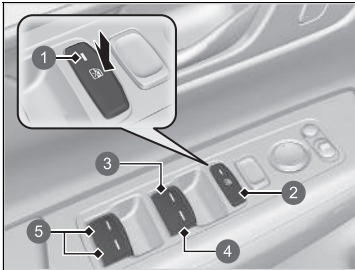

- ① Indicator
- ② Power Window Lock Button
- ③ Driver's Window Switch
- ④ Front Passenger's Window Switch
- ⑤ Rear Passenger's Window Switch

### ■ Manual operation

**To open:** Push the switch down lightly, and hold it until the desired position is reached.

**To close:** Pull the switch up lightly, and hold it until the desired position is reached.

### ■ Automatic operation

**To open:** Push the switch down firmly.

**To close:** Pull the switch up firmly.

The window opens or closes completely. To stop the window at any time, push or pull the switch briefly.

## ■ Opening/Closing the Windows with the Remote

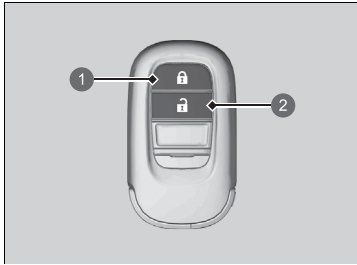

- ① Lock Button
- ② Unlock Button

**To open:** Press the unlock button, and then within 10 seconds, press it again and hold it.

**To close:** Press the lock button, and then within 10 seconds, press it again and hold it.

If the windows stop midway, repeat the procedure.

## ▣ Opening/Closing the Windows with the Remote

If you open/close the windows with the remote, the panoramic roof will open/close automatically along with them.

You can turn off or on to open the windows with the keyless remote setting using the audio/information screen.

- ▶ **How to Customize the Vehicle Settings**  
P. 368

## Opening/Closing the Panoramic Roof

You can operate the panoramic roof when the power mode is in ON. Use the switch in the front of the ceiling to open and close the panoramic roof.

### Opening/Closing the Panoramic Roof

#### **WARNING**

Opening or closing the panoramic roof or sunshade on someone's hands or fingers can cause serious injury.

Make sure all hands and fingers are clear of the panoramic roof and sunshade before opening or closing it.

**WARNING:** Always take the ignition key with you whenever you leave the vehicle alone or with other occupants.

#### **NOTICE**

Opening the panoramic roof in below freezing temperature or when it is covered with snow or ice can damage the panoramic roof panel or motor.

The panoramic roof can be operated for up to 10 minutes after you set the power mode to VEHICLE OFF. Closing driver's door cancels this function.

#### ☒ Opening/Closing the Panoramic Roof

When resistance is detected, the auto reverse function causes the panoramic roof to change directions, then stop. Auto reverse stops sensing when the panoramic roof is almost closed to ensure that it fully closes.

You can use the remote transmitter to operate the panoramic roof.

- ☒ **Opening/Closing the Windows with the Remote** P. 222

## ■ Using the Panoramic Roof Switch

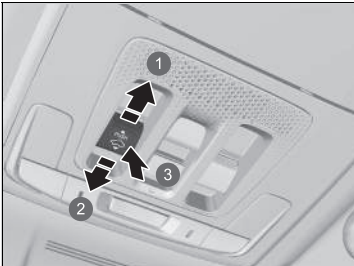

- ① Open
- ② Close
- ③ Tilt

### ■ Automatic operation

**To open:** Pull the switch back firmly.

**To close:** Push the switch forward firmly.

The panoramic roof automatically opens or closes all the way. To stop the panoramic roof midway, pull or push the switch briefly.

### ■ Manual operation

**To open:** Pull the switch back lightly, and hold it until the desired position is reached.

**To close:** Push the switch forward lightly, and hold it until the desired position is reached.

### ■ Tilting the panoramic roof up

**To tilt:** Push on the centre of the panoramic roof switch.

**To close:** Push the switch forward firmly.

## ☒ Using the Panoramic Roof Switch

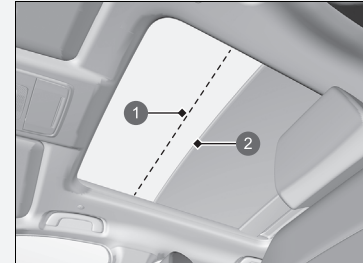

- ① Comfort Position
- ② Full Open Position

The panoramic roof cannot be fully opened in a single operation. The panoramic roof has a “comfort” position or wind noise reduction position at which the roof first stops.

To open fully, pull the switch back again after the roof has stopped at this position.

Whenever the panoramic roof is opening, the sunshade moves along with it. However, when the panoramic roof is closing, the sunshade does not move.

When you tilt open the panoramic roof, the sunshade opens slightly to let in fresh air. When you close the panoramic roof from this position, the sunshade returns to its closed position.

## ■ Using the Sunshade Switch

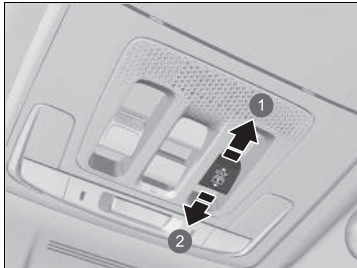

- ① Open
- ② Close

### ■ Automatic operation

**To open:** Pull the switch back firmly.

**To close:** Push the switch forward firmly.

The sunshade automatically opens or closes all the way. To stop the sunshade midway, pull or push the switch briefly.

### ■ Manual operation

**To open:** Pull the switch back lightly, and hold it until the desired position is reached.

**To close:** Push the switch forward lightly, and hold it until the desired position is reached.

## ☒ Using the Sunshade Switch

The sunshade can be opened or closed to adjust the amount of light that enters the cabin.

When you use the sunshade switch to open the sunshade, the panoramic roof does not move.

The sunshade cannot be fully closed if the panoramic roof is open. When you close the sunshade with the panoramic roof open, the sunshade stops slightly ahead of the panoramic roof glass. When you push the switch forward again, the sunshade and the panoramic roof close together.

## POWER Button

### ■ Changing the Power Mode

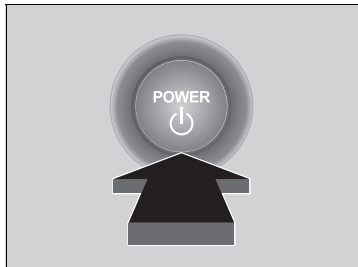

If you carry the keyless remote and press the **POWER** button without depressing the brake pedal, the power mode will change in this order: VEHICLE OFF→ACCESSORY→ON→VEHICLE OFF.

#### **VEHICLE OFF:**

Vehicle power is turned OFF.

#### **ACCESSORY:**

The audio system and some accessories can be used.

#### **ON:**

All accessories can be used.

### ■ Automatic Power Off

If you leave the vehicle for 30 to 60 minutes with the transmission in **[P]** and the power mode in ACCESSORY, the vehicle automatically goes into the mode similar to VEHICLE OFF to avoid draining the 12-volt battery.

### ■ Power Mode Reminder

If you open the driver's door when the power mode is in ACCESSORY, a warning beep sounds.

### ☒ POWER Button

If the keyless remote is set in a storage box or another place where its signal can be interrupted, the power mode may not change.

## ■ Keyless Remote Reminder



When the power mode is set to any mode other than OFF and you remove the keyless remote from the vehicle and shut the door, an alarm will sound. If the alarm continues to sound, place the keyless remote in another location.

### ■ When the power mode is in ACCESSORY

The alarm will sound from outside the vehicle.

### ■ When the power mode is in ON

An alarm will sound both inside and outside the vehicle. In addition, a warning indicator will appear on the instrument panel.

## ⊠ Keyless Remote Reminder

When the keyless remote is within the system's operational range, and all the doors are closed, the warning function cancels.

If the keyless remote is taken out of the vehicle after the power system has been turned on, you can no longer change the **POWER** button mode or restart the power system. Always make sure if the keyless remote is in your vehicle when you operate the **POWER** button.

Removing the keyless remote from the vehicle through a window does not activate the warning buzzer.

Do not put the keyless remote on the dashboard or in the glove box. It may cause the warning buzzer to sound. Under some other conditions that can prevent the vehicle from locating the keyless remote, the warning buzzer may also sound even if the keyless remote is within the system's operational range.

# Lights

## ■ Headlights/Position Lights

The lights will turn on automatically depending on the ambient brightness. They can also be switched on and off manually.

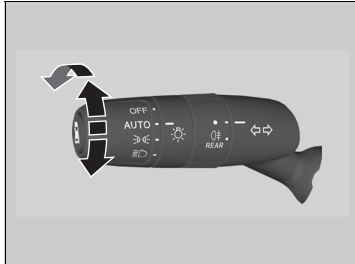

The exterior lights will switch on automatically when the light switch is set to **AUTO** while the power mode is in ON.

### ■ Manual operation

#### Headlights/position lights:

Turn the light switch to .

#### Position lights:

Turn the light switch to  until the position lights come on, then release.

#### Headlight/position lights off:

While the shift position is in **P** and the parking brake is applied, turn the light switch to **OFF** and then release once the lights turn off.

▶ The lights will come back on automatically when:

- The light switch is turned to **OFF** again and released.
- The transmission is changed out of **P** and the parking brake is released.

## ⌘ Lights

When the lights are on, the lights on indicator in the instrument panel will be on.



➤ **Lights On Indicator** P. 126

The headlights are suitable for only left-hand or only right-hand drive. When driving on roads with different traffic rules, the headlight beam must be adjusted.

➤ **Adjusting Headlight Distribution** P. 478

## ⌘ Headlights/Position Lights

When the position lights are on, the tail and rear licence plate lights will also switch on.

When the light switch is turned to  or  and the power is turned to OFF, a beeper sounds when the driver's door is opened.

When the light switch is in **AUTO** and the ambient light levels are low, the headlights and position lights will switch on if you unlock a door. They will switch off when the door is locked.

Your vehicle is equipped with the automatic headlight adjusting system that automatically adjusts the vertical angle of the low beam headlights. If you find a significant change in the vertical angle of the headlights, there may be a problem with the system. Have your vehicle checked by a dealer.

## ■ High Beams

When the headlights are on, push the lever forward. Pull the lever back to return to low beams.

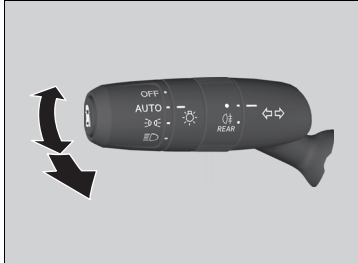

### ■ Flashing the high beams

Pull the lever back to switch on the high beams.

- ▶ Release the lever to return to low beams.

## ⌘ Headlights/Position Lights

The light sensor is in the location shown below. Do not cover the light sensor.

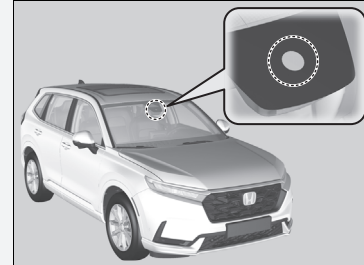

Do not leave the lights on when the power system is off because it will cause the 12-volt battery to discharge.

## ■ Turn Signals

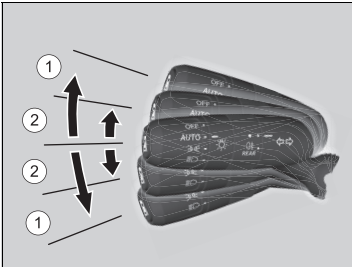

The turn signals can be used when the power mode is in ON.

### ■ ①: Turn signal

Push the lever up or down based on the direction you want to turn, and the turn signal will blink.

### ■ ②: One-touch turn signal

When you lightly push the lever up or down and release it, the turn signal will blink 3 times.

- ▶ If you lightly push the lever in the opposite direction while it is blinking, the blinking will stop.

## ☒ Turn Signals

The turn signal indicator on the instrument panel will blink when the external turn signal blinks.

### ☒ Turn Signal and Hazard Warning Indicators

P. 126

## ■ Headlight Integration with Wipers

The headlights automatically come on when the wipers are used several times within a certain number of intervals with the headlight switch in **AUTO**.

The headlights automatically go off a few minutes later if the wipers are stopped.

## ■ Automatic Lighting Off Feature

The headlights, all other exterior lights, and the instrument panel lights turn off 15 seconds after you set the power mode to VEHICLE OFF, take the keyless remote with you, and close the driver's door.

However, when the switch is in , the position lights remain on.

If you set the power mode to VEHICLE OFF with the headlight switch on, but do not open the door, the lights turn off after 10 minutes (3 minutes, if the switch is in the **AUTO** position).

The lights turn on again when you unlock or open the driver's door. If you unlock the door, but do not open it within 15 seconds, the lights go off. If you open the driver's door, you will hear a reminder chime alerting you that the lights are on.

### ⌘ Headlight Integration with Wipers

This feature activates while the headlights are off in **AUTO**. The instrument panel brightness does not change when the headlights come on.

At dark ambient light levels, the automatic lighting control feature turns on the headlights, regardless of the number of wiper sweeps.

You can turn the headlight integration with wipers function on and off.

➤ **How to Customize the Vehicle Settings**  
P. 368

### ⌘ Automatic Lighting Off Feature

You can change the headlight auto off timer setting.

➤ **How to Customize the Vehicle Settings**  
P. 368

## ■ Fog Light

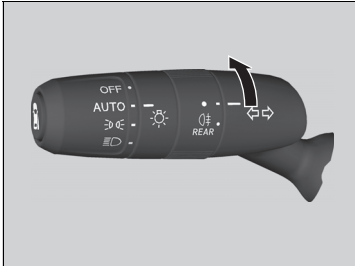

Can be used when the headlights are on.

## ■ Daytime Running Lights

The position/daytime running lights come on when the following conditions have been met:

- The power mode is in ON.
- The headlight switch is **AUTO** or .
- The ambient light is bright.

To turn off the daytime running lights, turn the light switch to **OFF** while the vehicle is stopped, and then release once the lights turn off. When the transmission is changed out of **P** and the parking brake is released, the lights will come on again. Otherwise, if the light switch is once more turned to **OFF**, the lights will come on again.

The tail lights will also come on when the daytime running lights are on.

## ▶▶ Daytime Running Lights

Daytime running lights and the position lights share the same light source.

Daytime running lights are brighter than the position lights.

## Active Cornering Lights\*

Enhance the visibility of the corner(s) when making a turn. With the power mode in ON, the headlights on, and the vehicle speed at less than 40 km/h (25 mph), the cornering light(s) comes on either when operating the turn signals or the steering wheel, or put the transmission into **[R]**.

■ **The corner you are making a turn towards is illuminated when:**

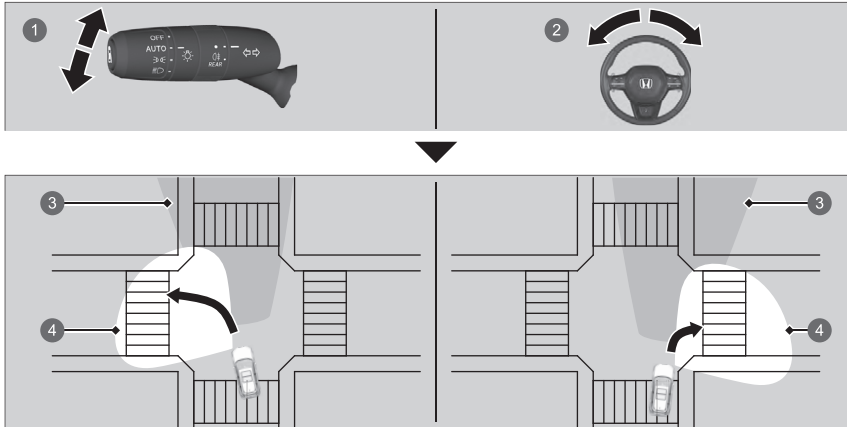

- 1 You operate the turn signal lever.
- 2 You turn the steering wheel around 75 degrees or more.
- 3 Headlight beam coverage
- 4 Cornering light beam coverage

### Active Cornering Lights\*

The active cornering lights go off automatically after five minutes. To resume the lights on, recreate the same condition; putting the turn signal lever or steering wheel in the centre position, then operate it again, or if the transmission has been in **[R]**, move it to another position momentarily.

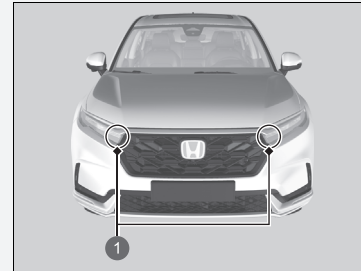

1 Active Cornering Lights

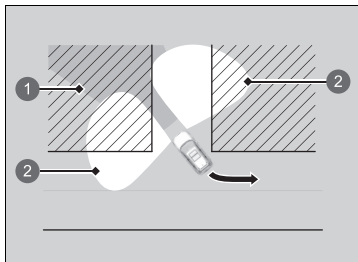

■ **Both front corners are illuminated when:**

You put the transmission into **R**.

- ① Headlight beam coverage
- ② Cornering light beam coverage

## Headlight Adjuster\*

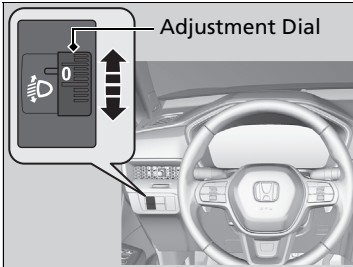

You can adjust the vertical angle of the low beam headlights when the position lights or headlights are on.

Turn the adjustment dial to select an appropriate angle for the headlights.

The larger dial number indicates the lower angle.

### ■ To select the adjustment dial position

Refer to the below table for the appropriate dial position for your vehicle's riding and loading conditions.

Condition	Dial position
A driver	0
A driver and a front passenger	0
Five persons in the front and rear seats	1
Five persons in the front and rear seats and luggage in the luggage area, within the limits of maximum permissible axle weight and maximum permissible vehicle weight	2
A driver and luggage in the luggage area, within the limits of maximum permissible axle weight and maximum permissible vehicle weight	3

### ⊞ Headlight Adjuster\*

#### Models without adjustment dial

Your vehicle is equipped with the automatic headlight adjusting system that automatically adjusts the vertical angle of the low beam headlights. If you find a significant change in the vertical angle of the headlights, there may be a problem with the system. Have your vehicle checked by a dealer.

\* Not available on all models

## Adaptive Driving Beam\*

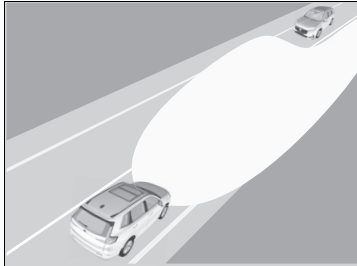

When driving at night, the front sensor camera detects light sources such as street lights or the lights of an oncoming or preceding vehicle. The system automatically switches the headlights between low and high beam depending on the situation.

In addition, the system automatically adjusts the light distribution of the high beams in order to reduce glare for preceding and oncoming vehicles.

The system also increases the coverage of the low beams when the low beams are on and the vehicle speed is 40 km/h (25 mph) or less, improving visibility to the left and right.

### ▶ Adaptive Driving Beam\*

The adaptive driving beam system does not always operate in every situation. This system is just for assisting the driver. Always observe your surroundings and switch the headlights between high beam and low beam manually if necessary.

The range and the distance at which the camera can recognise varies depending on conditions surrounding your vehicle.

Regarding the handling of the camera mounted to the inside of the windscreen, refer to the following.

#### ▶ Front Sensor Camera P. 585

For the adaptive driving beam to work properly:

- Do not place an object that reflects light on the dashboard.
- Keep the windscreen around the camera clean.
- When cleaning the windscreen, be careful not to apply the windscreen cleanser to the camera lens.
- Do not attach an object, sticker, or film to the area around the camera.
- Do not touch the camera lens.

If the camera receives a strong impact, or repairing of the area near the camera is required, consult a dealer.

## How to Use the Adaptive Driving Beam

### Activating the system

The adaptive driving beam indicator comes on, and the system begins adjusting the light distribution of the high beams when all of the following conditions are met.

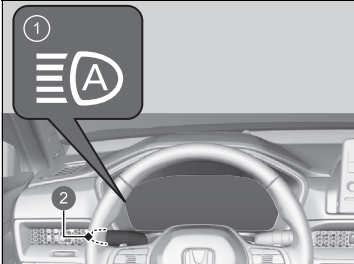

- 1 Adaptive Driving Beam Indicator
- 2 Light Switch

- The power mode is in ON.
- The light switch is in **AUTO**.
- The lever is in the low beam position.
- The headlights have been automatically activated.
- It is dark outside the vehicle.

If the adaptive driving beam indicator does not come on even when all the conditions have been met, carry out either of the procedures below and the indicator will come on.

- Pull the lever towards you and release it.
- Turn the light switch to  then turn the light switch to **AUTO**.

### Adaptive Driving Beam\*

In the following cases, the adaptive driving beam system may not switch the headlights properly or the switching timing may be changed. In case of the automatic switching operation does not fit for your driving habits, please switch the headlights manually.

- The brightness of the lights from the preceding or oncoming vehicle is intense or poor.
- Visibility is poor due to the weather (rain, snow, fog, windscreen frost, etc.).
- Surrounding light sources, such as street lights, electric billboards, and traffic lights are illuminating the road ahead.
- The brightness level of the road ahead constantly changes.
- The road is bumpy or has many curves.
- A vehicle suddenly appears in front of you, or a vehicle in front of you is not in the preceding or oncoming direction.
- Your vehicle is tilted with a heavy load in the rear.
- A traffic sign, mirror, or other reflective object ahead is reflecting strong light toward the vehicle.
- The oncoming vehicle frequently disappears under roadside trees or behind median barriers.
- The preceding or oncoming vehicle is a motorcycle, bicycle, mobility scooter, or other small vehicle.

The adaptive driving beam system keeps the headlight low beam when:

- Windscreen wipers are operating at a high speed.
- The camera has detected a dense fog.

#### How to turn off the Adaptive Driving Beam System

You can turn the adaptive driving beam system on and off.

#### ▶ How to Customize the Vehicle Settings

P. 368

\* Not available on all models

### ■ Automatically adjusting the light distribution

The system starts to automatically adjust the light distribution of the high beams once the vehicle speed is 40 km/h (25 mph) or higher, and the light distribution changes depending on vehicle speed, or under the following conditions:

- There is a preceding or oncoming vehicle with headlights or taillights turned on.
- There are many street lights on the road ahead.

If the vehicle speed slows to 24 km/h (15 mph) or lower, the system stops automatically adjusting the light distribution and switches the headlights to low beam.

### ■ Manual switching between high-beam and low-beam

If you want to manually switch the headlights between high beam and low beam, follow the procedure below. Note that when you do this, the adaptive driving beam indicator will turn off and the adaptive driving beam will be deactivated.

#### Using the lever:

Pull the lever towards you for flashing the high beams then release it or push the lever forward to the high beam position.

- ▶ To reactivate the adaptive driving beam, follow either of the procedures below and the adaptive driving beam indicator will come on.
- Pull the lever towards you and release it.
- Turn the light switch to  and then to **AUTO** when the lever is in the low beam position.

#### Using the light switch:

Turn the light switch to .

- ▶ To reactivate the adaptive driving beam turn the light switch to **AUTO** when the lever is in the low beam position, the adaptive driving beam indicator will come on.

## Wipers and Washers

### ■ Windscreen Wipers/Washers

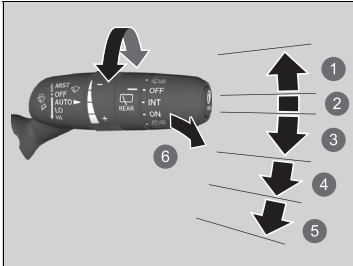

- ① **MIST**
- ② **OFF**
- ③ **AUTO**
- ④ **LO**: Low speed wipe
- ⑤ **HI**: High speed wipe
- ⑥ **Washer**

The windscreen wipers and washers can be used when the power mode is in ON.

#### ■ **MIST**

The wipers run at high speed until you release the lever.

#### ■ **Wiper switch (OFF, AUTO, LO, HI)**

Move the lever up or down to change the wiper settings.

#### ■ **Washer**

Sprays while you pull the lever toward you. When you release the lever for more than one second, the spray stops, the wipers sweep two or three more times to clear the windscreen, then stop.

### ▶▶ Wipers and Washers

#### NOTICE

Do not use the wipers when the windscreen is dry. The windscreen will get scratched, or the rubber blades will get damaged.

The wiper motor may stop motor operation temporarily to prevent an overload. Wiper operation will return to normal within a few minutes.

#### NOTICE

Turn the washers off if no washer fluid comes out. The pump may get damaged.

#### NOTICE

In cold weather, the blades may freeze to the windscreen.

Operating the wipers in this condition may damage the wipers. Use the demister to warm the windscreen, then turn the wipers on.

If the wipers stop operating due to an obstacle such as the buildup of snow, park the vehicle in a safe place. Rotate the wiper switch to **OFF**, and set the power mode to ACCESSORY or VEHICLE OFF, then remove the obstacle.

## ■ Automatic Intermittent Wipers

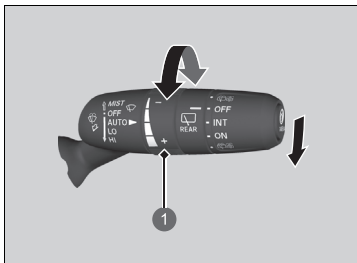

- 1 Adjustment Ring  
-: Low Sensitivity  
+: High Sensitivity

When you push the lever down to **AUTO**, the windscreen wipers sweep once, and go into the automatic mode.

The wipers operate intermittently, at low speed, or at high speed and stop in accordance with the amount of rainfall the rainfall sensor detects.

### ■ **AUTO** sensitivity adjustment

When the wiper function is set to **AUTO**, you can adjust the sensitivity of the rainfall sensor (using the adjustment ring) so that wipers will operate in accordance with your preference.

## ▶▶ Automatic Intermittent Wipers

The rainfall sensor is in the location shown below.

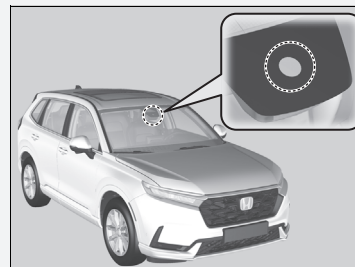

### **NOTICE**

**AUTO** should always be turned **OFF** before the following situations in order to prevent severe damage to the wiper system:

- Cleaning the windscreen
- Driving through a car wash
- No rain present

## ■ Rear Wiper/Washer

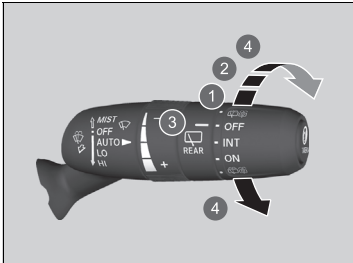

The rear wiper and washer can be used when the power mode is in ON.

### ■ Wiper switch (OFF, INT, ON)

Change the wiper switch setting according to the amount of rain.

### ■ Washer (☐, ☐)

Sprays on the rear window and rearview camera while you rotate the switch to this position.

Hold it to activate the rear wiper and to spray the washer. Once released, the washer spray will stop and the rear wiper will return to its selected switch setting after a few sweeps.

- 1 INT: Intermittent
- 2 ON: Continuous wipe
- 3 OFF
- 4 Washer

### ■ Operating in reverse

When you put the transmission into **R** with the windscreen wipers activated, the rear wiper operates automatically as follows even if its switch is off.

Front Wiper Operation	Rear Wiper Operation
Intermittent	Intermittent
Low speed wipe High speed wipe	Continuous

## Rear Demister/Heated Door Mirror Button

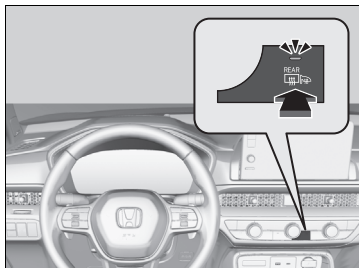

Press the rear demister and heated door mirror button to demist the rear window and mirrors when the power mode is in ON.

The rear demister and heated door mirror automatically switches off after 10-30 minutes depending on the outside temperature. However, if the outside temperature is 0°C or below, it does not automatically switch off.

### ⚡ Rear Demister/Heated Door Mirror Button

This system consumes a lot of power, so turn it off when the window has been demisted. Also, do not use the system for a long time while the power system is stopped. This may weaken the 12-volt battery, making it difficult to turn the power system on.

When the power mode is set to ON and the outside temperature is below 5°C, the heated door mirror may automatically activate for 10 minutes.

## Driving Position Memory System\*

You can store two driver's seat positions (except for power lumbar) with the driving position memory system.

When you unlock and open the driver's door with a keyless remote or keyless access system, the seat adjusts automatically to one of the two preset positions.

- **DRIVER 1** transmitter is linked to memory button 1.
- **DRIVER 2** transmitter is linked to memory button 2.



- ① **DRIVER 1**
- ② **DRIVER 2**

The driver's seat moves rearward depending on the set seating position once you

- Stop the vehicle.
- Put the transmission in **P**.
- Set the power mode to VEHICLE OFF.
- Open the driver's door.

Once the power mode is in the ACCESSORY position, the driver's seat moves forward to the **DRIVER 1** or **2** preset position.

### ⊗ Driving Position Memory System\*

Using the audio/information screen, you can disable the automatic seat adjustment function.

- **How to Customize the Vehicle Settings**  
P. 368

The driver's seat easy exit feature can be turned ON/OFF.

- **How to Customize the Vehicle Settings**  
P. 368

### System Operation

The system will not operate if:

- The transmission is out of the **P** position.
- Either memory button is pressed while the seat is in motion.
- The seat position is adjusted while in operation.
- Either of the memorized positions is set fully to the rear.

The system may not recognise a key if:

- The key is in close proximity to a mobile phone or other wireless device.
- Both keys are in the vehicle at the same time.
- The Driving Position Memory System is disabled in customized features.
- Opening driver's door without fully grabbing the door handle.

## ■ Storing a Position in Memory

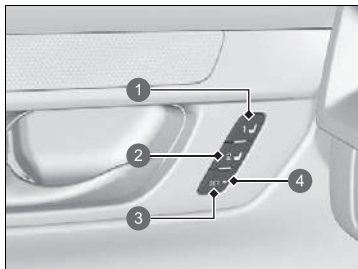

- ① Memory Button 1
- ② Memory Button 2
- ③ SET Button
- ④ Indicator Light

1. Set the power mode to ON. Adjust the driver's seat to the desired position.
2. Press the **SET** button.
  - ▶ The **SET** button indicator light will come on.
3. Press and hold memory button **1** or **2** within five seconds of pressing the **SET** button.
  - ▶ You will hear the beeper, and the **SET** button indicator light goes off.

## ■ Recalling the Stored Position

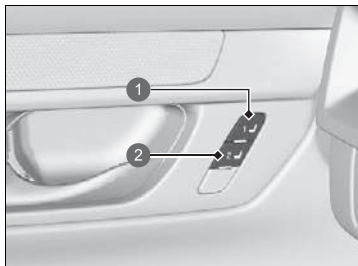

- ① Memory Button 1
- ② Memory Button 2

1. Put the transmission into **P**.
2. Apply the parking brake.
3. Press a memory button (**1** or **2**).

The seat will automatically move to the memorized position.

## ▣ Storing a Position in Memory

After you press the **SET** button, the storing operation will be cancelled when:

- You do not press the memory button within five seconds.
- You readjust the seat position before the double-beep.
- You set the power mode to any position except ON.

## ▣ Recalling the Stored Position

The seat will stop moving if you:

- Press the **SET** button, or a memory button (**1** or **2**).
- Adjust the seat position.
- Put the transmission to a position other than **P**.

## Adjusting the Steering Wheel

The steering wheel height and distance from your body can be adjusted so that you can comfortably grip the steering wheel in an appropriate driving posture.

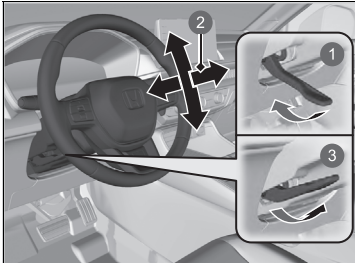

- 1 Release
- 2 Adjust
- 3 Lock

1. While the vehicle is stopped, push the steering wheel adjustment lever down.
  - ▶ The steering wheel adjustment lever is under the steering column.
2. Move the steering wheel up or down, and in or out.
  - ▶ Make sure you can see the instrument panel gauges and indicators.
3. Pull the steering wheel adjustment lever up to lock the steering wheel in position.
  - ▶ After adjusting the position, make sure you have securely locked the steering wheel in place by trying to move it up, down, in, and out.

### Adjusting the Steering Wheel

#### **⚠ WARNING**

Adjusting the steering wheel position while driving may cause you to lose control of the vehicle and be seriously injured in a crash.

Adjust the steering wheel only when the vehicle is stopped.

## Interior Rearview Mirror

Adjust the angle of the rearview mirror when you are sitting in the correct driving position.

### » Mirrors

Keep the inside and outside mirrors clean and adjusted for best visibility.

Adjust the mirrors before you start driving.

➔ **Front Seats** P. 251

### » Automatic Dimming Rearview Mirror

The auto dimming function cancels when the transmission is in **[R]**.

## ■ Automatic Dimming Rearview Mirror

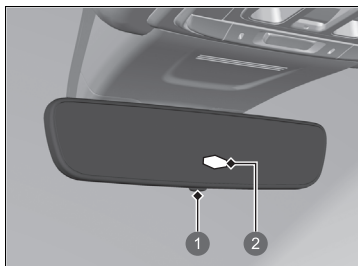

When you are driving after dark, the automatic dimming rearview mirror reduces the glare from headlights behind you. Press the AUTO button to turn this function on and off. When activated, the AUTO indicator comes on.

- 1 Auto Button
- 2 Sensor

## Power Door Mirrors

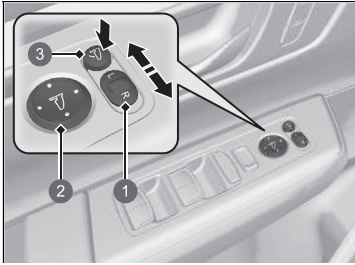

- 1 Selector Switch
- 2 Adjustment Switch
- 3 Folding Button

You can adjust the door mirrors when the power mode is in ON.

### ■ Mirror position adjustment

**L/R selector switch:** Select the left or right mirror. After adjusting the mirror, return the switch to the centre position.

**Mirror position adjustment switch:** Press the switch left, right, up, or down to move the mirror.

### ■ Folding door mirrors

Press the folding button to fold in and out the door mirrors.

### ■ Reverse Tilt Door Mirror

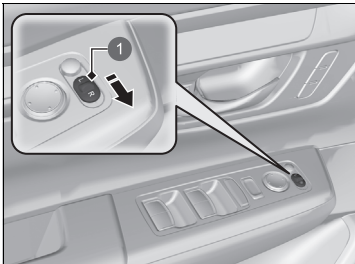

- 1 Selector Switch

If activated, the passenger side door mirror automatically tilts downward when you put the transmission into **[R]**; this improves close-in visibility on the passenger side of the vehicle when backing up. The mirror automatically returns to its original position when you take the transmission out of **[R]**.

To activate this feature, set the power mode to ON, and slide the selector switch to the passenger's side.

## ■ Automatic Folding Door Mirror Function

### ■ Folding in the door mirrors

Press the lock button on the keyless remote or the tailgate, or touch the door lock sensor on the either front door.

- ▶ The mirrors start folding in automatically.

### ■ Folding out the door mirrors

Press the unlock button on the keyless remote, or grab the door handle on the either front door.

- ▶ The mirrors start folding out automatically.

## ⌘ Automatic Folding Door Mirror Function

You cannot turn the automatic folding out automatically if they have been folded in using the folding button.

You can turn the automatic folding door mirror function on and off.

### ⌘ How to Customize the Vehicle Settings

P. 368

Door mirrors will not fold automatically when locking from inside the vehicle using lock tab or master door lock switch.

## Front Seats

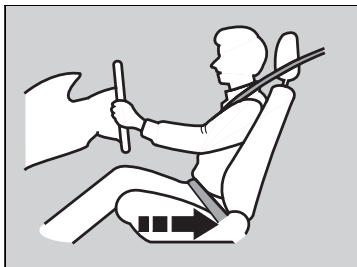

Move back to allow sufficient space.

Adjust the driver's seat as far back as possible while allowing you to maintain full control of the vehicle. You should be able to sit upright, well back in the seat and be able to adequately press the pedals without leaning forward, and grip the steering wheel comfortably. The passenger's seat should be adjusted in a similar manner, so that it is as far back from the front airbag in the dashboard as possible.

### Seats

Always make seat adjustments before driving.

### Front Seats

## **⚠ WARNING**

Sitting too close to a front airbag can result in serious injury or death if the front airbags inflate.

Always sit as far back from the front airbags as possible while maintaining control of the vehicle.

In addition to the seat adjustment, you can adjust the steering wheel up and down, in and out. Allow at least 25 cm (10 inches) between the centre of the steering wheel and the chest.

## ■ Adjusting the Seat Positions

### ■ Adjusting the front power seats



- ① Horizontal Position Adjustment
- ② Height Adjustment (Driver's seat only)
- ③ Seat-back Angle Adjustment

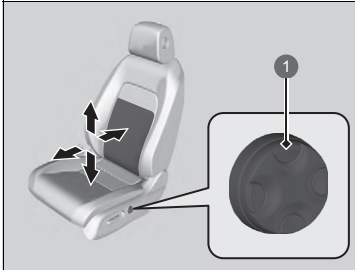

1 Lumbar Support Adjustment Switch

### ■ Lumbar support adjustment switch

**Press the top:** To move the lumbar support up.

**Press the bottom:** To move the lumbar support down.

**Press the front:** To increase the entire lumbar support.

**Press the rear:** To decrease the entire lumbar support.

## ■ Adjusting the Seat-Backs

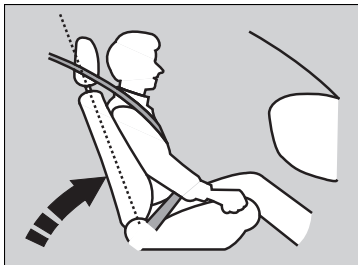

Adjust the driver's seat-back to a comfortable, upright position, leaving ample space between your chest and the airbag cover in the centre of the steering wheel.

The front seat passenger should also adjust their seat-back to a comfortable, upright position.

Reclining a seat-back so that the shoulder part of the belt no longer rests against the occupant's chest reduces the protective capability of the belt. It also increases the chance of sliding under the belt in a crash and being seriously injured. The farther a seat-back is reclined, the greater the risk of injury.

## ►► Adjusting the Seat-Backs

### **⚠ WARNING**

**Reclining the seat-back too far can result in serious injury or death in a crash.**

**Adjust the seat-back to an upright position, and sit well back in the seat.**

Do not put a cushion, or other object, between the seat-back and your back.

Doing so may interfere with proper seat belt or airbag operation.

If you cannot get far enough away from the steering wheel and still reach the controls, we recommend that you investigate whether some type of adaptive equipment may help.

## Rear Seats

### ■ Adjusting the Seat Positions

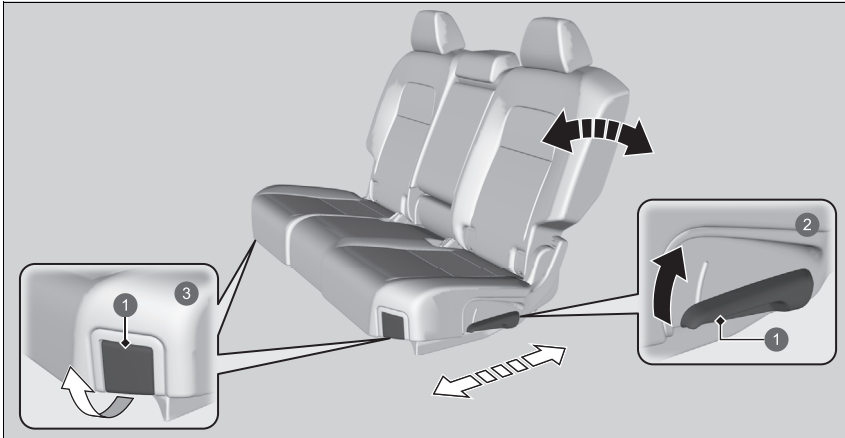

- ① Lever
- ② **Seat-back Angle Adjustment**  
Pull up the lever to change the angle.
- ③ **Horizontal Position Adjustment**  
Pull up on the lever to move the seat, then release the lever.

### ⊞ Rear Seats

## ⚠ WARNING

An unsecured seat or seat-back can move out of position or collapse without warning if there is sudden acceleration or stop or in a crash.

A seat or seat-back that suddenly moves or collapses can result in severe injury or death.

Always make sure all seats and seat-backs are securely locked into position before driving.

Once a seat is adjusted correctly, rock it back and forth to make sure it is locked in position.

## ■ Folding Down the Rear Seats

The rear seats can be folded down separately to allow for additional storage space.

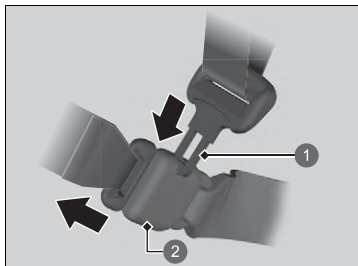

- 1 Latch Plate
- 2 Anchorage Buckle

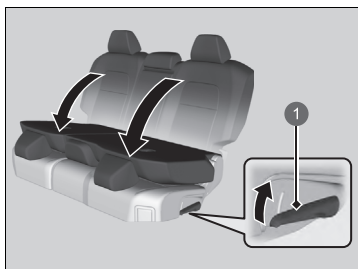

- 1 Release Lever

1. Store the centre seat belt first. Insert the latch plate into the slot on the side of the anchorage buckle.
2. Retract the seat belt into the holder on the ceiling.
  - ▣ **Seat Belt with Detachable Anchorage**  
P. 57
3. Lower the rear seat head restraint to its lowest position. Put the armrest back into the seat-back.
4. Pull the release lever and fold down the seat.

To return the seat to the original position, pull up the seat-back in the upright position.

## ▣ Folding Down the Rear Seats

### **⚠ WARNING**

**Make sure the seat-backs are latched securely before driving.**

The rear seat-backs can be folded down to accommodate bulkier items in the luggage area.

Remove any items from the rear seat cushion and floor before you fold down the rear seat.

The front seats must be far enough forward so they do not interfere with the rear seats as they fold down.

When returning the seat-back to its original position, push it firmly back. Also, make sure all rear shoulder belts are positioned in front of the seat-back.

**Make sure all items in the luggage area or items extending through the opening into the rear seats are properly secured. Loose items can fly forward if you have to brake hard.**

## Rear Seat Reminder

This feature alerts you of the possible presence of passengers or items in the rear seats before you exit the vehicle. It activates when the vehicle is set to VEHICLE OFF if the rear doors were opened shortly before or after the vehicle was set to ON.

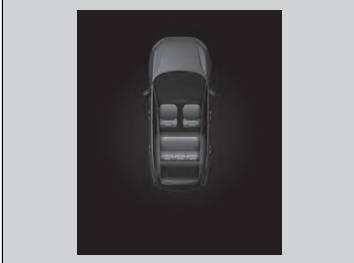

A reminder appears on the driver information interface and an alert will sound when the power mode is set to VEHICLE OFF.

### ⌘ Rear Seat Reminder

When the power mode is set to VEHICLE OFF, the reminder comes on briefly, then the function is deactivated.

The reminder will not work if the power mode has not been set to ON within 10 minutes of operating the rear doors.

The system does not detect passengers in the rear seats. Instead, it can detect when a rear door is opened and closed, indicating that there may be something in the rear seats.

You can turn off the notification setting.

#### ⌘ **How to Customize the Vehicle Settings**

P. 368

## Maintain a Proper Sitting Position

After all occupants have adjusted their seats and head restraints, and put on their seat belts, it is very important that they continue to sit upright, well back in their seats, with their feet on the floor, until the vehicle is safely parked and the power mode is off.

Sitting improperly can increase the chance of injury during a crash. For example, if an occupant slouches, lies down, turns sideways, sits forward, leans forward or sideways, or puts one or both feet up, the chance of injury during a crash is greatly increased.

In addition, an occupant who is out of position in the front seat can be seriously or fatally injured in a crash by striking interior parts of the vehicle or being struck by an inflating front airbag.

### ►► Maintain a Proper Sitting Position

#### **WARNING**

**Sitting improperly or out of position can result in serious injury or death in a crash.**

**Always sit upright, well back in the seat, with your feet on the floor.**

## Head Restraints

Your vehicle is equipped with head restraints in all seating positions.

### ■ Adjusting the Front Head Restraint Positions

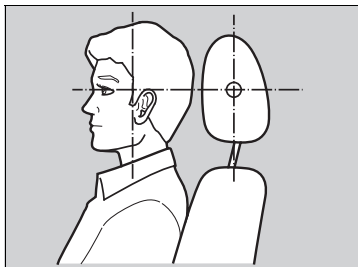

Head restraints are most effective for protection against whiplash and other rear-impact crash injuries when the centre of the back of the occupant's head rests against the centre of the restraint. The tops of the occupant's ears should be level with the centre height of the restraint.

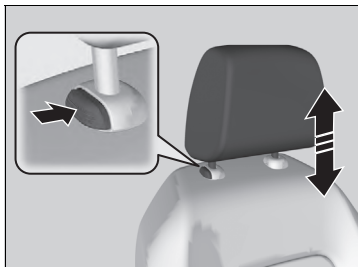

**To raise the head restraint:**

Pull it upward.

**To lower the head restraint:**

Push it down while pressing the release button.

#### ▣ Head Restraints

### ⚠ WARNING

Improperly positioning head restraints reduces their effectiveness and increases the likelihood of serious injury in a crash.

**Make sure head restraints are in place and positioned properly before driving.**

In order for the head restraint system to work properly:

- Do not hang any items on the head restraints, or from the restraint legs.
- Do not place any objects between an occupant and the seat-back.
- Install each restraint in its proper location.

The front seat head restraints cannot be removed.

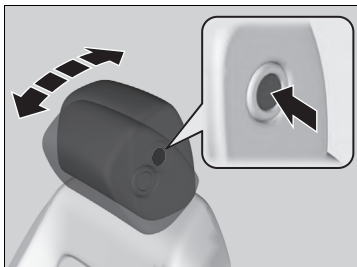

The front head restraint tilt can be adjusted according to you and a front passenger's head positions.

**To tilt forward:** Push the head restraint forward.

**To return to the original position:** Press the release button.

### ■ Changing the Rear Seat Head Restraint Positions

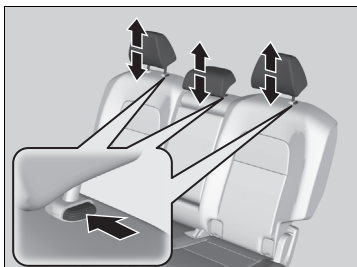

A passenger sitting in the rear seat should adjust the height of their head restraint to an appropriate position before the vehicle begins moving.

**To raise the head restraint:**

Pull it upward.

**To lower the head restraint:**

Push it down while pressing the release button.

### ▣ Changing the Rear Seat Head Restraint Positions

When you use the head restraint in the rear centre seating position, pull up the head restraint to its highest position. Do not use it in any lower position.

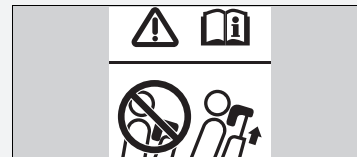

## Removing and Reinstalling the Rear Seat Head Restraints

Head restraints can be removed for cleaning or repair.

### To remove a head restraint:

#### Centre seat head restraint

Pull the restraint up as far as it will go. Then, push the release button and pull the restraint up and out.

#### Outer seat head restraint

Pull the restraint up as far as it will go. Then push the release buttons located on both legs at the same time, and pull the restraint up and out.

### To reinstall a head restraint:

Insert the legs back in place, then adjust the head restraint to an appropriate height while pressing the release button. Pull up on the restraint to make sure it is locked in position.

#### Removing and Reinstalling the Rear Seat Head Restraints

### ⚠ WARNING

Failure to reinstall or correctly reinstall, the head restraints can result in severe injury during a crash.

Always replace the head restraints before driving.

## Armrest

### ■ Using the Front Seat Armrest

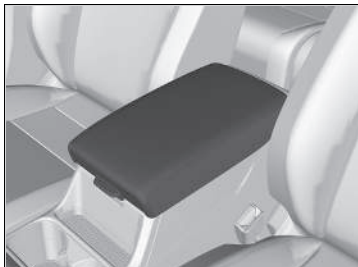

The console lid can be used as an armrest.

### ■ Using the Rear Seat Armrest



Pull down the armrest in the centre seat-back.

## Interior Lights

### Interior Light Switches

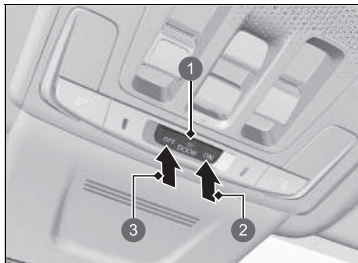

1 Door Activated Position

2 ON

3 OFF

#### ON

The interior lights come on regardless of whether the doors are open or closed.

#### Door activated

The interior lights come on in the following situations:

- When any doors are opened.
- You unlock the driver's door.
- When the power mode is set to VEHICLE OFF.

#### OFF

The interior lights remain off regardless of whether the doors are open or closed.

### Interior Light Switches

In the door activated position, the interior lights fade out and go off about 30 seconds after the doors are closed.

The lights go off after about 30 seconds in the following situations:

- When you unlock the driver's door but do not open it.
- When you set the power mode to VEHICLE OFF but do not open a door.

You can change the interior lights dimming time.

#### How to Customize the Vehicle Settings

P. 368

The interior lights go off immediately in the following situations:

- When you lock the driver's door.
- When you close the driver's door in ACCESSORY mode.
- When you set the power mode to ON.

If you leave any of the doors open in VEHICLE OFF mode, the interior lights go off after about 15 minutes.

To avoid draining the 12-volt battery, do not leave the interior light on for an extended length of time when the power system is off.

## ■ Map Light Switches

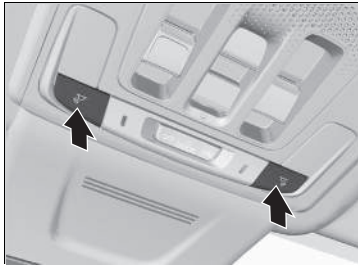

### ■ Front seat

The map lights can be turned on and off by pressing the buttons.

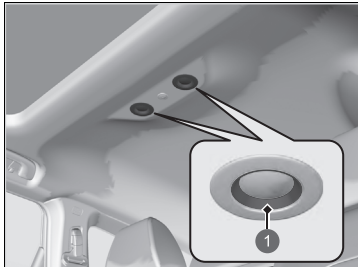

### ■ Rear seat

The map lights can be turned on and off by touching the map lights.

1 Touch

## » Map Light Switches

When the front interior light switch is in the door activated position and any door is open, the map light will not go off when you press the buttons or touch the map lights.

## ■ Luggage Area Lights

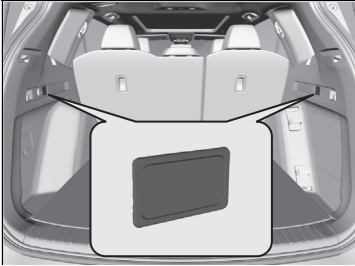

The luggage area lights come on when you open the tailgate.

## Storage Items

### ■ Glove Box

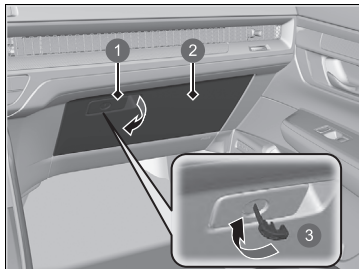

- ① Handle
- ② Glove Box
- ③ To Lock

Pull the handle to open the glove box.

You can lock the glove box with the built-in key.

### » Glove Box

#### **⚠ WARNING**

An open glove box can cause serious injury to your passenger in a crash, even if the passenger is wearing the seat belt.

Always keep the glove box closed while driving.

## ■ Console Compartment



Pull the handle to open the console compartment.

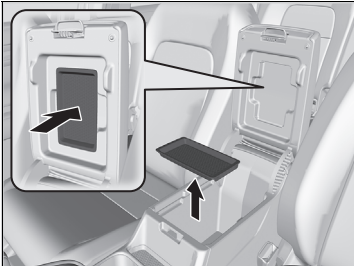

### ■ Removable tray

The tray can be removed and stored on the bottom surface of the armrest.

## ■ Beverage Holders



### ■ Front seat beverage holders

Located in the console between the front seats.

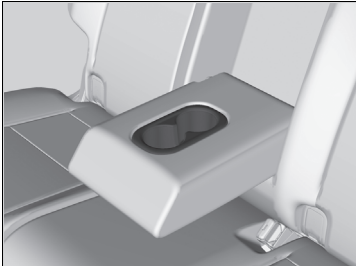

### ■ Rear seat beverage holders

Fold the armrest down to use the rear seat beverage holders.

## » Beverage Holders

### NOTICE

Spilled liquids can damage the upholstery, carpeting, and electrical components in the interior.

Be careful when you are using the beverage holders. Hot liquid can scald you.

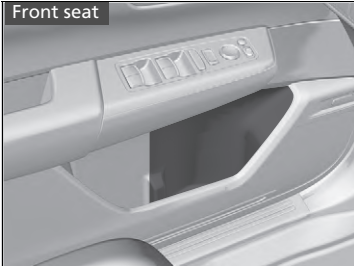

### ■ Door beverage holders

Located on both of front and rear door side pockets.

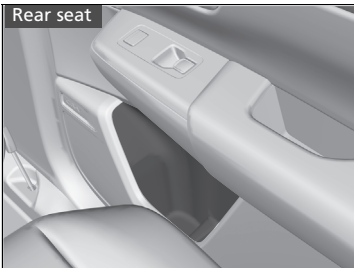

### ■ Coat Hooks



There are coat hooks on the rear left and right grab handles.

### ☒ Coat Hooks

The coat hooks are not designed for large or heavy items.

## ■ Tie-down Anchorages

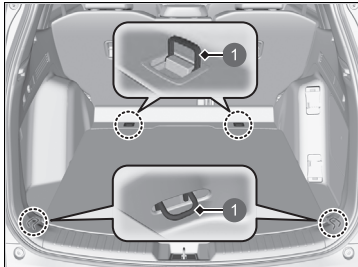

1 Anchorages

The tie-down anchorages on the luggage area floor can be used to install a net for securing items.

## ■ Luggage Hooks

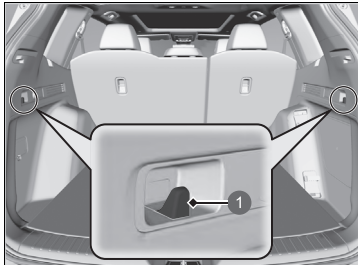

1 Hook

The luggage hooks in the luggage area can be used to hang a light items.

## » Tie-down Anchorages

Do not let anyone access items in the luggage area while driving. Loose items can cause injury if you have to brake hard.

## » Luggage Hooks

### NOTICE

Do not hang a large object or an object that weighs more than 3 kg (6 lbs) on the side luggage hooks. Hanging heavy or large objects may damage the hooks.

## ■ Sunglasses Holder



1 Press



To open the sunglasses holder, press and release the indent. To close, press it again until it latches.

You can store eyeglasses and other small items in this holder.

### ■ Conversation mirror

The sunglasses holder comes with a mirror. Open the sunglasses holder fully, then push it back to the first detent.

You can use the mirror to view the rear seats.

## ☒ Sunglasses Holder

Keep the holder closed while driving except when accessing stored items.

## ■ Luggage Storage Area

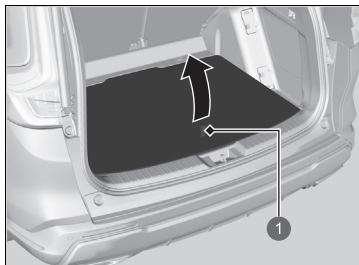

1 Strap

### ■ Storing items on the lid (lowered position)

This is convenient when storing a tall item.

1. Pull the strap to open the luggage floor lid.

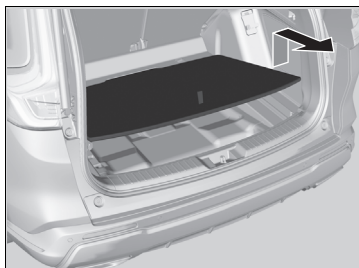

2. Pull the strap upwards to lift the floor lid.

3. Pull the floor lid towards you until it disengages from the support rods.

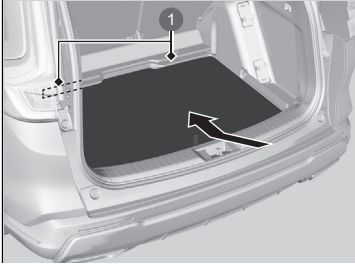

1 Support Rod

4. Push the far end of the floor lid down to the bottom under the support rods, then lower the other end.

## ■ Luggage Area Cover

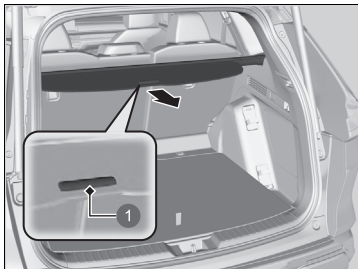

1 Handle

The luggage area cover can be used to conceal items in the luggage area and protect them from direct sunlight.

### ■ To extend:

Slightly lift up on the handle at the centre edge of the cover to unhook each end, then pull the cover rearward and clip the mounting rods in the hooks at both sides of the tailgate opening.

### ■ To retract:

Slip the rods out of the hooks, then slowly roll it back until it is completely retracted.

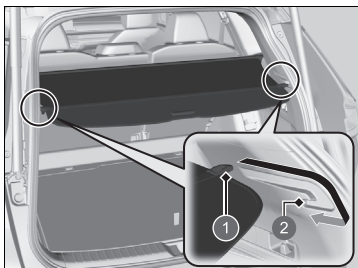

1 Mounting Rod

2 Hook

## ▣ Luggage Area Cover

Do not let anyone access items in the luggage area while driving. Loose items can cause injury if you have to brake hard.

Do not stack objects higher than the top of the seat in the luggage area. They could block your view and be thrown about the vehicle during a sudden stop.

To prevent luggage area cover damage:

- Do not place items on the luggage area cover.
- Do not put weight on the luggage area cover.

Be sure that each mounting rod sets in its respective retention groove when you retract the rear luggage cover. If they are not set in the grooves, the rods may rattle as they contact the surrounding surfaces.

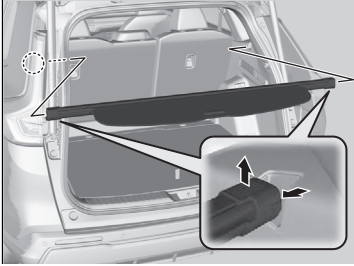

■ **To remove:**

Push either end of the housing inward, then lift it out of its position.

## Other Interior Convenience Items

### ■ Accessory Power Sockets

The accessory power sockets can be used when the power mode is in ACCESSORY or ON.

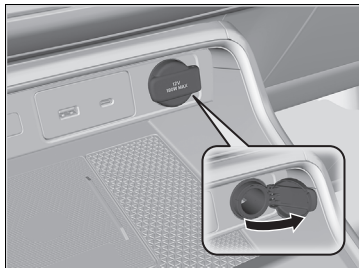

#### ■ Console panel

Open the cover to use it.

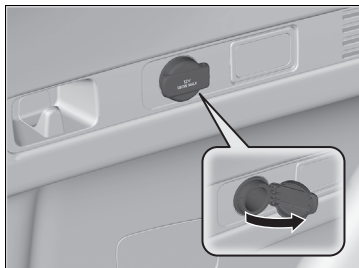

#### ■ Luggage area

Open the cover to use it.

### ►► Accessory Power Sockets

#### NOTICE

Do not insert an automotive type cigarette lighter element. This can overheat the accessory power socket.

The accessory power socket is designed to supply power for 12-volt DC accessories that are rated 180 watts (15 amps) or less.

To prevent 12-volt battery drain, only use the accessory power socket with the power system on.

When the accessory power socket is not in use, close the cover to prevent any small foreign objects from getting into the accessory power socket.

## Wireless Charger

To use the wireless charger, the power mode must be in ACCESSORY or ON. Charge any devices compatible with Qi wireless charging on the area indicated by the  mark as follows:

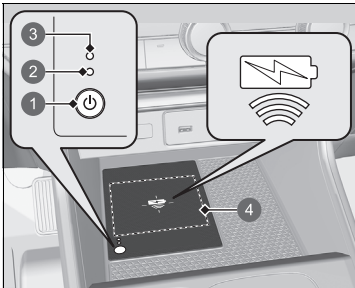

- ①  (Power) Button
- ② Green Indicator
- ③ Amber Indicator
- ④ Charging Area

1. To turn the system on and off, press and hold the  (power) button.
  - When the system is activated, the green indicator light comes on.
2. Place the device you want to charge on the charging area.
  - The system will automatically start charging the device, and the amber indicator light will come on.
  - Make sure that the device is compatible with the system, and placed with the chargeable side in the centre of the charging area.
3. When charging is completed, the green indicator light will come on.
  - Depending on the device, the amber indicator light will stay on.

### Wireless Charger

## CAUTION

**Metal objects between the charge pad and the device to be charged will get hot and can burn you.**

- Always remove foreign objects from the charge pad before charging the device.
- Be sure the surface is clear of dust and other debris before charging.
- Do not spill liquids (i. e. water, drinks, etc.) on the charger and the device.
- Do not use oil, grease, alcohol, benzine, or thinner for cleaning the charge pad.
- Do not cover the system with towels, clothing, or other objects while charging etc.
- Avoid spraying aerosols which may come in contact with the charge pad surface.

In order to use safely:

- Remove any metal objects from the charge pad before charging a device.
- Do not open the charger case.
- Do not use the charger if it malfunctions. Contact your dealer.

If the charger interferes with radio communications, attempt to correct the interference:

- Press and hold the switch on the charger for a few seconds to turn off the charger.

### ■ When charging does not start

Perform one of the solutions in the following table.

Indicator		Cause	Solution
Green & Amber	Blinking simultaneously	There is an obstacle(s) between the charging area and the device.	Remove the obstacle(s).
		The device is not within the charging area.	Pick up and reset the device to the centre of the charging area where  is located.
		The temperature of the wireless charger pad increases.	Temporarily suspend charging the device. Wait for the temperature to drop and attempt to charge the device again.
Amber	Blinking	The wireless charger is faulty.	Contact a dealer for repairs.

### ▶▶ Wireless Charger

This system consumes a lot of power. Do not use the system for a long time when the power system is off. This may weaken the 12-volt battery, making it difficult to turn the power system on.

When using the wireless charger, check the user's manual that came with the compatible device you want to charge.

The wireless charger can support up to 15W, but the charging rate varies based on the device and other conditions.

#### NOTICE

Do not place any magnetic recording media or precision machines within the charging area while charging. The data on your cards such as credit cards can be lost because of the magnetic effect. Also, precision machines such as watches can be affected.

“Qi” and  marks are the registered trademarks owned by Wireless Power Consortium (WPC).

In the following cases, charging may stop or not start:

- The device is already fully charged.
- The temperature of the device is extremely high while charging.
- You are at a place that emits strong electromagnetic waves or noises, such as a TV station, electric power plant, or petrol station.
- The device has a cover, case, or accessories which are not compatible with wireless charging.

A device may not charge if the size or shape of its chargeable side is not appropriate for use with the charging area.

Wireless Charger

Not all devices are compatible with the system.

During the charging phase, it is normal for the charging area and device to heat up.

Charging may be briefly interrupted when:

- All the doors and the tailgate are closed  
- to avoid interference with the proper functioning of the keyless access system.
- The position of the device is altered.

Do not charge more than one device at a time on a charging area.

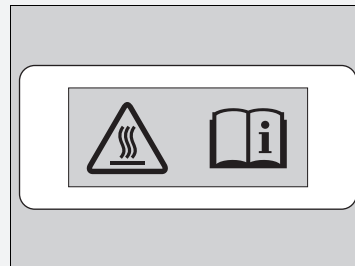

Burn risk:

Any metal objects placed between pad and device may become hot.

If the device becomes too hot and its battery protection function activates, it may charge extremely slowly or no longer charge.

The temperature at which the battery protection function activates depends on the device.

## ■ Heated Steering Wheel



The heated steering wheel can be used when the power mode is in ON.

Press the button on the lower side of the steering wheel.

When a comfortable temperature is reached, press the button again to turn it off.

The heated steering wheel is turned off every time you turn the power system on, even if you turned it on the last time you drove the vehicle.

## ▣ Heated Steering Wheel

Do not use the heated steering wheel continuously when the power system is off. Under such conditions, the 12-volt battery may be weakened, making it difficult to turn the power system on.

## Front Seat Heaters/ Ventilators\*



The seat heaters or ventilators can be used when the power mode is in ON.

The seat heaters: Use them to warm up the seat.

The seat ventilators: Use them when you want to ventilate the surface of the seats. When used with the air conditioning, the surface of the seats will become easier to cool.

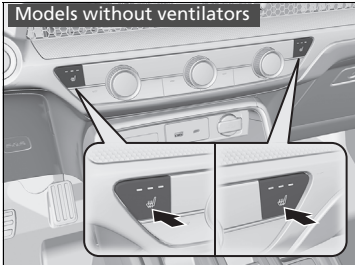

Models without ventilators

Press the seat heater or the seat ventilator button:

Once - The HI setting (three indicators on)

Twice - The MID setting (two indicators on)

Three times - The LO setting (one indicator on)

Four times - The OFF setting (no indicators on)

When the power mode is turned on after it is turned off, the previous setting is maintained.

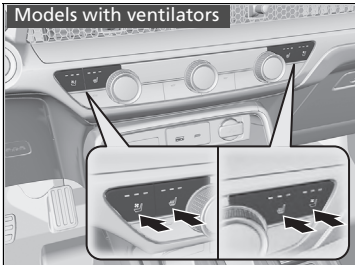

Models with ventilators

## Front Seat Heaters/ Ventilators\*

### ⚠ WARNING

Heat induced burns are possible when using seat heaters.

Persons with a diminished ability to sense temperature (e.g., persons with diabetes, lowerlimb nerve damage, or paralysis) or with sensitive skin should not use seat heaters.

Do not use the seat heaters even in LO when the power system is off. Under such conditions, the 12-volt battery may be weakened, making the power system difficult to start.

After a certain period of time, the strength setting for the front seat heaters will automatically be reduced by one level at a time until the front seat heaters shuts off. The elapsed time varies according to the interior environment.

\* Not available on all models

## ■ Rear Seat Heaters\*

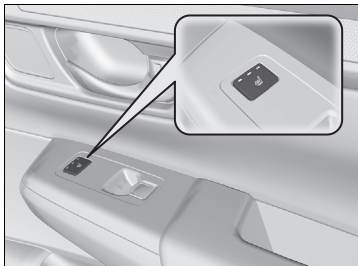

The seat heaters can be used when the power mode is in ON.

There is no heater in the rear centre seating position.

Press the seat heater button:

Once - The HI setting (three indicators on)

Twice - The MID setting (two indicators on)

Three times - The LO setting (one indicator on)

Four times - The OFF setting (no indicators on)

## ▣ Rear Seat Heaters\*

### **⚠ WARNING**

Heat induced burns are possible when using seat heaters.

Persons with a diminished ability to sense temperature (e.g., persons with diabetes, lowerlimb nerve damage, or paralysis) or with sensitive skin should not use seat heaters.

Do not use the seat heaters even in LO when the power system is off. Under such conditions, the 12-volt battery may be weakened, making the power system difficult to start.

After a certain period of time, the strength setting for the rear seat heaters will automatically be reduced by one level at a time until the rear seat heaters shuts off. The elapsed time varies according to the interior environment.

## Using Automatic Climate Control

The automatic climate control system maintains the interior temperature you select. The system also selects the proper mix of heated or cooled air that raises or lowers the interior temperature to your preference as quickly as possible.

Use the system when the power system is on.

1. Press the **AUTO** button.
2. Adjust the interior temperature using the driver's side or passenger's side temperature control dial.
3. Press the **ON/OFF** (ON/OFF) button to cancel.

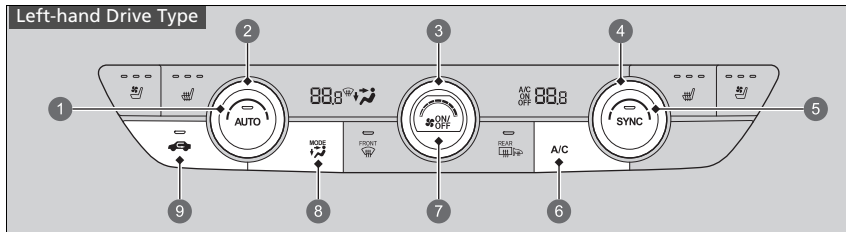

- 1 **AUTO** Button
- 2 Driver's Side Temperature Control Dial
- 3 Fan Control Dial
- 4 Passenger's Side Temperature Control Dial
- 5 **SYNC** Button
- 6 **A/C** (Air Conditioning) Button
- 7 **ON/OFF** Button
  - Dashboard vents
  - Dashboard and floor vents
  - Floor vents
  - Floor and windscreen demister vents
- 8 **MODE** Button
- 9 **Recirculation** Button

### Using Automatic Climate Control

If any buttons are pressed while using the climate control system in auto, the function of the button that was pressed will take priority.

The auto button indicator will go off, but functions unrelated to the button that was pressed will be controlled automatically.

To prevent cold air from blowing in from outside, the fan may not start immediately when the **AUTO** button is pressed.

If the interior is very warm, you can cool it down more rapidly by partially opening the windows, turning the system on auto, and setting the temperature to low. Change the fresh air mode to recirculation mode until the temperature cools down.

When you set the temperature to the lower or upper limit, **Lo** or **Hi** is displayed.

Pressing the **ON/OFF** button switches the climate control system between on and off. When turned on, the system returns to your last selection.

While **ECON** mode is active, the climate control system may have reduced cooling performance.

Continued

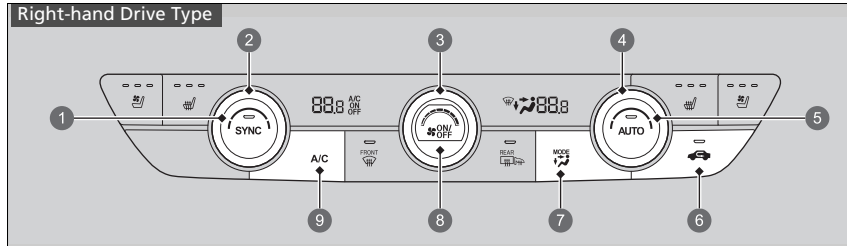

- ❶ **SYNC** Button
- ❷ **PASS** Button
- ❸ **MODE** Button
  - Dashboard vents
  - Dashboard and floor vents
  - Floor vents
  - Floor and windscreen demister vents
- ❹ **FRONT** Button
- ❺ **AUTO** Button
- ❻ **REAR** Button
- ❼ **ON/OFF** Button
- ❽ **A/C** (Air Conditioning) Button
- ❾ **RECIRCULATION** Button

■ **Switching between the recirculation and fresh air modes**

Press the (recirculation) button and switch the mode depending on environmental conditions.

Recirculation mode (indicator on): Recirculates air from the vehicle's interior through the system.

Fresh air mode (indicator off): Maintains outside ventilation. Keep the system in fresh air mode in normal situations.

## Defrosting the Windscreen and Windows

### Left-hand Drive Type

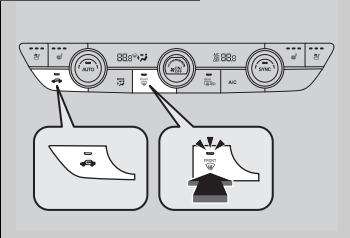

Pressing the  (windscreen demister) button turns the air conditioning system on and automatically switches the system to fresh air mode.

Press the  button again to turn off. The system returns to the previous settings.

### Right-hand Drive Type

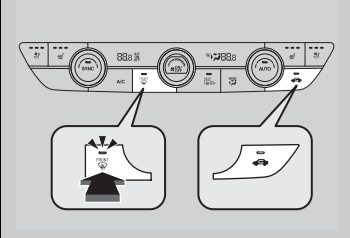

### Defrosting the Windscreen and Windows

**For your safety, make sure you have a clear view through all the windows before driving.**

Do not set the temperature near the upper or lower limit.

When cold air hits the windscreen, the outside of the windscreen may fog up.

### ■ To rapidly defrost the windows

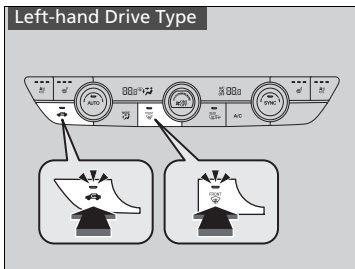

1. Press the  button.
2. Press the  button.

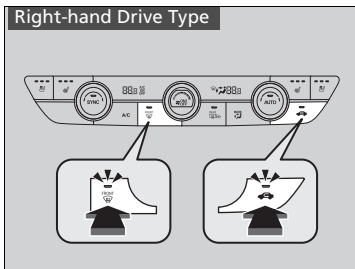

### ►► To rapidly defrost the windows

After defrosting the windows, switch over to fresh air mode. If you keep the system in recirculation mode, the windows may fog up from humidity. This impedes visibility.

## ■ Synchronization Mode

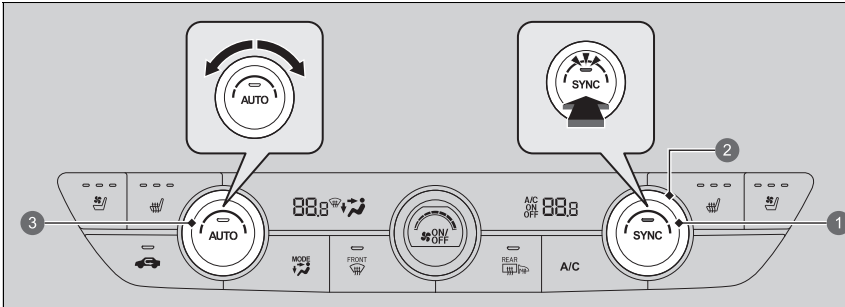

- ❶ **SYNC** Button
- ❷ Passenger's Side Temperature Control Dial
- ❸ Driver's Side Temperature Control Dial

You can set the temperature synchronously for the driver's side and the passenger's side in synchronization mode.

1. Press the **SYNC** button.
  - The system switches to synchronization mode.
2. Adjust the temperature using the driver's side temperature control dial.

Press the **SYNC** button or change the passenger's side temperature setting to return to dual mode.

## ☒ Synchronization Mode

When you press the  button, the system changes to synchronization mode.

When the system is in dual mode, the driver's side temperature and the passenger's side temperature can be set separately.

## Automatic Climate Control Sensors

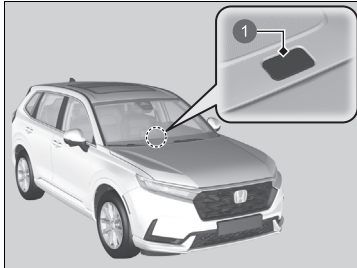

The automatic climate control system is equipped with sensors. Do not cover or spill any liquid on them.

1 Sensor

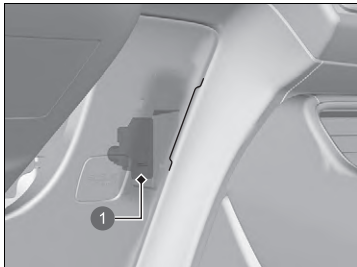

1 Sensor

# Features

This chapter describes how to operate technology features.



<b>Audio System</b> .....	290
<b>Display Audio</b> .....	292
<b>Audio Error Messages</b> .....	397
<b>General Information on the Audio System</b> .....	398
<b>Emergency Call (eCall)</b> .....	408
<b>Refuel Recommend</b> .....	413

## About Your Audio System

The audio system features FM/AM radio and Digital Audio Broadcasting (DAB) service. It can also play USB flash drives, iPod, iPhone, *Bluetooth*® devices, and smartphones.

You can operate the audio system from the buttons and knobs on the panel, the remote controls on the steering wheel or the icons on the touchscreen interface.

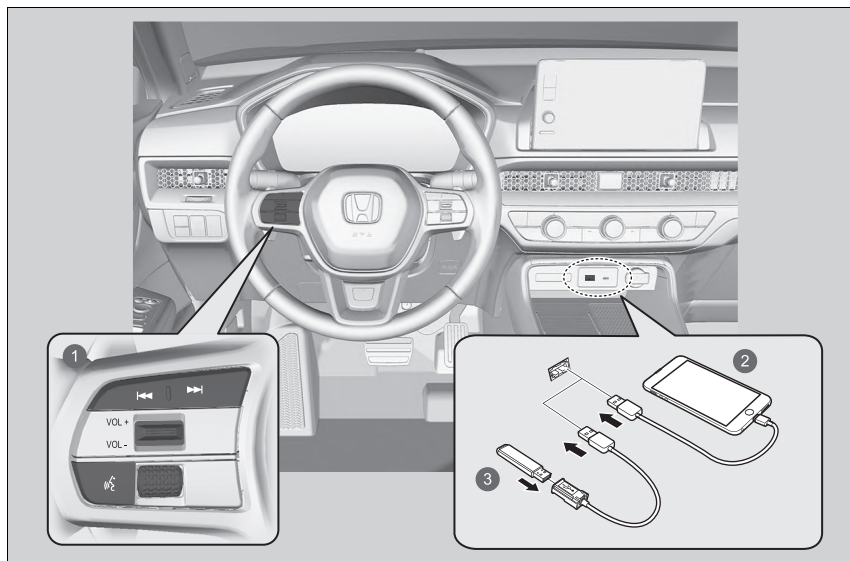

- 1 Remote Controls
- 2 Device
- 3 USB Flash Drive

### About Your Audio System

#### Key Off Operation

After you set the power mode to VEHICLE OFF, you can use the audio system for up to 30 minutes per driving cycle. However, whether you can continue using the audio system depends on the battery condition. Repeatedly using this feature may drain the battery.

## Audio System Theft Protection

---

The audio system is disabled when it is disconnected from the power source, such as when the 12-volt battery is disconnected or goes dead. In certain conditions, the system may display a code entry screen. If this occurs, reactivate the audio system.

### ■ Reactivating the audio system

1. Set the power mode to ON.
2. Turn on the audio system.
3. Press and hold the audio system power button for more than two seconds.
  - ▶ The audio system is reactivated when the audio control unit establishes a connection with the vehicle control unit. If the control unit fails to recognise the audio unit, you must go to a dealer and have the audio unit checked.

## Start Up

The Display Audio starts automatically when you set the power mode to ACCESSORY or ON. At start-up, the following screen about the data upload will be displayed.

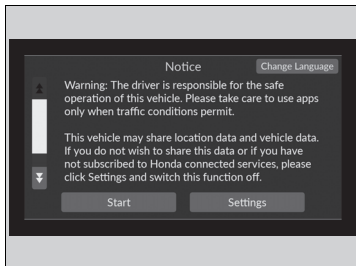

Select **Start**.

- ▶ If you want to change the settings for data upload, select **Settings**, then select the ON/OFF settings on the **Location and vehicle data sharing** screen.
- ▶ If you do not select **Start**, the system will automatically be switched the home screen after a certain period of time.
- ▶ If there is no registered device, select **Start** and the *Bluetooth*® pairing screen will be displayed.

### ■ To pair a mobile phone (when there is no phone paired to the system)

1. Make sure your phone is in search or discoverable mode.
2. Select **Honda HFT** from your phone.
  - ▶ If you want to pair a phone from this Display Audio, select **Search for Devices**, and then select your phone when it appears on the list.
  - ▶ If you check the box with **Do not show this again**, this screen will not be displayed.

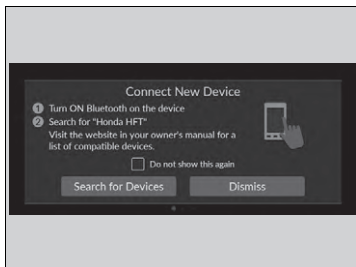

## Start Up

### Location and vehicle data sharing

**ON:** Data communication available.

**OFF:** Data communication unavailable.

## Basic Operation

### Audio System Function

To use the audio system function, the power mode must be in ACCESSORY or ON.



- |                            |  |
|----------------------------|--|
| ① All Apps                 | ⑥ Mode Change Switch Icons               |
| ② Status Icons             | ⑦  (Seek/Skip) Buttons                   |
| ③ App Shortcut Icons       | ⑧ <b>VOL/  AUDIO</b> (Volume/Power) Knob |
| ④ Arrow                    | ⑨  (Back) Button                         |
| ⑤ <b>Display Mode</b> Icon | ⑩  (Home) Button                         |

### Audio System Function

This screen is shown for the left-hand drive models. For the right-hand drive models, these are located at the symmetrically opposite to the left-hand drive model.

#### Key Off Operation

You can use the audio system for 30 minutes when the power mode is in VEHICLE OFF, the system will then turn off automatically.

If you want to keep using it, we recommend that you set the power mode to ACCESSORY or ON.

▶ **Key Off Operation** P. 290

**All Apps:** Displays all apps.

**Status Icons:** Show the indicators of the information for the vehicle, connected phones, etc. in the header area.

**App Shortcut Icons:** Display the app shortcut icons.

**Arrow:** Displays the next pages on the audio/information screen.

 **Display Mode Icon:** Changes the audio/information screen brightness. Select

 once and select  or  to make an adjustment.

**Mode Change Switch Icons:** Display icons to change the mode directly.

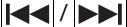
 (Seek/Skip) **Buttons:** Press to change station, song or file.

**VOL/  AUDIO (Volume/Power) Knob:** Turns the audio system on and off and turns to adjust the volume.

 **(Back) Button:** Presses to go to back to the previous screen.

 **(Home) Button:** Presses to go to the home screen.

## USB Ports

On the front panel

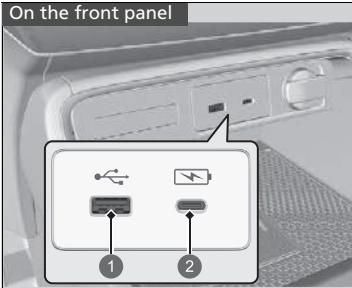

- ① Playing audio files and connecting compatible phones
- ② Only for charging devices

### ■ USB Charging/Connector Port (🔌🔌)

The USB port (2.5A) on the front panel is for charging devices, playing audio files, and connecting compatible phones with Apple CarPlay or Android Auto.

- ▶ To prevent any potential issues, be sure to use an Apple MFi Certified Lightning Connector for Apple CarPlay. For Android Auto, the USB cables should be certified by USB-IF to be compliant with USB 2.0 Standard.

On the back of the console compartment



### ■ USB Charging Port (🔌)

The USB ports (3.0A) are only for charging devices.

- ▶ You cannot play music even if you have connected music players to them.

## 🔌 USB Ports

- Do not leave the iPod or USB flash drive in the vehicle. Direct sunlight and high temperatures may damage it.
- We recommend that you use a USB cable if you are attaching a USB flash drive to the USB port.
- Do not connect the iPod or USB flash drive using a hub.
- Do not use a device such as a card reader or hard disk drive, as the device or your files may be damaged.
- We recommend backing up your data before using the device in your vehicle.
- Displayed messages may vary depending on the device model and software version.
- Some devices may not work even if they are connected to the USB ports.

### 🔌 USB charge

The USB port can supply up to 2.5A/3.0A of power. It does not output 2.5A/3.0A unless requested by the device.



For amperage details, read the operating manual of the device that needs to be charged.

Under certain conditions, a device connected to the port may generate noise to the radio station you are listening to.

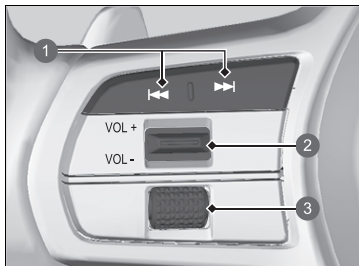
## ■ Audio Remote Controls



Allow you to operate the audio system while driving. The information is shown on the driver information interface.

- ①  /  (Seek/Skip) Buttons
- ② **VOL +** / **VOL -** (Volume) Switch
- ③ Left Selector Wheel

### **VOL +** / **VOL -** (Volume) Switch

**Press Up:** To increase the volume.

**Press Down:** To decrease the volume.

## ▶▶ Audio Remote Controls

Some modes appear only when an appropriate device or medium is used.







Depending on the *Bluetooth*® device you connect, some functions may not be available.

## Left Selector Wheel

### Roll up or down:

To cycle through the audio modes, roll up or down and then press the left selector wheel.

### (Seek/Skip) Buttons

- When listening to the radio
  - Press **: To select the next preset radio station.
  - Press **: To select the previous preset radio station.
  - Press and hold **: To select the next strong station.
  - Press and hold **: To select the previous strong station.
- When listening to a wired connection, USB flash drive, *Bluetooth*® Audio, or Smartphone Connection
  - ▶ Depending on a connected device, operations may be changed.
  - Press **: To skip to the next song.
  - Press **: To go back to the previous song.

## On-Board Owner's Manual

You can view the content of the owner's manual on the Display Audio.

The on-board owner's manual may be terminated without warning. If service is terminated, please continue to use the owner's manual via Honda website. For vehicles with the manual already installed, it can continue to be used as long as you do not perform a factory reset.

### ■ Open the Owner's Manual

1. Select **All Apps**.
2. Select **Owner's Manual**.

### ■ Install/Update the Owner's Manual

When you can install or update the owner's manual, the notification will be sent automatically.

To update:

1. Tap the notification.
  - ▶ The version screen will display.
2. Select items to be updated.
3. Tap **Update**.

If you unselect an item on the version screen, you will not receive any notifications for it.

### ▶▶ On-Board Owner's Manual

This function does not cover all languages available for the Display Audio.

Changing the language of the Display Audio will also change the language of the owner's manual. If the owner's manual is not available or installed in that language, the owner's manual will default to English.

### ▶▶ Install/Update the Owner's Manual

There may be differences in the displayed content depending on the version of the owner's manual.

If the owner's manual is not installed yet, you can install it via Wi-Fi.

▶ **Connect the Vehicle to a Wi-Fi Hotspot**  
P. 341

For languages except English, Germany, French, Italian and Spanish

If you install the owner's manual in a new language, the owner's manual you previously downloaded will be removed.

## Voice Control Operation

Your vehicle has a voice control system that allows hands-free operation.

The voice control system uses the  (talk) button on the steering wheel and a microphone near the map lights on the ceiling.

### ■ Voice Recognition

To achieve optimum voice recognition when using the voice control system:

- Make sure the correct screen is displayed for the voice command that you are using.



The system recognises only certain commands.

Available voice commands.

 **Voice Portal Screen** P. 300

- Close the windows.
- Adjust the dashboard and side vents so air does not blow onto the microphone on the ceiling.
- Speak clearly in a clear, natural speaking voice without pausing between words.
- Reduce any background noise if possible. The system may misinterpret your command if more than one person is speaking at the same time.

### ▶▶ Voice Control Operation

When you press the  button, a helpful prompt asks what you would like to do. Press and release the  button again to bypass this prompt and give a command.

Languages that the voice control system recognises are English, German, French, Spanish, and Italian.

## Voice Portal Screen

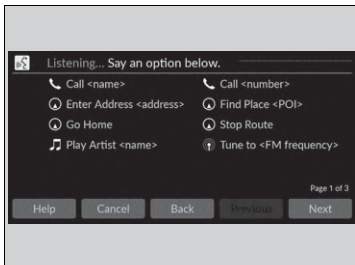

When the  (talk) button is pressed, available voice commands appear on the screen.

For a complete list of commands, say "Help" after the beep.

Depending on the selected mode, the displayed commands are different on the voice portal screen. The commands recognised are the same regardless of which screen is selected.

Normal Mode: A list of example commands is displayed to quickly complete your desired function.

Assist Mode: A list of basic commands is displayed to guide you step by step through the voice menu.

You can change the mode on the **General Settings** screen.

➔ **Voice Control** P. 367

The system only recognises the commands on the following pages, at certain screens. Free-form voice commands are not recognised.

## General Commands

When the voice portal screen is displayed, it will change to the top screen of each function by using the global commands.

- *Music Search*
- *AM*
- *FM*
- *Navigation*
- *Phone*

## Phone Commands

When the system recognises a phone command, the screen will change to the dedicated phone voice recognition screen. These commands can only be used when a phone is connected.

## Phone Commands

- *Call <name>*
- *Call <number>*

The system only recognises contact names stored in the phonebook of your phone. If a full name is registered in the first name field, the system will recognise the first name and last name as one contact name.

Phone commands are not available if using Apple CarPlay.

## Audio Commands

When the system recognises an audio command, the screen will change to the dedicated audio voice recognition screen.

## FM Commands

- *Tune to <FM frequency>*

## AM Commands

- *Tune to <AM frequency>*

## ■ iPod Commands

- *List Album* <name>
- *List Artist* <name>
- *List Genre* <name>
- *List Playlist* <name>
- *Play* <artist> <album>
- *Play*
- *Play Album* <name>
- *Play Artist* <name>
- *Play Genre* <name>
- *Play Music* <text:media\_combo>
- *Play Playlist* <name>
- *Play Song* <name>

## ■ USB Commands

- *List Album* <name>
- *List Artist* <name>
- *List Playlist* <name>
- *Play* <artist> <album>
- *Play*
- *Play Album* <name>
- *Play Artist* <name>
- *Play Music* <text:media\_combo>
- *Play Playlist* <name>
- *Play Song* <name>

## ■ Navigation Commands

The screen changes to the navigation screen.

📖 **Refer to the Navigation System Manual**

## ■ Standard Commands

- *Voice Help*
- *Cancel*
- *Back*

Voice Help provides guidance for the current screen.

## ■ List Commands

- *Previous*
- *Next*
- *Yes*
- *No*

## Audio/Information Screen

Displays the audio status and clock. From this screen, you can go to various setup options.

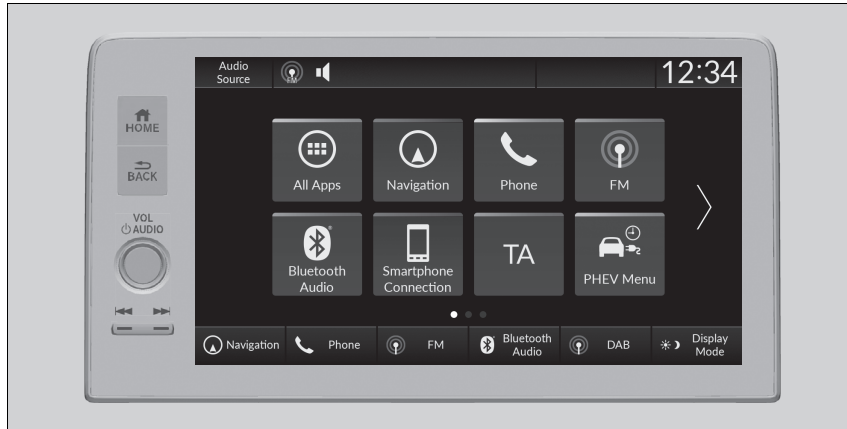

### Audio/Information Screen

#### Touchscreen Operation

- Use simple gestures - including touching, swiping, and scrolling - to operate certain audio functions.
- Some items may be greyed out during driving to reduce the potential for distraction.
- You can select them when the vehicle is stopped or use voice commands.
- Wearing gloves may limit or prevent touchscreen response.

You can change the touchscreen sensitivity setting.

► **Customized Features** P. 360

## ■ App Shortcut Function

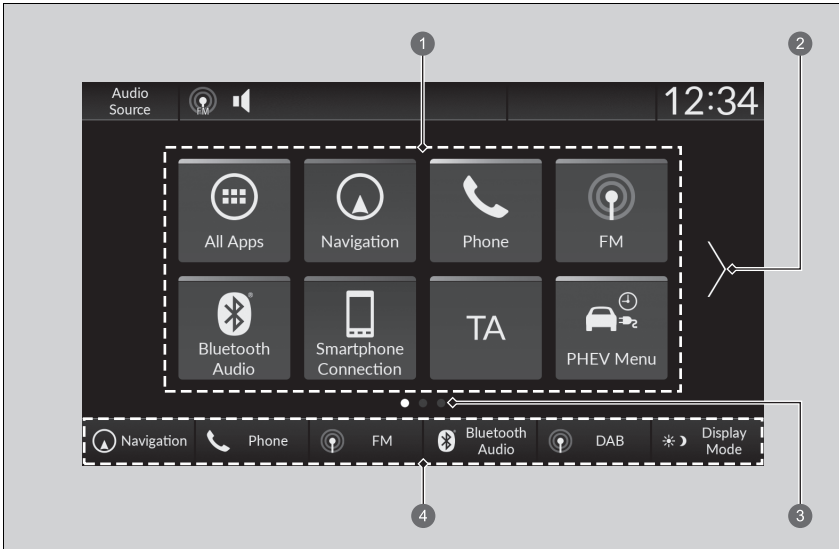

- ① App Shortcut Icons
- ② Arrow
- ③ Page Indicator
- ④ Mode Change Switches

### ■ To move to the next screen

Selecting  or , or swiping the screen left or right changes to the next screen.

## ▶▶ App Shortcut Function

The home screen can be added up to 6 pages.

Press the  button to go directly back to the first page of the home screen from any page.

### ■ To add app icons on the home screen

App icons can be added on the home screen.

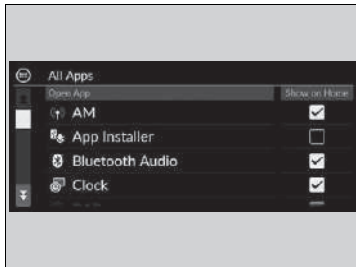

1. Press the  button.
2. Select **All Apps**.
3. Select the box checked on the desired apps.

## ■ To move icons on the home screen

You can change icon locations on the home screen.

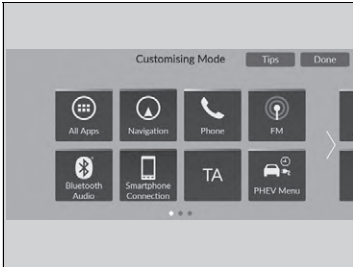

1. Press the  button.
2. Select and hold an icon.
  - ▶ The screen switches to the customization screen.
3. Drag and drop the icon to where you want it to be.
4. Select **Done**.
  - ▶ The screen will return to the home screen.

## ▶▶ To move icons on the home screen

Select **Tips** to show tips. To hide them, select it again.

## ■ To remove icons on the home screen

You can delete the icons on the home screen.

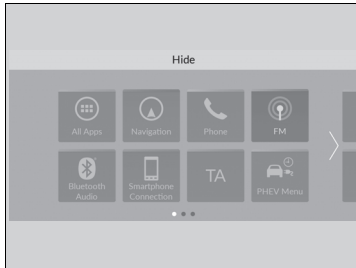

1. Press the **HOME** button.
2. Select and hold an icon.
  - ▶ The screen switches to the customization screen.
3. Drag and drop the icon you want to remove to the header area.
  - ▶ The icon is removed from the home screen.
4. Select **Done**.
  - ▶ The screen will return to the home screen.

## ▶▶ To remove icons on the home screen

You cannot delete the **All Apps** icon.

Apps will not be deleted by deleting the icon on the home screen.

Select **Tips** to show tips. To hide them, select it again.

## ■ To shortcut icons on the home screen

You can store up to six icons on the bottom of the home screen.



1 Mode Change Switches

1. Press the  button.
2. Select and hold an icon.
  - ▶ The screen switches to the customization screen.
3. Drag and drop the icon you want to store to the bottom of the home screen.
  - ▶ The icon is stored on the mode change switch area.
4. Select **Done**.
  - ▶ The screen will return to the home screen.

## ▶▶ To shortcut icons on the home screen

Select **Tips** to show tips. To hide them, select it again.

## ■ Status Area

Shows the indicators of the information for the vehicle, connected phones, etc. in the header area. You can confirm the detail information by selecting these icons.



1. Select the system status icon.
  - ▶ The status area appears.
2. Select an item to see the details.
3. Press the **BACK** button or select the system status icon to close the area.

### ① System Status Icon

## ■ Selecting an Audio Source

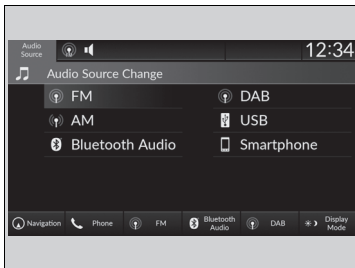



Select **Audio Source** in the header area, then select an icon on the source list to switch the audio source.

# Clock Setup

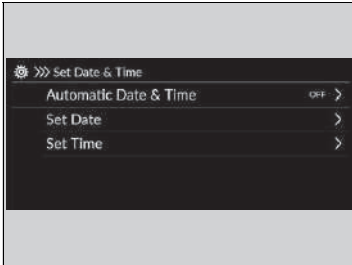

## ■ Adjusting the Clock

You can adjust the time manually and set the wallpaper of the clock in the audio/ information screen.





1. Press the  button.
2. Select **General Settings**.
3. Select **System**.
4. Select **Date & Time**.
5. Select **Set Date & Time**.
6. Select **Automatic Date & Time**, then select **OFF**.

To adjust date:

7. Select **Set Date**.
8. Select /.
9. Select **Save** to set the date.



To adjust time:

7. Select **Set Time**.
8. Select /.
9. Select **Save** to set the time.

## ▣ Adjusting the Clock

The clock is automatically updated through the audio system.

You can also adjust the clock by touching the clock displayed on the header area of the audio/ information screen, **Clock** displayed on the home screen, or **All Apps**.

1. Touch the clock on the screen.  
The clock screen of the face-type appears.
2. Select **Settings**.
3. Select **Date & Time**.
4. Select **Set Date & Time**.
5. Select **Automatic Date & Time**, then select **OFF**.
6. Select **Set Date** or **Set Time**.
7. Adjusting the dates, hours and minutes by selecting /.
8. Select **Save** to set the time.

You can customise the clock display.

▣ **System** P. 361

## ■ Clock Wallpaper Setup

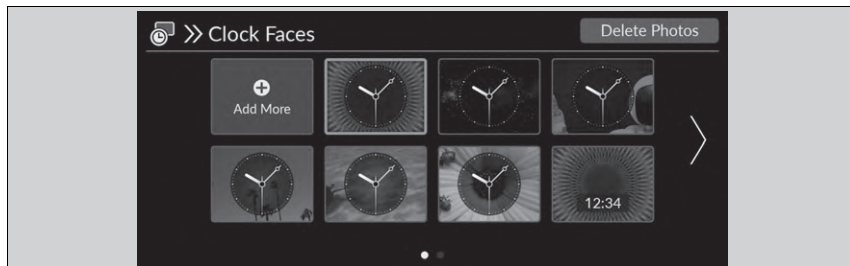

### ■ Import clock wallpaper

1. Connect the USB flash drive to the USB port.

▶ **USB Ports** P. 295

2. Press the **HOME** button.

3. Select **Clock**.

▶ If **Clock** is not displayed on the home screen, select **All Apps**.

4. Select **Settings**.

5. Select **Clock Faces**.

6. Select **Add More**.

▶ The image of the pictures stored in the USB flash drive are displayed on the list.

7. Select a desired picture to import.

▶ Multiple pictures can be selected at the same time.

8. Select **OK**.

▶ The selected pictures are displayed.

9. Select **Transfer**.

▶ It will return to the clock wallpaper setting screen.

### ▶ Clock Wallpaper Setup

- When importing wallpaper files, the image must be in the USB flash drive's root directory. Images in a folder cannot be imported.
- The file name must be less than 64 bytes.
- The file format of the image that can be imported is BMP (bmp) or JPEG (jpg).
- The individual file size limit is less than 10 MB.
- If the USB flash drive does not have any pictures, the message appears.
- Up to 11 pictures can be imported.
- The maximum image size is 4,096 x 2,304 pixels. If the image size is less than 1,280 x 720 pixels, the image is displayed in the middle of the screen with the extra area appearing in black.

## ■ Select clock wallpaper

1. Press the  button.
2. Select **Clock**.
  - ▶ If **Clock** is not displayed on the home screen, select **All Apps**.
3. Select **Settings**.
4. Select **Clock Faces**.
5. Select a desired picture to set.
  - ▶ The preview is displayed on the screen.
6. Select **Save**.
  - ▶ The clock screen which the wallpaper has been set is displayed.

## ■ Delete clock wallpaper

1. Press the  button.
2. Select **Clock**.
  - ▶ If **Clock** is not displayed on the home screen, select **All Apps**.
3. Select **Settings**.
4. Select **Clock Faces**.
5. Select **Delete Photos**.
6. Select a desired picture to delete.
  - ▶ Multiple pictures can be selected at the same time.
7. Select **OK**.
  - ▶ The selected pictures are displayed.
8. Select **Delete**.
  - ▶ It will return to the clock wallpaper setting screen.

## Adjusting the Sound

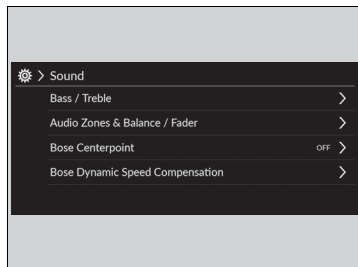

1. Press the  button.
2. Select an audio source icon.
3. Select **Sound**.

Select an item from the following choices:

- **Bass / Treble:** Treble, Midrange, Bass
- **Audio Zones & Balance / Fader:** Driver Only, Front Only, Rear Only, Full Vehicle, Balance, Fader
- **Bose Centerpoint:** Turns the Bose Centerpoint ON and OFF.
- **Bose Dynamic Speed Compensation:** Sets the amount of volume increase.

### ►► Adjusting the Sound

The **Bose Dynamic Speed Compensation** adjusts the volume level based on the vehicle speed. As you go faster, audio volume increases. As you slow down, audio volume decreases.

You can also adjust the sound by the following procedure.

1. Press the  button.
2. Select **General Settings**.
3. Select **Sound**.

#### Audio Zones & Balance / Fader

You can change where the sound comes from by selecting one of the speaker options below:

- **Full Vehicle:** All the speakers emit sound.
- **Driver Only:** Only the speaker by the driver's seat emits sound.
- **Front Only:** Only the front speakers emit sound.
- **Rear Only:** Only the rear speakers emit sound.

To reset each setting for **Bass / Treble**, **Audio Zones & Balance / Fader**, and **Bose Dynamic Speed Compensation**, select **Default** on each setting screen.

## Display Setup

You can set the screen brightness.

### Switching Display Mode Manually



Select **Display Mode**.

- ▶ The brightness bar is displayed for a few seconds.
- ▶ Select or to adjust the brightness.
- ▶ Select **Display OFF** to turn off the screen. To turn on the screen, press the or button.

### Display Setup

You can adjust the screen brightness by sliding or tapping on the brightness bar.

You can also change the screen brightness on the following procedures.

1. Press the button.
2. Select **General Settings**.
3. Select **Display**.
4. Select the setting you want.

To reset the settings, select **Default**.

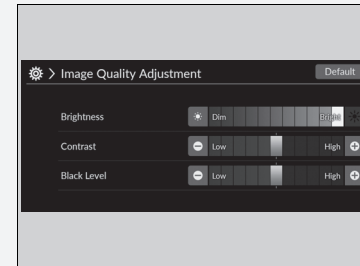



## System Updates

The audio system's firmware can be updated with a Wi-Fi connection, or with a USB device.

The audio system's firmware can be also updated with the telematics control unit (TCU) through the subscription-based service.

### How to Update

When the audio system update is available, the notification is shown on the status area. Use the following procedure to update the system.

1. Press the  button.
2. Select **System Updates**.
  - If **System Updates** is not displayed on the home screen, select **All Apps**.
  - The system will check for updates.
  - If the update icon is appeared on the home screen, select the status icon.  
 **Status Area** P. 308
3. Select **Download**.
  - A notification appears on the screen if need to user acceptance for download.
4. Select **Install Now** or **Install While Vehicle Off**.
  - A notification appears on the screen if the update is successful.

### How to Update

You can update the system via Wi-Fi, but cannot use the captive portal that requires login or agreement to the terms of use on the browser.

Your download will be cancelled if:

- Your Wi-Fi connection is severed.
- You turn off the power system when the 12-volt battery is low on power.

Your download will recommence the next time a Wi-Fi connection is established.

For 12-volt battery protection, **Install While Vehicle Off** cannot be selected when the battery is low on power. If you want to install the updated data, recharge the battery or select **Install Now**.

## ■ System Updates Settings

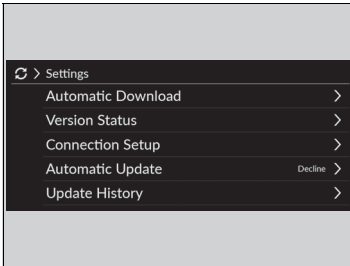

The following settings can be set.

- **Automatic Download**
- **Version Status**
- **Connection Setup**
- **Automatic Update**
- **Update History**

### ■ Automatic download settings

Use the following procedure to change to the automatic download setting.

1. Press the  button.
2. Select **System Updates**.
  - ▶ If **System Updates** is not displayed on the home screen, select **All Apps**.
3. Select **Settings**.
4. Select **Automatic Download**.
5. Select the access point, then select **Enable**.
  - ▶ If you do not want to system update automatically, select **Disable**.

### ■ View a version and update status

Use the following procedure to confirm the version and update status.

1. Press the  button.
2. Select **System Updates**.
  - ▶ If **System Updates** is not displayed on the home screen, select **All Apps**.
3. Select **Settings**.
4. Select **Version Status**.

## ■ Connection setup

Use the following procedure to connect to the Internet via a Wi-Fi network.

1. Press the  button.
2. Select **System Updates**.
  - ▶ If **System Updates** is not displayed on the home screen, select **All Apps**.
3. Select **Settings**.
4. Select **Connection Setup**.
5. Select **OK**.
6. Select an access point from the network list.
  - ▶ To connect to a hotspot that is not automatically detected, select **Options** then **Add Network**.
7. Enter the password.
  - ▶ If you check the **Use this network to automatically download system updates** box, you can set the network to be used for system updates.
8. Select **Connect**.

## ■ Automatic update settings

Use the following procedure to change to the automatic update setting.

1. Press the  button.
2. Select **System Updates**.
  - ▶ If **System Updates** is not displayed on the home screen, select **All Apps**.
3. Select **Settings**.
4. Select **Automatic Update**.
5. Select **Accept**.
  - ▶ If you do not want to system update automatically, select **Decline**.

## ■ View the update history

Use the following procedure to confirm the update history.

1. Press the  button.
2. Select **System Updates**.
  - ▶ If **System Updates** is not displayed on the home screen, select **All Apps**.
3. Select **Settings**.
4. Select **Update History**.

## ■ How to Update Wirelessly

### ■ Wireless connection mode setup



1. Press the  button.
2. Select **System Updates**.
  - ▶ If **System Updates** is not displayed on the home screen, select **All Apps**.
3. Select **Settings**.
4. Select **Connection Setup**.
5. Select **OK**.
6. Select an access point from the network list.
  - ▶ To connect to a hotspot that is not automatically detected, select **Options** then **Add Network**.
7. Enter the password.
  - ▶ If you check the **Use this network to automatically download system updates** box, you can set the network to be used for system updates.
8. Select **Connect**.

## ■ How to update

1. Press the  button.
2. Select **System Updates**.
  - ▶ If **System Updates** is not displayed on the home screen, select **All Apps**.
3. Select **via Wireless**.
4. Select **Download**.
  - ▶ A notification appears on the screen if need to user acceptance for download.
5. Select **Install Now** or **Install While Vehicle Off**.
  - ▶ A notification appears on the screen if the update is successful.

## ■ How to Update with a USB Device

### ■ Download the update files from the server



1. Press the  button.
2. Select **System Updates**.
  - ▶ If **System Updates** is not displayed on the home screen, select **All Apps**.
3. Select **Other Methods**.
4. Select **Via USB**.
  - ▶ A notification appears on the screen.
5. Connect a USB device into the USB port.
  - ▶ The inventory data is copied into the USB device.
    - ▶  **USB Ports** P. 295
6. Remove the USB device from the USB port.
7. Connect the USB device into your computer, and then download the update files.
  - ▶ Follow the link to download the required software update files. Refer to <https://usb.honda.com> for instructions.

### ▶▶ How to Update with a USB Device

A USB device with a minimum of 8 GB of free space or more is recommended.

Be sure to delete any previous inventory or update files from the USB before starting the USB update process.

## ■ Update the audio system

1. Press the  button.
2. Select **System Updates**.
3. Select **Other Methods**.
4. Select **Via USB**.
  - ▶ A notification appears on the screen.
5. Connect the USB device with the update files into the USB port.
  - ▶ A notification appears on the screen.
    - ▶  **USB Ports** P. 295
6. Select **Install Now**.
  - ▶ A notification appears on the screen if the update is successful.

## Playing FM/AM Radio

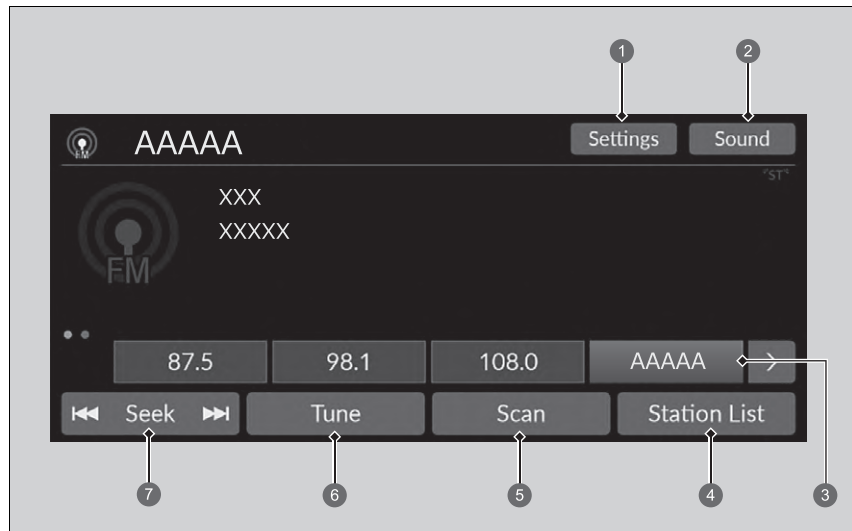

① Settings Icon

② Sound Icon

③ Preset Icons

④ Station List Icon

⑤ Scan Icon

⑥ Tune Icon

⑦ Seek Icon

## ■ Preset Memory

Tunes the radio frequency for preset memory.

To store a station:

1. Tune to the selected station.
2. Select and hold the preset icon to store that station.
  - ▶ Selecting **Press & Hold** can set a new preset station.

## ■ Station List

Lists the strongest stations on the selected band.

1. Select **Station List** to display a list.
2. Select the station.

## ■ Manual update

Updates your available station list at any time.



1. Select **Station List** to display a list.
2. Select **Refresh**.

## ■ Scan

Samples each of the strongest stations on the selected band for 10 seconds.

To begin scanning, select **Scan**, and to turn it off, select **Stop** or press the  button.

## ■ Seek

Selects  or  to search the selected band up or down for a station with a strong signal.

## ▶▶ Preset Memory

The **ST** indicator appears on the display indicating stereo FM broadcasts.

Switching the Audio Mode

Roll the left selector wheel or select **Audio Source** on the screen.

▶ **Audio Remote Controls** P. 296

You can store 12 AM/FM stations into preset memory.

## ■ Sound

Adjusts the sound settings.

▶ **Adjusting the Sound** P. 312

## ■ Radio Frequency Manual Tune Screen

Selects to use the on-screen keyboard for entering the radio frequency directly.

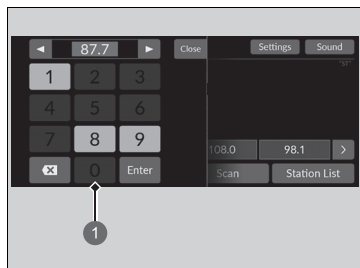

① On-screen Keyboard

## ▶▶ Radio Frequency Manual Tune Screen



**icons:**

Select ◀ or ▶ to tune the radio frequency.

## ■ Radio Data System (RDS)

Provides text data information related to your selected RDS-capable FM station.

### ■ To find an RDS station from Station List

1. Select **Station List** to display a list while listening to an FM station.
2. Select the station.

### ■ Manual update

Updates your available station list at any time.

1. Select **Station List** to display a list while listening to an FM station.
2. Select **Refresh**.

### ■ Traffic announcement (TA)

The TA standby function allows the system to stand by for traffic announcements in any mode while the function is on. The last tuned station must be an RDS-capable traffic program station.

**To turn the function on:** Select **TA**. When a traffic announcement begins, the information screen appears on the audio/information screen. The system returns to your last selected mode after the traffic announcement is finished.

- ▶ If you want to go back to your last selected mode during the traffic announcement, select **Stop**.

**To turn the function off:** Select **TA** again.

## ☒ Radio Data System (RDS)

When you select an RDS-capable FM station, the RDS automatically turns on, and the frequency display changes to the station name. However, when the signals of that station become weak, the display changes from the station name to the frequency.

## ☒ Traffic announcement (TA)

The **TA** indicator appears on the header area while the TA standby function is on.

If you select **Scan** while the TA standby function is on, the system searches TP station only.

Selecting **TA** while the traffic announcement is on does not cancel the TA standby function.

## ■ Settings

Changes the RDS settings.

1. Select **Settings**.

2. Select an option.

- **TA-Information:** Turns on and off the traffic information. (**ON/OFF**\*1)
- **AF:** Turns on and off to automatically change the frequency of the same program you enter different regions. (**ON**\*1/**OFF**)
- **REG:** Turns on and off to keep the same stations within that region even if the signal gets weak. (**ON**\*1/**OFF**)
- **NEWS:** Turns on and off to automatically to tune to the news program. (**ON/OFF**\*1)

\*1: Default Setting

## Playing DAB (Digital Audio Broadcasting)

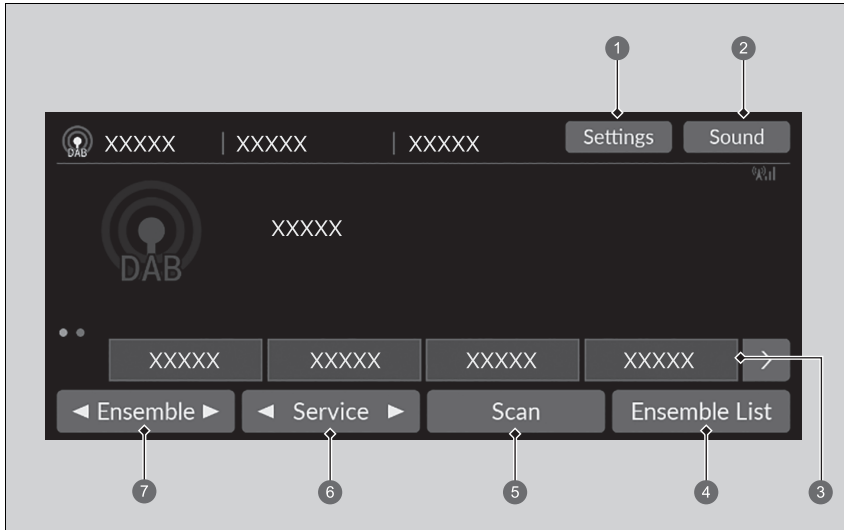

- ① Settings Icon
- ② Sound Icon
- ③ Preset Icons
- ④ Ensemble List Icon
- ⑤ Scan Icon
- ⑥ Service Icons
- ⑦ Ensemble Icons

## ■ Preset Memory

Tunes the preset frequency.

To store a service:

1. Tune to the selected service.
2. Select and hold the preset icon to store that station.
  - Selecting **Press & Hold** can set a new preset station.

## ■ Ensemble List

Lists the receivable ensembles on the selected service.

1. Select **Ensemble List** to display a list.
2. Select the ensemble.

### ■ Manual update

Updates your available ensemble list at any time.

1. Select **Ensemble List** to display a list.
2. Select **Refresh**.

## ■ Ensemble

Tunes the ensemble.

1. Select ◀ or ▶ to tune the ensemble.
2. Select and hold ◀ or ▶ to search the selected service up to down for an ensemble until a receivable ensemble is found.

## ■ Service

Tunes the service component.

To tune it, select ◀ or ▶.

## ▶▶ Preset Memory

Switching the Audio Mode

Roll the left selector wheel or select **Audio Source** on the screen.

▶▶ **Audio Remote Controls** P. 296

You can store 12 DAB stations into preset memory.

## ■ Scan

Samples each of the receivable ensemble or service on the selected service for 10 seconds.

To begin scanning, select **Scan**, and to turn it off, select **Stop** or press the  button.

## ■ Sound

Adjusts the sound settings.

 **Adjusting the Sound** P. 312

## ■ Settings

Changes the DAB settings.

1. Select **Settings**.
2. Select the option you want to change.

## Music Playback via Wired Connection

Using your USB connector, connect the device to the USB charging/connector port, then select the USB icon.

➤ **USB Ports** P. 295

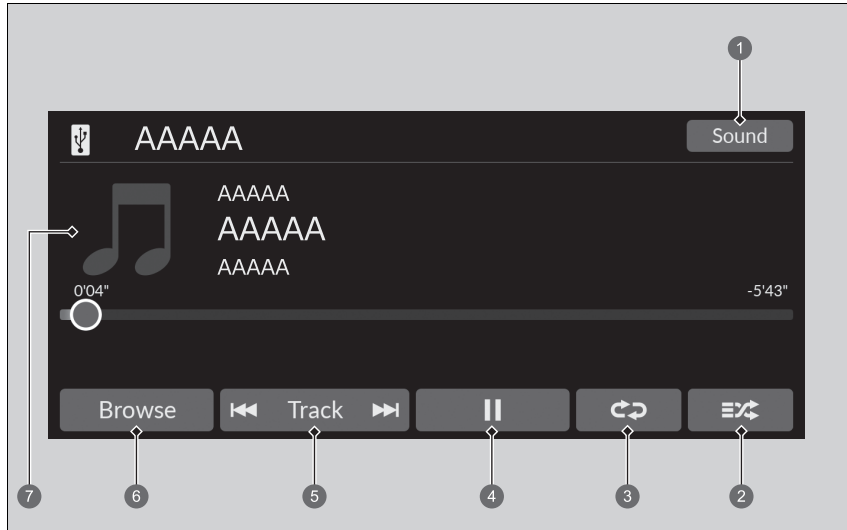

- ① Sound Icon
- ② Shuffle Icon
- ③ Repeat Icon
- ④ Play/Pause Icon
- ⑤ Track Icons
- ⑥ Browse Icon
- ⑦ Cover Art

### ▶▶ Music Playback via Wired Connection

Available operating functions vary on models or versions. Some functions may not be available on the vehicle's audio system.

If a smartphone is connected via Apple CarPlay or Android Auto, the USB source will be unavailable and audio files on the phone will be playable only within Apple CarPlay or Android Auto.

## ■ How to Select a Song from the Music Search List

You can select to display the music search list screen.

1. Select **Browse**.
2. Select a search category.
3. Continue making selections until you find the song of your choice.

## ■ How to Select a Play Mode

You can select shuffle and repeat modes when playing a song.

### ■ Shuffle/Repeat

Repeatedly select the shuffle or repeat icon until you find a play mode option of your preference.

 (shuffle off): Shuffle mode to off.



 (shuffle all songs): Plays all available songs in a selected list in random order.

 (repeat off): Repeat mode to off.

 (repeat song): Repeats the current song.

 (repeat all): Repeats all songs.

## ■ How to Change a Song

You can select  or  to change songs. Select and hold to move rapidly within a song.

## ■ Sound

You can adjust the sound settings.

➤ **Adjusting the Sound** P. 312

## Music Playback via USB Flash Drive

Your audio system reads and plays sound and video files on a USB flash drive. Connect your USB flash drive to the USB charging/connector port, then select the USB icon.

📁 **USB Ports** P. 295

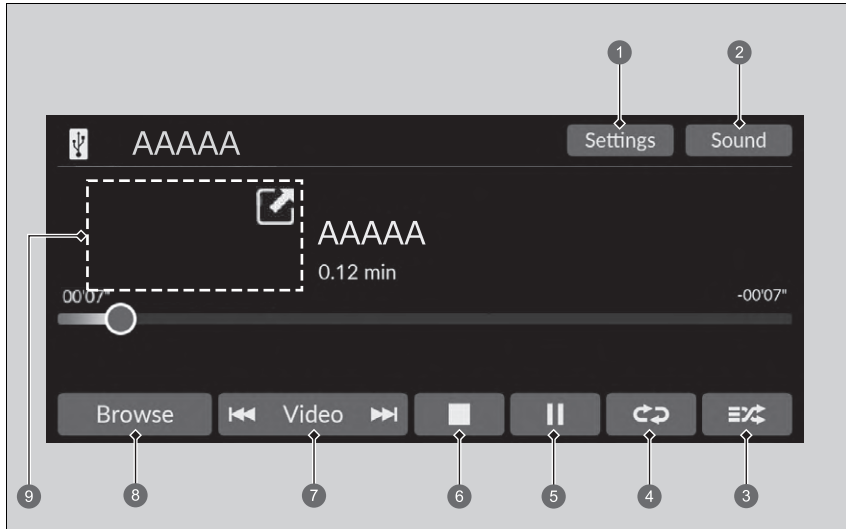

- |   |  |
|---|--|
| <ul style="list-style-type: none"> <li>① <b>Settings Icon</b> (Playing a video)</li> <li>② <b>Sound Icon</b></li> <li>③ <b>Random Icon</b></li> <li>④ <b>Repeat Icon</b></li> <li>⑤ <b>Play/Pause Icon</b></li> </ul> | <ul style="list-style-type: none"> <li>⑥ <b>Stop Icon</b> (Playing a video)</li> <li>⑦ <b>Track/Video Icons</b></li> <li>⑧ <b>Browse Icon</b></li> <li>⑨ <b>Cover Art</b> (Playing a music)/<br/><b>Mini Player</b> (Playing a video)</li> </ul> |
|---|--|

### 📁 Music Playback via USB Flash Drive

You can use the following formats to play sound or video files on a USB flash drive.

When playing a sound file: MP3, WMA, AAC\*1, FLAC, PCM/WAVE

When playing a video file: MP4, AVI, MKV, ASF/WMV

Use the recommended USB flash drives.

📁 **General Information on the Audio System**  
P. 398

WMA and AAC files protected by digital rights management (DRM) cannot be played. The audio system displays **Unplayable File**, then skips to the next file.

\*1: Only AAC format files recorded with iTunes are playable on this unit.

Continued

## ■ How to Select a File from the Music Search List

You can select to display the music search list screen.

1. Select **Browse**.
2. Select **Current Playlist, Music**, or **Video**.
3. Continue making selections until you find the file or video of your choice.

## ■ How to Select a Play Mode

You can select repeat and random modes when playing a file.

### ■ Random/Repeat

Repeatedly select random or repeat icon until you find a play mode option of your preference.

 (random off): Random mode to off.

 (random all files): Plays all files in random order.

 (random in folder): Plays all files in the current folder in random order.

 (repeat off): Repeat mode to off.

 (repeat file): Repeats the current file.



 (repeat folder): Repeats all files in the current folder.

### ■ When playing a video file

 / : Select  to shrink a video screen. Select  to expand a video screen.

## ■ How to Change a File

### Track/Video Icons

You can select  or  to change files. Select and hold to move rapidly within a file.

## ■ Sound

You can adjust the sound settings.

 **Adjusting the Sound** P. 312

## ■ Settings

Changes the USB settings when playing a video file.

1. Select **Settings**.
2. Select an option.
  - **Image Settings:** Changes the brightness of the audio/information screen. To reset the settings, select **Default**. (**Brightness/Contrast/Black Level/Colour/Tint**).
  - **Aspect Ratio:** Selects the display mode with a different aspect ratio. (**Original/Normal\*<sup>1</sup>/Full/Zoom**)
  - **Overlay Clock Location:** Changes the clock display layout. (**Upper right\*<sup>1</sup>/Upper left/Lower right/Lower left/OFF**)

\*1: Default Setting

## Playing *Bluetooth*® Audio

Your audio system allows you to listen to music from your *Bluetooth*-compatible phone.

This function is available when the phone is paired and connected to the vehicle's Hands-Free Telephone (HFT) system.

► **Phone Setup** P. 386

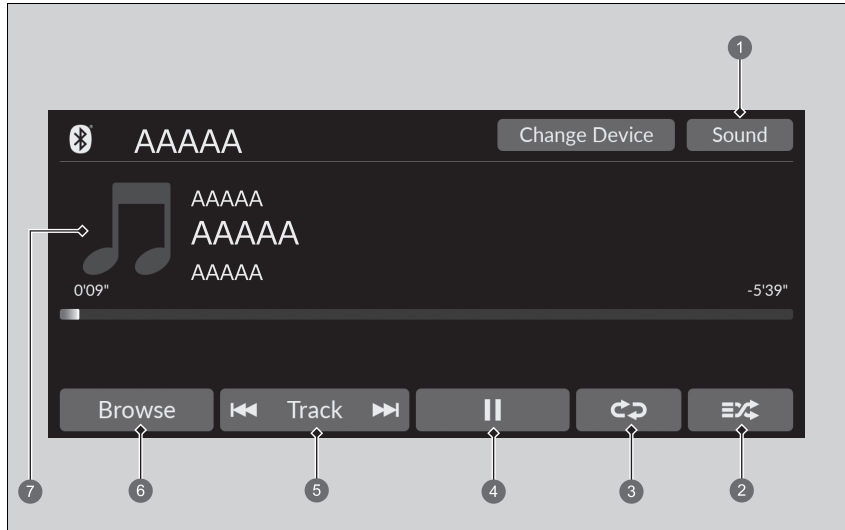

1 **Sound Icon**

2 **Shuffle Icon**

3 **Repeat Icon**

4 **Play/Pause Icon**

5 **Track Icons**

6 **Browse Icon**

7 **Cover Art**

### ►► Playing *Bluetooth*® Audio

Not all *Bluetooth*-enabled phones with streaming audio capabilities are compatible with the system. To check if your phone is compatible, ask a dealer.

It may be illegal to perform some data device functions while driving.

Only one phone can be used with HFT at a time. When there is more than one paired phone in the vehicle, the system automatically connects to the prioritized phone. You can assign priority to a phone in the *Bluetooth*® device list.

► **Phone Setup** P. 386

If more than one phone is paired to the HFT system, there may be a delay before the system begins to play.

In some cases, the name of the artist, album, or track may not appear correctly.

Some functions may not be available on some devices.

If a phone is currently connected via Apple CarPlay or Android Auto, *Bluetooth*® Audio from that phone will be unavailable. However, if the other phone is connected to the system, it can be used as *Bluetooth*® Audio by selecting the audio mode.

► **Phone Setup** P. 386

## ■ To Play *Bluetooth*® Audio Files

1. Make sure that your phone is paired and connected to the system.  
 **Phone Setup** P. 386
2. Select the *Bluetooth*® Audio mode.

If the phone is not recognised, another HFT-compatible phone, which is not compatible for *Bluetooth*® Audio, may already be connected.

## ■ How to Select a Play Mode

### ■ Shuffle/Repeat

Repeatedly select shuffle or repeat icon until you find a play mode option of your preference.

 (shuffle off): Shuffle mode to off.

 (shuffle all songs): Plays all available songs in a selected list in random order.

 (repeat off): Repeat mode to off.

 (repeat song): Repeats the current song.

 (repeat group): Repeats the current group.

 (repeat all): Repeats all songs.

## ▶▶ To Play *Bluetooth*® Audio Files

To play the audio files, you may need to operate your phone. If so, follow the phone maker's operating instructions.

Switching to another mode pauses the music playing from your phone.

You can change the connected phone by selecting **Change Device**.

 **Phone Setup** P. 386

## ■ Searching for Music

1. Select **Browse**.
2. Select a search category.
3. Select an item.
  - ▶ The selection begins playing.

## ■ Sound

You can adjust the sound settings.

➤ **Adjusting the Sound** P. 312

## ⌘ Searching for Music

Depending on the *Bluetooth*® device you connect, some or all of the lists may not be displayed.

# Message

**Message** connects you to the latest information from Honda.

## Message Menu

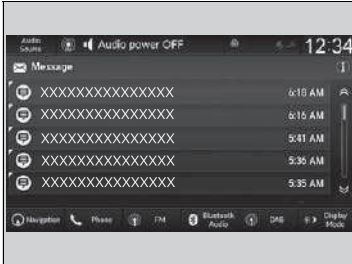

1. Press the  button.
2. Select **Message**.
  - ▶ If **Message** is not displayed on the home screen, select **All Apps**.
  - ▶ Messages display helpful and important information from Honda.

## Message

When the telematics control unit (TCU) is not available, use **Message** through Wi-Fi.

The **Message** connect app is compatible with most iPhone and Android phones.

Some mobile phone carriers charge for tethering and smartphone data use. Check your phone's data subscription package.

## ■ To Set Up to Connect Message Service

Use the following procedure to connect to **Message** service.

### ■ To enable the Message service

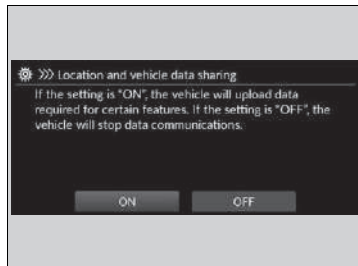

1. Press the  button.
2. Select **General Settings**.
3. Select **System**.
4. Select **Location and vehicle data sharing**.
5. Select **ON**.

## Message from Honda Tips

You can check the messages that are received quickly in the shortcut operation.

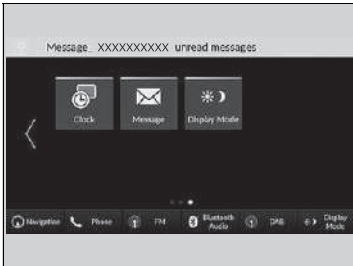

**1.** A notification appears and notifies you of a new message on the header area.

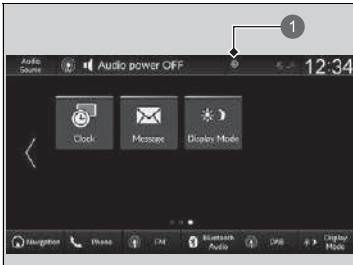

**2.** A notification icon is continuously displayed in the header area until the new message is read.

**3.** Select the notification icon to see the messages.

**1** Notification

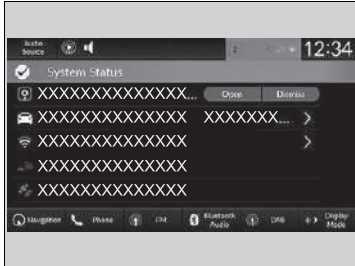

4. Select a new message to open.

## Wi-Fi Connection

This vehicle is equipped with Wi-Fi connectivity. You can connect to an external Wi-Fi hotspot or communication device. In addition, the vehicle can be used by other communication devices as a Wi-Fi hotspot via the telematics control unit (TCU).

- Connect the vehicle to a Wi-Fi hotspot
- Use Wi-Fi inside the vehicle

### ■ Connect the Vehicle to a Wi-Fi Hotspot

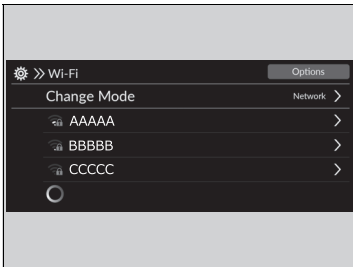

1. Press the button.
2. Select **General Settings**.
3. Select **Connections**.
4. Select **Wi-Fi**.
5. Select **OK**.
6. Select an access point from the network list.
  - ▶ To connect to a hotspot that is not automatically detected, select **Options** then **Add Network**.
7. Enter the password.
  - ▶ If you check the **Use this network to automatically download system updates** box, you can set the network to be used for system updates.
    - ▶ **System Updates** P. 314
8. Select **Connect**.

#### ■ Turning off the Wi-Fi connection

1. Select **Change Mode**.
2. Select **OFF**.

#### ▶ Wi-Fi Connection

Wi-Fi and Wi-Fi Direct are registered trademarks of Wi-Fi Alliance®.



#### ▶ Connect the Vehicle to a Wi-Fi Hotspot

You cannot go through the setting procedure while the vehicle is moving. Park in a safe place to set the audio system in Wi-Fi mode.

Some mobile phone carriers charge for tethering and smartphone data use. Check your phone's data subscription package.

Check your phone manual to find out if the phone has Wi-Fi connectivity.

You can confirm whether Wi-Fi connection is on or off with the icon on the system status area. Transmission speed and others will not be displayed on this screen.

▶ **Status Area** P. 308

In case of Wi-Fi connection with your phone, make sure your phone's Wi-Fi setting is in access point (tethering) mode.

Continued

## ■ Setting the Audio System as a Wi-Fi Hotspot

You can set the network as a Wi-Fi Hotspot of this audio system. Use the following steps to setup.

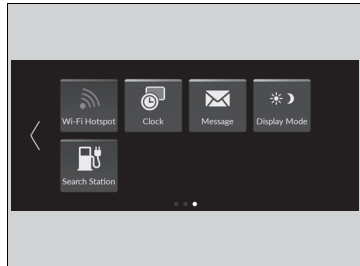

1. Press the button.
2. Select **Wi-Fi Hotspot**.
  - ▶ If **Wi-Fi Hotspot** is not displayed on the home screen, select **All Apps**.
3. Turn on the hotspot.
4. Select **Settings**.
  - ▶ **Network SSID** and **Password** are displayed, and you can change the settings.

The following settings are available for the setup.

- **Network SSID:** Set this network name.
- **Password:** Set password for require entering password when connecting Wi-Fi device to this network.
  - ▶ Passwords can be created with alphanumeric characters and some special characters.

### ▶▶ Setting the Audio System as a Wi-Fi Hotspot

Special characters that can be used in passwords.

!	)	;	]
"	*	<	^
#	+	=	-
\$	,	>	`
%	-	?	{
&	.	@	
'	/	[	}
(	:	~	

## Apple CarPlay

If you connect an Apple CarPlay-compatible iPhone to the system via the USB port or wirelessly, you can use Apple CarPlay on the audio/information screen.

📖 **USB Ports** P. 295

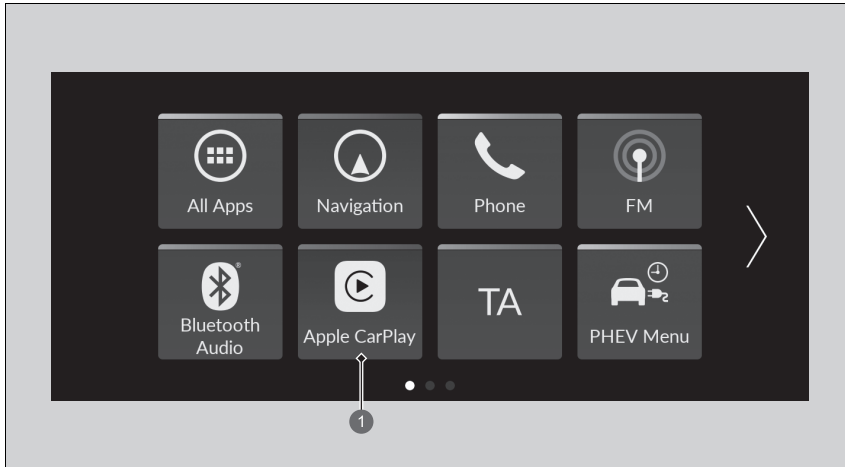

### 1 Apple CarPlay

#### 📖 Apple CarPlay

We recommend that you update iOS to the latest version when using Apple CarPlay.

Park in a safe place before connecting your iPhone to Apple CarPlay and when launching any compatible apps.

While connected to Apple CarPlay, it is not possible to use the *Bluetooth*® Audio or Hands-Free Telephone (HFT) system. You can only make calls or listen to music through Apple CarPlay. Other previously paired phones can use the *Bluetooth*® Audio.

When using Hands Free, you can only control it with Siri.

📖 **Operating Apple CarPlay with Siri** P. 347

Apple CarPlay and Android Auto cannot run at the same time.

For details on countries and regions where Apple CarPlay is available, as well as information pertaining to function, refer to the Apple website.

Use of Apple CarPlay will result in the transmission of certain user and vehicle information (such as vehicle location, speed, and status) to your iPhone to enhance the Apple CarPlay experience. You will need to consent to the sharing of this information on the audio/information screen.

Continued

## ■ Apple CarPlay Menu

For details on available applications, please refer to the Apple CarPlay website. Apps displayed on your screen can be changed with your iPhone.

Select the **Honda** icon on the Apple CarPlay menu screen to go back to the home screen.

## ■ Connecting Apple CarPlay Using the USB Cable

1. Connect the iPhone to the USB charging/connector port using the USB cable.

📖 **USB Ports** P. 295

▶ The confirmation screen will be displayed.

2. Select **Yes**.

▶ If you do not want to connect Apple CarPlay, select **No**.

You may change the consent settings under the **Smartphone Connection** settings menu.

## 📖 Apple CarPlay

### Apple CarPlay Operating Requirements & Limitations

Apple CarPlay requires a compatible iPhone with an active mobile connection and data plan. Your carrier's rate plans will apply.

Changes in operating systems, hardware, software, and other technology integral to providing Apple CarPlay functionality, as well as new or revised governmental regulations, may result in a decrease or cessation of Apple CarPlay functionality and services. Honda cannot and does not provide any warranty or guarantee of future Apple CarPlay performance or functionality.

It is possible to use third-party apps if they are compatible with Apple CarPlay. Refer to the Apple website for information on compatible apps.

You can also use the method below to set up Apple CarPlay:

Select General Settings →

Smartphone Connection → Apple CarPlay →



Select device.

### Use of user and vehicle information



The use and handling of user and vehicle information transmitted to/from your iPhone by Apple CarPlay is governed by the Apple iOS terms and conditions and Apple's Privacy Policy.

## ■ Connect Apple CarPlay Wirelessly

### ■ Connect Apple CarPlay wirelessly on the home screen

1. Press the  button.
2. Select **Smartphone Connection**.
3. Select **+ Connect New Device**.
4. Pair the iPhone to the vehicle's Hands-Free Telephone (HFT) system.
  - ▶  **Phone Setup** P. 386
5. Select **Yes**.
  - ▶ If your iPhone asks for permission to accept an Apple CarPlay connection, accept to connect.



### ■ Connect Apple CarPlay wirelessly on the Apple CarPlay device list

1. Press the  button.
2. Select **General Settings**.
3. Select **Smartphone Connection**.
4. Select **Apple CarPlay**.
5. Select **+ Connect New Device**.
6. Pair the iPhone to the vehicle's Hands-Free Telephone (HFT) system.
  - ▶  **Phone Setup** P. 386
7. Select **Yes**.
  - ▶ If your iPhone asks for permission to accept an Apple CarPlay connection, accept to connect.



## ☒ Connect Apple CarPlay Wirelessly

Wireless Apple CarPlay and Hotspot cannot be used at the same time. When using Apple CarPlay and Hotspot at the same time, connect to Apple CarPlay with a USB cable.

### ■ Connect Apple CarPlay wirelessly on the *Bluetooth*® device list

1. Press the  button.
2. Select **General Settings**.
3. Select **Connections**.
4. Select **Bluetooth**.
5. Select **+ Connect New Device**.
6. Pair the iPhone to the vehicle's Hands-Free Telephone (HFT) system.  
 **Phone Setup** P. 386
7. Check the box on **Apple CarPlay**.
  - ▶ If you select **Apple CarPlay**, you cannot select **Audio** and **Phone**.
8. Select **Connect**.
9. Select **Yes**.
  - ▶ If your iPhone asks for permission to accept an Apple CarPlay connection, accept to connect.

### ■ Connect Apple CarPlay wirelessly with the steering wheel

1. Press and hold the  (talk) button on the steering wheel.
2. Pair the iPhone to the vehicle's Hands-Free Telephone (HFT) system.  
 **Phone Setup** P. 386
3. Check the box on **Apple CarPlay**.
  - ▶ If you select **Apple CarPlay**, you cannot select **Audio** and **Phone**.
4. Select **Connect**.
5. Select **Yes**.
  - ▶ If your iPhone asks for permission to accept an Apple CarPlay connection, accept to connect.

## ■ Connect Apple CarPlay wirelessly at start-up (when there is no phone paired to the system)

1. Set the power mode to ACCESSORY or ON.
2. Select **Start**.
  - ▶ If there is no registered device, the *Bluetooth*® pairing screen will be displayed.
  - ▶ If you check the box with **Do not show this again**, this screen will not be displayed.
3. Pair the iPhone to the vehicle's Hands-Free Telephone (HFT) system.
  - ▶ **Phone Setup** P. 386
4. Check the box on **Apple CarPlay**.
  - ▶ If you select **Apple CarPlay**, you cannot select **Audio** and **Phone**.
5. Select **Connect**.
6. Select **Yes**.
  - ▶ If your iPhone asks for permission to accept an Apple CarPlay connection, accept to connect.

## ■ Operating Apple CarPlay with Siri

Press and hold the  (Talk) button to activate Siri.

Press again to deactivate Siri.

Press and release to activate standard voice recognition system.

### ▶ Operating Apple CarPlay with Siri

Below are examples of questions and commands for Siri:

- What movies are playing today?
- Call dad at work.
- What song is this?
- How's the weather tomorrow?
- Read my latest email.

For more information, please visit [www.apple.com/ios/siri](http://www.apple.com/ios/siri).

## Android Auto™

When you connect an Android™ phone to the audio system via the USB port, Android Auto is automatically initiated, and you can use Android Auto on the audio/information screen.

➤ **USB Ports** P. 295

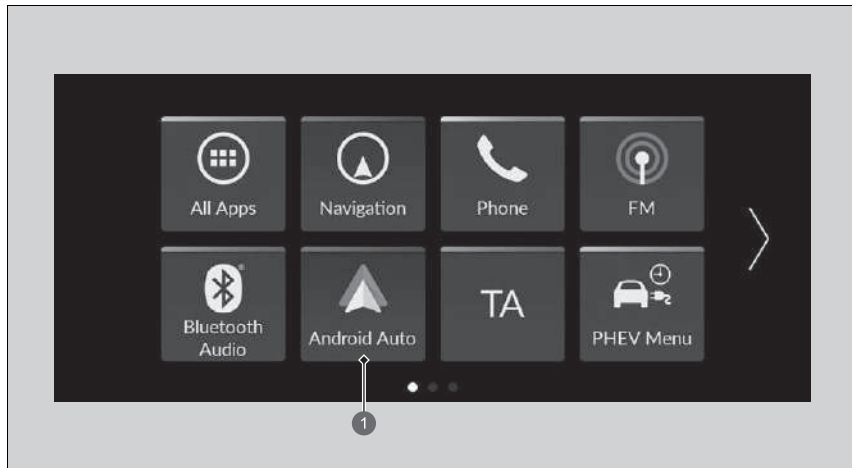

① **Android Auto**

### ▶▶ Android Auto™

We recommend that you update Android OS to the latest version when using Android Auto. *Bluetooth* A2DP cannot be used while your phone is connected to Android Auto.

Park in a safe place before connecting your Android phone to Android Auto and when launching any compatible apps.

When your Android phone is connected to Android Auto, it is not possible to use the *Bluetooth*® Audio. However, other previously paired phones can stream audio via *Bluetooth*® while Android Auto is connected.

➤ **Phone Setup** P. 386

Apple CarPlay and Android Auto cannot run at the same time.

Android and Android Auto are trademarks of Google LLC.

To use each of Android Auto's features: say a wakeup word while the Android Auto screen is displayed, or press and hold the (talk) button to activate Google Assistant.

➤ **Operating Android Auto with Voice Recognition** P. 351

## Android Auto Menu

For details on available applications, please refer to the Android Auto website. Apps displayed on your screen can be changed with your smartphone. Select the **Honda** icon on the Android Auto menu screen to go back to the home screen.

## Android Auto™

For details on countries and regions where Android Auto is available, as well as information pertaining to function, refer to the Android Auto website.

Screens may differ depending on the version of the Android Auto app you are using.

### Android Auto Operating Requirements & Limitations

Android Auto requires a compatible Android phone with an active mobile connection and data plan. Your carrier's rate plans will apply.

Changes in operating systems, hardware, software, and other technology integral to providing Android Auto functionality, as well as new or revised governmental regulations, may result in a decrease or cessation of Android Auto functionality and services. Honda cannot and does not provide any warranty or guarantee of future Android Auto performance or functionality.

It is possible to use third-party apps if they are compatible with Android Auto. Refer to the Android Auto website for information on compatible apps.

## ■ Enabling Android Auto

To enable Android Auto after connecting an Android phone to the USB charging/connector port, select **Yes** on the screen.

You may change the consent settings under the **Smartphone Connection** settings menu.

## ▣ Android Auto™

Only initialize Android Auto when you are safely parked. When Android Auto first detects your phone, you will need to set up your phone so that auto pairing is possible. Refer to the instruction manual that came with your phone.

You can use the method below to change Android Auto settings after you have completed the initial setup:

Select General Settings →  
Smartphone Connection → Android Auto →  
Select device.

### **Use of user and vehicle information**

The use and handling of user and vehicle information transmitted to/from your phone by Android Auto is governed by Google's Privacy Policy.

## ■ Operating Android Auto with Voice Recognition

Press and hold the  (Talk) button to operate Android Auto with your voice.  
Press and release to activate standard voice recognition system.

### ☒ Operating Android Auto with Voice Recognition

Below are examples of commands you can give with voice recognition:

- Reply to text.
- Call my wife.
- Navigate to Honda.
- Play my music.
- Send a text message to my wife.
- Call flower shop.

For more information, please refer to the Android Auto website.

## PHEV Menu

The several settings for the PHEV mode on the **PHEV Menu** screen. Select **PHEV Menu** on the home screen.

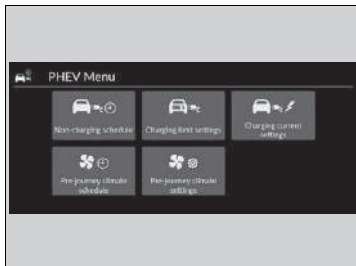

The following items can be set.

- Non-charging schedule
- Charging limit settings
- Charging current settings
- Pre-journey climate schedule
- Pre-journey climate settings

## ■ Non-charging Schedule Setting

Non-charging schedule can be set.  
Select a desired settings.

✎ **Setting the Charging Wait Time Schedule** P. 662

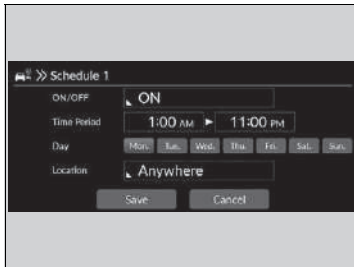

## ■ Charging Limit Settings

Charging limit can be set.  
Select a desired settings.

➤ **Maximum Charge Setting** P. 664

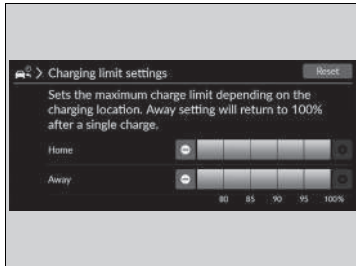

## ■ Charging Current Settings

Charging current can be set.  
Select a desired settings.

➤ **Charging Current Settings** P. 665

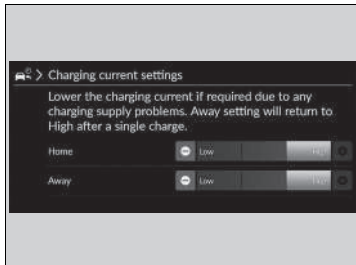

## Pre-Journey Climate Schedule Setting

Pre-Journey Climate Schedule causes the climate control system to operate in advance of the selected departure time in order to make the temperature inside the vehicle closer to your set temperature.

You can set up to 7 different schedules.

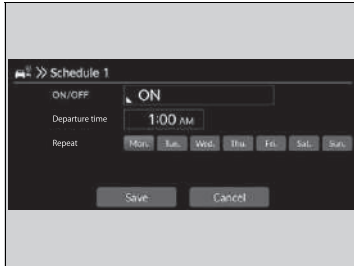

1. Select **ON/OFF**, and then select settings for all items in order starting from the top.
2. Select **Save**.

## Pre-Journey Climate Schedule Setting

Pre-Journey Climate can only operate for up to 30 minutes. A new schedule cannot be set if there is another valid schedule within those 30 minutes.

The system does not operate when the charging connector is not connected.

## ■ Pre-Journey Climate Settings

Pre-journey climate settings can be set.  
Select a desired settings.

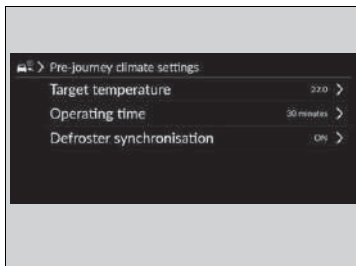

The following items can be set.

- **Target temperature:** Selects temperature adjustments. (Lo ~ 15.5 ~ 22.0<sup>\*1</sup> ~ 28.5 ~ Hi)
- **Operating time:** Selects operating time. (10 minutes/20 minutes/30 minutes<sup>\*1</sup>)
- **Defroster synchronisation:** The On/Off settings for operating the defroster automatically. (ON<sup>\*1</sup>/OFF)

\*1: Default Setting

## Power Flow

The power flow screen shows the vehicle's power flow, and range on the remaining power and fuel.

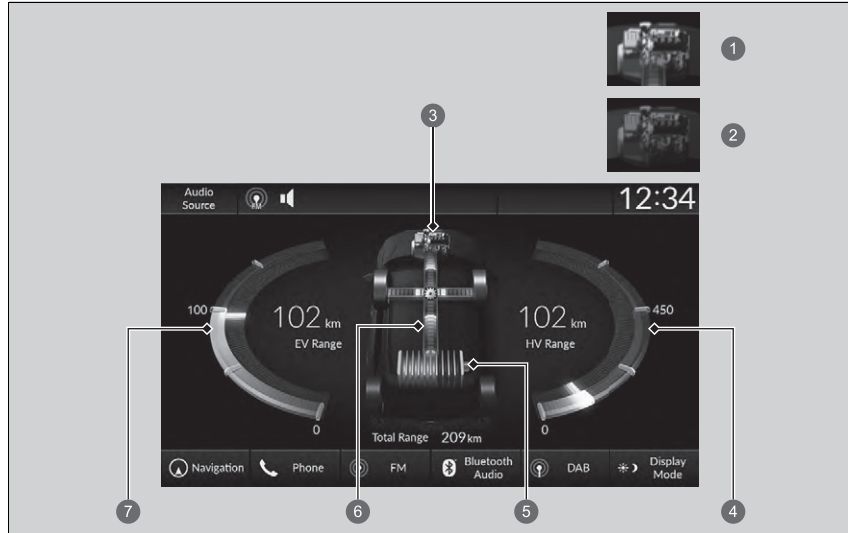

- ① Engine ON
- ② Engine OFF
- ③ Engine
- ④ Hybrid Range
- ⑤ High Voltage Battery Level Gauge
- ⑥ Power Flow
- ⑦ Electric Range



### Power Flow

The power flow monitor is also displayed on the driver information interface.

▶ **Power Flow Monitor** P. 166

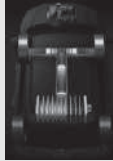

Shows the power flow, indicating what is supplying power to the vehicle and/or charging the battery.

- ▶ The indicator for the power transmission appears in blue, and for the battery charging operation, in green.

Display	Colour of indicators	Vehicle's Condition
	Blue	Power is being supplied by the High Voltage battery and the engine-driven generator.
	Blue	Power is being supplied by the High Voltage battery.
	Blue	Power is being supplied by the engine-driven generator.

▶▶ Power Flow

While the engine provides propulsion directly to the wheels, the  icon appears in the power flow monitor on the screen.

Display	Colour of indicators	Vehicle's Condition
	Blue and Green	Power is being supplied directly by the engine and the High Voltage battery is being charged by the engine-driven generator.
	Green	The High Voltage battery is being charged through regenerative braking.
	Green	The High Voltage battery is being charged by the engine-driven generator.

## Customized Features

Use the audio/information screen to customize certain features.

### ■ How to Customize the General Settings

With the power mode in ON, select **General Settings**, and select a setting item.

- **System** ⓘ P. 361
- **Smartphone Connection** ⓘ P. 363
- **Connections** ⓘ P. 364
- **Display** ⓘ P. 365
- **Sound** ⓘ P. 365
- **Camera** ⓘ P. 366
- **Voice Control** ⓘ P. 367

### ⌘ Customized Features

When you customize settings, make sure that the vehicle is at a complete stop and shift to **P**.

■ System

Customizable Features		Description	Selectable Settings	
Date & Time	<b>Automatic Date &amp; Time</b>	Select <b>ON</b> to have the GPS automatically adjust the clock. Select <b>OFF</b> to cancel this function.	<b>ON</b> *1/ <b>OFF</b>	
	<b>Set Date &amp; Time</b>	<b>Set Date</b>	Adjusts date. 📄 <b>Adjusting the Clock</b> P. 309	<b>Day/Month/Year</b>
		<b>Set Time</b>	Adjusts time. 📄 <b>Adjusting the Clock</b> P. 309	<b>Hour/Minute AM/PM</b>
	<b>Time Zone</b>	<b>Automatic Time Zone</b>	Sets the audio system to automatically adjust the clock when driving through different time zones.	<b>ON</b> *1/ <b>OFF</b>
		(Select time zone)	Changes the time zone manually.	—
	<b>Auto Daylight Saving Time</b>	Sets the clock to update based on daylight savings time.	<b>ON</b> *1/ <b>OFF</b>	
	<b>Date Format</b>	Select a date format.	<b>MM/DD/YYYY/ DD/MM/YYYY</b> *1/ <b>YYYY/MM/DD</b>	
	<b>Time Format</b>	Select a time format.	<b>12-H</b> *1/ <b>24-H</b>	



\*1:Default Setting

Customizable Features	Description	Selectable Settings
<b>Language</b>	Changes the driver information interface and audio/information screen language separately.	<b>English</b> * <sup>1</sup> Some languages may not be available in all regions. Check the audio/information screen for available options.
<b>Touch Panel Sensitivity</b>	Sets the sensitivity of the touch panel screen.	<b>High/Normal</b> * <sup>1</sup>
<b>System Volumes</b>	<b>System Sounds</b>	Sets the system sound volume level. —
	<b>Text-to-Speech</b>	Sets the text-to-speech volume level. —
	<b>Navigation Guidance</b>	Sets the navigation guidance volume level. —
	<b>Phone Calls</b>	Sets the phone call volume level. —
	<b>Default</b>	Resets all <b>System Volumes</b> settings to default values.
<b>Location and vehicle data sharing</b>	<b>Location and vehicle data sharing</b> Turns data sharing setting on and off. ▶ <b>Start Up</b> P. 292	<b>ON/OFF</b> * <sup>1</sup>
<b>Refuel Recommend</b>	Turns the refuel recommend function on and off. ▶ <b>Refuel Recommend</b> P. 413	<b>ON</b> * <sup>1</sup> / <b>OFF</b>

\*1:Default Setting

Customizable Features		Description	Selectable Settings
<b>About</b>	<b>Status</b>	Displays the Android setting items.	—
	<b>Legal Information</b>		
	<b>Model Number</b>		
	<b>Android Version</b>		
	<b>Kernel Version</b>		
	<b>Build Number</b>		
<b>Factory Data Reset</b>		Resets all the settings to their factory default.  <b>Defaulting All the Settings</b> P. 378	<b>Continue/Cancel</b>
<b>Detail Information</b>	<b>App Manager</b>	Displays the Android system memory and apps information.	—

■ **Smartphone Connection**

Customizable Features		Description	Selectable Settings
<b>Apple CarPlay</b>	<b>+ Connect New Device</b>	Pairs a new phone to Apple CarPlay.  <b>Phone Setup</b> P. 386	—
	(Saved Devices)	Connects, disconnects, or deletes a paired phone.  <b>Phone Setup</b> P. 386	—
<b>Android Auto</b>	(Saved Devices)	Connects, disconnects, or deletes a paired phone.  <b>USB Ports</b> P. 295	—

■ **Connections**

	Customizable Features	Description	Selectable Settings	
Wi-Fi	<b>Change Mode</b>	Changes the Wi-Fi mode.	<b>Network/ Smartphone*<sup>2</sup>/OFF*<sup>1</sup></b>	
	(Available Networks/Connected Devices)	Displays the available network(s) or current connected device(s).	—	
	<b>Options</b>	<b>Add Network</b>	Adds a new network to connect Wi-Fi.	—
		<b>Saved Networks</b>	Saves the connected network.	—
	<b>Setup</b>	<b>Network SSID</b>	Sets the network name.	—
		<b>Security</b>	Displays the network security.	—
		<b>Password</b>	Sets password for require entering password when connecting Wi-Fi device to the network.	—
		<b>Wi-Fi Band</b>	Displays the Wi-Fi band.	—
Bluetooth	<b>Options</b>	<b>Bluetooth</b>	Turns <i>Bluetooth</i> ® on and off.	<b>ON*<sup>1</sup>/OFF</b>
		<b>Priority Device</b>	Displays the priority device.	—
	<b>+ Connect New Device</b>	Pairs a new phone to HFT. 📱 <b>Phone Setup</b> P. 386	—	
(Saved Devices)	Connects, disconnects, or deletes a paired phone. 📱 <b>Phone Setup</b> P. 386	—		

\*1:Default Setting

\*2:Appears only when Apple CarPlay is connected wirelessly.

■ Display

Customizable Features	Description	Selectable Settings
<b>Brightness</b>	Changes the brightness of the audio/information screen.	—
<b>Contrast</b>	Changes the contrast of the audio/information screen.	—
<b>Black Level</b>	Changes the black level of the audio/information screen.	—
<b>Default</b>	Resets all customized settings for the brightness, contrast, and black level.	—

\*1:Default Setting

■ Sound

Customizable Features	Description	Selectable Settings						
<table border="0"> <tr> <td rowspan="3"><b>Bass / Treble</b></td> <td><b>Treble</b></td> <td rowspan="3">Adjusts the settings of the audio speakers' sound.                      ▶ <b>Adjusting the Sound</b> P. 312</td> <td rowspan="3">—</td> </tr> <tr> <td><b>Midrange</b></td> </tr> <tr> <td><b>Bass</b></td> </tr> </table>	<b>Bass / Treble</b>	<b>Treble</b>	Adjusts the settings of the audio speakers' sound. ▶ <b>Adjusting the Sound</b> P. 312	—	<b>Midrange</b>	<b>Bass</b>		
<b>Bass / Treble</b>		<b>Treble</b>			Adjusts the settings of the audio speakers' sound. ▶ <b>Adjusting the Sound</b> P. 312	—		
		<b>Midrange</b>						
	<b>Bass</b>							
<b>Audio Zones &amp; Balance / Fader</b>								
<b>Bose Centerpoint</b>								
<b>Bose Dynamic Speed Compensation</b>								

■ Camera

Customizable Features	Description	Selectable Settings
<b>LaneWatch</b>	<b>Show with indicator</b> Selects whether the LaneWatch display comes on when you move the turn signal lever to indicate a left <sup>*2</sup> /right <sup>*3</sup> turn. ➤ <b>LaneWatch</b> P. 475	<b>ON<sup>*1</sup>/OFF</b>
	<b>Display Time after Indicator Off</b> Changes the length of time the LaneWatch display stays on after the turn signal lever returns to the centre. ➤ <b>LaneWatch</b> P. 475	<b>0 seconds<sup>*1</sup>/2 seconds</b>
	<b>Show Reference Line</b> Selects whether the reference lines come on the LaneWatch monitor. ➤ <b>LaneWatch</b> P. 475	<b>ON<sup>*1</sup>/OFF</b>

\*1:Default Setting

\*2:Right-hand Drive Type

\*3:Left-hand Drive Type

Customizable Features		Description	Selectable Settings
<b>Multi View Camera</b>	<b>Guidelines</b>	<b>Fixed Guideline</b> Shows the guideline that does not move with the steering wheel. ▶ <b>Multi-View Camera</b> P. 612	<b>ON*1/OFF</b>
		<b>Dynamic Guideline</b> Shows the guideline that moves with the steering wheel. ▶ <b>Multi-View Camera</b> P. 612	<b>ON*1/OFF</b>
	<b>Customise</b>	<b>Show after shifting from Reverse</b> Selects whether to display the forward camera image after shifting from <b>[R]</b> to <b>[D]</b> .	<b>ON/OFF*1</b>
		<b>Auto display when obstacle is detected</b> Displays the forward camera image when a parking sensor detects an obstacle.	<b>ON*1/OFF</b>
<b>Front cross traffic warning</b>		Turn On or Off the front cross traffic warning on camera display.	<b>ON*1/OFF</b>
<b>Cross Traffic Monitor</b>		Shows arrows on the rear camera image to indicate vehicles approaching from the sides. ▶ <b>Cross Traffic Monitor</b> P. 607	<b>ON*1/OFF</b>

\*1:Default Setting

■ **Voice Control**

Customizable Features	Description	Selectable Settings
<b>Voice Control Mode</b>	Selects the mode of the voice portal screen. ▶ <b>Voice Control Operation</b> P. 299	<b>Assist/Normal*1</b>

\*1:Default Setting

## ■ How to Customize the Vehicle Settings

With the power mode in ON, select **Vehicle Settings**, then select a setting item.

- **Deflation warning system** ⓘ P. 369
- **Driver attention monitor** ⓘ P. 369
- **Driver assist system setup** ⓘ P. 370
- **Meter/HUD setup** ⓘ P. 372
- **Driving position setup** ⓘ P. 374
- **Keyless access setup** ⓘ P. 374
- **Lighting setup** ⓘ P. 375
- **Door/window setup** ⓘ P. 376
- **Power tailgate setup** ⓘ P. 376
- **Predictive Eco Assist** ⓘ P. 377
- **Engine oil level check reminder** ⓘ P. 377
- **Maintenance info.\*** ⓘ P. 377

## ⓘ How to Customize the Vehicle Settings

If **Vehicle Settings** is not displayed on the home screen, select **All Apps**. You can change the displayed icons on the home screen.

- ⓘ **App Shortcut Function** P. 303

■ **Deflation warning system**

Customizable Features	Description	Selectable Settings
<b>Deflation warning system</b>	Cancels/Calibrates Deflation Warning System. <input checked="" type="checkbox"/> <b>Deflation Warning System</b> P. 469	<b>Calibrate/Cancel</b>

■ **Driver attention monitor\*2**

Customizable Features	Description	Selectable Settings
<b>Driver drowsiness alert</b>	Turns On/Off driver drowsiness alert. <input checked="" type="checkbox"/> <b>Driver Attention Monitor</b> P. 525	<b>ON*1/OFF</b>
<b>Driver distraction alert</b>	Turns On/Off driver distraction alert. <input checked="" type="checkbox"/> <b>Driver Attention Monitor</b> P. 525	<b>ON*1/OFF</b>

\*1:Default Setting

\*2:You can select **All Off** to turn off the Driver attention monitor features.

■ Driver assist system setup

Customizable Features	Description	Selectable Settings
<b>Preceding vehicle proximity warning distance</b>	Changes the distance at which Collision Mitigation Braking System (CMBS) alerts. ▶ <b>Collision Mitigation Braking System (CMBS)</b> P. 484	<b>Far/Normal*<sup>1</sup>/Near</b>
<b>Head-up warning*</b>	Turn On/Off warning light for head-up flash alert.	<b>ON*<sup>1</sup>/OFF</b>
<b>Front cross traffic warning on Head-up display*</b>	Turn On/Off the front cross traffic warning on the head-up display.	<b>ON*<sup>1</sup>/OFF</b>
<b>ACC cornering speed</b>	Select the adaptive cruise control cornering speed.	<b>Slower/Average*<sup>1</sup>/Faster/Deceleration OFF</b>
<b>ACC vehicle ahead detected beep</b>	Turns On/Off audible notification when vehicle has moved in/out of Adaptive Cruise Control with Low Speed Follow range. ▶ <b>Adaptive Cruise Control (ACC) with Low Speed Follow</b> P. 526	<b>ON/OFF*<sup>1</sup></b>
<b>ACC cut-in prediction control</b>	Turns the ACC cut-in prediction control feature on and off. ▶ <b>Intelligent Adaptive Cruise Control Function</b> P. 548	<b>ON*<sup>1</sup>/OFF</b>

\*1:Default Setting

Customizable Features	Description	Selectable Settings
<b>Road departure mitigation setting</b>	Selects operating mode of the Road Departure Mitigation system. <input checked="" type="checkbox"/> <b>Road Departure Mitigation System</b> P. 510	<b>Early/Normal/Delayed</b> *1
<b>Lane keep assist beep</b>	Switches the LKAS and Traffic Jam Assist suspend alert beeps on and off. <input checked="" type="checkbox"/> <b>Lane Keeping Assist System (LKAS)</b> P. 550 <input checked="" type="checkbox"/> <b>Traffic Jam Assist</b> P. 561	<b>ON/OFF</b> *1
<b>Active lane change assist</b>	Select On/Off the active lane change assist.	<b>ON</b> *1/ <b>OFF</b>
<b>Lane change collision mitigation</b>	Select operating mode of lane change collision mitigation.	<b>Steering assist, audible and visual alert</b> *1/ <b>Audible and visual alert only/Visual alert only</b>
<b>Traffic sign recognition system display</b>	Displays the traffic sign recognition system on the instrument panel. <input checked="" type="checkbox"/> <b>Traffic Sign Recognition System</b> P. 576	<b>Display</b> *1/ <b>None</b>
<b>Speed limit sign change beep</b>	Turn on/off the audible notification when speed limit sign information is changed. <input checked="" type="checkbox"/> <b>Traffic Sign Recognition System</b> P. 576	<b>ON/OFF</b> *1

\*1:Default Setting

Customizable Features	Description	Selectable Settings
<b>Apply Parking Brake after Honda Parking Pilot</b>	Automatically applies the parking brake at the completion of a Honda Parking Pilot manoeuvre. ➤ <b>Honda Parking Pilot</b> P. 626	<b>ON*<sup>1</sup>/OFF</b>
<b>Honda Parking Pilot Space Detect Beep</b>	Turns on/off the audible notification when Honda Parking Pilot detects an available parking space. ➤ <b>Honda Parking Pilot</b> P. 626	<b>ON*<sup>1</sup>/OFF</b>
<b>Rear sensor setting</b>	Turns the rear parking sensor ON or OFF. This selection will also affect the rear Low Speed Braking Control if equipped. ➤ <b>Parking Sensor System</b> P. 602 ➤ <b>Low Speed Braking Control</b> P. 498	<b>ON*<sup>1</sup>/OFF</b>

\*1:Default Setting

■ **Meter/HUD setup**

Customizable Features	Description	Selectable Settings
<b>Warning message</b>	Selects whether to display the warning message. ➤ <b>Driver Information Interface Warning and Information Messages</b> P. 138	<b>ON/OFF*<sup>1</sup></b>
<b>Adjust outside temp. display</b>	Adjusts outside temperature reading by a few degrees. ➤ <b>Outside Temperature</b> P. 159	<b>-3°C ~ ±0°C*<sup>1</sup> ~ +3°C</b>
<b>Trip A reset timing</b>	Changes the timing to reset Trip A. ➤ <b>Range / Fuel / Trip Meter</b> P. 167 ➤ <b>Speed/Time/Trip Meter</b> P. 170	<b>When fully refueled/When charged/When ignition is turned OFF/Manual reset*<sup>1</sup></b>

\*1:Default Setting

Customizable Features	Description	Selectable Settings
<b>Trip B reset timing</b>	Changes the timing to reset Trip B. ➤ <b>Range / Fuel / Trip Meter</b> P. 167 ➤ <b>Speed/Time/Trip Meter</b> P. 170	<b>When fully refueled/When charged/When ignition is turned OFF/Manual reset<sup>*1</sup></b>
<b>Alarm volume control</b>	Changes volume level of all system warnings, door opening warning, and indicator.	<b>Max/Mid<sup>*1</sup>/Min</b>
<b>Reverse position alert tone</b>	Turns on/off the reverse alert sound.	<b>ON<sup>*1</sup>/OFF</b>
<b>Fuel efficiency backlight</b>	Turns the ambient meter feature on and off.	<b>ON<sup>*1</sup>/OFF</b>
<b>Turn by turn display</b>	Turns on/off the pop-up warning in the turn-by-turn navigation in the head-up display* or in meter display when HUD is off. ➤ <b>Turn-by-Turn Directions</b> P. 171	<b>ON<sup>*1</sup>/OFF</b>
<b>Speed/distance units</b>	Selects the trip computer units. ➤ <b>Speed/Distance Units</b> P. 175	<b>Left-hand Drive Type</b> <b>km/h · km<sup>*1</sup>/mph · miles</b> <b>Right-hand Drive Type</b> <b>km/h · km/mph · miles<sup>*1</sup></b>
<b>Rear seat reminder</b>	Turns the Rear Seat Reminder feature on and off.	<b>ON<sup>*1</sup>/OFF</b>

\*1:Default Setting

■ **Driving position setup**

Customizable Features	Description	Selectable Settings
<b>Memory position link</b>	Turns the driving position memory system on and off.	<b>ON*<sup>1</sup>/OFF</b>
<b>Seat Position Movement At Entry/Exit</b>	Moves the seat rearward when you get in/get out of the vehicle. Changes the setting for this feature.	<b>ON*<sup>1</sup>/OFF</b>

\*1:Default Setting

■ **Keyless access setup**

Customizable Features	Description	Selectable Settings
<b>Door unlock mode</b>	Changes which doors unlock when you grab the driver’s door handle.	<b>Driver door only*<sup>1</sup>/All doors</b>
<b>Keyless access light flash</b>	Causes some exterior lights to flash when you unlock/lock the doors.	<b>ON*<sup>1</sup>/OFF</b>

\*1:Default Setting

■ Lighting setup

Customizable Features	Description	Selectable Settings
<b>Adaptive driving beam</b>	Turns on/off adaptive driving beam function.	<b>ON<sup>*1</sup>/OFF</b>
<b>Interior light dimmer duration</b>	Selects the length of time the interior lights stay on after doors are closed. <input checked="" type="checkbox"/> <b>Interior Lights</b> P. 263	<b>60sec/30sec<sup>*1</sup>/15sec</b>
<b>Headlight auto OFF timer</b>	Selects the length of time the exterior lights stay on after you close the driver's door. <input checked="" type="checkbox"/> <b>Automatic Lighting Off Feature</b> P. 232	<b>60sec/30sec/15sec<sup>*1</sup>/0sec</b>
<b>Headlight integration with wipers</b>	Selects On/Off headlight function and wiper operation when the headlight is in <b>AUTO</b> setting. <input checked="" type="checkbox"/> <b>Headlight Integration with Wipers</b> P. 232	<b>ON<sup>*1</sup>/OFF</b>

\*1:Default Setting

### ■ Door/window setup

Customizable Features	Description	Selectable Settings
<b>Key and remote unlock mode</b>	Sets up either the driver's door or all doors to unlock on the first push of the keyless remote or built-in key.	<b>Driver door only</b> * <sup>1</sup> / <b>All doors</b>
<b>Lock presetting</b> *	Turns on/off the lock presetting function.	<b>ON</b> * <sup>1</sup> / <b>OFF</b>
<b>Keyless lock notification</b>	Turns on/off flash of exterior lights when doors are locked/unlocked by remote. <input checked="" type="checkbox"/> <b>Using the Remote Transmitter</b> P. 196	<b>ON</b> * <sup>1</sup> / <b>OFF</b>
<b>Auto folding door mirror</b>	Selects door mirror auto folding operation.	<b>ON</b> * <sup>1</sup> / <b>OFF</b>
<b>Remote Window Control</b>	Changes the settings for the remote window control function.	<b>ON</b> * <sup>1</sup> / <b>OFF</b>

\*1:Default Setting

### ■ Power tailgate setup

Customizable Features	Description	Selectable Settings
<b>Keyless open mode</b>	Changes the keyless setting for when the power tailgate opens.	<b>Anytime</b> * <sup>1</sup> / <b>When unlocked</b>
<b>Power open by outer handle</b>	Changes the setting to open power tailgate by tailgate outer handle.	<b>ON (Power/Manual)</b> * <sup>1</sup> / <b>OFF (Manual only)</b>
<b>Hands free access</b>	Changes the setting to open power tailgate by a swift forward in and out kicking motion under the rear bumper.	<b>ON</b> * <sup>1</sup> / <b>OFF</b>

\*1:Default Setting

■ **Predictive Eco Assist**

Customizable Features	Description	Selectable Settings
<b>Predictive Eco Assist</b>	Turns the Predictive Eco Assist on and off.	<b>ON*<sup>1</sup>/OFF</b>

\*1:Default Setting

■ **Engine oil level check reminder**

Customizable Features	Description	Selectable Settings
<b>Engine oil level check reminder</b>	Resets the engine oil level check reminder.	<b>Reset/Cancel</b>

■ **Maintenance info.\***

Customizable Features	Description	Selectable Settings
<b>Maintenance info.</b>	Resets the maintenance information. <input checked="" type="checkbox"/> <b>Service Reminder System</b> * P. 676	<b>Selects Reset Items</b>

\* Not available on all models

## Defaulting All the Settings

Reset all the menu and customized settings as the factory defaults.

### ■ Defaulting General Settings

1. Press the  button.
2. Select **General Settings**.
3. Select **System**.
4. Select **Factory Data Reset**.
  - A confirmation message appears on the screen.
5. Select **Continue**.
6. Select **Continue** again to reset the settings.
  - The system will reboot.

### ■ Defaulting Vehicle Settings

1. Press the  button.
2. Select **Vehicle Settings**.
3. Select **Default**.
4. Select **Yes**.

### » Defaulting All the Settings

When you transfer the vehicle to a third-party, reset all settings to default and delete all personal data.

If you perform **Factory Data Reset**, it will reset the preinstalled apps to their factory default.

## Hands-Free Telephone System

Hands-Free Telephone (HFT) system allows you to place and receive phone calls using your vehicle's audio system, without handling your mobile phone.

### HFT Buttons

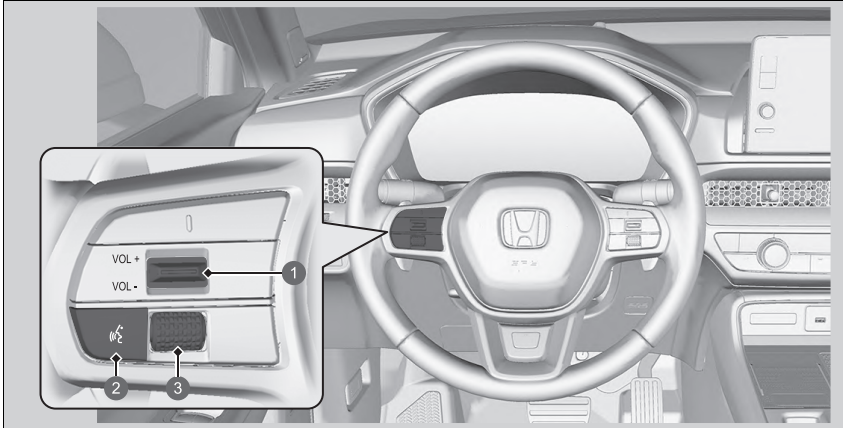

- ❶ VOL  $\oplus$ /VOL  $\ominus$  (Volume) Switch
- ❷  (Talk) Button
- ❸ Left Selector Wheel

### Hands-Free Telephone System

Place your phone where you can get good reception.

To use HFT, you need a *Bluetooth*-compatible mobile phone. For a list of compatible phones, pairing procedures, and special feature capabilities, ask a dealer or your local Honda.

To use the system, the **Bluetooth** setting must be **ON**.

➤ **Phone Setup** P. 386

Voice control tips

- Aim the vents away from the ceiling and close the windows, as noise coming from them may interfere with the microphones.
- Press the  button when you want to call a number using a phonebook name or a number. Speak clearly and naturally after a beep.
- If the microphone picks up voices other than yours, the command may be misinterpreted.
- To change the volume level, use the audio system's volume.

If there is no Favourite contacts entry in the system, the pop-up notification appears on the screen.

➤ **Favourite Contacts** P. 391

 **(Talk) button:** Press to access Voice Portal.

**Left Selector Wheel:** Roll up or down to select  (phone) on the driver information interface, and then press the left selector wheel.

While receiving a call, the incoming call screen is displayed on the driver information interface. You can pick up the call using the left selector wheel.

 **Receiving a Call** P. 395

#### Hands-Free Telephone System

##### *Bluetooth*® Wireless Technology

The *Bluetooth*® word mark and logos are registered trademarks owned by *Bluetooth* SIG, Inc., and any use of such marks by Honda Motor Co., Ltd., is under licence. Other trademarks and trade names are those of their respective owners.

##### HFT Limitations

An incoming call on HFT will interrupt the audio system when it is playing. It will resume when the call is ended.

## HFT Status Display

The audio/information screen notifies you when there is an incoming call.



- ❶ HFT Mode
- ❷ Caller's Name (If registered)/Caller's Number (If not registered)
- ❸ *Bluetooth*® Indicator  
Appears when your phone is connected to HFT.
- ❹ Signal Strength
- ❺ Battery Level Status

## HFT Status Display

The information that appears on the audio/information screen varies between phone models.

## ■ Limitations for Manual Operation

Certain manual functions are disabled or inoperable while the vehicle is in motion. You cannot select a greyed-out option until the vehicle is stopped.

Only previously stored phonebook names or numbers can be called using voice commands while the vehicle is in motion.

➤ **Favourite Contacts** P. 391

## HFT Menus

The power mode must be in ACCESSORY or ON to use the system. Select **Phone** to display the phone screen.



- ① Recent calls
- ② Favourite contacts
- ③ Settings
- ④ Contacts
- ⑤ Keypad

### HFT Menu

Some functions are limited while driving.

**Recent calls:** Displays the last outgoing, incoming, and missed calls.

➤ **To make a call using the recent calls** P. 393

**Favourite contacts:** Dials the selected number in the Favourite contacts entry.

➤ **To make a call using a Favourite contacts entry** P. 393

**Settings:** Changes the phone settings.

➤ **Phone Settings Screen** P. 385

**Contacts:** Displays the phonebook of the paired phone.

➤ **To make a call using the imported phonebook** P. 394

**Keypad:** Enters a phone number to dial.

➤ **To make a call using a phone number** P. 394

## Phone Settings Screen

To display the phone settings screen, select **Settings** on the phone screen.

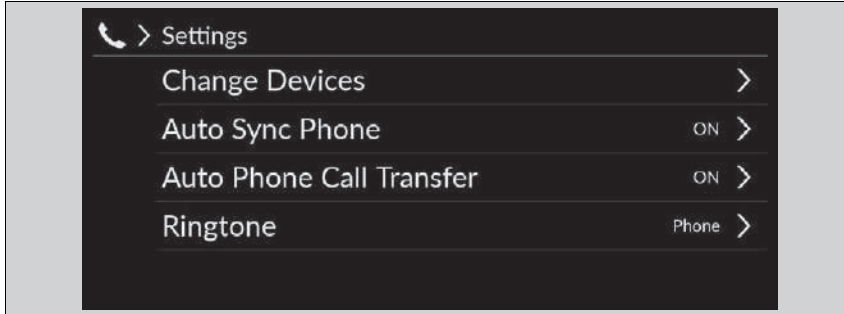

**Change Devices:** Pairs a new phone to the system and connect, disconnect, or delete a paired device.

➤ **Phone Setup** P. 386

**Auto Sync Phone:** Sets phonebook and recent calls data to be automatically imported when a phone is paired to HFT.

➤ **Automatic Import of Mobile Phonebook and Recent calls** P. 389

**Auto Phone Call Transfer:** Sets calls to automatically transfer from your phone to HFT when you enter the vehicle.

➤ **Automatic Transferring** P. 390

**Ringtone:** Selects the ringtone.

➤ **Ringtone** P. 390

## ■ Phone Setup

### ■ **Bluetooth® setup**

You can turn *Bluetooth®* function on and off.

1. Press the  button.
2. Select **General Settings**.
3. Select **Connections**.
4. Select **Bluetooth**.
5. Select **Options**.
6. Select **Bluetooth**, then select **ON**.

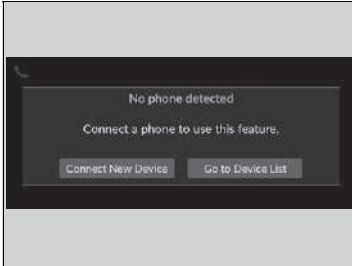

■ **To pair a mobile phone (when there is no phone paired to the system)**

1. Select **Phone**.
2. Select **Connect New Device**.
3. Make sure your phone is in search or discoverable mode.
4. Select **Honda HFT** from your phone.
  - ▶ If you want to pair a phone from this audio system, select **Search for Devices**, and then select your phone when it appears on the list.
5. The system gives you a pairing code on the audio/information screen.
  - ▶ Confirm if the pairing code on the screen and your phone matches.  
This may vary by a phone.
6. Select desired functions and then select **Connect**.
7. A notification appears on the screen if pairing is successful.
8. Select **OK**.



☒ Phone Setup

Your *Bluetooth*-compatible phone must be paired to the system before you can make and receive hands-free calls.

Phone Pairing Tips:

- You cannot pair your phone while the vehicle is moving.
- Up to six phones can be paired.
- Your phone's battery may drain faster when it is paired to the system.







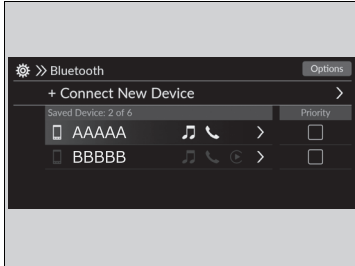

Once you have paired a phone, you can see it displayed on the screen with the following icons.

- : The phone is compatible with *Bluetooth*® Audio.
- : The phone can be used with HFT.
- : The phone is compatible with Apple CarPlay.

If there is an active connection to Apple CarPlay pairing of additional *Bluetooth*® compatible devices is unavailable.



### ■ To change the currently paired phone

1. Select **Phone**.
2. Select **Settings**.
3. Select **Change Devices**.
4. Select a phone to connect.
  - HFT disconnects the connected phone and starts searching for another paired phone.
  - You can set the connected phone priority. Select the box checked on the phone you want to prioritize.
5. Select  (audio),  (phone), or  (Apple CarPlay).
  -  and  can be selected simultaneously, however, when  is selected,  and  cannot be selected.
6. Select **Apply**.

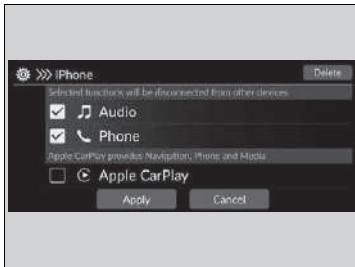

### ■ To delete a paired phone

1. Select **Phone**.
2. Select **Settings**.
3. Select **Change Devices**.
4. Select a phone you want to delete.
5. Select **Delete**.
6. A confirmation message appears on the screen. Select **Delete**.

### ►► To change the currently paired phone

If no other phones are found or paired when trying to switch to another phone, HFT will inform you that the original phone is connected again.

To pair other phones, select **+ Connect New Device** from the **Bluetooth** screen.

## Automatic Import of Mobile Phonebook and Recent calls









When your phone is paired, the contents of its phonebook and recent calls are automatically imported to the system.

1. Select **Phone**.
2. Select **Settings**.
3. Select **Auto Sync Phone**.
4. Select **ON** or **OFF**.
  - ▶ The default setting is **ON**.

### Automatic Import of Mobile Phonebook and Recent calls

On some phones, it is necessary to set up it enabled to be imported the mobile phonebook.

When you select a name from the list in the mobile phonebook, you can see a category icon. The icons indicate what types of numbers are stored for that name.

	Pref		Fax
	Home		Car
	Mobile		Voice
	Work		Other
	Pager		

On some phones, it may not be possible to import the category icons to the system.

The phonebook is updated after every connection. Recent calls are updated after every connection or call.

## ■ Automatic Transferring

If you get into the vehicle while you are on the phone, the call can be automatically transferred to HFT.

1. Select **Phone**.
2. Select **Settings**.
3. Select **Auto Phone Call Transfer**.
4. Select **ON** or **OFF**.
  - ▶ The default setting is **ON**.

## ■ Ringtone

You can change the ringtone setting.

1. Select **Phone**.
2. Select **Settings**.
3. Select **Ringtone**.
4. Select **Vehicle** or **Phone**.
  - ▶ The default setting is **Phone**.

### ⌘ Ringtone

**Vehicle:** The fixed ringtone sounds from the speakers.

**Phone:** Depending on the make and model of the mobile phone, the ringtone stored in the phone will sound if the phone is connected.

## Favourite Contacts

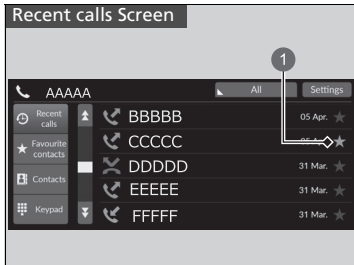

1 Star Icon

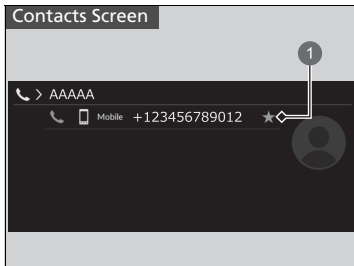

1 Star Icon

### ■ To add a Favourite contacts

1. Select **Phone**.
2. Select **Recent calls, Contacts, or Keypad**.

#### On the Recent calls or Contacts screen

3. Select the star icon.

#### On the Keypad screen

3. Select **Add to Favourite Contacts**.

- ▶ A notification appears on the screen if the Favourite contacts is successfully stored.
- ▶ To remove the Favourite contacts, select the star icon again.

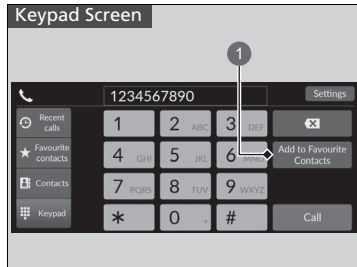

## 1 Add to Favourite Contacts

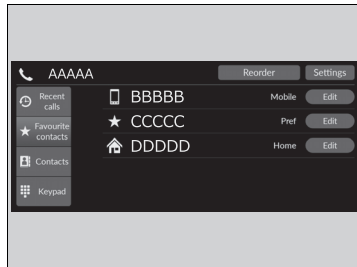

### ■ To edit a Favourite contacts

1. Select **Phone**.
2. Select **Favourite contacts**.
3. Select **Edit** on the Favourite contacts entry you want to edit.
4. Select a setting you want.
5. Select **Done**.

### ■ To delete a Favourite contacts

1. Select **Phone**.
2. Select **Favourite contacts**.
3. Select **Edit** on the Favourite contacts entry you want to delete.
4. Select **Remove**.
5. A confirmation message appears on the screen. Select **Yes**.

## Making a Call



You can make calls by inputting any phone number, or by using the imported **Recent calls**, **Favourite contacts**, and **Contacts** entries.

### ■ To make a call using the recent calls

Recent calls are stored by **All**, **Dialled**, **Missed**, and **Received**.

1. Select **Phone**.
2. Select **Recent calls**.
  - ▶ You can sort by **All**, **Dialled**, **Missed**, or **Received**. Select the icon on the upper right of the screen.
3. Select a number.
  - ▶ Dialling starts automatically.

### ■ To make a call using a Favourite contacts entry

1. Select **Phone**.
2. Select **Favourite contacts**.
  - ▶ You can change the order of Favourite contacts entries by selecting **Reorder**.
3. Select a number.
  - ▶ Dialling starts automatically.

### ☒ Making a Call

Once a call is connected, you can hear the voice of the person you are calling through the audio speakers.

While there is an active connection with Apple CarPlay, phone calls cannot be made with Hands-Free Telephone (HFT) system and are only made from Apple CarPlay.

### ☒ To make a call using the recent calls

The recent calls appear only when a phone is connected to the system.

- All:** Displays the last outgoing, incoming, and missed calls.
- Dialled:** Displays the last outgoing calls.
- Missed:** Displays the last missed calls.
- Received:** Displays the last incoming calls.

### ■ To make a call using the imported phonebook

1. Select **Phone**.
2. Select **Contacts**.
3. Select a name.
  - ▶ You can sort by **First Name** or **Surname**. Select the icon on the upper right of the screen.
4. Select a number.
  - ▶ Dialling starts automatically.

### ■ To make a call using a phone number

1. Select **Phone**.
2. Select **Keypad**.
3. Select a number.
  - ▶ Use the keyboard on the touch screen for entering numbers.
4. Select **Call**.
  - ▶ Dialling starts automatically.

## Receiving a Call

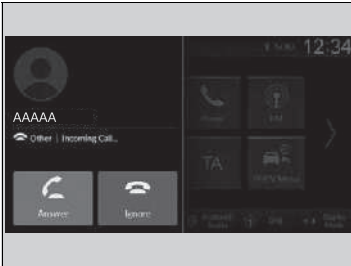

When there is an incoming call, an audible notification sounds (if activated) and the **Incoming Call...** screen appears.

You can answer the call using the left selector wheel.

To pick up the call, roll up or down to select  (answer) on the driver information interface and then press the left selector wheel.

- ▶ If you want to decline or end the call, select  (ignore) on the driver information interface using the left selector wheel.

## Receiving a Call



### Call Waiting

Select  (answer) to put the current call on hold to answer the incoming call.

Select  using the left selector wheel to return to the current call.

Select  (ignore) to ignore the incoming call if you do not want to answer it.

Select  if you want to hang up the current call.

You can select the icons on the audio/information screen instead of  and  on the driver information interface.

## ■ Options During a Call

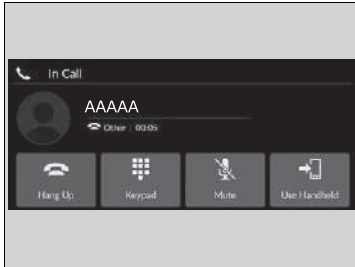

The following options are available during a call.

**Keypad:** Send numbers during a call. This is useful when you call a menu-driven phone system.

**Mute:** Mute your voice.

**Use Handheld:** Transfer a call from the system to your phone.

The available options are shown on the lower half of the screen.

Select the option.

- ▶ The mute icon appears when **Mute** is selected when the other source screen other than the phone screen is displayed. Select **Mute** again to turn it off.

## ▣ Options During a Call

You can select the icons on the audio/information screen.

## iPod/USB Flash Drive

If an error occurs while playing an iPod or USB flash drive, you may see the following error messages. If you cannot clear the error message, contact a dealer.

Error Message	Solution
<b>No response from device</b> <b>Connect Retry</b>	Appears when the system does not acknowledge the iPod. Reconnect the iPod.
<b>Unplayable File</b>	Appears when the files in the USB flash drive are copyright protected or an unsupported format. This error message appears for about five seconds, then plays the next song.
<b>No Data</b>	<b>iPod</b> Appears when the iPod is empty. <b>USB flash drive</b> Appears when the USB flash drive is empty or there are no MP3, WMA, AAC, FLAC, WAV, MP4, AVI, MKV, or ASF/WMV files in the USB flash drive. <b>iPod and USB flash drive</b> Check that compatible files are stored on the device.
<b>Unsupported Device</b>	Appears when the system does not communicate with a connected device. If it appears when a device is connected, contact your place of device purchase.
<b>USB hub not supported</b>	Appears when only a HUB is connected. If it appears, connect a USB flash drive to the HUB.
<b>A charging error has occurred with the connected USB device. When safe please check the compatibility of the device and USB cable and try again.</b>	Appears when an incompatible device is connected. Disconnect the device. Then turn the audio system off, and turn it on again. Do not reconnect the device that caused the error.

## Compatible iPod, iPhone, and USB Flash Drives

### iPod and iPhone Model Compatibility

Model
Made for iPod touch (5th to 6th generation) released between 2012 and 2015
Made for iPhone 5s/iPhone 5c/iPhone 6/iPhone 6 Plus/iPhone 6S/iPhone 6S Plus/iPhone SE/iPhone 7/iPhone 7 Plus/iPhone 8/iPhone 8 Plus/iPhone X/iPhone XS/iPhone XS Max/iPhone XR/iPhone 11/iPhone 11 Pro/iPhone 11 Pro Max/iPhone SE (2nd generation)/iPhone 12/iPhone 12 Pro/iPhone 12 Pro Max/iPhone 12 mini

### USB Flash Drives

- A USB flash drive of 256 MB or higher is recommended.
- Some digital audio players may not be compatible.
- Some USB flash drives (e.g., a device with security lockout) may not work.
- Some software files may not allow for audio play or text data display.
- Each audio system is compatible the following formats. Some versions of the formats may be unsupported.  
MP3, WMA, AAC, FLAC, PCM/WAVE, MP4, AVI, MKV, ASF/WMV

### » iPod and iPhone Model Compatibility

This system may not work with all software versions of these devices.

The Lightning connector works with iPhone 5s, iPhone 5c, iPhone 6, iPhone 6 Plus, iPhone 6S, iPhone 6S Plus, iPhone SE, iPhone 7, iPhone 7 Plus, iPhone 8, iPhone 8 Plus, iPhone X, iPhone XS, iPhone XS Max, iPhone XR, iPhone 11, iPhone 11 Pro, iPhone 11 Pro Max, iPhone SE (2nd generation), iPhone 12, iPhone 12 Pro, iPhone 12 Pro Max, iPhone 12 mini, iPod touch (5th, 6th generation).

USB works with iPhone 5s, iPhone 5c, iPhone 6, iPhone 6 Plus, iPhone 6S, iPhone 6S Plus, iPhone SE, iPhone 7, iPhone 7 Plus, iPhone 8, iPhone 8 Plus, iPhone X, iPhone XS, iPhone XS Max, iPhone XR, iPhone 11, iPhone 11 Pro, iPhone 11 Pro Max, iPhone SE (2nd generation), iPhone 12, iPhone 12 Pro, iPhone 12 Pro Max, iPhone 12 mini, iPod touch (5th, 6th generation).

### » USB Flash Drives

Files on the USB flash drive are played in their stored order. This order may be different from the order displayed on your PC or device.

## ■ Recommended Devices

### ■ MP4 File

Media	USB Flash Drive	
<b>Profile (MP4 version)</b>	BaselineProfile/Level 3, MainProfile/Level 3.1 (MPEG4-AVC)	SimpleProfile/Level 5 (MPEG4)
<b>File extension (MP4 version)</b>	.mp4/.m4v	
<b>Compatible audio codec</b>	AAC, MP3	
<b>Compatible video codec</b>	MPEG4-AVC (H.264)	MPEG4 (ISO/IEC 14496 Part.2)
<b>Bit rate</b>	10 Mbps, 14 Mbps (MPEG4-AVC)	8 Mbps (MPEG4)
<b>Maximum image</b>	1,280 × 720 pixels (MPEG4-AVC)	720 × 576 pixels (MPEG4)

### ■ AVI File

Media	USB Flash Drive		
<b>Profile (AVI version)</b>	BaselineProfile/Level 3, MainProfile/Level 3.1 (MPEG4-AVC)	SimpleProfile/Level 5 (MPEG4)	AdvancedProfile/Level 2, MainProfile/Level Medium, SimpleProfile/Level Medium (VC-1)
<b>File extension (AVI version)</b>	.avi		
<b>Compatible audio codec</b>	AAC, MP3, WMA		
<b>Compatible video codec</b>	MPEG4-AVC (H.264)	MPEG4 (ISO/IEC 14496 Part.2)	VC-1
<b>Bit rate</b>	10 Mbps, 14 Mbps (MPEG4-AVC)	8 Mbps (MPEG4)	20 Mbps, 10 Mbps, 384 kbps (VC-1)
<b>Maximum image</b>	1,280 × 720 pixels (MPEG4-AVC)	720 × 576 pixels (MPEG4)	1,280 × 720 pixels, 720 × 480 pixels, 352 × 288 pixels (VC-1)

■ MKV File

Media		USB Flash Drive	
<b>Profile (MKV version)</b>	BaselineProfile/Level 3, MainProfile/Level 3.1 (MPEG4-AVC)	SimpleProfile/Level 5 (MPEG4)	AdvancedProfile/Level 2, MainProfile/Level Medium, SimpleProfile/Level Medium (VC-1)
<b>File extension (MKV version)</b>	.mkv		
<b>Compatible audio codec</b>	AAC, MP3		
<b>Compatible video codec</b>	MPEG4-AVC (H.264)	MPEG4 (ISO/IEC 14496 Part.2)	VC-1
<b>Bit rate</b>	10 Mbps, 14 Mbps (MPEG4-AVC)	8 Mbps (MPEG4)	20 Mbps, 10 Mbps, 384 kbps (VC-1)
<b>Maximum image</b>	1,280 × 720 pixels (MPEG4-AVC)	720 × 576 pixels (MPEG4)	1,280 × 720 pixels, 720 × 480 pixels, 352 × 288 pixels (VC-1)

■ ASF/WMV File

Media		USB Flash Drive	
<b>Profile (ASF/WMV version)</b>	BaselineProfile/Level 3, MainProfile/Level 3.1 (MPEG4-AVC)	AdvancedProfile/Level 2, MainProfile/Level Medium, SimpleProfile/Level Medium (VC-1)	
<b>File extension (ASF/WMV version)</b>	.asf/.wmv		
<b>Compatible audio codec</b>	WMA		
<b>Compatible video codec</b>	MPEG4-AVC (H.264)		VC-1
<b>Bit rate</b>	10 Mbps, 14 Mbps (MPEG4-AVC)		20 Mbps, 10 Mbps, 384 kbps (VC-1)
<b>Maximum image</b>	1,280 × 720 pixels (MPEG4-AVC)		1,280 × 720 pixels, 720 × 480 pixels, 352 × 288 pixels (VC-1)

## About Open Source Licences

---

To see the open source licence information, follow these steps.

1. Press the  button.
2. Select **General Settings**.
3. Select **System**.
4. Select **About**.
5. Select **Legal Information**.
6. Select **Licence**.

## Licence Information

---

### ■ Bluetooth

The *Bluetooth*® word mark and logos are registered trademarks owned by Bluetooth SIG, Inc. and any use of such marks by Panasonic Automotive Systems Co., Ltd. is under license. Other trademarks and trade names are those of their respective owners.

*<https://www.bluetooth.com/develop-with-bluetooth/marketing-branding/>*



### ■ Windows Media

This product is protected by certain intellectual property rights of Microsoft. Use or distribution of such technology outside of this product is prohibited without a license from Microsoft.

## ■ Apple

“Made for iPod,” and “Made for iPhone,” mean that an electronic accessory has been designed to connect specifically to iPod, or iPhone, respectively, and has been certified by the developer to meet Apple performance standards. Apple is not responsible for the operation of this device or its compliance with safety and regulatory standards. Please note that the use of this accessory with iPod, or iPhone, may affect wireless performance.

Apple, the Apple Logo, iPhone, iPod touch are trademarks of Apple Inc., registered in the U.S. and other countries. Apple CarPlay, iPod, iPhone, iTunes, Siri and Lightning are trademarks of Apple Inc. App Store is a service mark of Apple Inc.



## ■ MPEG

### Mpeg4 Visual

THIS PRODUCT IS LICENSED UNDER THE MPEG-4 VISUAL PATENT PORTFOLIO LICENSE FOR THE PERSONAL AND NON-COMMERCIAL USE OF A CONSUMER FOR (i) ENCODING VIDEO IN COMPLIANCE WITH THE MPEG-4 VISUAL STANDARD ("MPEG-4 VIDEO") AND/OR (ii) DECODING MPEG-4 VIDEO THAT WAS ENCODED BY A CONSUMER ENGAGED IN A PERSONAL AND NONCOMMERCIAL ACTIVITY AND/OR WAS OBTAINED FROM A VIDEO PROVIDER LICENSED BY MPEG LA TO PROVIDE MPEG-4 VIDEO. NO LICENSE IS GRANTED OR SHALL BE IMPLIED FOR ANY OTHER USE. ADDITIONAL INFORMATION INCLUDING THAT RELATING TO PROMOTIONAL, INTERNAL AND COMMERCIAL USES AND LICENSING MAY BE OBTAINED FROM MPEG LA, LLC. SEE [HTTP://WWW.MPEGLA.COM](http://www.mpegla.com).

### VC-1

THIS PRODUCT IS LICENSED UNDER THE VC-1 PATENT PORTFOLIO LICENSE FOR THE PERSONAL AND NON-COMMERCIAL USE OF A CONSUMER TO (i) ENCODE VIDEO IN COMPLIANCE WITH THE VC-1 STANDARD ("VC-1 VIDEO") AND/OR (ii) DECODE VC-1 VIDEO THAT WAS ENCODED BY A CONSUMER ENGAGED IN A PERSONAL AND NON-COMMERCIAL ACTIVITY AND/OR WAS OBTAINED FROM A VIDEO PROVIDER LICENSED TO PROVIDE VC-1 VIDEO. NO LICENSE IS GRANTED OR SHALL BE IMPLIED FOR ANY OTHER USE. ADDITIONAL INFORMATION MAY BE OBTAINED FROM MPEG LA, L.L.C. SEE [HTTP://WWW.MPEGLA.COM](http://www.mpegla.com).

#### AVC/H.264

THIS PRODUCT IS LICENSED UNDER THE AVC PATENT PORTFOLIO LICENSE FOR THE PERSONAL AND NONCOMMERCIAL USE OF A CONSUMER TO (i) ENCODE VIDEO IN COMPLIANCE WITH THE AVC STANDARD (“AVC VIDEO”) AND/OR (ii) DECODE AVC VIDEO THAT WAS ENCODED BY A CONSUMER ENGAGED IN A PERSONAL AND NON-COMMERCIAL ACTIVITY AND/OR WAS OBTAINED FROM A VIDEO PROVIDER LICENSED TO PROVIDE AVC VIDEO. NO LICENSE IS GRANTED OR SHALL BE IMPLIED FOR ANY OTHER USE.

ADDITIONAL INFORMATION MAY BE OBTAINED FROM MPEG LA, L.L.C. SEE [HTTP://WWW.MPEGLA.COM](http://www.mpegla.com).

## Legal Information on Apple CarPlay/Android Auto

---

### ■ OWNER'S MANUAL LICENSE/LIABILITY STATEMENTS

USE OF APPLE CARPLAY IS SUBJECT TO YOUR AGREEMENT TO THE CARPLAY TERMS OF USE, WHICH ARE INCLUDED AS PART OF THE APPLE iOS TERMS OF USE. IN SUMMARY, THE CARPLAY TERMS OF USE DISCLAIM APPLE AND ITS SERVICE PROVIDERS' LIABILITY IF THE SERVICES FAIL TO PERFORM CORRECTLY OR ARE DISCONTINUED, STRICTLY LIMIT APPLE AND ITS SERVICE PROVIDERS' OTHER LIABILITIES, DESCRIBE THE KINDS OF USER INFORMATION (INCLUDING, FOR EXAMPLE, VEHICLE LOCATION, VEHICLE SPEED, AND VEHICLE STATUS) BEING GATHERED AND STORED BY APPLE AND ITS SERVICE PROVIDERS, AND DISCLOSE CERTAIN POSSIBLE RISKS ASSOCIATED WITH THE USE OF CARPLAY, INCLUDING THE POTENTIAL FOR DRIVER DISTRACTION. SEE APPLE'S PRIVACY POLICY FOR DETAILS REGARDING APPLE'S USE AND HANDLING OF DATA UPLOADED BY CARPLAY.

USE OF ANDROID AUTO IS SUBJECT TO YOUR AGREEMENT TO THE ANDROID AUTO TERMS OF USE WHICH MUST BE AGREED TO WHEN THE ANDROID AUTO APPLICATION IS DOWNLOADED TO YOUR ANDROID PHONE. IN SUMMARY, THE ANDROID AUTO TERMS OF USE DISCLAIM GOOGLE AND ITS SERVICE PROVIDERS' LIABILITY IF THE SERVICES FAIL TO PERFORM CORRECTLY OR ARE DISCONTINUED, STRICTLY LIMIT GOOGLE AND ITS SERVICE PROVIDERS' OTHER LIABILITIES, DESCRIBE THE KINDS OF USER INFORMATION (INCLUDING, FOR EXAMPLE, VEHICLE LOCATION, VEHICLE SPEED, AND VEHICLE STATUS) BEING GATHERED AND STORED BY GOOGLE AND ITS SERVICE PROVIDERS, AND DISCLOSE CERTAIN POSSIBLE RISKS ASSOCIATED WITH THE USE OF ANDROID AUTO, INCLUDING THE POTENTIAL FOR DRIVER DISTRACTION. SEE GOOGLE'S PRIVACY POLICY FOR DETAILS REGARDING GOOGLE'S USE AND HANDLING OF DATA UPLOADED BY ANDROID AUTO.

## DISCLAIMER OF WARRANTIES; LIMITATION ON LIABILITY

YOU EXPRESSLY ACKNOWLEDGE AND AGREE THAT USE OF APPLE CARPLAY OR ANDROID AUTO (“THE APPLICATIONS”) IS AT YOUR SOLE RISK AND THAT THE ENTIRE RISK AS TO SATISFACTORY QUALITY, PERFORMANCE, ACCURACY AND EFFORT IS WITH YOU TO THE MAXIMUM EXTENT PERMITTED BY APPLICABLE LAW, AND THAT THE APPLICATIONS AND INFORMATION ON THE APPLICATIONS IS PROVIDED “AS IS” AND “AS AVAILABLE,” WITH ALL FAULTS AND WITHOUT WARRANTY OF ANY KIND, AND HONDA HEREBY DISCLAIMS ALL WARRANTIES AND CONDITIONS WITH RESPECT TO THE APPLICATIONS AND INFORMATION ON THE APPLICATIONS, EITHER EXPRESS, IMPLIED OR STATUTORY, INCLUDING, BUT NOT LIMITED TO, THE IMPLIED WARRANTIES AND/OR CONDITIONS OF MERCHANTABILITY, SATISFACTORY QUALITY, FITNESS FOR A PARTICULAR PURPOSE, ACCURACY, QUIET ENJOYMENT, AND NON-INFRINGEMENT OF THIRD PARTY RIGHTS. NO ORAL OR WRITTEN INFORMATION OR ADVICE GIVEN BY HONDA OR AN AUTHORISED REPRESENTATIVE SHALL CREATE A WARRANTY. AS EXAMPLES, AND WITHOUT LIMITATION, HONDA DISCLAIMS ANY WARRANTY REGARDING THE ACCURACY OF DATA PROVIDED BY THE APPLICATIONS, SUCH AS THE ACCURACY OF DIRECTIONS, ESTIMATED TRAVEL TIME, SPEED LIMITS, ROAD CONDITIONS, NEWS, WEATHER, TRAFFIC, OR OTHER CONTENT PROVIDED BY APPLE, GOOGLE, THEIR AFFILIATES, OR THIRD PARTY PROVIDERS; HONDA DOES NOT GUARANTEE AGAINST LOSS OF APPLICATION DATA, WHICH MAY BE LOST AT ANY TIME; HONDA DOES NOT GUARANTEE THAT THE APPLICATIONS OR ANY SERVICES PROVIDED THROUGH THEM WILL BE PROVIDED AT ALL TIMES OR THAT ANY OR ALL SERVICES WILL BE AVAILABLE AT ANY PARTICULAR TIME OR LOCATION. FOR EXAMPLE, SERVICES MAY BE SUSPENDED OR INTERRUPTED WITHOUT NOTICE FOR REPAIR, MAINTENANCE, SECURITY FIXES, UPDATES, ETC., SERVICES MAY BE UNAVAILABLE IN YOUR AREA OR LOCATION, ETC. IN ADDITION, YOU UNDERSTAND THAT CHANGES IN THIRD PARTY TECHNOLOGY OR GOVERNMENT REGULATION MAY RENDER THE SERVICES AND/OR APPLICATIONS OBSOLETE AND/OR UNUSABLE.

TO THE EXTENT NOT PROHIBITED BY LAW, IN NO EVENT SHALL HONDA OR ITS AFFILIATES BE LIABLE FOR PERSONAL INJURY, OR ANY INCIDENTAL, SPECIAL, INDIRECT OR CONSEQUENTIAL DAMAGES WHATSOEVER, INCLUDING, WITHOUT LIMITATION, DAMAGES FOR LOSS OF PROFITS, CORRUPTION OR LOSS OF DATA, FAILURE TO TRANSMIT OR RECEIVE ANY DATA, BUSINESS INTERRUPTION OR ANY OTHER COMMERCIAL DAMAGES OR LOSSES, ARISING OUT OF OR RELATED TO THE APPLICATIONS OR YOUR USE OF OR INABILITY TO USE THE APPLICATIONS OR INFORMATION ON THE APPLICATIONS, HOWEVER CAUSED, REGARDLESS OF THE THEORY OF LIABILITY (CONTRACT, TORT OR OTHERWISE) AND EVEN IF HONDA WERE ADVISED OF THE POSSIBILITY OF SUCH DAMAGES. SOME REGIONS AND JURISDICTIONS MAY DISALLOW THE EXCLUSION OR LIMITATION OF LIABILITY FOR DAMAGES, SO THESE LIMITATIONS AND EXCLUSIONS MAY NOT APPLY TO YOU. THE FOREGOING LIMITATIONS WILL APPLY EVEN IF THE ABOVE STATED REMEDY FAILS OF ITS ESSENTIAL PURPOSE.

## Automatic emergency call

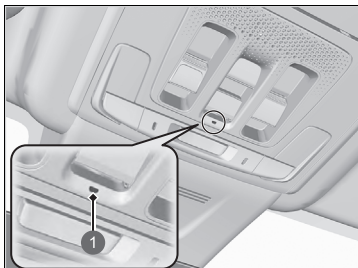

### 1 eCall Indicator

- Vehicle identification number (VIN)
- Type of vehicle (passenger vehicle or light-weight commercial vehicle)
- Type of energy stored for vehicle propulsion (gasoline/diesel/CNG/LPG/electricity/hydrogen)
- Last three locations of the vehicle
- Direction of travel
- Triggering mode (automatic or manual)
- Timestamp

When an emergency call is initiated, the vehicle speakers are disabled so that you can hear the operator.

When the power mode is set to ON, the eCall indicator lights up in green for 1 second, then in red for 1 second.

### Emergency Call (eCall)

Your vehicle is equipped with the 112-based eCall service system.

The 112-based eCall service is a public service of general interest and is accessible free of charge.

The 112-based eCall in-vehicle system is activated when the power mode is set to ON. In the event of a collision, the system will determine the degree of the impact based on information collected from the on-board sensors and, depending on the severity of the collision, will initiate the emergency call.

The 112-based eCall in-vehicle system can also be triggered manually, if needed.

➤ **Manual emergency call** P. 410

Any processing of personal data through the 112-based eCall in-vehicle system shall comply with the personal data protection rules provided for in Directives 95/46/EC (replaced by 2016/679/EC) and 2002/58/EC, and in particular, shall be based on the necessity to protect the vital interests of the individuals in accordance with Article 7(d) of Directive 95/46/EC (replaced by 2016/679/EC).

Processing of such data is strictly limited to the purpose of for which the single European emergency number 112 is designated.

If the eCall system is working properly, the indicator will light up in green.

- Green: eCall system is ready.
- Blinking in green: eCall system is connected and making an eCall to a PSAP operator.
- Repeating a pattern of short flashes of the red light: The eCall system has failed to connect to an operator. The eCall indicator will continue this pattern for 5 seconds, then it will light up in green.

If the 112-based eCall system is disabled in the event of a critical system failure, the following warning will be given to the occupants of the vehicle:

- Red or blacked out: A problem with the eCall system has occurred. If the indicator stays red or blacked out even after you have restarted the vehicle, have the system check by a dealer.
- Blinking in red: The level of the backup battery is too low. While the power is in ON, the battery undergoes recharging. Once the battery has been recharged to a certain level, the eCall indicator lights up in green.

#### ☒ Emergency Call (eCall)

Recipients of data processed by the 112-based eCall in-vehicle system are the relevant public safety answering points designated by the respective public authorities of the country in which they are located and are the first to receive and for which the single European emergency number 112 is designated.

Your vehicle may NOT be able to connect to a PSAP operator if:

- both the 12V battery and backup battery are too low.
- your vehicle is in an area without adequate cellular coverage (including when the 2G/3G network is out of service).
- There is a problem with the eCall system itself or its peripheral equipment such as the microphone or speakers.

## Manual emergency call

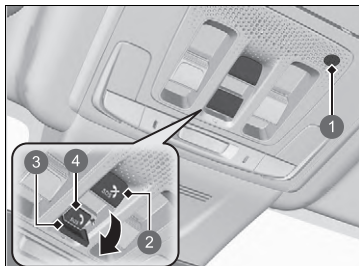

- ① Microphone
- ② **SOS** Cancel Button
- ③ Cover
- ④ **SOS** Button

The **SOS** button is protected by a cover. Open the cover to gain access.

When an emergency call is initiated, the vehicle speakers are disabled so that you can hear the operator.

### Manual emergency call

Do NOT press the button while you are driving. If you need to contact an operator, park the vehicle in a safe place before you make a call.

If the eCall system at first fails to connect to a PSAP operator, it will try again until a connection is established. However, if 2 minutes have elapsed since the first try was attempted, the system will no longer attempt to establish a connection.

The **SOS** cancel button does not cancel a call once the system is connected to an operator.

## Emergency Call (eCall) Unit Backup Battery Information

The backup battery is designed to operate for at least 3 years, after which it may need to be replaced.

The backup battery is not available for direct purchase. For replacement, visit a dealer.

### CAUTION

Risk of explosion if the battery is replaced by an incorrect type.

Replace battery with the same type.

### CAUTION

Risk of explosion or the leakage of flammable liquid or gas.

Do not use in/store in/bring into environment of extremely high temperature or extremely low pressure due to the very high altitude.

Do not attempt to burn, crush, or cut used battery.

Manufacturer information for the backup battery: DENSO CORPORATION

Trade name: DENSO

Postal address: 1-1, Showa-cho, Kariya-shi, Aichi-ken, 448-8661, Japan

## Emergency Call (eCall)

### Data privacy

The 112-based eCall in-vehicle system is designed to ensure that:

- Data contained in the system memory is not available outside the system before an eCall is triggered.
- It is not traceable or subject to any constant tracking during its normal operation status.
- Data in the internal memory of the system is automatically and continuously removed.

For the system to function normally, the vehicle location data is constantly overwritten in the internal memory of the system so that the last three locations of the vehicle are kept up-to-date.

The log of activity data in the 112-based eCall in-vehicle system is kept for no longer than necessary for attaining the purpose of handling the emergency eCall and in any case not beyond 13 hours from the moment an emergency eCall was initiated.

## Emergency Call (eCall)

### Owner's rights

The data subject (the vehicle's owner) has a right of access to data and as appropriate to request the rectification, erasure or blocking of data, concerning him or her, the processing of which does not comply with the provisions of Directive 95/46/EC (replaced by 2016/679/EC).

Any third-parties to whom the data have been disclosed have to be notified of such rectification, erasure or blocking carried out in compliance with this Directive, unless it proves impossible or involves a disproportionate effort.

The data subject has a right to complain to the competent data protection authority if he or she considers that his or her rights have been infringed as a result of the processing of his or her personal data.

#### Honda eCall Service Information:

If you have any questions about eCall, contact the office relevant to the country in which you reside. See the service book or your local Honda website for a list of offices.

Your vehicle is equipped with a feature that automatically calculates when to refuel. This feature will notify you when refueling is recommended as well as enable you to search for petrol stations that are located in the vicinity of your vehicle.



1 Notification Icon

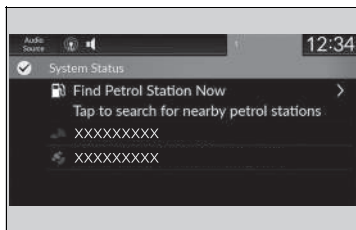

1. When it is time to refuel the vehicle, a notification is displayed and a notification icon is displayed in the header.
2. Touch the box that contains the icon.

3. Select **Find Petrol Station Now**.

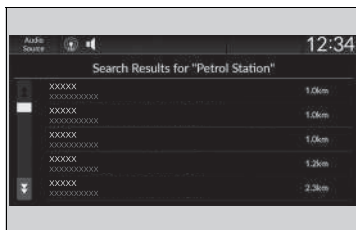

4. Choose a petrol station from the search screen of the navigation system.
  - ▶ For instructions on how to use the navigation system, refer to the navigation system manual.

## Refuel Recommend

You can turn the **Refuel Recommend** function on and off.

▶ **Customized Features** P. 360

When you turn off this feature, the refuel recommend notification will not display.

This feature can only be used when the fuel level in the tank is below 30 percent.

If you select **Find Petrol Station Now** or put more than 5 litres of petrol into the fuel tank, the notification for refueling will disappear. If you prefer not to be notified, select **OFF** in the settings for **Refuel Recommend**.

When you drive on a rough road or ascend or descend a hill for an extended period of time, the notification may disappear or may not be displayed at all.



# Driving

This chapter discusses driving and refueling.



<b>Before Driving</b> .....	416
<b>Towing a Trailer</b> .....	420
<b>Off-road Guidelines</b> .....	426
<b>When Driving</b>	
Turning on the Power .....	428
Precautions While Driving.....	431
Transmission .....	433
Shifting .....	434
Deceleration Paddle Selector .....	440
Acoustic Vehicle Alerting System.....	444
Drive Mode Switch.....	445
Adaptive Damper System .....	451
Hill Descent Control System .....	452
Adjustable Speed Limiter.....	454

Intelligent Speed Limiter.....	460
Vehicle Stability Assist (VSA) System ....	466
Agile Handling Assist .....	468
Deflation Warning System.....	469
Blind Spot Information System .....	471
LaneWatch .....	475
Adjusting Headlight Distribution .....	478
<b>Honda SENSING 360</b> .....	479
Collision Mitigation Braking System (CMBS)...	484
Low Speed Braking Control.....	498
Front Cross Traffic Warning .....	504
Road Departure Mitigation System....	510
Lane Change Collision Mitigation.....	518
Adaptive Cruise Control (ACC) with Low Speed Follow .....	526

Lane Keeping Assist System (LKAS)....	550
Traffic Jam Assist .....	561
Active Lane Change Assist .....	570
Traffic Sign Recognition System .....	576
Front Sensor Camera .....	585
Radar Sensor .....	587
Sonar Sensors.....	589
<b>Braking</b> .....	590
<b>Parking Your Vehicle</b> .....	600
<b>Multi-View Camera</b> .....	612
<b>Honda Parking Pilot</b> .....	626
<b>Refueling</b> .....	651
<b>Charging</b> .....	654
<b>Fuel Economy and CO<sub>2</sub> Emissions</b> ....	669

## Driving Preparation

Check the following items before you start driving.

### Exterior Checks

- Make sure there are no obstructions on the windows, door mirrors, exterior lights, or other parts of the vehicle.
  - ▶ Remove any frost, snow, or ice.
  - ▶ Remove any snow on the roof, as this can slip down and obstruct your field of vision while driving or fall off and impact other road users. If frozen solid, remove ice once it has softened.
  - ▶ When removing ice from around the wheels, be sure not to damage the wheel or wheel components.
- Make sure the bonnet is securely closed.
  - ▶ If the bonnet opens while driving, your front view will be blocked.
- Make sure the tyres are in good condition.
  - ▶ Check air pressures, and check for damage and excessive wear.
    - 🔧 **Checking and Maintaining Tyres** P. 710
- Make sure there are no people or objects behind or around the vehicle.
  - ▶ There are blind spots from the inside.
- Disconnect the charging cable.

### Exterior Checks

#### NOTICE

When doors are frozen shut, use warm water around the door edges to melt any ice. Do not try to force them open, as this can damage the rubber trim around the doors. When done, wipe dry to avoid further freezing.

Do not pour warm water into the key cylinder. You will be unable to insert the key if the water freezes in the hole.

Heat from the engine and exhaust can ignite flammable materials left under the bonnet, causing a fire. If you've parked your vehicle for an extended period, inspect and remove any debris that may have collected, such as dried grass and leaves that have fallen or have been carried in for use as a nest by a small animal. Also, check under the bonnet for leftover flammable materials after you or someone else has performed maintenance on your vehicle.

## Interior Checks

- Store or secure all items on board properly.
  - ▶ Carrying too much luggage, or improperly storing it, can affect your vehicle's handling, stability, stopping distance, and tyres, and make it unsafe.
    - **Load Limit** P. 419
- Do not pile items higher than the seatback height.
  - ▶ They can block your view and may be thrown forward in the event of sudden braking.
- Do not place anything in the front seat footwells. Make sure to secure the floor mat.
  - ▶ An object or unsecured floor mat can interfere with your brake and accelerator pedal operation while driving.
- If you have any animals on board, do not let them move around in the vehicle.
  - ▶ They may interfere with driving and a crash could occur.
- Securely close all doors and the tailgate.
- Adjust your seating position properly.
  - ▶ Adjust the head restraint, too.
    - **Seats** P. 251
    - **Adjusting the Front Head Restraint Positions** P. 259
- Adjust the mirrors and steering wheel properly.
  - ▶ Adjust them while sitting in the proper driving position.
    - **Mirrors** P. 248
    - **Adjusting the Steering Wheel** P. 247

### Interior Checks

The headlight aim is set by the factory, and does not need to be adjusted. However, if you regularly carry heavy items in the luggage area or tow a trailer, have the aiming readjusted at a dealer or by a qualified technician.

Your vehicle is equipped with the automatic headlight adjusting system that automatically adjusts the vertical angle of the low beam headlights.

- Be sure items placed on the floor behind the front seats cannot roll under the seats.
  - ▶ They can interfere with the driver's ability to operate the pedals, or the operation of the seats.
- Everyone in the vehicle must fasten their seat belt.
  - ▶ **Fastening a Seat Belt** P. 54
- Make sure that the indicators in the instrument panel come on when you start the vehicle, and go off soon after.
  - ▶ Always have a dealer check the vehicle if a problem is indicated.
    - ▶ **Indicators** P. 116

## Load Limit

When you load luggage, the total weight of the vehicle, all passengers, and luggage must not exceed the maximum permissible weight.

➤ **Specifications** P. 780

The load for the front and rear axles also must not exceed the maximum permissible axle weight.

➤ **Specifications** P. 780

### Load Limit

#### **⚠ WARNING**

Overloading or improper loading can affect handling and stability and cause a crash in which you can be hurt or killed.

Follow all load limits and other loading guidelines in this manual.

## Towing Preparation

### Towing Load Limits

Your vehicle can tow a trailer if you carefully observe the load limits, use the proper equipment, and follow the towing guidelines. Check the load limits before driving.

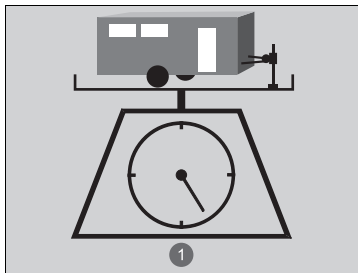

1 Total Load

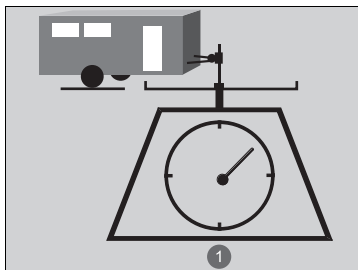

1 Trailer Nose Load

#### Total trailer weight

Do not exceed the maximum towing weight of the trailer and towbar (with/without brakes), luggage and everything in or on it. Towing loads in excess of the maximum towing weight can seriously affect vehicle handling and performance and can damage the power system and drivetrain.

#### Trailer nose load

The trailer nose load should never exceed 100 kg. This is the amount of weight the trailer puts on the towbar when it is fully-loaded. As a rule of thumb for trailer weights of less than 1,000 kg, the trailer nose load should be 10 percent of the total trailer package.

- Excessive trailer nose load reduces front tyre traction and steering control. Too little trailer nose load can make the trailer unstable and cause it to sway.
- To achieve a proper trailer nose load, start by loading 60% of the load toward the front of the trailer and 40% toward the rear. Readjust the load as needed.

### Towing Load Limits

## ⚠ WARNING

Exceeding any load limit or improperly loading your vehicle and trailer can cause a crash in which you can be seriously hurt or killed.

Check the loading of your vehicle and trailer carefully before starting to drive.

Check if all loads are within limits at a public scale. If a public scale is not available, add the estimated weight of your luggage load to the weight of your trailer (as quoted by the manufacturer), and the trailer nose load.

Break-in Period.

Avoid towing a trailer during your vehicle's first 1,000 km (600 miles).

When using a detachable towing device, always remove the towing device when not in use and only install it when towing so that it does not cover or hide anything on the rear of your vehicle, such as the exterior lights or licence plate.

Never exceed the maximum towing weight and specified load limit.

➤ **Specifications** P. 780

## ■ Towing Equipment and Accessories

Towing equipment varies by the size of your trailer, how much load you are towing, and where you are towing.

### ■ Towbars

The towbar must be of an approved type and properly bolted to the underbody.

### ■ Safety chains

Always use safety chains when you tow a trailer. Leave enough slack to allow the trailer to turn corners easily, but do not allow the chains to drag on the ground.

### ■ Trailer brakes

If you are thinking of getting a trailer that has brakes, be sure they are electronically actuated. Do not attempt to tap into your vehicle's hydraulic system. No matter how successful it may seem, any attempt to attach trailer brakes to your vehicle's hydraulic system will lower braking effectiveness and create a potential hazard.

### ■ Additional towing equipment

There may be laws requiring special outside mirrors when towing a trailer. Even if mirrors are not required in your locale, you should install special mirrors if visibility is restricted in any way.

#### ☒ Towing Load Limits

If you tow a trailer in mountainous conditions, remember to reduce 10% of the combined vehicle weights from the maximum towing weight for every 1,000 metres of elevation.

#### ☒ Towing Equipment and Accessories

Make sure that all equipment is properly installed and maintained, and that it meets the regulations of the country where you are driving.

Consult your trailer maker for proper installation and setup of the equipment.

Improper installation and setup can affect the electrical components, handling, stability, and braking performance of your vehicle.

Consult your trailer sales or rental agency if any other items are recommended or required for your towing situation.

The lighting and wiring of trailers can vary by type and brand. If a connector is required, it should only be installed by a qualified technician.

## ■ Trailer light

Trailer lights and equipment must comply with the regulations of the country where you are driving. Check with your local trailer sales or rental agency for the requirements in the area where you plan to tow.

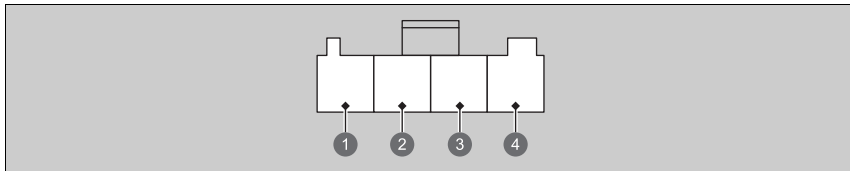

- ❶ Back-up Light (Light Green)
- ❷ +B Trailer (Light Violet/Red)
- ❸ Rear Fog Light (Brown)
- ❹ Small (Grey)

We recommend that you have a dealer install a Honda wiring harness and converter. They are designed for your vehicle.

The lighting and wiring of trailers can vary by type and brand. If a connector is required, it should only be installed by a qualified technician.

## ▶▶ Trailer light

The trailer lighting connector is located behind the left side panel in the luggage area. Even if you are planning to use the non-Honda trailer lighting harness and converter, ask a dealer for the correct connector and pins.

## Trailer Stability Assist

Helps to stabilize the vehicle and trailer when the trailer severely sways.

### ■ How trailer stability assist works

When the vehicle and trailer become unstable while driving, trailer stability assist determines the cause. If the trailer oscillation is detected as the cause, and the swaying increases, the system applies the brakes or controls power system output to reduce vehicle speed.

Both the vehicle and trailer brake lights come on automatically if you brake to reduce vehicle speed.

### ▶▶ Trailer Stability Assist

Trailer stability assist is not a function that prevents the vehicle and trailer from swaying. Avoid high speeds, abrupt steering, improper trailer load, and sudden braking to keep the trailer from swaying. When swayed too severely, the system becomes ineffective, and you may lose control of your vehicle, causing the trailer to roll over or get damaged.

▶ **Driving Safely with a Trailer** P. 424

Trailer towing sway is caused by:

- Crosswinds
- Improper towbar down load
- Excessive speed

The VSA system indicator blinks during the trailer stability assist operation.

▶ **VSA Operation** P. 466

## Driving Safely with a Trailer

### ■ Things You Need To Know Before Towing a Trailer

- Have the trailer properly serviced and keep it in good condition.
- Make sure that all the weights and load in the vehicle and trailer are within limits.
  - ✎ **Towing Load Limits** P. 420
- Securely attach the towbar, safety chains, and other necessary parts to the trailer.
- Securely store all the items in and on the trailer so that they do not shift while driving.
- Check if the lights and brakes on the trailer are working properly.
- Check the pressure of the trailer tyres, including the spare.
- Check regulations concerning the maximum speed or driving restrictions for vehicles towing trailers. If you are driving across several countries, check each country's requirements before leaving home, because regulations may vary.
- Turn off the rear parking sensor system. It may alert if it detects the towed object as an obstacle.
  - ✎ **How to Customize the Vehicle Settings** P. 368
- Turn off the rear Low Speed Braking Control system through the rear sensor setting. It may activate if it detects the towed object as an obstacle.
  - ✎ **How to Customize the Vehicle Settings** P. 368
- Select **TOW** mode for optimised transmission operation when towing a trailer.
  - ✎ **Drive Mode Switch** P. 445

### ■ Towing Speeds and Shift Position

- Drive slower than normal.
- Obey posted speed limits for vehicles with trailers.
- Use the **D** position when towing a trailer on level roads.

#### ►► Driving Safely with a Trailer

Operating speed when towing a trailer must not exceed 100 km/h (62 mph).

#### Parking

In addition to the normal precautions, place wheel chocks at each of the trailer's tyres.

Remember to unhitch the trailer before changing a flat tyre. Ask the trailer sales or rental agency where and how to store the trailer's spare tyre.

We recommend you drive uphill of less than 12% slope. Follow the trailer association's recommendations for suitable roads.

Winds caused by passing large vehicles can sway your trailer, keep a constant speed and steer straight ahead.

Always drive slowly and have someone guide you when reversing.



#### ►► Towing Speeds and Shift Position

When towing a fixed-sided trailer (e.g., camper), do not exceed 88 km/h (55 mph). At higher speeds, the trailer may sway or affect vehicle handling.

## ■ Turning and Braking

- Turn more slowly and with a wider turning arc than normal.
- Allow more time and distance for braking.
- Do not brake or turn suddenly.

## ■ Driving in Hilly Terrain

- If the  (white) **Engine temperature near limit. Avoid strong acceleration and high speed.** message appears on the driver information interface, turn off the climate control system and reduce speed.
- If the  (red) **Engine temperature too hot. Do not drive. Allow engine to cool.** message appears on the driver information interface, pull to the side of the road safely to cool down the engine.
- If the  **Power system temperature high. Power may be reduced.** message appears on the driver information interface, pull to the side of the road safely to cool down the power system.

## General Information

Your vehicle has been designed primarily for use on pavement; however, its higher ground clearance allows you to occasionally travel on unpaved roads. It is not designed for trail-blazing, or other challenging off-road activities.

If you decide to drive on unpaved roads, you will find that it requires somewhat different driving skills and that your vehicle will handle somewhat differently than it does on pavement. Pay attention to the precautions and tips in this section, and get acquainted with your vehicle before leaving the pavement.

## Important Safety Precautions

To avoid loss of control or rollover, be sure to follow all precautions and recommendations:

- Be sure to store luggage properly and do not exceed your luggage load limits.
  - **Load Limit** P. 419
- Whenever you drive, make sure you and your passengers always wear seat belts.
- Keep your speed low, and never go faster than the conditions allow.
- It's up to you to continually assess the situation and drive within the limits.

### Off-road Guidelines

## **WARNING**

Improperly operating this vehicle on or off-pavement can cause a crash or rollover in which you and your passengers could be seriously injured or killed.

- Follow all instructions and guidelines in this owner's manual.
- Keep your speed low, and don't drive faster than conditions permit.

Failure to operate your vehicle correctly might result in a crash or a rollover.

- **Important Handling Information** P. 46
- **Precautions While Driving** P. 431

## Avoiding Trouble

---

- **Check Out Your Vehicle** before you leave the pavement and make sure that all scheduled maintenance has been completed. Pay special attention to the condition of the tyres, and check the tyre pressures.
- **Remember** the route you choose presents limits (too steep or bumpy), you have limits (driving skill and comfort), and your vehicle has limits (traction, stability, and power). Failing to recognise these limits will likely put you and your passengers in a hazardous situation.
- **Accelerating and Braking** should be done slowly and gradually. Trying to start or stop too fast can cause a loss of traction and you could lose control.
- **Avoiding Obstacles and Debris** in the road reduces the likelihood of a rollover or damage to your suspension or other components.
- **Driving on Slopes** increases your risk of a rollover, particularly if you attempt to drive across a slope that is too steep. Going straight up or down a slope is usually the safest. If you can't clearly see all conditions or obstacles on a slope, walk it before you drive it. If there is any doubt whether you can safely pass, don't try it. Find another route. If you get stuck when climbing, do not try to turn around. Back down slowly following the same route you took up the hill.
- **Crossing a Stream** - Avoid driving through deep water. If you encounter water in your route (a small stream or large puddle, for example), evaluate it carefully before going ahead. Make sure it is shallow, flowing slowly, and has firm ground underneath. If you are not sure of the depth or the ground, turn around and find another route. Driving through deep water can also damage your vehicle. The water can get into the transmission and differential, diluting the lubricant and causing an eventual failure. It can also wash the grease out of the wheel bearings.
- **If You Get Stuck**, carefully go in the direction that you think will get you unstuck. Do not spin the tyres as this will only make things worse and could damage the transmission. If you are unable to free yourself, your vehicle will need to be towed. Front and rear tow hooks are provided for this purpose.

## Turning on the Power



1 Electric Parking Brake Switch

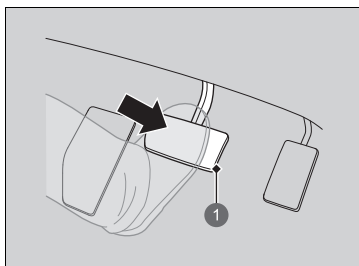

1 Brake Pedal

1. Make sure the parking brake is applied.
  - ▶ The parking brake and brake system indicator (red) comes on for 30 seconds when you pull up the electric parking brake switch.

2. Depress the brake pedal.

### Turning on the Power

Keep your foot firmly on the brake pedal when turning the power system on.

The engine is harder to start in cold weather and in thinner air found at altitudes above 2,400 metres (8,000 feet).

When turning on the power system in cold weather, turn off all electrical accessories such as the lights, climate control system, and rear demister in order to reduce the 12-volt battery drain.

If the exhaust system sounds abnormal or you can smell exhaust gas inside the vehicle, have your vehicle checked by a dealer. There may be a problem with the engine or exhaust system.

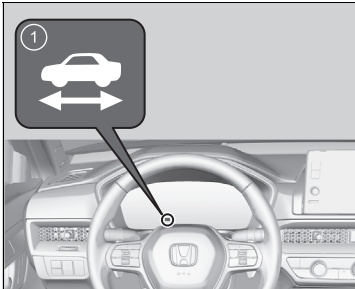
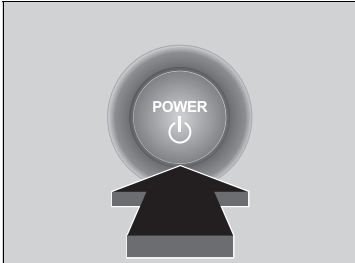

① (Ready) Indicator

3. Without depressing the accelerator pedal, press the **POWER** button while depressing the brake pedal.

4. Check the (Ready) indicator.

- ▶ Keep depressing the brake pedal until the indicator comes on.
- ▶ The indicator comes on when the power system is on and you can start driving.
- ▶ If the outside temperature is extremely low, you cannot drive until conditions are improved. In this case, the indicator does not come on and a warning message appears on the driver information interface.

▶ **Driver Information Interface Warning and Information Messages** P. 138

▶ Turning on the Power

Bring the keyless remote close to the **POWER** button if the battery in the keyless remote is weak.

▶ **If the Keyless Remote Battery is Weak**  
P. 750

The power system may not activate if the keyless remote is subjected to strong radio waves.

Do not hold the **POWER** button to start the power system. If the power system does not start, wait at least 30 seconds before trying again.

The engine may not run when the vehicle is ready for driving.

You can start driving with the indicator on. If you press the **POWER** button while depressing the brake pedal with the indicator on, the power mode is set to VEHICLE OFF and you cannot start driving.

▶ **Ready Indicator** P. 122

The immobilizer system protects your vehicle from theft.

If an improperly coded key (or other device) is used, the power system does not activate.

▶ **Immobilizer System** P. 213

When you set the power mode to ON, you may feel the brake pedal slightly sink down. This is normal.

## ■ Starting to Drive

1. Keeping your right foot on the brake pedal, check that the  indicator is on, then put the transmission into **[D]**. Select **[R]** when reversing.
2. With the parking brake applied, release the brake pedal and gently depress the accelerator pedal.
  - ▶ Make sure the parking brake and brake system indicator (red) goes off.
    - ❗ **Parking Brake** P. 590
    - ❗ **If the Transmission System Indicator Blinks along with the Warning Message** P. 762

## ■ Hill start assist system

Hill start assist keeps the brake engaged briefly to help to prevent the vehicle from rolling on inclines as you move your foot from the brake pedal to the accelerator.

Put the transmission into **[D]**, **[B]** when facing uphill, or **[R]** when facing downhill, then release the brake pedal.

## ■ Stopping the Power System

You can turn the power system off when the vehicle is completely stopped.

1. Depress the brake pedal and change the shift position to **[P]**.
  - ▶ Do not release the brake pedal until you have confirmed that **[P]** is shown on the shift position indicator.
2. Press the **POWER** button.

## ▶▶ Starting to Drive

You can also release the parking brake by pressing the electric parking brake switch while depressing the brake pedal. When facing downhill, you can start your vehicle more smoothly by manually releasing it with the electric parking brake switch than by releasing it with the accelerator pedal.

As a hybrid vehicle, the sounds and vibrations from the engine may be absent even though the vehicle is ready for driving. It also makes you fail to recognise that you can start. Make sure to check if the  indicator is on before you start to drive.

## ▶▶ Hill start assist system

Hill start assist may not prevent the vehicle from rolling downhill on a very steep or slippery slope, and will not operate on small inclines.

Hill start assist is not a replacement for the parking brake.

Hill start assist will operate even when VSA is switched off.

## Precautions While Driving

### ■ Driving Guidelines for Your Utility Vehicle

Utility vehicles have a significantly higher rollover rate than other types of vehicles. To prevent rollovers or loss of control:

- Take corners at slower speeds than you would with a passenger vehicle.
- Avoid sharp turns and abrupt manoeuvres whenever possible.
- Do not modify your vehicle in any way that you would raise the centre of gravity.
- Do not carry heavy luggage on the roof.

### ■ In a Fog

Visibility becomes low when it is foggy. When you drive, turn on the low beam headlights even during the daytime. Slow down, using the road line in the centre, guard rails, and the taillights of the vehicle ahead of you as your driving guide.

### ■ In a Strong Wind

If a strong side wind drifts your vehicle while driving, hold the steering wheel tight. Slowly decelerate your vehicle and keep your vehicle in the middle of the road. Be careful with wind gusts especially when your vehicle is exiting a tunnel, driving on a bridge or river bank, and driving through an open area like a quarry, and when a large lorry is passing by.

### ⊠ Precautions While Driving

**CAUTION:** Do not drive on the road where water is deep. Driving through deep water will cause damage to the engine and electrical equipment and the vehicle will break down.

#### NOTICE

Do not select a shift button while pressing the accelerator pedal. You could damage the transmission.

#### NOTICE

If you repeatedly turn the steering wheel at an extremely low speed, or hold the steering wheel in the full left or right position for a while, the electric power steering (EPS) system heats up. The system goes into a protective mode, and limits its performance. The steering wheel becomes harder and harder to operate. Once the system cools down, the EPS system is restored. Repeated operation under these conditions can eventually damage the system.

If the power mode is set to ACCESSORY while driving, the power system will shut down and all steering and brake power assist functions will stop, making it difficult to control the vehicle.

Do not select **N** while driving as you will lose regenerative braking (and acceleration) performance.

## ■ In Rain

The road is slippery when raining. Avoid hard braking, rapid acceleration, and abrupt steering and be more cautious when driving. It is likely to experience hydroplaning phenomenon if you are driving on a rutted road with puddles. Do not drive in deep water and on flooded roads. This can damage the engine or driveline, or cause electrical component failure.

## ■ Other Precautions

If there is a strong impact with something under the vehicle, stop in a safe location. Check the underside of the vehicle for damage or any fluid leaks.

## » Precautions While Driving

During the first 1,000 km (600 miles) of operation, avoid sudden acceleration or full throttle operation so as not to damage the engine or powertrain.

Avoid hard braking for the first 300 km (200 miles) after purchasing your new vehicle or replacing the brake pads or rotors, to allow for proper break-in.

## » Driving Guidelines for Your Utility Vehicle

Failure to operate your vehicle correctly might result in a crash or a rollover.

➤ **Important Handling Information P. 46**

## » In Rain

Be careful when hydroplaning phenomenon occurs. When you drive on a road covered with water at excessive speed, a layer of water builds between the tyres and the road surface. If this occurs, the vehicle cannot respond to control inputs such as steering, and braking.

Slowly decelerate when you increase the deceleration rate with the deceleration paddle selector. If the road is slippery, sudden regenerative braking can cause the tyres to skid.

## Transmission

---

### ■ Creeping

As with a conventional petrol-powered vehicle with an automatic transmission, this vehicle will creep.

Keep the brake pedal firmly depressed when stopped.

### ■ Kickdown

Quickly depressing the accelerator pedal while driving uphill may cause the vehicle to react similar to an automatic transmission vehicle, unexpectedly increasing vehicle speed. Depress the accelerator pedal carefully, especially on slippery roads and curves.

## Shifting

Change the shift position in accordance with your driving needs.

### ■ Shift button positions



#### **P** Parking

Used when parking or before turning the power on or off.

#### **R** Reverse

Used when reversing.

#### **N** Neutral

Transmission is not locked.

#### **D/B** Drive/B Position

Each time you press the **D/B** button, the mode switches between Drive and **B** Position mode.

##### Drive

- Used for normal driving.
- The deceleration paddle selector can be used temporarily.
- The deceleration paddle selector can be used when **SPORT** mode is ON.

##### **B** Position

- Used when driving down a long hill and to increase regenerative braking.
- The deceleration paddle selector can be used.

### ▶▶ Shifting

## ⚠ WARNING

The vehicle can roll away if left unattended without confirming that Park is engaged.

A vehicle that rolls away could cause a crash resulting in serious injury or death.

Always keep your foot on the brake pedal until you have confirmed that **P** is shown on the shift position indicator.

While the High Voltage battery level is full, or the High Voltage battery temperature is low, regenerative braking may become less effective.

To prevent malfunction and unintended engagement:

- Do not spill any liquids on or around shift buttons.
- Do not place or drop any objects on or around shift buttons.
- Do not let passengers or children operate the shift buttons.

The beeper sounds and the message appears on the driver information interface when you depress the accelerator pedal with the transmission in **N**.

#### ▶▶ Driver Information Interface Warning and Information Messages P. 138

Put the transmission into **D** or **R** with the brake pedal depressed.

## ■ **P** (parking) button

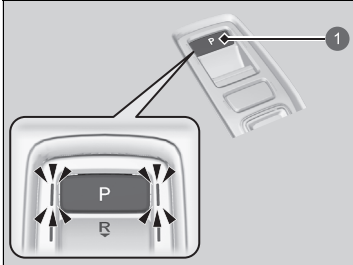

① **P** Button

The shift position changes to **P** when you press the **P** button while the vehicle is parked with the power mode in ON. The indicators on the sides of the **P** button come on.

## ☞ Shifting

You may occasionally find that it takes longer than usual for the vehicle to start moving when you select **R**, release the brake pedal, and/or depress the accelerator pedal. This may occur when the High Voltage battery level is extremely low, and does not indicate a vehicle malfunction.

## ■ Shift Operation



- ① Shift Position Indicator (Transmission System Indicator)
- ② Deceleration Paddle Selector Indicator

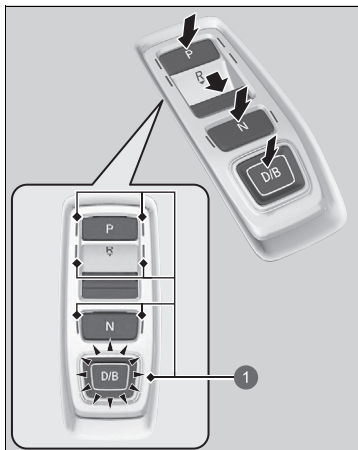

- ① Shift Button Indicator

**P**: Press the **P** button.

**R**: Press back the **R** button.

**N**: Press the **N** button.

**D/B**: Press the **D/B** button.

Each time you press the button, the mode switches between Drive and **B** Position mode.

## ▶▶ Shift Operation

### NOTICE

When you change **D** to **R** and vice versa, come to a complete stop and keep the brake pedal depressed. Operating the shift button before the vehicle has come to a complete standstill can damage the transmission.

When changing the shift position to **P**, always keep your foot on the brake pedal until you have confirmed that **P** is shown on the shift position indicator.

Use the shift position indicator and the shift button indicator to check the shift position before selecting a shift button.

If the indicator of the currently selected shift position, or all the shift position indicators are blinking simultaneously, there is a problem with the transmission.

Avoid sudden acceleration and have the transmission checked by a dealer as soon as possible.

The beeper sounds once when you change to **R**.

**▶▶ How to Customize the Vehicle Settings**  
P. 368

When shifting positions in extremely low temperatures (-30°C), there may be a short delay before the shift position is displayed. Always confirm you are in the correct shift position before driving.

**■ When opening the driver's door**

If you open the driver's door under the following conditions, the shift position automatically changes to **P**.

- ▶ If you manually change the shift position from **P** with the brake pedal depressed, the shift position will automatically return to **P** once you release the brake pedal.
- The vehicle is stationary with the power mode in ON, or moving at 2 km/h (1 mph) or slower.
- The transmission is in other than **P**.
- You have unfastened the driver side seat belt.

**■ When turning off the power mode**

If you turn the power system off while the vehicle is stationary, and the transmission is in other than **P**, the shift position automatically changes to **P**.

**ⓘ When opening the driver's door**

While the system is designed to automatically change the shift position to **P** under the described conditions, in the interest of safety you should always select **P** before opening the driver's door. Make sure to park the vehicle in a safe place.

**➤ When Stopped P. 600**

If you want to drive the vehicle after the shift position has automatically changed to **P** under the described conditions, close the door, fasten the seat belt, depress the brake pedal, then change the shift position.

If you leave the vehicle, turn off the power system and lock the doors.

■ **If you want to keep the transmission in **N** position (car wash mode)**

With the power system on:

1. Press and hold the brake pedal.
2. Select **N**.
3. Within five seconds, press the **POWER** button.  
The power mode changes to ACCESSORY and a message will be displayed on the driver information interface.
  - ▶ The shift position remains in **N** with the power mode in ACCESSORY for 15 minutes, then, it automatically changes to **P**.

Manually changing to **P** cancels ACCESSORY mode. The **P** indicator comes on and the power mode changes to OFF.



ⓘ If you want to keep the transmission in **N** position

Note that the transmission may not stay in **N** position while any of the following indicators is on:

- Power system indicator
- Transmission system indicator
- 12-volt battery charging system indicator

### ■ Restrictions on selecting a shift position

You cannot select a shift position under certain circumstances that may lead to a crash.

When the transmission is in:	1. Under these circumstances:	2. If you try to change to the following:	3. The shift position remains in/changes to:	How to change the shift position
<b>P</b>	The brake pedal is not depressed.	Other shift position	<b>P</b>	Release the accelerator pedal and depress the brake pedal.
	The accelerator pedal is depressed.			
<b>N</b>	The vehicle is moving at low speed without the brake pedal depressed.			
	The vehicle is moving at low speed with the accelerator pedal depressed.			
<b>N, D or B</b>	The vehicle is moving forward.	<b>R</b>	<b>N</b>	Park your vehicle in a safe place.
<b>R or N</b>	The vehicle is moving backward.	<b>D or B</b>		
<b>R, N, D or B</b>	The vehicle is moving.	<b>P</b>		
<b>P or N</b>	The  indicator is not on.	A shift position other than <b>P</b> or <b>N</b>	<b>P or N</b>	Make sure that the  indicator comes on.

## Deceleration Paddle Selector

When you release the accelerator pedal, you can control the rate of deceleration without removing your hands from the steering wheel. Using the deceleration paddle selector situated on the steering wheel, you can sequentially shift through four stages of deceleration.

When descending a hill, you can use the deceleration paddle selector to help maintain the rate of deceleration, thereby allowing you to keep a safe distance between your vehicle and the vehicle ahead.

### ⌘ Deceleration Paddle Selector

#### CAUTION

Rapidly increasing the deceleration rate by quickly shifting the deceleration paddle selector can cause the tyres to skid, resulting in a crash that could injure or kill someone.

Always maintain a reasonable rate of deceleration.

## ■ Deceleration Paddle Selector Operation

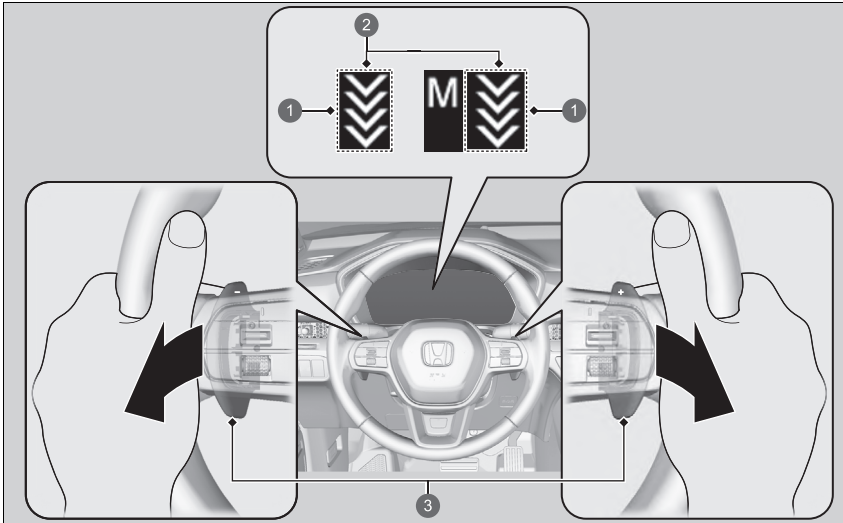

- ❶ Deceleration Paddle Selector Indicator
- ❷ Deceleration Stage
- ❸ Paddle Selector

### ▣ Deceleration Paddle Selector

In the following situations, the stage may not change and the stage icon will blink even if you pull back the selector. The deceleration stage may decrease or cancel automatically when:

- The High Voltage battery is fully charged or its temperature is too cold or too hot.
- The speed of the vehicle is beyond the deceleration range with **SPORT** mode off.
- Hybrid system protection is needed.

You cannot use the deceleration paddle selector when ACC with Low Speed Follow is in operation. If either paddle selector is operated while driving, ACC with Low Speed Follow will cancel automatically.

If you pull back the right and left paddle selector at the same time, the deceleration stage may not change.

■ **When the shift position is in D**

If you pull back the paddle selector, the rate of deceleration will increase temporarily, and the stage will appear on the gauge.

The deceleration paddle selector will cancel automatically and the deceleration paddle selector indicator on the gauge will disappear when you drive at a constant speed or slow to a near stop.

■ **When the shift position is in D and drive mode is **SPORT****

If you choose **SPORT** mode, the rate of deceleration will increase and the stage along with **M** will appear.

When you want to cancel the deceleration paddle selector, change out of **SPORT** mode. When cancelled, the deceleration paddle selector indicator on the gauge disappears.



■ **When the shift position is in B**

If you change the shift position to B, the rate of deceleration will increase and the stage along with **M** will appear.

When you want to cancel the deceleration paddle selector, change the shift position to D and change out of **SPORT** mode. When cancelled, the deceleration paddle selector indicator on the gauge disappears.

## ■ Common operations

To select the different stages of deceleration:

- Pull back the  selector (right side) to decrease the deceleration stage.
- Pull back the  selector (left side) to increase the deceleration stage.

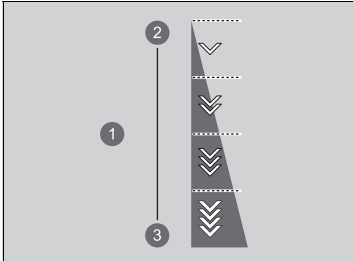

Each paddle selector operation makes a single stage deceleration change.

- ▶ The deceleration stage may not change if you keep the paddle selector pulled back.

- 1 Deceleration Stage
- 2 Decrease
- 3 Increase

## Acoustic Vehicle Alerting System

---

Alerts pedestrians when a vehicle is propelled solely by electricity, approaching at speeds around 25 km/h (16 mph) or less.

## Drive Mode Switch

You can choose between five modes, **SPORT** mode, **NORMAL** mode, **ECON** mode, **SNOW** mode and **TOW** mode by using the **DRIVE MODE** switch.

The current mode is displayed on the driver information interface, and each mode will appear differently.

### Drive Mode Switch

The mode may not be able to be changed under some driving conditions.

If there is a vehicle system failure, the following message will also appear on the driver information interface, and you cannot select any other mode.

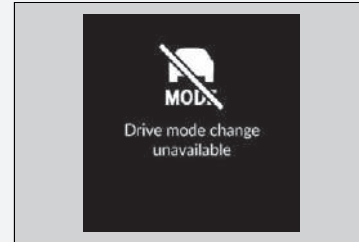

## ■ Selecting the Drive Mode

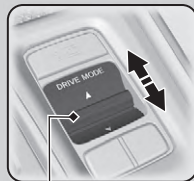
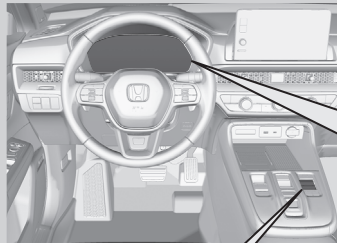

6

1

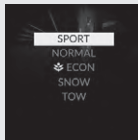

2

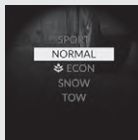

3

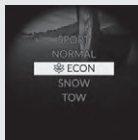

4

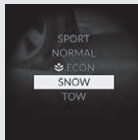

5

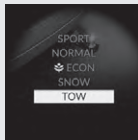

- ① **SPORT** Mode
- ② **NORMAL** Mode
- ③ **ECON** Mode
- ④ **SNOW** mode
- ⑤ **TOW** mode
- ⑥ **DRIVE MODE** Switch

## ■ SPORT Mode

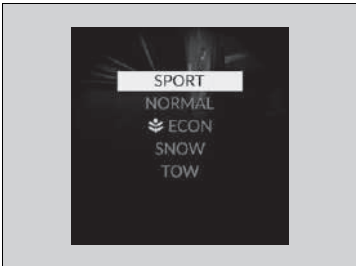

Enhances responsiveness to the driver's input.

## ■ NORMAL Mode

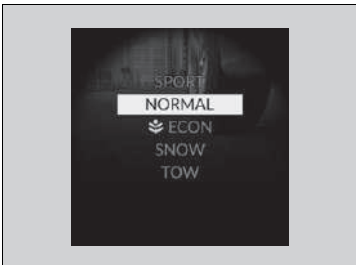

Optimises the balance between operability and comfort.

## ECON Mode

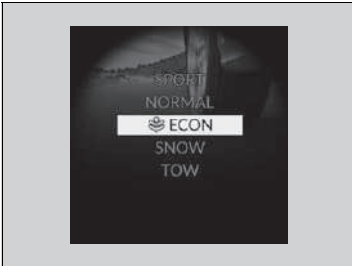

Facilitates fuel-efficient driving.

## SNOW Mode

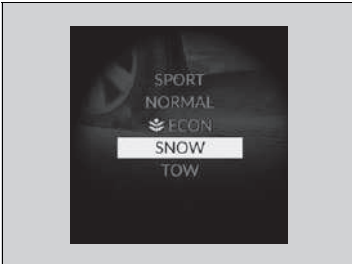

Maximises controllability on snowy road through powertrain settings.

### ⌘ ECON Mode

While in **ECON** mode, the climate control system will be less effective and the vehicle slower to accelerate.

### ⌘ SNOW Mode

#### NOTICE

**SNOW** mode does not allow you to drive on snowy or frozen roads in all situations. There are limits to **SNOW** mode.

When driving on snowy or frozen roads; mount winter tyres or tyre chains, reduce speed, and maintain sufficient distance between vehicles.

➤ **Snow Traction Devices** P. 714

## ■ TOW Mode

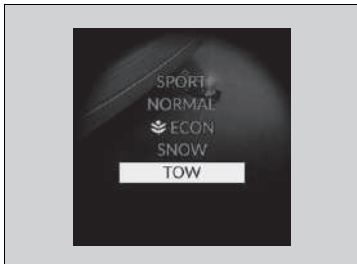

Optimises balance between driving performance and comfort when towing a trailer.

## ■ Next Start-up Mode

The mode for the next start-up is saved according to the following chart.

Each keyless remote has its own mode saved.

Last Mode	Next Mode
SPORT, NORMAL, SNOW or TOW	NORMAL
ECON	ECON

## ▶▶ TOW Mode

While in **TOW** Mode, some features of Honda SENSING 360 are turned off.

▶ **Honda SENSING 360** P. 479

When the Drive Mode is in **TOW** mode, Low Speed Braking Control and the rear parking sensor system do not operate when reversing.

▶ **Low Speed Braking Control** P. 498

▶ **Parking Sensor System** P. 602

For more details on towing, refer to the following.

▶ **Towing a Trailer** P. 420

## Adaptive Damper System

---

Constantly controls your vehicle's front and rear dampers according to current road conditions, vehicle speed and steering operation.

You can change handling response by turning the **SPORT** mode on.

🗲 **Drive Mode Switch** P. 445

## Hill Descent Control System

When driving down hills where engine braking is not enough to decelerate the vehicle, this system helps maintain a constant vehicle speed without needing to depress the brake pedal.

### Hill Descent Control Operating Conditions

The system operates under the following conditions.

- Driving at a speed between about 3-20 km/h (2-12 mph).
- Driving downhill.
- Accelerator pedal and brake pedal are not depressed.

### Driver information interface display

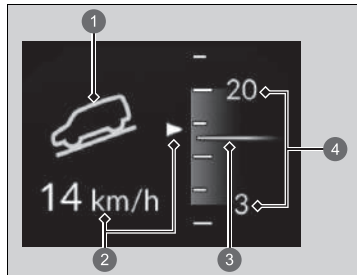

- 1 The system's operating status
  - Green: Activated
  - White: Standby
- 2 Vehicle speed display
  - White: Set speed
  - Grey: Current speed
    - ▶ Blinks when the vehicle speed is above the operating speed.
- 3 Current speed
- 4 Operating range of set speed

### Hill Descent Control System

## ⚠ WARNING

Hill descent control cannot maintain a constant vehicle speed in every situation.

When driving down a very steep hill or on slippery road surfaces, the vehicle may not be able to maintain the vehicle speed and could cause a crash, resulting in serious injury or death.

Since Hill Descent Control is not designed to increase the limits of vehicle performance, the driver must always be aware of road surface conditions and drive safely.

The brake lights automatically come on while the system is in operation.

The system may not operate when driving down a gentle slope. Check the Hill Descent Control System indicator to see if the system is in operation.

The system may activate even when not driving downhill, such as when the vehicle leans while driving over uneven surfaces.

## ■ How to Operate Hill Descent Control



- 1 Hill Descent Control System Indicator
- 2  (Hill Descent Control) Button

### ■ To turn the system on

When the vehicle speed is less than about 20 km/h (12 mph), press the  button to turn the system on.

- ▶ The system goes into standby mode, and the Hill Descent Control System indicator (white) comes on.

When all the working conditions are met, the system activates, and the vehicle begins to maintain the vehicle speed when driving downhill.

- ▶ The Hill Descent Control System indicator (green) comes on when operating.

### ■ To adjust the set speed

Depress the accelerator pedal or brake pedal to adjust the vehicle speed within the operating range. The vehicle speed at which you release the accelerator pedal or brake pedal will be the set speed.

### ■ To turn the system off

Press the  button to turn the system off.

## ☒ How to Operate Hill Descent Control

Using the system repeatedly for a long time may cause the brakes to heat up and make the system go into standby mode temporarily.

Hill Descent Control is turned off every time you turn the power system off, even if it was turned on the last time you drove the vehicle.

The pedals may vibrate or you may hear the system working when in operation.

## ☒ To turn the system off



When the vehicle speed is about 60 km/h (37 mph) or more, the system turns off automatically.

## Adjustable Speed Limiter

This system enables you to set a maximum speed that cannot be exceeded even if you are depressing the accelerator pedal.

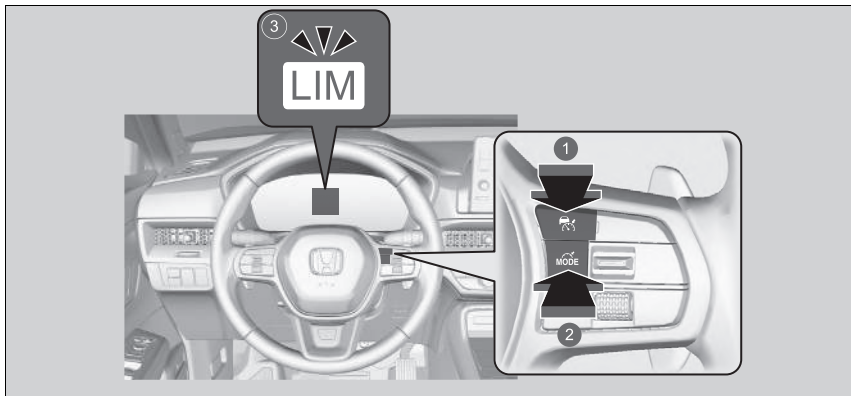
The vehicle speed limit can be set from about 30 km/h (18 mph) to about 250 km/h (156 mph).



- 1 Press the  button on the steering wheel.
- 2 If a different indicator comes on, press the  button to switch to the adjustable speed limiter.
- 3 **The Adjustable Speed Limiter Indicator (White) is on in the gauge.**  
Adjustable speed limiter is ready to use.

### Adjustable Speed Limiter

#### **WARNING**

Adjustable Speed Limiter has limitations. It is always your responsibility to adjust the vehicle speed to obey the actual speed limit, and safely operate the vehicle.

#### **WARNING**

Do not depress the accelerator pedal more than necessary. Maintain an appropriate accelerator pedal position depending on the vehicle speed.

The adjustable speed limiter may not hold the set speed limit when driving downhill, especially if you are carrying a heavy luggage or towing a trailer. If this occurs, slow down by depressing the brake pedal.

When not using the adjustable speed limiter:  
Turn off the adjustable speed limiter by pressing the  button.

You cannot use the Adjustable Speed Limiter and below systems at the same time.  
-Adaptive cruise control (ACC) with low speed follow  
-Intelligent speed limiter

## ■ To Set the Speed Limit

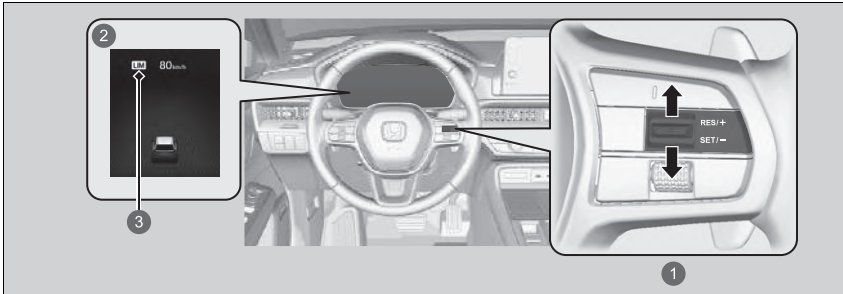

① **RES/+ / SET/-** Switch  
Up or down

② On when the adjustable speed limiter is set.

③ Adjustable Speed Limiter Indicator (Green)

- Press the **RES/+ / SET/-** switch up or down when you reach the desired speed. The moment you release the switch, the speed limit is fixed, and the adjustable speed limiter is set. The speed limit is displayed.
- You can set the previously set speed limit by pressing the **RES/+ / SET/-** switch up.

## ☒ To Set the Speed Limit

If you set the speed limit while travelling at less than 30 km/h (18 mph), the speed limit is set to 30 km/h (18 mph).

The adjustable speed limiter is set to the current speed if it is higher than the previously set speed limit when you press the **RES/+ / SET/-** switch up.

You can switch the displayed set speed measurements between km/h and mph on the driver information interface or audio/information screen.

☒ **Speed/Distance Units** P. 175

☒ **How to Customize the Vehicle Settings**  
P. 368

## ■ To Adjust the Speed Limit

Increase or decrease the speed limit by using the **RES/+**/**SET/-** switch on the steering wheel.

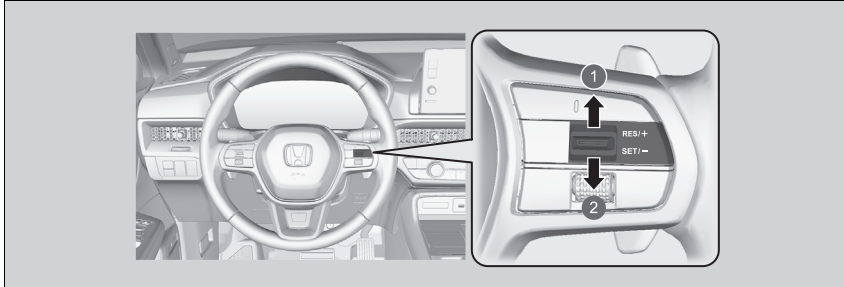

- ① To increase speed
- ② To decrease speed

- Each time you press the **RES/+**/**SET/-** switch up or down, the speed limit increases or decreases by 1 km/h or 1 mph accordingly.
- If you keep the **RES/+**/**SET/-** switch pressed, the speed limit increases or decreases in increments of 10 km/h or 10 mph every 0.5 second until system limit is reached.
- The vehicle may accelerate or decelerate until the set speed is reached.

## ■ Exceeding the Speed Limit Temporarily

The speed limit can be exceeded by depressing the accelerator pedal completely.

- ▶ The displayed limit speed blinks.
- ▶ The beeper sounds once the speed limit has been exceeded.

## ⊠ Exceeding the Speed Limit Temporarily

The beeper sounds when the vehicle speed goes higher than the set speed limit with the accelerator pedal depressed completely.

The adjustable speed limiter resumes working once the vehicle speed goes lower than the set speed limit.

*Continued*

## ■ To Cancel

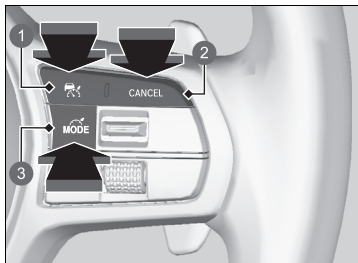

- ① Button
- ② **CANCEL** Button
- ③ Button

To cancel the adjustable speed limiter, do any of the following:

- Press the **CANCEL** button.
- Press the button.
- Press the button.

## ▶▶ To Cancel

The adjustable speed limiter changes into adaptive cruise control (ACC) with Low Speed Follow or intelligent speed limiter if the button is pressed.

Resuming the prior set speed:  
Press the **CANCEL** button to display the prior set speed (grey) and press the **RES/+ / SET/-** switch up to resume the prior set speed.  
If you are driving at a speed faster than the prior set speed (grey), the adjustable speed limiter is set to the current speed by pressing the **RES/+ / SET/-** switch up.  
If you press the **RES/+ / SET/-** switch up when no prior set speed (in grey) is displayed, the speed will be set to your vehicle's current speed.

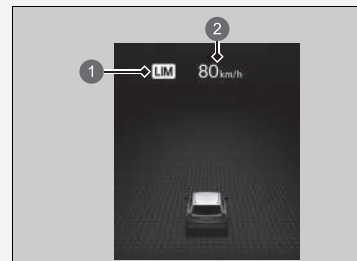

- ① Adjustable Speed Limiter Indicator (White)
- ② Prior Set Speed (Grey)

## ▶▶ To Cancel

If there is a problem with the system when you are using the adjustable speed limiter, the beeper sounds and **OFF** comes on. The adjustable speed limiter will be turned off.

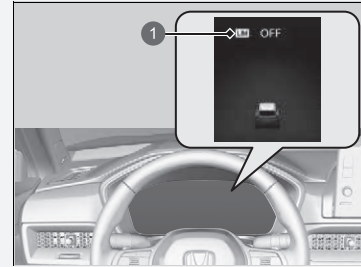

- 1 Adjustable Speed Limiter Indicator (White)

## Intelligent Speed Limiter

Automatically sets the speed limit that the traffic sign recognition system detects. And the speed limit cannot be exceeded even if you are depressing the accelerator pedal. If you fully depress the accelerator the speed limit can be exceeded.

➤ **Traffic Sign Recognition System** P. 576



### Intelligent Speed Limiter

#### **WARNING**

Intelligent Speed Limiter has limitations. The Intelligent Speed Limiter may set itself to a speed above or below the actual speed limit, or may not work, particularly where the traffic sign recognition system does not operate correctly or where a road has no speed limit signs. It is always your responsibility to adjust the speed to obey the actual speed limit and to safely operate the vehicle.

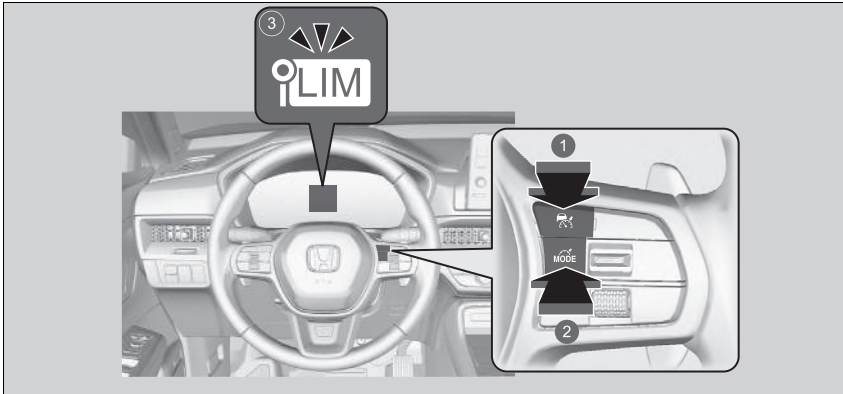
Depending on the amount of depression of the accelerator pedal, the vehicle will accelerate until it reaches the speed identified by the traffic sign recognition system.



- 1 Press the  button on the steering wheel.
- 2 If a different indicator comes on, press the  button to change it to the intelligent speed limiter.
- 3 **The Intelligent Speed Limiter Indicator (White) is on in the gauge.**  
Intelligent speed limiter is ready to use.



### Intelligent Speed Limiter

The system is designed to detect signs that follow the Vienna Convention standards. Not all signs may be detected, but any signs posted on roadsides should not be ignored. The system does not work on the designated traffic signs of all the countries you travel, nor in all situations.

#### Traffic Sign Recognition System P. 576

If the intelligent speed limiter is set to the wrong speed limit, try one of the following:

To cancel

- Press the **CANCEL** button.
- Press the  button.
- Press the  button.

To exceed the speed limit temporarily

- Depressing the accelerator pedal fully.

The intelligent speed limiter may not hold the set speed limit when driving downhill, especially if you are carrying a heavy luggage or towing a trailer. If this occurs, slow down by depressing the brake pedal.

When not using the intelligent speed limiter, turn off the intelligent speed limiter by pressing the  button.

You cannot use the intelligent speed limiter and adaptive cruise control (ACC) with Low Speed Follow or adjustable speed limiter at the same time.

## ■ To Set the Speed Limit

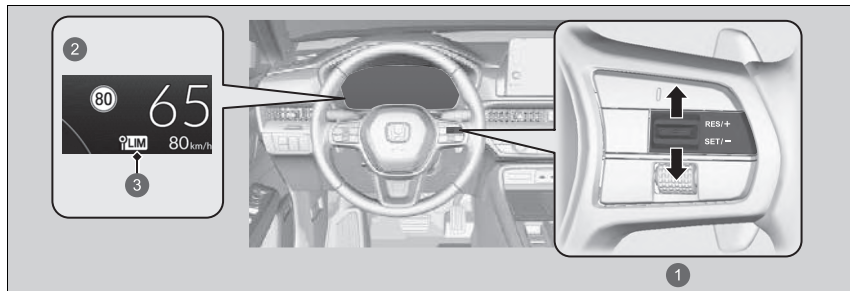

① **RES/+ / SET/-** Switch

Up or down

② On when the intelligent speed limiter is set to the speed limit that the traffic sign recognition system detects.

③ Intelligent Speed Limiter Indicator (Green)

- The moment you release the **RES/+ / SET/-** switch, the intelligent speed limiter is set to the speed limit that the traffic sign recognition system detects. The speed limit is displayed.

## ▶▶ Intelligent Speed Limiter

Do not use the intelligent speed limiter in areas of different units from the display unit of the intelligent speed limiter.

Change the displayed measurement of the set vehicle speed to the same units as the driving areas.

▶ **Speed/Distance Units** P. 175

▶ **How to Customize the Vehicle Settings**  
P. 368

## ▶▶ To Set the Speed Limit

If you set the intelligent speed limiter when the speed limit that the traffic sign recognition system detects is less than 30 km/h (18 mph), the speed limitation function may switch to pause.

If your vehicle speed is higher than the speed limit that the traffic sign recognition system detects, your vehicle decelerates slowly to the speed limit or less. If necessary, slow down by depressing the brake pedal.

■ **When the traffic sign recognition system detects the new speed limit sign**

The intelligent speed limiter is set to the new speed limit that the traffic sign recognition system detects.

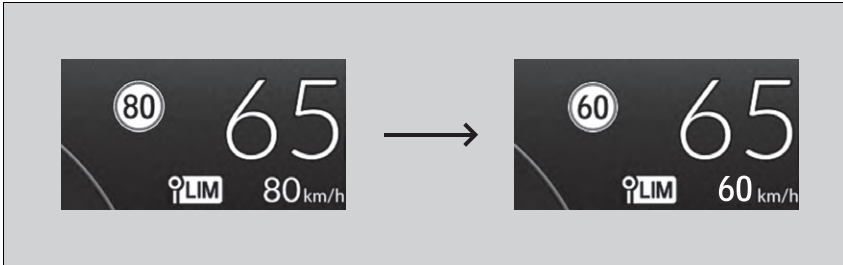

■ **The speed limitation function may switch to pause if there is no speed limit sign in the screen of the traffic sign recognition system when:**

- The end of speed limit or other designated limit is detected.
- Your vehicle enters/exits motorway or highway.
- You make a turn with a turn signal to change direction at an intersection.

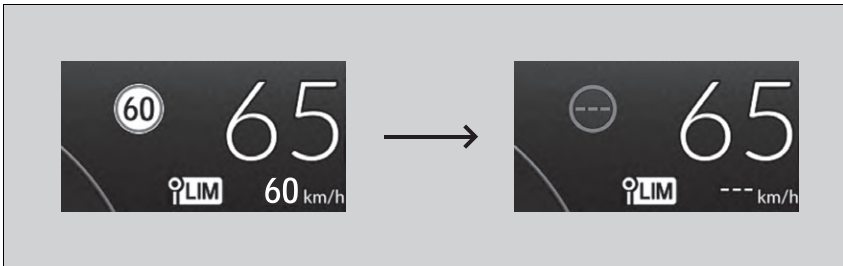

▶▶ To Set the Speed Limit

The intelligent speed limiter may also switch to pause when the traffic sign recognition system detects only additional speed limit signs.

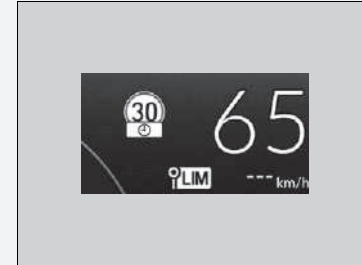

■ **When the traffic sign recognition system detects the speed limit sign while the intelligent speed limiter is paused**

The speed limitation function will be resumed automatically.



■ **Exceeding the Speed Limit Temporarily**

The speed limit can be exceeded by depressing the accelerator pedal fully.

- ▶ The displayed speed limit blinks.  
The beeper sounds once the speed limit has been exceeded.

▶ **Exceeding the Speed Limit Temporarily**

The beeper sounds when the vehicle speed goes higher than the set speed limit with the acceleration pedal depressed completely.

The intelligent speed limiter resumes working once the vehicle speed goes lower than the set speed limit.

## ■ To Cancel

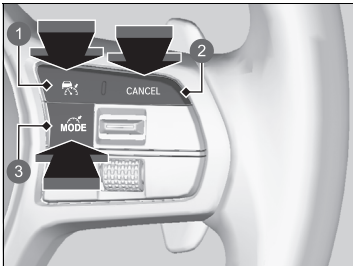

- ① Button
- ② **CANCEL** Button
- ③ Button

To cancel the intelligent speed limiter, do any of the following:

- Press the **CANCEL** button.
- Press the button.
- Press the button.

## ☒ To Cancel

The intelligent speed limiter changes into adaptive cruise control (ACC) with Low Speed Follow or adjustable speed limiter if the button is pressed.

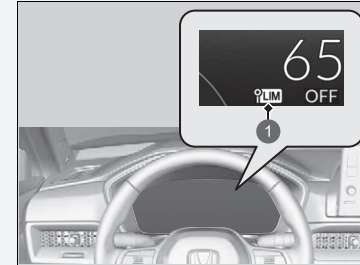

- ① Intelligent Speed Limiter Indicator (White)

If there is a problem with the system or traffic sign recognition system when you are using the intelligent speed limiter, the beeper sounds and **OFF** comes on. The intelligent speed limiter will be turned off.

☒ **Traffic Sign Recognition System** P. 576

## Vehicle Stability Assist (VSA) System

VSA helps to stabilise the vehicle during cornering if the vehicle turns more or less than what was intended. It also assists in maintaining traction on slippery surfaces. It does so by regulating engine and motor output and selectively applying the brakes.

### ▣ Vehicle Stability Assist (VSA) System

The VSA may not function properly if tyre type and size are mixed. Make sure to use the same size and type of tyre, and the air pressures as specified.

When the VSA system indicator comes on and stays on while driving, there may be a problem with the system. While this may not interfere with normal driving, have your vehicle checked by a dealer immediately.

VSA cannot enhance stability in all driving situations and does not control the entire braking system. You still need to drive and corner at speeds appropriate for the conditions and always leave a sufficient margin of safety.

The main function of the VSA system is generally known as Electronic Stability Control (ESC). The system also includes a traction control function.

The Vehicle Stability Assist (VSA) system, brake system (Amber), Adaptive Cruise Control (ACC) with Low Speed Follow, low tyre pressure/deflation warning system, Collision Mitigation Braking System (CMBS), Road Departure Mitigation and safety support indicators may come on in amber along with a message in the gauge when you set the power mode to ON after reconnecting the 12-volt battery. Drive a short distance at more than 20 km/h (12 mph).

Each indicator should go off. If any do not, have your vehicle checked by a dealer.

### ■ VSA Operation

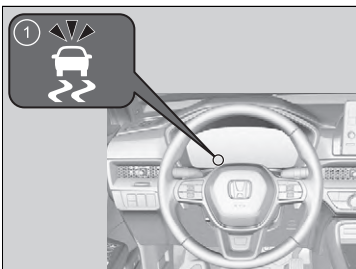

When VSA activates, you may notice that the engine and motor do not respond to the accelerator. You may also notice some noise from the hydraulic brake system. You will also see the indicator blink.

1 VSA System Indicator

## ■ VSA On and Off

You can partially disable VSA features using the driver information interface.

➤ **Switching the Display** P. 164

➤ **Vehicle Stability Assist Mode** P. 176

Your vehicle will have normal braking and cornering ability, but traction control function will be less effective.

VSA is turned on every time you turn the power system on, even if you turned it off the last time you drove the vehicle.

### ⊠ Vehicle Stability Assist (VSA) System

In certain unusual conditions when your vehicle gets stuck in shallow mud or fresh snow, it may be easier to free it with the VSA temporarily switched off.

When the VSA is set to OFF (unchecked), the traction control function becomes less effective. This allows for the wheels to spin more freely at low speed. You should only attempt to free your vehicle with the VSA off if you are not able to free it when the VSA is on.

Immediately after freeing your vehicle, be sure to switch VSA on again. We do not recommend driving your vehicle with the VSA system switched off.

When the VSA system is off, trailer stability assist is also off.

➤ **Trailer Stability Assist** P. 423

You may hear a motor sound coming from the engine compartment while system checks are being performed immediately after turning the power system on or while driving. This is normal.

## Agile Handling Assist

Lightly brakes each of the front and rear wheels, as needed, when you turn the steering wheel, and helps to support the vehicle's stability and performance during cornering.

### ⚡ Agile Handling Assist

The agile handling assist cannot enhance stability in all driving situations. You still need to drive and corner at speeds appropriate for the conditions and always leave a sufficient margin of safety.

When the VSA system indicator comes on and stays on while driving, the agile handling assist does not activate.

You may hear a sound coming from the engine compartment while the agile handling assist is activated. This is normal.

## Deflation Warning System

Instead of directly measuring the pressure in each tyre, the deflation warning system on this vehicle monitors and compares the rolling radius and rotational characteristics of each wheel and tyre while you are driving to determine if one or more tyres are significantly under-inflated.

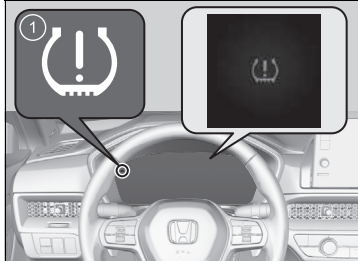

1 Low Tyre Pressure/Deflation Warning System Indicator

This will cause the low tyre pressure/deflation warning system indicator to come on and a message to appear on the gauge.

### Deflation Warning System Calibration

You must start deflation warning system calibration every time you:

- Adjust the pressure in one or more tyres.
- Rotate the tyres.
- Replace one or more tyres.

Before calibrating the deflation warning system:

- Set the cold tyre pressure in all four tyres.

➤ **Checking Tyres** P. 710

Make sure:

- The vehicle is at a complete stop.
- The transmission is in **P**.
- The power mode is in ON.

#### Deflation Warning System

The system does not monitor the tyres when driving at low speed.

Conditions such as low ambient temperature and altitude change directly affect tyre pressure and can trigger the low tyre pressure/deflation warning system indicator to come on.

Tyre pressure checked and inflated in:

- Warm weather can become under-inflated in colder weather.
- Cold weather can become overinflated in warmer weather.

The low tyre pressure/deflation warning system indicator will not come on as a result of overinflation.

The deflation warning system may not function properly if tyre type and size are mixed.

Make sure to use the same size and type of tyre.

➤ **Checking and Maintaining Tyres** P. 710

The Vehicle Stability Assist (VSA) system, brake system (Amber), Adaptive Cruise Control (ACC) with Low Speed Follow, low tyre pressure/deflation warning system, Collision Mitigation Braking System (CMBS), Road Departure Mitigation and safety support indicators may come on in amber along with a message in the gauge when you set the power mode to ON after reconnecting the 12-volt battery. Drive a short distance at more than 20 km/h (12 mph). Each indicator should go off. If any do not, have your vehicle checked by a dealer.

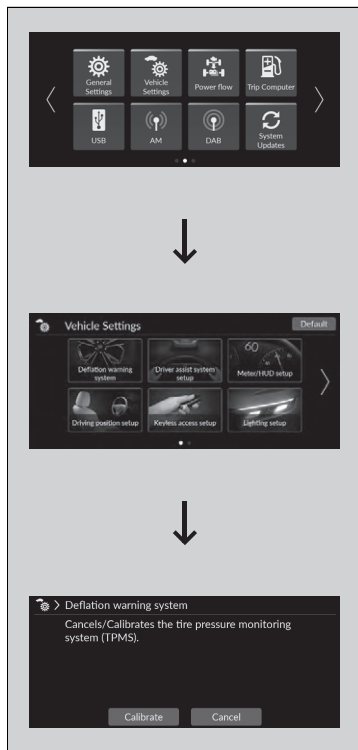

When you calibrate the deflation warning system, do the following.

▶ **Basic Operation P. 293**

1. Set the power mode to ON.
  2. Press the  button.
  3. Select **Vehicle Settings**.
  4. Select **Deflation warning system**.
  5. Select **Calibrate** or **Cancel**.
- If the **Calibration Failed to Start** message appears, repeat step 5.
  - The calibration process finishes automatically.

▶▶ Deflation Warning System

The low tyre pressure/deflation warning system indicator may come on with a delay or may not come on at all when:

- You rapidly accelerate, decelerate, or turn the steering wheel.
- You drive on snowy or slippery roads.
- Tyre chains are used.
- The tyre loses air pressure rapidly.

The low tyre pressure/deflation warning system indicator may come on under the following conditions:

- There is a heavier and uneven load on the tyres, such as when towing a trailer, than the condition at calibration.
- Tyre chains are used.

▶▶ Deflation Warning System Calibration

The calibration process requires approximately 30 minutes of cumulative driving at speeds between 40-100 km/h (25-62 mph).

During this period, if the power mode is set to ON and the vehicle is not moved within 45 seconds, you may notice the low tyre pressure/deflation warning system indicator comes on briefly. This is normal and indicates that the calibration process is not yet complete.

If the tyre chains are installed, remove them before calibrating the deflation warning system.

If the low tyre pressure/deflation warning system indicator comes on even when the properly inflated specified regular tyres are installed, have your vehicle checked by a dealer.

We recommend that the tyres be replaced with the same brand, model, and size as the originals. Ask a dealer for details.

## Blind Spot Information System

When the system detects vehicles approaching from behind in adjacent lanes, the appropriate indicator comes on, providing assistance when you change lanes.

### How the System Works

The system activates when your vehicle is moving forward at about 20 km/h (12 mph) or above.

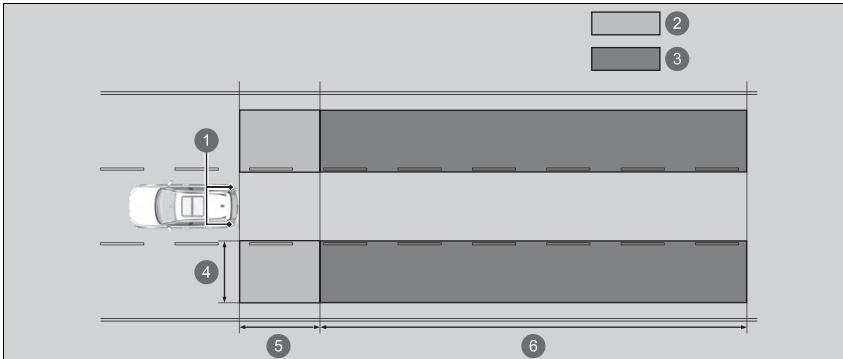

- ❶ Radar Sensors: underneath the rear bumper corners
  - ❷ Alert Zone 1
  - ❸ Alert Zone 2
- Alert zone range
- ❹ Approx. 0.5 ~ 3 m (1.6 ~ 10 ft.) from vehicle side.
  - ❺ Approx. 3 m (10 ft.) from rear bumper.
  - ❻ Approx. 3 ~ 50 m (10 ~ 164 ft.) behind from rear bumper. (The faster the approaching vehicle, the further away it will be detected.)

### Blind Spot Information System

#### Important Safety Reminder

Like all assistance systems, the blind spot information system has limitations. Always look in your mirrors, to either side of your vehicle, and behind you for other vehicles before changing lanes. Overreliance on the blind spot information system may result in a collision.

Have your vehicle checked by a dealer in the following situations:

- The rear bumper or area around the radar sensors is strongly impacted.
- The indicator does not come on even if a vehicle in the alert zone should have been detected.
- The rear bumper or any system components need to be repaired.

For proper blind spot information system operation:

- Always keep the rear bumper and area around the radar sensors clean.
- Do not cover the rear bumper corner area with labels or stickers of any kind.

### ■ When the system detects a vehicle

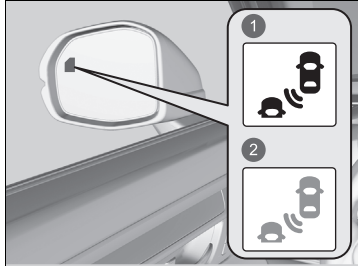

- ① Comes On
- ② Blinks

Lane Change Collision Mitigation indicator:  
Located on the outside rearview mirror on  
both sides.

#### Comes on when:

- A vehicle approaches you from behind to overtake you at a speed difference of no more than about 50 km/h (31 mph).
- You pass a vehicle at a speed difference of no more than about 14 km/h (9 mph).

#### Blinks and a beeper sounds when:

You use the turn signal lever to signal a turn in the direction of the detected vehicle while the Lane Change Collision Mitigation indicator is on.

- ▶ The beeper sounds three times.

### ▣ Blind Spot Information System

The Vehicle Stability Assist (VSA) system, brake system (Amber), Adaptive Cruise Control (ACC) with Low Speed Follow, low tyre pressure/deflation warning system, Collision Mitigation Braking System (CMBS), Road Departure Mitigation and safety support indicators may come on in amber along with a message in the gauge when you set the power mode to ON after reconnecting the 12-volt battery. Drive a short distance at more than 20 km/h (12 mph). Each indicator should go off. If any do not, have your vehicle checked by a dealer.

Turn the system off when towing a trailer.

The system may not work properly for the following reasons:

- The added mass tilts the vehicle and changes the radar coverage.
- The trailer itself can be detected by the radar sensors, causing the blind spot information system alert indicators to come on.

For directions on the proper handling of the Lane Change Collision Mitigation system, refer to the following page.

▶ **Lane Change Collision Mitigation** P. 518

## Blind Spot Information System On and Off

You can turn the system on and off using the driver information interface.

➤ **Switching the Display** P. 164

➤ **Safety Support** P. 173

The blind spot information system operates when the Lane Change Collision Mitigation System is set to ON.

➤ **Lane Change Collision Mitigation On and Off** P. 520

The blind spot information system will stay on the previously selected on or off setting each time you turn the power system on.

## Blind Spot Information System

You can change the settings for the blind spot information system.

➤ **How to Customize the Vehicle Settings**

P. 368

## ■ Blind Spot Information System Conditions and Limitations

Lane Change Collision Mitigation indicator may not come on under the following conditions:

- There is a large speed difference between your vehicle and the vehicle in the adjacent lane.
- A vehicle is parked in a side lane.
- An object not detected by the radar sensors approaches or passes your vehicle.
- The vehicle driving in the adjacent lane is a motorcycle or other small vehicle.

The blind spot information system may not operate correctly under the following conditions:

- Making a turn at an intersection.
- Objects (guard rails, poles, trees, etc.) are detected.
- An object that does not reflect radio waves well or a motorcycle, is in the alert zone.
- Driving on a curved road.
- A vehicle is moving from a far lane to the adjacent lane.
- The system picks up signal interference such as other radar sensors from another vehicle or strong radio wave transmitted from a facility nearby.
- The rear bumper or the area around the radar sensors is covered by dirt, mud, snow, ice, etc.
- The rear bumper or the area around the radar sensors has been damaged or deformed.
- In bad weather (heavy rain, snow, and fog).
- Making a short turn or driving on a bumpy road that slightly tilts the vehicle.
- The vehicle is tilted due to heavy luggage in the luggage area or rear seats.
- An object such as a bicycle rack is attached to the rear of the vehicle.
- When nearby radio wave emitting devices such as other automotive radar sensors.
- When driving for long distances on a road in a trafficless area such as a desert.
- Driving on snowy or slippery roads.

## LaneWatch

LaneWatch is an assistance system that allows you to check the passenger side rear areas displayed on the audio/information screen when the turn signal is activated to the passenger's side.

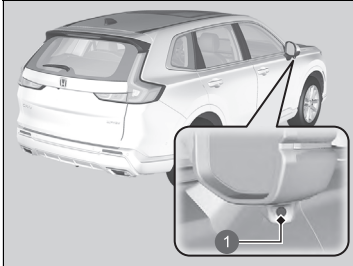

1 Camera

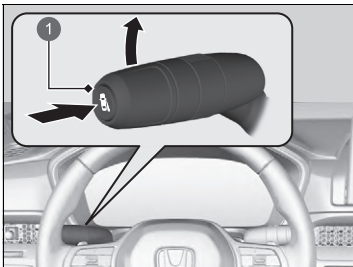

1 LaneWatch Button

A camera in the passenger side door mirror monitors these areas and allows you to check for vehicles, in addition to your visual check and use of the passenger door mirror. You can also keep the system on for your convenience while driving.

The system activates when you do either of the following operations:

- Press the LaneWatch button.
- Move the turn signal lever to the passenger side.

The system deactivates when you press the LaneWatch button again.

### ⓘ LaneWatch

## ⚠ WARNING

Failure to visually confirm that it is safe to change lanes before doing so may result in a crash and serious injury or death.

Do not rely only on LaneWatch while driving.

Always look in your mirrors, to either side of your vehicle, and behind you for other vehicles before changing lanes.

### Important Safety Reminder

Like all assistance systems, LaneWatch has limitations. Overreliance on LaneWatch may result in a collision.

The LaneWatch function can be affected by weather, lighting (including headlights and low sun angle), ambient darkness, camera condition, and loading.

The LaneWatch may not provide the intended display of traffic to the side and rear under the following conditions:

- Your vehicle's suspension has been altered, changing the height of the vehicle.
- Your tyres are over or under inflated.
- Your tyres or wheels are of varied size or construction.

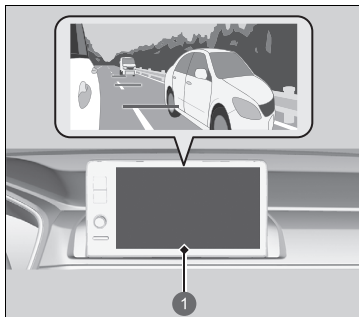

1 Audio/Information Screen

The passenger side view display appears on the audio/information screen.

### ■ Customizing the LaneWatch settings

You can customize the following items using the audio/information screen.

- **Show with indicator:** Selects whether LaneWatch monitor comes on when you operate the turn signal lever.
- **Display Time after Indicator Off:** Changes the remaining LaneWatch display time after you pull the turn signal lever back.
- **Show Reference Line:** Selects whether the reference lines appear on the LaneWatch monitor.
- **Display:** Adjusts display settings.
  - ▶ **Customized Features** P. 360

### ▶ LaneWatch

The LaneWatch camera view is restricted. Its unique lens makes objects on the screen look slightly different from what they are.

LaneWatch display does not come on when the transmission is in **[R]**.

For proper LaneWatch operation:

- The camera is located in the passenger side door mirror. Always keep this area clean. If the camera lens is covered with dirt or moisture, use a soft, moist cloth to keep the lens clean and free of debris.
- Do not cover the camera lens with labels or stickers of any kind.
- Do not touch the camera lens.

## ■ Reference Lines

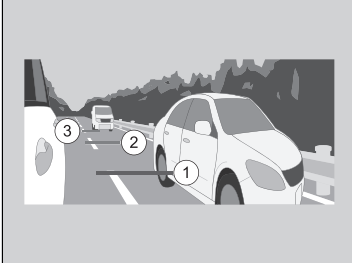

Three lines that appear on the screen can give an idea of how far the vehicles or objects on the screen are from your vehicle, respectively. If an object is near line ① (in red), it indicates that it is close to your vehicle whereas an object near line ③ is farther away.

### ☒ Reference Lines

The area around the reference line ① (red) is very close to your vehicle. As always, make sure to visually confirm the safety of a lane change before changing lanes.

The distance between your vehicle and lines ①, ② and ③ on the screen vary depending on road conditions and vehicle loading. For example, the reference lines on the screen may seem to appear closer than the actual distances when the rear of your vehicle is more heavily loaded.

Consult a dealer if:

- The passenger side door mirror, or area around it is severely impacted, resulting in changing the camera angle.
- The LaneWatch display does not come on at all.

## Adjusting Headlight Distribution

Driving the right-hand type vehicle in right-hand traffic, or the left-hand type vehicle in left-hand traffic causes headlight glare to oncoming vehicles. You need to alter the headlight beam distribution using masking tape.

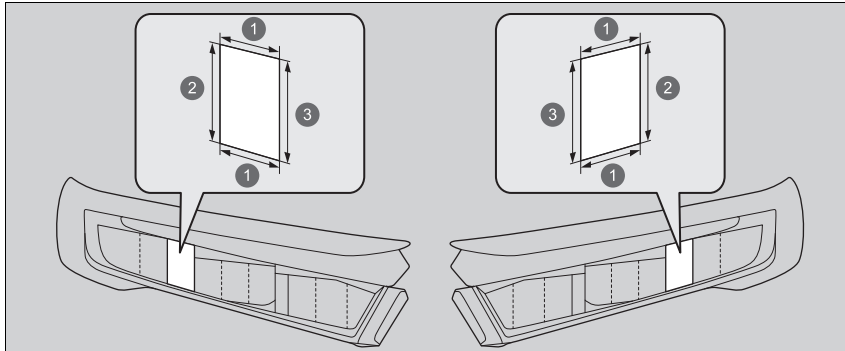

- ① 45 mm
- ② 49 mm
- ③ 48 mm

1. Prepare for two pieces of masking tape as shown.
  - ▶ Use masking tape that can shut out light, such as seal type waterproof vinyl.
2. Affix the tape to the lens as shown.

### ▶▶ Adjusting Headlight Distribution

Be careful not to adhere the tape to an incorrect location. If the headlight beam is distributed incorrectly, it may not comply with your country's legal requirements. Ask your dealer for details.

Assists with functions such as acceleration, braking, and steering in order to reduce the burden on the driver, as well as help to avoid or reduce the severity of collisions.

Honda SENSING 360 has the following functions:

## ■ The functions that do not require switch operations to activate

- Collision Mitigation Braking System (CMBS) 📖 P. 484
- Low Speed Braking Control 📖 P. 498
- Front Cross Traffic Warning 📖 P. 504
- Road Departure Mitigation System 📖 P. 510
- Lane Change Collision Mitigation 📖 P. 518
- Traffic Sign Recognition System 📖 P. 576
- Adaptive Driving Beam\* 📖 P. 238
- Blind Spot Information System 📖 P. 471
- Parking Sensor System 📖 P. 602
- Cross Traffic Monitor 📖 P. 607
- Driver Attention Monitor 📖 P. 525

## ■ The functions that require switch operations to activate

- Adaptive Cruise Control (ACC) with Low Speed Follow 📖 P. 526
- Intelligent Speed Limiter 📖 P. 460
- Lane Keeping Assist System (LKAS) 📖 P. 550
- Traffic Jam Assist 📖 P. 561
- Active Lane Change Assist 📖 P. 570
- Honda Parking Pilot 📖 P. 626

\* Not available on all models

## 📖 Honda SENSING 360

Make sure the car is at a complete stop before you turn the power system on. If the power system is turned on in a situation where the vehicle is moving (such as when using a car turntable), some features may not activate at all.

Make sure that all the tyres are of the same specified size, type and brand, and that they are evenly worn. If you use tyres of different sizes, types, brands, or degree of wear, the system may not work properly.

Do not modify the suspension. Altering the height of the vehicle may prevent the system from working properly.

## ■ Operation Switches for the Adaptive Cruise Control (ACC) with Low Speed Follow/Lane Keeping Assist System (LKAS)/Traffic Jam Assist/Active Lane Change Assist

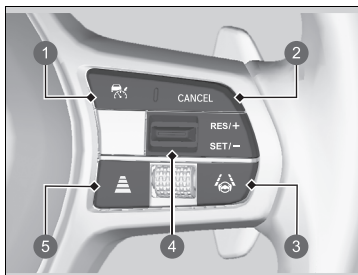

- 1**  **Button**  
Press to activate standby mode for ACC with Low Speed Follow.  
Or press to cancel the system.
- 2** **CANCEL Button**  
Press to cancel ACC with Low Speed Follow.
- 3** **LKAS Button**  
Press to activate standby mode for LKAS and Traffic Jam Assist.  
Or press to cancel these systems.
- 4** **RES/+ / SET/- Switch**  
Press the **RES/+ / SET/-** switch up to set or resume the ACC with Low Speed Follow or increase the vehicle speed.  
Press the **RES/+ / SET/-** switch down to set the ACC with Low Speed Follow or decrease the vehicle speed.
- 5** **Interval Button**  
Press to change the ACC with Low Speed Follow following-interval.

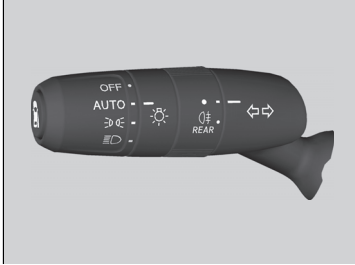

### ■ Turn Signal Lever

Operate the turn signal lever to activate Active Lane Change Assist.

## Gauge Content

You can see the current state of Adaptive Cruise Control (ACC) with Low Speed Follow, Lane Keeping Assist System (LKAS), Traffic Jam Assist and Active Lane Change Assist.

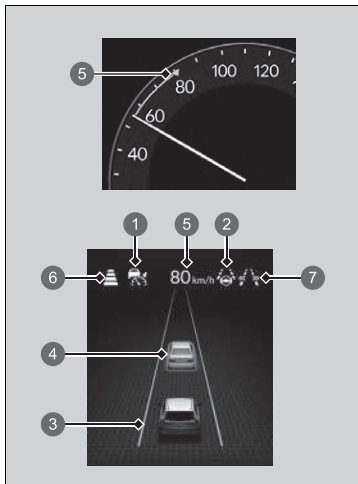

① Indicates that ACC with Low Speed Follow is ready to be activated.

- Green: The system is on.
- White: The system is standby.
- Amber: There is a problem with the system.

② Indicates that LKAS or Traffic Jam Assist is ready to be activated.

- Green: The system is operating.
- White: The system is standby.
- Amber: There is a problem with the system.

③ Indicates that LKAS or Traffic Jam Assist is activated and whether or not traffic lane lines are detected.

- Green lines: The system is operating.
- White lines: Traffic lane lines are detected.
- Amber line: Lane departure is detected.

④ Indicates whether or not a vehicle is detected ahead.

- Control target vehicle: White and outlined in green
- Outside of control target vehicle: Grey

## Gauge Content

### Models with head-up display

You can have the head-up display show you the current state of each function.

➡ **Head-Up Display**\* P. 179

- ⑤ Indicates that ACC with Low Speed Follow shows the set vehicle speed.
- ⑥ Indicates that ACC with Low Speed Follow shows the set vehicle interval.
- ⑦ Active Lane Change Assist Operating Conditions
  - Green: The system is on.
  - White: The system is standby.
  - Amber: There is a problem with the system.

## Collision Mitigation Braking System (CMBS)

The system can assist you when it determines there is a possibility of your vehicle colliding with a vehicle (including motorcycles) ahead from behind, an oncoming vehicle in front, a vehicle approaching from the side, a pedestrian, or someone riding a bicycle (moving bicycle). The CMBS is designed to alert you when the potential for a collision is determined, as well as assist in reducing speed, avoiding collisions, and reducing collision severity.

### Collision Mitigation Braking System (CMBS)

#### Important Safety Reminder

The CMBS is designed to reduce the severity of an unavoidable collision. It does not prevent collisions nor stop the vehicle automatically. It is still your responsibility to operate the brake pedal and steering wheel appropriately according to the driving conditions.

The CMBS may not activate or may not detect a vehicle in front of your vehicle under certain conditions:

➤ **CMBS Conditions and Limitations** P. 490

For directions on the proper handling of the radar sensor, refer to the following page.

➤ **Radar Sensor** P. 587

You can read about handling information for the camera equipped with this system.

➤ **Front Sensor Camera** P. 585

## ■ How the system works

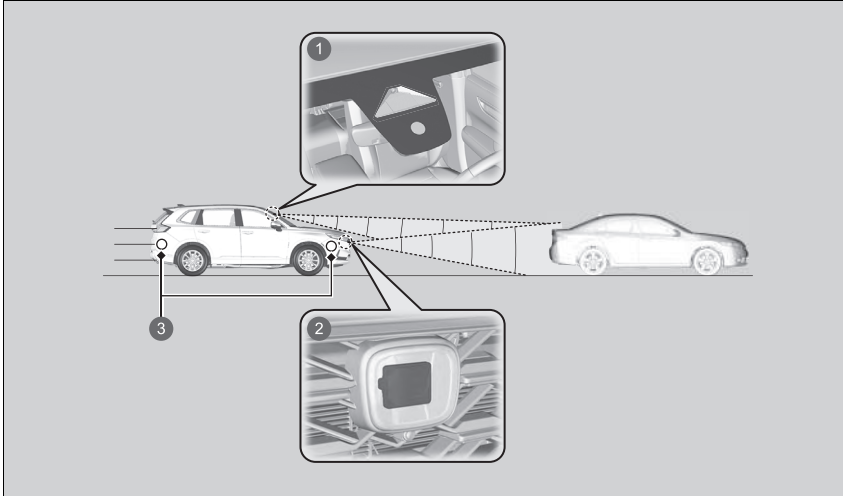

- ① A front sensor camera is located behind the rearview mirror.
- ② The radar sensor is behind the Honda emblem on the front grille.
- ③ The corner radar sensors are located in the front and rear bumpers.

The system starts monitoring the roadway ahead when your vehicle speed is about 5 km/h (3 mph) or above and will search for a vehicle (including motorcycles), pedestrian, or moving bicycle in front of you.

## ☒ How the system works

The camera in the CMBS is also designed to detect pedestrians. However, this pedestrian detection feature may not activate or may not detect a pedestrian in front of your vehicle under certain conditions. Refer to the ones indicating the pedestrian detection limitations from the list.

➤ **CMBS Conditions and Limitations** P. 490

The CMBS activates when:

- The speed difference between your vehicle and a vehicle (including motorcycles), pedestrian, or moving bicycle detected in front of you becomes about 5 km/h (3 mph) or more with a chance of a collision.
- Your vehicle drives at about 30 km/h (18 mph) or less and there is a chance of a frontal collision with a detected oncoming vehicle (including motorcycles), pedestrian, or moving bicycle when you turn left<sup>\*1</sup>/right<sup>\*2</sup> at an intersection.
- Your vehicle speed is about 100 km/h (62 mph) or less and the system determines there is a chance of a collision with:
  - ▶ An oncoming or stationary vehicle (including motorcycles) detected in front of you.
  - ▶ A pedestrian or moving bicycle detected in front of you.
  - ▶ A vehicle approaching from the side in front of you.
- The system determines there is a chance of collision with a vehicle approaching from the side while you are driving at about 85 km/h (53 mph) or less.

The CMBS will be cancelled when your vehicle stops or the system determines there no longer is the potential for a collision.

The CMBS may also be cancelled when you operate the steering wheel, brake, or accelerator pedal to avoid a collision.

\*1 : Left-hand Drive Type

\*2 : Right-hand Drive Type

### ■ When the system activates

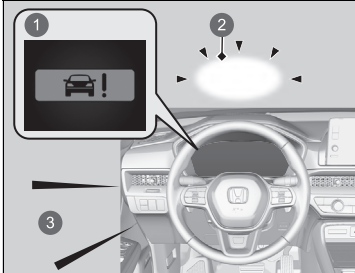

- ① Visual Alerts
- ② Head-up Warning Lights\*
- ③ Audible Alert

You can change the distance (**Far/Normal/Near**) between vehicles at which the system's earliest collision alert will come on.

📖 **How to Customize the Vehicle Settings** P. 368

When in **Far**, visual and audible alerts come on at a longer distance from a vehicle ahead than in **Normal** setting, and in **Near**, at a shorter distance than in **Normal**.

The system provides visual and audible alerts of a possible collision, and stops if the collision is avoided.

- ▶ Take appropriate action to prevent a collision (apply the brakes, change lanes, etc.)

### 📖 When the system activates

#### Models with head-up display

The head-up warning uses a lens located at the front end of the dashboard.

Do not cover the lens or spill any liquid on it.

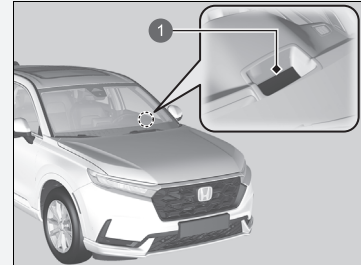

- ① Lens

\* Not available on all models

## ■ Collision Alert Stages

The system has three alert stages for a possible collision. However, depending on circumstances, the CMBS may not go through all of the stages before initiating the last stage.

Distance between vehicles		CMBS		
		The sensors detect a vehicle	Audible & Visual WARNINGS	Braking
Stage one		There is a risk of a collision with the vehicle ahead of you.	The visual alert flashes. If the distance between your vehicle and the vehicle in front of you continues to decrease, the audible alert sounds in addition to the visual alert flashing. ▶ The collision warning distance can be changed. ▶ <b>How to Customize the Vehicle Settings</b> P. 368	—
Stage two		The risk of a collision has increased, time to respond is reduced.	Visual and audible alerts.	Lightly applied
Stage three		The CMBS determines that a collision is unavoidable.		Forcefully applied

- ① Your Vehicle
- ② Vehicle Ahead
- ③ Far

- ④ Normal
- ⑤ Near

## ■ CMBS On and Off

You can turn the system on and off using the driver information interface.

📄 **Switching the Display** P. 164

📄 **Safety Support** P. 173

The CMBS is turned on every time you turn the power system on, even if you turned it off the last time you drove the vehicle.

## 📄 Collision Mitigation Braking System (CMBS)

You cannot turn the CMBS off while driving.

The CMBS may automatically shut off, and the safety support indicator (amber) and Collision Mitigation Braking System (CMBS) indicator (amber) will come and stay on under certain conditions:

📄 **CMBS Conditions and Limitations** P. 490

When the CMBS is activated, it will continue to operate even if the accelerator pedal is partially depressed. However, it will be cancelled if the accelerator pedal is fully depressed.

Have your vehicle checked by a dealer if you find any unusual behaviour of the system (e.g., the warning message appears too frequently).

The Vehicle Stability Assist (VSA) system, brake system (Amber), Adaptive Cruise Control (ACC) with Low Speed Follow, low tyre pressure/deflation warning system, Collision Mitigation Braking System (CMBS), Road Departure Mitigation and safety support indicators may come on in amber along with a message in the gauge when you set the power mode to ON after reconnecting the 12-volt battery. Drive a short distance at more than 20 km/h (12 mph). Each indicator should go off. If any do not, have your vehicle checked by a dealer.

The CMBS is not activated for about 15 seconds after the power system is turned on.

## ■ CMBS Conditions and Limitations

In the following situations, the radar sensor or camera may be unable to correctly detect vehicles, pedestrians, moving bicycles, or road conditions, potentially causing the CMBS to operate improperly.

➤ **Front Sensor Camera** P. 585

➤ **Radar Sensor** P. 587

### ■ Environmental conditions

- Driving in bad weather (rain, fog, snow, etc.).
- Sudden changes between light and dark, such as an entrance or exit of a tunnel.
- There is little contrast between objects and the background.
- Driving into low sunlight (e.g., at dawn or dusk).
- Strong light is reflected onto a vehicle (including motorcycles), pedestrian, moving bicycle or roadway.
- Driving in the shadows of trees, buildings, etc.
- Roadway objects or structures are misinterpreted as vehicles and pedestrians.
- Reflections on the interior of the windscreen.
- Driving at night or in a dark place such as a tunnel (due to low-light conditions, vehicles [including motorcycles], pedestrians or moving bicycles may not be illuminated).
- When nearby radio wave emitting devices such as other automotive radar sensors.
- When driving for long distances on a road in a trafficless area such as a desert.

### ■ Roadway conditions

- Driving on a snowy or wet roadway (obscured lane marking, vehicle tracks, reflected lights, road spray, high contrast).
- Driving on curvy, winding, or undulating roads.
- The road is hilly or the vehicle is approaching the crest of a hill.

- Driving through an area where there are objects that strongly reflect radio waves onto a vehicle (including motorcycles), pedestrian or moving bicycle.
- Your vehicle is strongly shaken on uneven road surfaces.

#### ■ Vehicle conditions

- Headlight lenses are dirty or the headlights are not properly adjusted.
- The front of the camera is obstructed by dirt, fog, rain, mud, wet snow, accessories, decals, stickers, film, etc.
- The area around the front grille or front bumper is obstructed by dirt, rain, mud, wet snow, accessories, decals, stickers, film, etc.
- The inside of the windscreen is fogged.
- An abnormal tyre or wheel condition (incorrect sizes, varied sizes or construction, improperly inflated, etc.).
- When tyre chains are installed.
- The vehicle is tilted due to a heavy luggage or suspension modifications.
- The camera temperature gets too high.
- Driving with the parking brake applied.
- Driving at night or in a dark place (e.g., a tunnel) with the headlights off.
- There is residue on the windscreen from the windscreen wipers.
- Camera vision is blocked by drops of water from the window washer, or by the wiper blades.
- Operation of the vehicle is unstable due to a slippery road, etc.
- The vehicle is towing a trailer.

**■ Examples of limitations on the correct detection of the camera due to the condition of the vehicle ahead of you, vehicles approaching from the side, oncoming vehicles, pedestrians, or moving bicycles**

- The distance between your vehicle and the vehicle (including motorcycles) ahead of you, vehicle approaching from the side, oncoming vehicle, pedestrian, or moving bicycle ahead of you is too short.
- The vehicle (including motorcycles) ahead of you, oncoming vehicle, vehicle approaching from the side, pedestrian, or moving bicycle suddenly cuts in front of or jumps out in front of you.
- A bicycle or sideways-facing vehicle is stopped.
- The oncoming vehicle (including motorcycles) or vehicle ahead of you is sideways or facing diagonally.
- When the vehicle (including motorcycles) ahead of you, oncoming vehicle, vehicle approaching from the side, pedestrian, or moving bicycle blends in with the background, preventing the system from recognising them.
- When several pedestrians are moving ahead of you in a group.
- When several bicycles are moving ahead of you in a group.
- When a pedestrian or moving bicycle crosses the road too quickly.
- A pedestrian or moving bicycle approaches from the opposite direction.
- The headlights of the vehicle ahead of you or oncoming vehicle are lit on one side or not lit on either side in a dark place.
- When part of a pedestrian (heads, limbs, etc.) is hidden by carried object.
- When a pedestrian is bent over or squatting, when their hands are raised, or they are running.
- When the pedestrian is shorter than about 1 metre (3.3 feet) or taller than about 2 metres (6.6 feet) in height.
- When the pedestrian is pushing a stroller or bicycle.
- A vehicle is approaching diagonally from the side.
- A specially-shaped vehicle (such as a tank lorry or a lorry without a luggage) is approaching from the side.
- A vehicle approaching from the side is driving on a curve or hill.

**■ Examples of other limitations on detection or system operation**

- When the vehicle ahead of you is a small motorcycle, motorcycle with a sidecar, wheelchair, or other specially shaped vehicle.
- When a vehicle is lower in the rear than the front such as lorries that are not carrying a luggage, or a narrow vehicle.
- When the vehicle (including motorcycles) ahead of you, oncoming vehicle, pedestrian or moving bicycle is not in front of the vehicle.
- The speed difference between your vehicle (including motorcycles) and the vehicle ahead of you, oncoming vehicle, pedestrian or moving bicycle is significantly large.
- The speed difference between your vehicle and a vehicle, pedestrian, or moving bicycle approaching from the side is significantly large.
- When the vehicle (including motorcycles) or moving bicycle in front of you slows suddenly.
- When the driver operates the brake pedal and steering wheel to avoid a collision.
- When you approach the vehicle (including motorcycles) ahead of you, oncoming vehicle, vehicle approaching from the side, pedestrians or moving bicycles while accelerating rapidly or operating the steering wheel (except when turning left\*1/ right\*2 at an intersection, etc.)<sup>\*3</sup>
- When the moving bicycle is a child-sized bicycle, folding bicycle, three-wheeler or other bicycle with small tyres, or a long bicycle like a tandem bicycle.
- When the radar and camera cannot correctly identify the shape of the vehicle (including motorcycles) ahead of you, oncoming vehicle, pedestrian, or moving bicycle.
- When the minimum ground clearance of a vehicle that is ahead of you or approaching from the side is extremely high.
- When turning left or right and your turn signal is not activated in the same direction you are turning.

\*1: Left-hand Drive Type

\*2: Right-hand Drive Type

\*3: When there is a possibility of a frontal collision with the oncoming vehicle while turning left\*1 or right\*2, the CMBS is activated. However, it may not be activated if you suddenly turn the steering wheel.

### ■ Automatic shutoff

The CMBS may automatically shut itself off and the safety support indicator (amber) and Collision Mitigation Braking System (CMBS) indicator (amber) come and stay on when:

- You drive off-road or on a mountain road, or curved and winding road for an extended period.
- Driving in bad weather (rain, fog, snow, etc.).
- Driving with the parking brake applied.
- The camera temperature gets too high.
- The radar sensors temperature gets too high.
- The front of the camera or a radar sensor behind the Honda emblem or front bumper is obstructed by dirt, fog, rain, mud, wet snow, accessories, decals, stickers, film, etc.
- An abnormal tyre condition is detected (incorrect tyre size, flat tyre, etc.).
- You are driving near an object or place that generates strong radio waves or noise, such as a TV tower, broadcast station, power plant, or a vehicle equipped with radar.

Once the conditions that caused the CMBS to shut off improve or are addressed (e.g., cleaning), the system comes back on.

## ■ With Little Chance of a Collision

Even if there is little chance of a collision, the CMBS may activate under the following conditions.

Also, the system may activate if it detects a possibility of collision with pedestrians, moving bicycles, or vehicles.

- Your vehicle approaches or passes another vehicle that is making a left or right turn.
- Your vehicle approaches another vehicle ahead of you and you change lanes to pass.

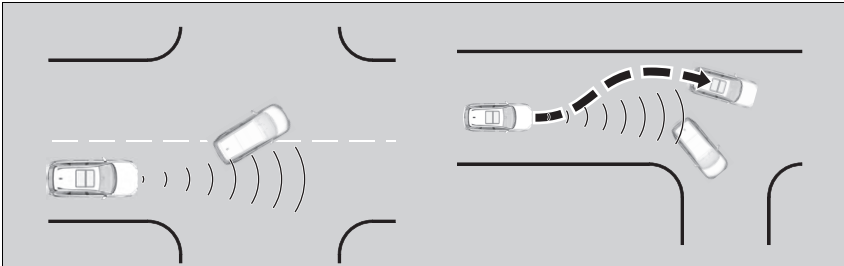

- When your vehicle approaches vehicles, pedestrians, or moving bicycles.
- When vehicles, pedestrians, or moving bicycles are passing in front of you.
- When you drive under a low structure or through a narrow gate at high speed.
- When you drive over roads with bumps, train tracks, or construction steel plates.
- When there are traffic signs or structures such as guard rails are beside the road along a curve.

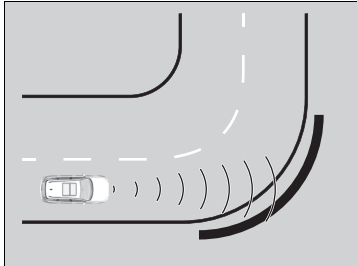

- When driving through curves, your vehicle comes to a point where the oncoming vehicle is right in front of you.

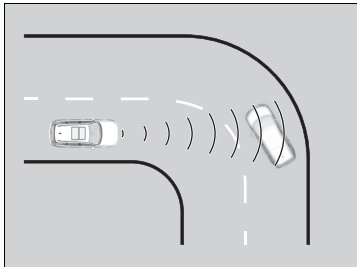

- When approaching stationary vehicles or walls, such as when parking.

- A vehicle approaches from the side as it is driving through a curve.
- You pass by a vehicle (including motorcycles), pedestrian, or bicycle that is turning left or right.
- You pass in front of a vehicle (including motorcycles), pedestrian, or bicycle that is approaching from the side.
- A vehicle (including motorcycles), pedestrian, or bicycle turns left or right while approaching your vehicle from the side.
- You attempt to pass in front of a vehicle (including motorcycles), pedestrian, or bicycle while you are turning left or right.
- A vehicle (including motorcycles), pedestrian, or bicycle is attempting to pass in front of your vehicle while you are turning left or right.
- A vehicle (including motorcycles), pedestrian, or bicycle enters the path of your vehicle and stops in front of you.
- When you are turning left or right, a crossing pedestrian enters the path of your vehicle and stops in front of you.
- You pass close by the side of a vehicle parked on the street.
- When you turn to avoid an obstacle in front of you, in situations such as when on a narrow road with a vehicle parked on the street in front of you, a pedestrian is near the side of your vehicle.
- When you are entering an oncoming lane (via a U-turn, etc.), a pedestrian is near the side of your vehicle.

## Low Speed Braking Control

Using sonar sensors located on the front and rear bumpers, this system can detect if there is danger of a potential collision with a wall or other obstacle during normal driving or when the accelerator pedal is depressed with too much force. The system then assists in avoiding collisions and reducing damage from impact through Low Speed Brake function and/or Collision Mitigation Throttle Control and Rear Collision Mitigation Throttle Control.

### ▶▶ Low Speed Braking Control

#### **WARNING**

The Low Speed Braking Control System cannot avoid all collisions and may not reduce damage in each situation where the accelerator is mistakenly or aggressively pressed. Overreliance on the system may result in a collision with serious injury or death. Always check your surroundings, your shift position, and your pedal use. Driver remains responsible for safely operating the vehicle.

If the Low Speed Braking Control activates in a situation where you do not want automatic brake application (such as when the vehicle is between two railroad crossing gates), simply press the brake pedal to deactivate the system and then continue to drive as intended.

If the system is activated by curbs/parking curbs or level differences on the road and you are unable to park or clear them, turn the system off.

## ■ How the System Works

### ■ Low Speed Brake function

The Low Speed Brake function provides a visual and audible alert when the vehicle is moving between approximately 2 and 10 km/h (1 and 6 mph) and there is the possibility of a collision with a detected wall or other obstacles, as well as providing assistance with braking.

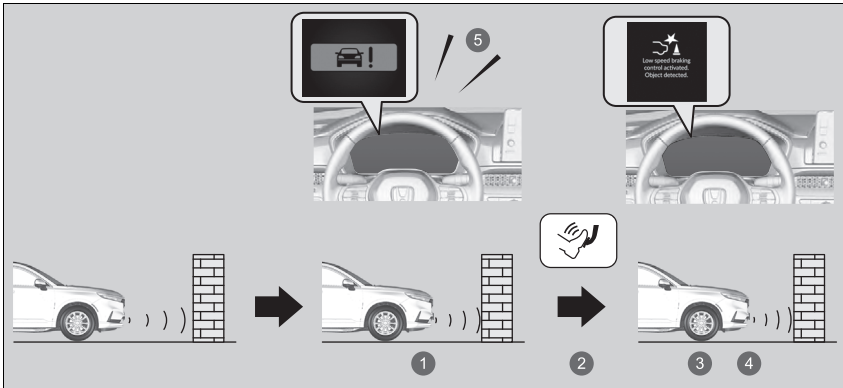

- ① The vehicle applies brake
- ② Driver depresses brake pedal
- ③ Stop
- ④ Remove brake after maintaining stationary position
- ⑤ Audible Alert

If only the rear parking sensors are turned off, the Low Speed Brake function will not work when reversing.

➤ **How to Customize the Vehicle Settings** P. 368

### ⊞ Low Speed Braking Control

For directions on the proper handling of the sonar sensors, please refer to the following page.

➤ **Sonar Sensors** P. 589

The vehicle will release the brake and start moving a few seconds after the system is activated. To keep the vehicle stopped, keep the brake pedal depressed or put the transmission into **P**.

In order to prevent the system from activating when not needed, always turn it off during vehicle maintenance, when loading on ships, trucks, and so on, or when using a chassis dynamometer or free rollers for inspection.

If you put any accessories on or around the rear sensors, the Low Speed Braking Control System may activate if it detects these accessories as an obstacle. In this case, turn off the rear sensor.

➤ **How to Customize the Vehicle Settings**  
P. 368

When the Drive Mode is changed to **TOW** mode, the Low Speed Braking Control System will not work when reversing.

➤ **Drive Mode Switch** P. 445

## ■ Collision Mitigation Throttle Control and Rear Collision Mitigation Throttle Control

When the vehicle is stopped or moving at less than 10 km/h (6 mph) and there is an obstacle such as a wall near the front of or back of the vehicle, if the accelerator pedal is depressed more than necessary, the system will inform you with a visual and audible alert. At the same time, the system will prevent sudden forward or backwards movement by limiting the output of the power system, then Low Speed Brake function will activate when you get closer to the obstacle.

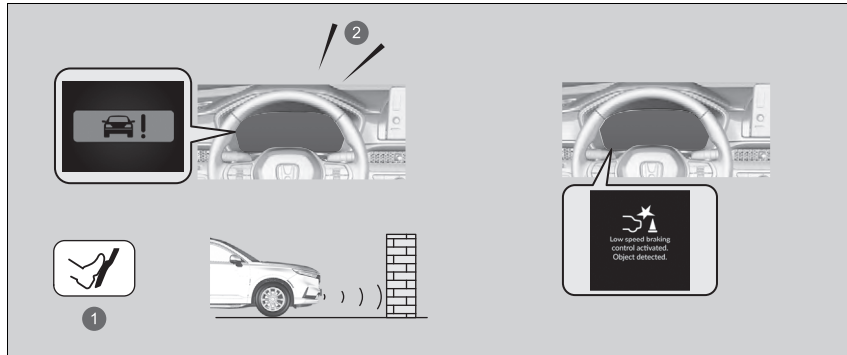

- 1 Accidental depression of the accelerator/Limiting the output of the power system
- 2 Audible Alert

Collision Mitigation Throttle Control and Rear Collision Mitigation Throttle Control will not activate in the following situations.

When moving forward:

When on a steep slope or the shift position is in **P**, **R**, or **N**.

When reversing:

When on a steep slope or the shift position is in a position other than **R**.

If only the rear parking sensors are turned off, the Collision Mitigation Throttle Control and Rear Collision Mitigation Throttle Control will not work when reversing.

🔧 **How to Customize the Vehicle Settings** P. 368

## ■ System On and Off

You can turn the system on and off using the driver information interface.

🔧 **Switching the Display** P. 164

🔧 **Safety Support** P. 173

The system is turned on every time you turn the power system on, even if you turned it off the last time you drove the vehicle.

### 🔧 System On and Off

The Low Speed Braking Control system may temporarily turn off after reconnecting the 12-volt battery.

The system will automatically turn ON after the vehicle has been moving at over 20 km/h (12 mph) for some time.

If the system does not turn on, have your vehicle checked by a dealer.

## ■ Conditions for Cancellation

### Conditions for Collision Mitigation Throttle Control, and Rear Collision Mitigation Throttle Control.

- When the accelerator is no longer depressed.
- When the accelerator is depressed for approximately four seconds.
- When the brake pedal is depressed.

### Conditions for Low Speed Brake function cancellation.

- A certain amount of time has passed since activation.

## ■ Low Speed Braking Control System Conditions and Limitations

The system may not operate correctly under the following conditions:

### ■ Examples of obstacles the sonar sensors cannot detect

- Obstacles that do not reflect sound waves well, such as people, snow, cloth, sponges, etc.
- Thin obstacles such as fences, bicycles, sign posts, etc.
- Short or small obstacles.
- Obstacles immediately in front of the bumper.
- Obstacles that are not perpendicular to the ground.
- Moving objects or obstacles that suddenly enter the road.

## ⊠ Conditions for Cancellation

After Low Speed Brake and Collision Mitigation Throttle Control have activated once, they will not activate again for the same obstacle. They can be activated again after driving for some time after the last activation.

Low Speed Braking Control activates separately when moving forward and reversing. (For example, if it activates when moving forward, it can be activated again immediately if reversing.)

However, if Low Speed Brake function has been activated, in order to activate Collision Mitigation Throttle Control and Rear Collision Mitigation Throttle Control again, it is necessary to drive for a certain distance to reset the system.

**■ Examples of situations where the sonar sensors cannot detect obstacles**

- The sonar sensors is dirty (covered by snow, water, mud, etc.).
- The vehicle is too hot or cold.
- The steering wheel is turned sharply when approaching the obstacle at an angle.

**■ Examples of other cases where the system may not work correctly**

- The vehicle is tilted due to heavy luggage or suspension modifications.
- Bad weather conditions such as heavy rain, fog, snow, sandstorms, etc.
- The ambient temperature/humidity is too high or low.
- When going down a very steep slope.
- When driving off-road such as on dirt, grass or rocks.
- When close to other vehicles with sonar sensors or other objects that emit ultrasonic waves.
- An abnormal tyre or wheel condition (incorrect sizes, varied sizes or construction, improperly inflated, etc.).

**■ Situations where the system may activate even without risk of a collision**

- When passing through short or narrow gates.
- When driving on uneven surfaces, grassy areas, or places with steps.
- When a sloped pillar or wall is protruding from a high position.
- When there are obstacles next to the road.
- When driving toward flags, curtains, tree branches, railroad crossing bars, etc.
- When driving on flooded roads.

## Front Cross Traffic Warning

Alerts you when the radar sensor or sensor camera detects a vehicle crossing in front of you.

### ■ How the System Activates

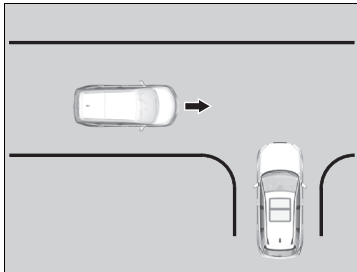

The system activates when all of the following conditions are met:

- The transmission is not in **P** or **R**.
- Your vehicle speed is around 16 km/h (10 mph) or less.
- A vehicle is crossing in front of you at a speed of about 10 km/h (6 mph) or higher.

### ⓘ Front Cross Traffic Warning

## ⚠ WARNING

Front Cross Traffic Warning cannot detect all approaching vehicles.

Always visually confirm that it is safe to drive, use your mirrors, and look forward and to the sides before moving your vehicle.

Under certain conditions, the system may not detect an approaching vehicle at all. Relying only on the system's audible or visual alerts may result in a collision.

For directions on the proper handling of the radar sensor, refer to the following page.

➔ **Radar Sensor** P. 587

You can read about handling information for the camera equipped with this system.

➔ **Front Sensor Camera** P. 585

Front Cross Traffic Warning is not activated for about 15 seconds after the power system is turned on.

### ⓘ How the System Activates

The system may alert for pedestrians, bicycles, motorcycles, or scooters.

Front Cross Traffic Warning does not activate until you have driven a certain distance after starting the vehicle.

## ■ When the System Detects a Vehicle

While the system detects a crossing vehicle, vehicle detection arrows are displayed on the head-up display\* as well as the audio/information screen.



- ① Head-up Display\*
- ② Audio/information Screen
- ③ Arrow Icon

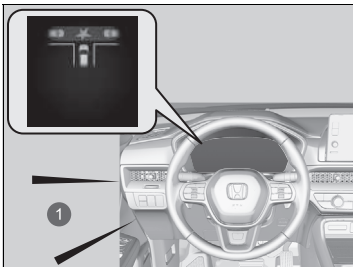

- ① Beep

When a crossing vehicle is detected, and the system has determined that your vehicle is in motion, visual and audible warnings will be provided on the gauge in addition to the items above.

## ▶▶ When the System Detects a Vehicle

You can turn the vehicle detection arrows on and off from the audio/information screen.

- ▶ **How to Customize the Vehicle Settings**  
P. 368

\* Not available on all models

## ■ Front Cross Traffic Warning On and Off

You can turn the system on and off using the driver information interface.

▶ **Switching the Display** P. 164



▶ **Safety Support** P. 173



Front Cross Traffic Warning is turned on every time you turn the power system on, even if you turned it off the last time you drove the vehicle.

By pressing  (Front Cross Traffic Warning Icon), you can turn vehicle detection arrows on and off on the audio/information screen.

Vehicle detection arrows are in the previously selected on or off setting each time you turn the power system on.

## ▶▶ Front Cross Traffic Warning On and Off

If  changes to  on the audio/information screen, mud, snow or ice, etc. may have accumulated in the vicinity of the front bumper or Honda emblem. The system is temporarily cancelled. Check the front bumper corners and the Honda emblem for any obstructions, and thoroughly clean the area if necessary.

If  is displayed on the audio/information screen, or  does not appear while displaying frontal views with the Multi-View Camera, there may be a problem with the system. Do not use the system and have your vehicle checked by a dealer.

## ■ Front Cross Traffic Warning Conditions and Limitations

Under the following conditions, the system may not function properly, or it may activate when you do not want it to.

📷 **Front Sensor Camera** P. 585

📷 **Radar Sensor** P. 587

### ■ Environmental conditions

- Driving in bad weather (rain, fog, snow, etc.).
- When there are structures such as fences in between your vehicle and the crossing vehicle.
- The system picks up signal interference such as other radar sensors from another vehicle or strong radio wave transmitted from a facility nearby.
- Reflections on the interior of the windscreen.
- You are driving on an open road with no nearby structures.

### ■ Roadway conditions

- Your vehicle or the crossing vehicle is driving on a curve or slope.
- There are objects around your vehicle that reflect radio waves strongly.

### ■ Vehicle conditions

- The area around the front grille, front bumper, or rear bumper is obstructed by dirt, rain, mud, wet snow, accessories, decals, stickers, film, etc.
- The vehicle is tilted due to a heavy luggage in the luggage area or rear seats.
- Driving on rough or unpaved roads, or over bumpy surfaces.
- Driving on snowy or slippery roads.
- When nearby radio wave emitting devices such as other automotive radar sensors.
- The camera temperature gets too high.
- The inside of the windscreen is fogged.

*Continued*

### ■ Target Conditions

- The crossing vehicle is short or small.
- The crossing vehicle has very high ground clearance.
- The crossing vehicle is specially shaped.
- The crossing vehicle's speed is too high.
- The approaching target is a pedestrian, bicycle, or motorcycle.

### ■ Other conditions

- The crossing vehicle passes through the space between your vehicle and the vehicle in front of you.
- The crossing vehicle approaches the front of your vehicle diagonally.
- Your vehicle or the crossing vehicle suddenly cuts into the intersecting lane from a parking lot, etc.
- Your vehicle or the crossing vehicle slows suddenly.
- Your vehicle or the crossing vehicle suddenly accelerates or turns.
- The crossing vehicle is too far ahead of your vehicle.
- You are passing by the side of a stopped vehicle.
- Your vehicle is too close to roadside structures (such as guardrails, telephone poles, trees, buildings, walls, etc.).
- Movement of a pedestrian or vehicle is detected on a nearby sidewalk or parking lot.
- The crossing vehicle turns left or right, or stops in front of your vehicle.
- The crossing vehicle pass through in behind of your vehicle.
- Your vehicle passes through the intersection before the crossing vehicle does.
- A vehicle passes through a lane separated from your vehicle by an object such as a median barrier.
- A vehicle approaches your vehicle while it is stopped at a traffic light.

- A vehicle or pedestrian approaches your vehicle from your lane.
- You are passing by an oncoming vehicle, or a vehicle is driving parallel to you or merging into your lane.
- An object such as a monorail is detected moving on an overpass in front of you.
- You are passing by splashes, etc.

## Road Departure Mitigation System

Alerts and helps to assist you when the system detects a possibility of your vehicle crossing over detected lane markings, or approaching the outer edge of the pavement (into grass or gravel road shoulder) or a detected oncoming vehicle.

### ■ How the System Works

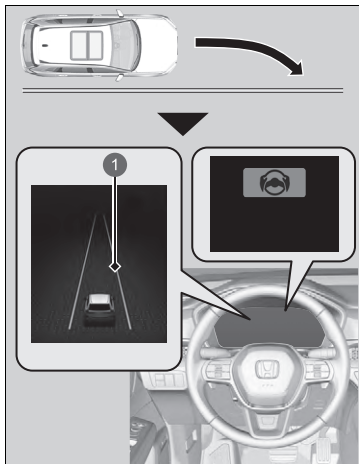

① Amber line

The front camera behind the rearview mirror monitors left and right lane markings in white or yellow, the outer edge of the pavement (into grass or gravel road shoulder) or a detected oncoming vehicle.

If your vehicle approaches any detected lane markings, the outer edge of the pavement (into grass or gravel road shoulder) or a detected oncoming vehicle when the turn signals have not been engaged, the system activates.

- ▶ If the system cannot detect lane markings (in white or yellow), no assistance will be provided to avoid approaching oncoming vehicles. In addition to a visual alert, the system assists with steering and alerts you with rapid steering wheel vibrations to help you remain within the detected lane.

#### ▶ How to Customize the Vehicle Settings

P. 368

As a visual alert, the  **Lane departure** message appears on the driver information interface.

### ▶▶ Road Departure Mitigation System

#### Important Safety Reminder

Like all assistance systems, the Road Departure Mitigation system has limitations.

Overreliance on the Road Departure Mitigation system may result in a collision. It is always your responsibility to keep the vehicle within your driving lane.

The Road Departure Mitigation system alerts you when the system detects that you are approaching the outer edge of the pavement (into grass or gravel road shoulder), an oncoming vehicle, or drifting into another lane without using a turn signal.

The Road Departure Mitigation system may not detect all lane markings or every instance of lane drift.

The Road Departure Mitigation system may not detect that you are approaching the outer edge of the pavement (into grass or gravel road shoulder) or an oncoming vehicle.

The Road Departure Mitigation system may not be able to assist you depending on weather, speed or road conditions.

You can read about handling information for the camera equipped with this system.

#### ▶▶ Front Sensor Camera P. 585

The Road Departure Mitigation system is not activated for about 15 seconds after the power system is turned on.

The system cancels assisting operations when you turn the steering wheel to avoid crossing over detected lane markings or approaching the outer edge of the pavement (into grass or gravel road shoulder) or an oncoming vehicle.

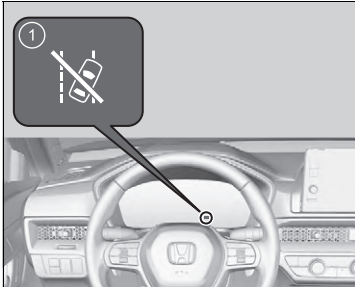

- ① Road Departure Mitigation System Steering Assist Auto OFF indicator

If the system operates several times without detecting driver response, the system beeps to alert you. After that, the Road Departure Mitigation System Steering Assist Auto OFF indicator comes on, the Road Departure Mitigation steering assist is temporarily stopped, and the system will only alert you with the warning sound.

After a few minutes, the Road Departure Mitigation System Steering Assist Auto OFF indicator goes off and the Road Departure Mitigation system is fully restored.

#### ⊠ Road Departure Mitigation System

The Road Departure Mitigation system may not work properly or may work improperly under the certain conditions:

#### ⊠ Road Departure Mitigation system Conditions and Limitations P. 514

There are times when you may not notice the Road Departure Mitigation system functions due to your operation of the vehicle, or road surface conditions.

You can change the settings for the Road Departure Mitigation system.

If LKAS or Traffic Jam Assist is off, the message below may appear if the system has determined that there is a possibility of your vehicle crossing over detected lane markings, the outer edge of the pavement (into grass or gravel road shoulder) or oncoming vehicle.

#### ⊠ How to Customize the Vehicle Settings P. 368

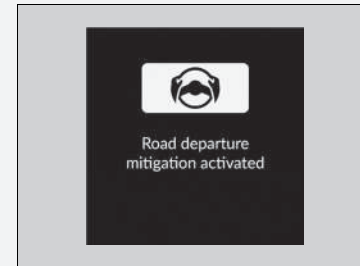

Continued

## ■ How the System Activates

The system activates when all of the following conditions are met:

- The vehicle is on a straight or slightly curved road.
- The turn signals are off.
- The system makes a determination that the driver is not actively accelerating, braking, or steering.
- The lane markings is white (yellow).  
The vehicle is travelling between about 72 and 180 km/h (45 and 112 mph).
  - ▶ When oncoming vehicles are running  
The vehicle is travelling between about 30 and 180 km/h (18 and 112 mph).
- The outer edge of the pavement is grass or gravel road shoulder.  
The vehicle is travelling between about 30 and 180 km/h (18 and 112 mph).

## ▶▶ How the System Activates

The Road Departure Mitigation system may automatically shut off and the safety support indicator (amber) and Road Departure Mitigation indicator (amber) comes and stays on.

### ▶▶ Indicators P. 116

The Road Departure Mitigation system function can be impacted when the vehicle is:

- Driven on the inside edge of a curve, or outside of a lane.
- Driven in a narrow lane.

## Road Departure Mitigation system On and Off

You can turn the system on and off using the driver information interface.

🗨 **Switching the Display** P. 164

🛡 **Safety Support** P. 173

The Road Departure Mitigation system is turned on every time you turn the power system on, even if you turned it off the last time you drove the vehicle.

### 🗨 Road Departure Mitigation system On and Off

The Vehicle Stability Assist (VSA) system, brake system (Amber), Adaptive Cruise Control (ACC) with Low Speed Follow, low tyre pressure/deflation warning system, Collision Mitigation Braking System (CMBS), Road Departure Mitigation and safety support indicators may come on in amber along with a message in the gauge when you set the power mode to ON after reconnecting the 12-volt battery. Drive a short distance at more than 20 km/h (12 mph). Each indicator should go off. If any do not, have your vehicle checked by a dealer.

*Continued*

## ■ Road Departure Mitigation system Conditions and Limitations

The system may not properly detect lane markings (in white or yellow), the outer edge of the pavement (into grass or gravel road shoulder) or an oncoming vehicle; and the system may not function properly under certain conditions, including the following:

### ■ Environmental conditions

- There is little contrast between lane lines and the roadway surface.
- Driving in bad weather (rain, fog, snow, etc.).
- Driving on a snowy or wet roadway.
- Driving into low sunlight (e.g., at dawn or dusk).
- Shadows of adjacent objects (trees, buildings, guard rails, vehicles, etc.) are parallel to white (or yellow) lines.
- Sudden changes between light and dark, such as the entrance or exit of a tunnel or the shadows of trees, buildings, etc.
- Strong light is reflected onto the roadway.
- Driving at night or in a dark place such as a tunnel (due to low-light conditions, lane lines, the road surface, or oncoming vehicles may not be illuminated).
- The distance between your vehicle and the vehicle ahead of you is too short, and lane lines and the road surface are not visible.
- The outer edge of the road is bordered by objects, materials, etc. other than grass or gravel.
- Reflections on the interior of the windshield.
- The system picks up signal interference such as other radar sensors from another vehicle or strong radio wave transmitted from a facility nearby.
- When nearby radio wave emitting devices such as other automotive radar sensors.

**■ Roadway conditions**

- Driving on a road with temporary lane markings.
- Faint, multiple, or varied lane markings are visible on the roadway due to road repairs or deteriorated lane markings.
- The roadway has merging, split, or crossing lines, such as at an intersection or crosswalk.
- The lane markings are extremely narrow, wide, or changing.
- Part of the lane markings are hidden by an object, such as a vehicle.
- The road is hilly or the vehicle is approaching the crest of a hill.
- Your vehicle is strongly shaken on uneven road surfaces.
- When objects on the road (curb, guard rail, pylons, etc.) are recognised as white (or yellow) lines.
- Driving on rough or unpaved roads, or over bumpy surfaces.
- Driving on roads with double lane lines.
- Driving on snowy or slippery roads.
- Passing through a junction.
- The pavement is only partially visible due to snow or puddles on the road.
- Driving on unpaved or rutted roads.
- White (or yellow) lines are not recognised correctly due to road conditions such as curves, twists, or hills.
- There are objects around your vehicle that reflect radio waves strongly, such as when driving through a narrow metal bridge.

■ **Vehicle conditions**

- When lighting is weak due to dirt covering the headlight lenses, or there is poor visibility in a dark place due to the headlights being improperly adjusted.
- The front of the camera is obstructed by dirt, fog, rain, mud, wet snow, accessories, decals, stickers, film, etc.
- Driving at night or in a dark place (e.g., a tunnel) with the headlights off.
- When the driver operates the brake pedal and steering wheel.
- There is residue on the windscreen from the windscreen wipers.
- An abnormal tyre or wheel condition (incorrect sizes, varied sizes or construction, improperly inflated, etc.).
- The vehicle is tilted due to heavy luggage in the luggage area or rear seats.
- Tyre chains are installed.
- The suspension has been modified.
- The vehicle is towing a trailer.
- The camera temperature gets too high.
- The inside of the windscreen is fogged.
- The area around the front grille or front bumper is obstructed by dirt, rain, mud, wet snow, accessories, decals, stickers, film, etc.

### ■ Examples of limitations on detection due to the condition of oncoming vehicles

- The oncoming vehicle or vehicle ahead of you is sideways.
- The oncoming vehicle jumps out in front of you.
- When the oncoming vehicle blends in with the background, preventing the system from recognising it.
- The headlights of an oncoming vehicle are lit on one side or not lit on either side in a dark place.
- The distance between your vehicle and the oncoming vehicle is too short.
- Part of the oncoming vehicle is not visible due to the vehicle ahead of you.
- There are multiple oncoming lanes or turning lanes.
- The vehicle in the adjacent lane is parked or moving at an extremely slow speed.
- When the minimum ground clearance of an oncoming vehicle is extremely high.
- Objects (guard rails, poles, trees, parked cars, buildings, walls, etc.) are detected.

### ■ Examples of other limitations on detection or system operation

- When the oncoming vehicle is specially-shaped.
- When the camera cannot correctly identify the shape of the oncoming vehicle.
- You drive on a curved or winding or undulating road that makes it difficult for the sensor to properly detect an oncoming vehicle.

### ■ With Little Chance of a Collision

The Road Departure Mitigation system may activate in the below conditions.

- When driving through curves, your vehicle comes to a point where an oncoming vehicle is right in front of you.

## Lane Change Collision Mitigation

When you change lanes, the system gives visual and audible alerts, along with steering assistance, if it detects the risk of a vehicle colliding with yours from a rear corner.

### ■ How the System Works

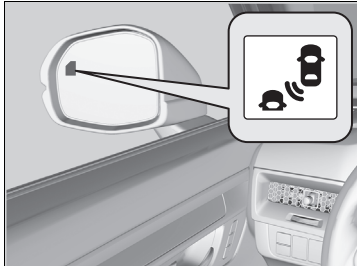

When the following conditions are met and you are making a lane change where there is a risk of collision with a vehicle in the adjacent lane approaching from behind, the Lane Change Collision Mitigation indicator blinks, audible and visual alerts are given, and the system assists steering for collision avoidance.

- The vehicle is moving at a speed between about 50 km/h and 180 km/h (31 mph and 112 mph).
- You are driving in the centre of a lane with lane markers to the left and right of your vehicle.
- Lane markers are detected to the left and right of your vehicle.
- You are driving on a straight or slightly curved road.
- When a vehicle is trying to pass you: The speed difference between your vehicle and the vehicle approaching from behind is no more than 50 km/h (31 mph).
- When you have passed a vehicle: The speed difference between your vehicle and the vehicle you passed is no more than 14 km/h (8 mph).

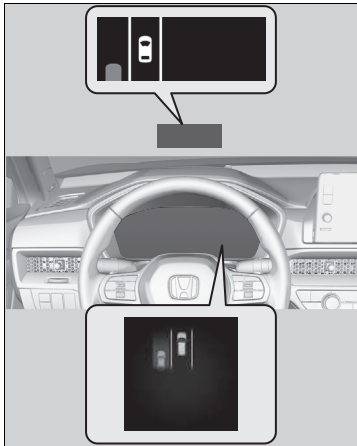

### ▶ Lane Change Collision Mitigation

## ⚠ WARNING

Like all assistance systems, Lane Change Collision Mitigation has limitations. It cannot avoid all collisions and may not reduce damage in all situations.

**Overreliance on the system may result in a collision with serious injury or death. Carefully check your surroundings and operate your vehicle safely.**

Lane Change Collision Mitigation is not activated for about 15 seconds after the power system is turned on.

For directions on the proper handling of the radar sensor, refer to the following page.

▶ **Radar Sensor** P. 587

You can read about handling information for the camera equipped with this system.

▶ **Front Sensor Camera** P. 585

Turn the system off when towing a trailer.

The system may not work properly for the following reasons:

- The added mass tilts the vehicle and changes the radar coverage.
- The radar sensor detects the trailer itself, causing radar coverage to be changed.

When the driver takes full control of the steering, the Lane Change Collision Mitigation function is temporarily cancelled.

### ■ Lane Change Collision Mitigation Range

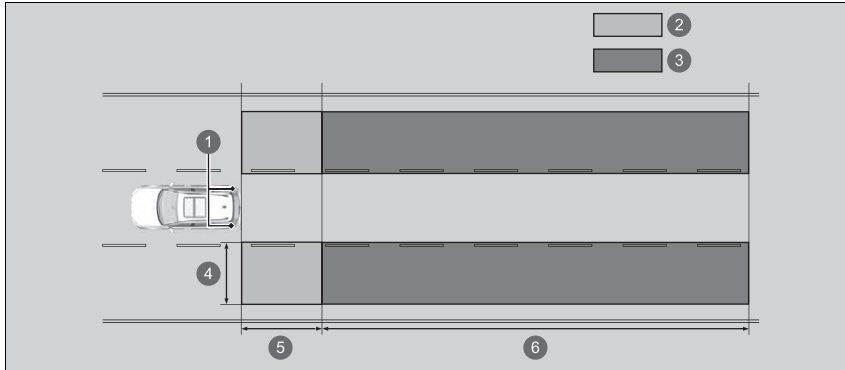

- ① Radar Sensors: underneath the rear bumper corners
- ② Alert Zone 1
- ③ Alert Zone 2
- Alert zone range
- ④ Approx. 0.5 ~ 3 m (1.6 ~ 10 ft.) from vehicle side.
- ⑤ Approx. 3 m (10 ft.) from rear bumper.
- ⑥ Approx. 3 ~ 50 m (10 ~ 164 ft.) behind from rear bumper. (The faster the approaching vehicle, the further away it will be detected.)

## ■ Lane Change Collision Mitigation On and Off

You can turn the system on and off using the driver information interface.

➤ **Switching the Display** P. 164

➤ **Safety Support** P. 173

The Lane Change Collision Mitigation is in the previously selected on or off setting each time you turn the power system on.

## ■ Lane Change Collision Mitigation Conditions and Limitations

The Lane Change Collision Mitigation indicator may not come on under the following conditions:

- An object not detected by the radar sensors approaches or passes your vehicle.

The system may not operate correctly under the following conditions:

- An object that does not reflect radio waves well, such as a motorcycle, is in the alert zone.
- The rear bumper or the sensors have been improperly repaired or the rear bumper has been deformed.

The system may not activate or may not detect a vehicle under the following conditions:

- You change lanes immediately after passing a vehicle in the adjacent lane.
- You are driving over the lane line on the inside of a curve.
- Large luggage on the roof is touching the upper part of the windscreen.
- Making a turn at an intersection.
- Your vehicle or a vehicle around you is driving too far to one side of the lane.

## ☒ Lane Change Collision Mitigation On and Off

You can change the settings for the Lane Change Collision Mitigation system.

➤ **How to Customize the Vehicle Settings**  
P. 368

When the Drive Mode is changed to **TOW** mode, the Lane Change Collision Mitigation will turn off.

➤ **Drive Mode Switch** P. 445

The system may not activate or may not detect lanes or vehicles under the following conditions.

### ■ Environmental conditions

- There is little contrast between lane lines and the roadway surface.
- Driving in bad weather (rain, fog, snow, etc.).
- Driving on a snowy or wet roadway.
- Driving into low sunlight (e.g., at dawn or dusk).
- Shadows of adjacent objects (trees, buildings, guard rails, vehicles, etc.) are parallel to white (or yellow) lines.
- Sudden changes between light and dark, such as the entrance or exit of a tunnel or the shadows of trees, buildings, etc.
- Driving at night or in a dark place such as a tunnel (due to low-light conditions, lane lines or the road surface may not be illuminated).
- When the lane lines or road surface are not visible, such as when the distance to the vehicle in front of you is extremely short.
- Strong light is reflected onto the roadway.
- Water is being splashed or snow is being flung by the preceding vehicle.
- The system picks up signal interference such as other radar sensors from another vehicle or strong radio wave transmitted from a facility nearby.
- Strong light such as sunlight is directly or indirectly shining onto the front sensor camera.
- When nearby radio wave emitting devices such as other automotive radar sensors.
- When driving for long distances on a road in a trafficless area such as a desert.

### ■ Roadway conditions

- Driving on a road with temporary lane markings.
- Faint, multiple, or varied lane markings are visible on the roadway due to road repairs or old lane markings.
- The roadway has merging, split, or crossing lines, such as at an intersection or crosswalk.
- The lane markings are extremely narrow, wide, or changing.
- Part of the lane markings are hidden by an object, such as a vehicle.
- The road is hilly or the vehicle is approaching the crest of a hill.
- Your vehicle is strongly shaken on uneven road surfaces.
- When objects on the road (curb, guard rail, pylons, etc.) are recognised as white (or yellow) lines.
- Driving on rough or unpaved roads, or over bumpy surfaces.
- Driving on roads with double lane lines.
- Driving on snowy or slippery roads.
- The pavement is only partially visible due to snow or puddles on the road.
- There is a film of water or puddles on the road surface.
- White (or yellow) lines are not recognised correctly due to road conditions such as curves, twists, or hills.
- Driving on unpaved or rutted roads.
- Passing through a junction.
- There are objects around your vehicle that reflect radio waves strongly, such as when driving through a tunnel or a narrow metal bridge.
- Objects (guard rails, poles, trees, parked cars, buildings, walls, etc.) are detected.

**■ Vehicle conditions**

- When lighting is weak due to dirt covering the headlight lenses, or there is poor visibility in a dark place due to the headlights being improperly adjusted.
- The front of the camera is obstructed by dirt, fog, rain, mud, wet snow, accessories, decals, stickers, film, etc.
- The area around the front grille, front bumper or rear bumper is obstructed by dirt, rain, mud, wet snow, accessories, decals, stickers, film, etc.
- Driving at night or in a dark place (e.g., a tunnel) with the headlights off.
- There is residue on the windscreen from the windscreen wipers.
- An abnormal tyre or wheel condition (incorrect sizes, varied sizes or construction, improperly inflated, etc.).
- The vehicle is tilted due to heavy luggage in the luggage area or rear seats.
- The suspension has been modified.
- Tyre chains are installed.
- An object such as a bicycle rack is attached to the rear of the vehicle.
- The camera temperature gets too high.
- Operation of the vehicle is unstable due to a slippery road, etc.
- Your vehicle is strongly shaken on uneven road surfaces.
- The vehicle is towing a trailer.

**■ Surrounding vehicle conditions**

- The interval between your vehicle and the vehicle around you is too short.
- There is a large speed difference between your vehicle and the vehicle in the adjacent lane.
- When the vehicle around you is specially-shaped.
- When the minimum ground clearance of a vehicle ahead of you is extremely high.
- When a vehicle is lower in the rear than the front such as lorries that are not carrying a luggage, or a narrow vehicle.

■ **Examples of other limitations on detection or system operation**

- A vehicle is parked in an adjacent lane.
- A vehicle is moving from a far lane to the adjacent lane.
- A vehicle running in the adjacent lane is a motorcycle or other small vehicle.
- You change lanes immediately after passing a vehicle in the adjacent lane.
- When there is a risk of colliding with another vehicle (including motorcycles) while the system is assisting you with avoiding a collision with a vehicle approaching from the rear corner.

## Driver Attention Monitor

The Driver Attention Monitor detects the driver's condition using the driver monitoring camera, and then depending on the situation will recommend caution or a break. If you feel sleepy or fatigued, stop in a safe location and rest for as long as needed.



A message is displayed when the driver monitoring camera detects that the driver is sleepy.



If the system determines that the driver is very sleepy, a message (amber) is displayed, and a warning alert sounds.

Roll the right selector wheel to erase the message.

- ▶ If this message is displayed, stop in a safe location and rest for as long as needed.



If the driver monitoring camera detects that the driver is looking to the side, a message (amber) is displayed, and a warning alert sounds.

Pay attention to the road ahead when driving.

- ▶ This message does not appear when you are driving at a low speed.

### Driver Attention Monitor

The system will not operate if the driver monitoring camera cannot correctly detect the driver. The system may not correctly detect whether the driver is sleepy or looking to the side.

You can toggle the Driver Attention Monitor on and off in **Driver attention monitor**.

- ▶ **How to Customize the Vehicle Settings**  
P. 368

You can read about handling information for the Driver Monitoring Camera equipped with this system.

- ▶ **Driver Monitoring Camera** P. 588

## Adaptive Cruise Control (ACC) with Low Speed Follow

Helps to maintain a constant vehicle speed and a set following-interval behind a vehicle detected ahead of yours and, if the detected vehicle comes to a stop, can decelerate and stop your vehicle, without you having to keep your foot on the brake or the accelerator.

When ACC with Low Speed Follow slows your vehicle by applying the brakes, your vehicle's brake lights will illuminate.

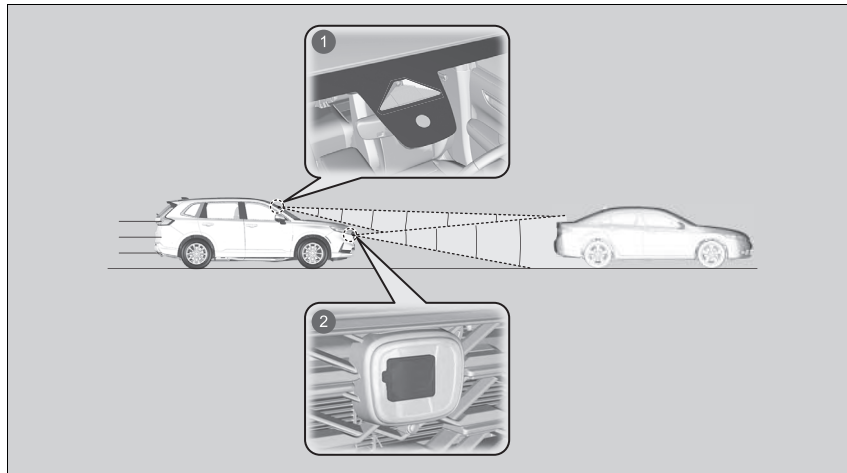

- 1 A front sensor camera is located behind the rearview mirror.
- 2 The radar sensor is behind the Honda emblem on the front grille.

### ▶ Adaptive Cruise Control (ACC) with Low Speed Follow

#### **⚠ WARNING**

Improper use of ACC with Low Speed Follow can lead to a crash.

Use ACC with Low Speed Follow only when driving on motorways and in good road and weather conditions.

#### **⚠ WARNING**

ACC with Low Speed Follow has limited braking capability and may not stop your vehicle in time to avoid a collision with a vehicle that quickly stops in front of you.

Always be prepared to apply the brake pedal if the conditions require.

#### **⚠ WARNING**

Exiting a vehicle that has been stopped while the ACC with Low Speed Follow system is operating can result in the vehicle moving without operator control.

A vehicle that moves without operator control can cause a crash, resulting in serious injury or death.

Never exit a vehicle when the vehicle is stopped by ACC with Low Speed Follow.

- Vehicle speed for ACC with Low Speed Follow: **A vehicle is detected ahead within ACC with Low Speed Follow range** – ACC with Low Speed Follow operates at speeds up to 180 km/h (112 mph).  
**No vehicle is detected within ACC with Low Speed Follow range** – ACC with Low Speed Follow operates at the speed of 30 km/h (18 mph) or above.
- Shift position for ACC with Low Speed Follow: In **[D]**.

### ■ How to activate the system

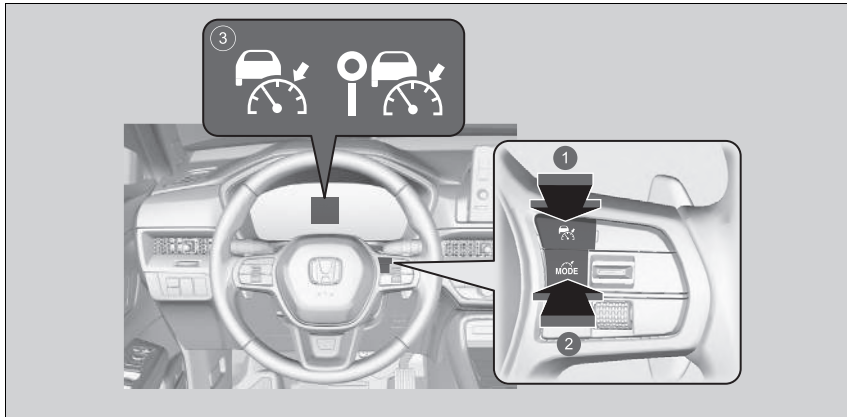

- 1 Button  
Press the button on the steering wheel.
- 2 Button  
If a different indicator is displayed, press the button to change it to ACC with Low Speed Follow.
- 3 or (white) is on in the gauge. ACC with Low Speed Follow is ready to use.

### ▣ Adaptive Cruise Control (ACC) with Low Speed Follow

#### Important Reminder

As with any system, there are limits to ACC with Low Speed Follow. Use the brake pedal whenever necessary, and always keep a safe interval between your vehicle and other vehicles.

ACC with Low Speed Following is not activated for about 15 seconds after the power system is turned on.

For directions on the proper handling of the radar sensor, refer to the following page.

➤ **Radar Sensor** P. 587

You can read about handling information for the camera equipped with this system.

➤ **Front Sensor Camera** P. 585

The radar sensor for ACC with Low Speed Follow is shared with the Collision Mitigation Braking System (CMBS).

➤ **Collision Mitigation Braking System (CMBS)** P. 484

ACC with Low Speed Follow may not work properly under certain conditions.

➤ **ACC with Low Speed Follow Conditions and Limitations** P. 535

When not using ACC with Low Speed Follow: Turn off adaptive cruise by pressing the button.

Continued

## ■ To Set the Vehicle Speed

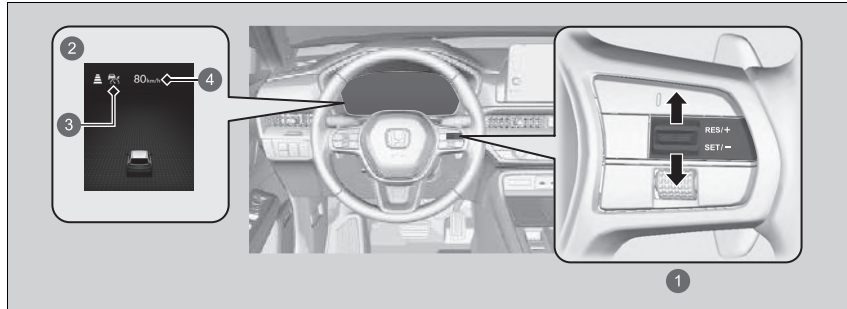

- 1 **RES/+SET/-** Switch  
Up or down
- 2 On when ACC with Low Speed Follow begins
- 3 or (green)
- 4 Set Vehicle Speed

**When driving at about 30 km/h (18 mph) or above:** Take your foot off the pedal and press the **RES/+SET/-** switch up or down when you reach the desired speed. The moment you release the **RES/+SET/-** switch, the set speed is fixed, and ACC with Low Speed Follow begins.

## ▣ Adaptive Cruise Control (ACC) with Low Speed Follow

Do not use ACC with Low Speed Follow under the following conditions:

- On roads with frequent lane-change or continuous stop and go traffic, ACC with Low Speed Follow cannot keep an appropriate distance between your vehicle and the vehicle ahead of you.
- On roads with sharp turns.
- On roads with toll collection facilities or other objects between lanes of traffic, or in parking areas, or facilities with drive through access.
- On roads with bad weather (rain, fog, snow, etc.), ACC with Low Speed Follow may not detect the distance between your vehicle and the vehicle ahead of you properly.
- On roads with slippery or icy surfaces. The wheels may spin out and your vehicle may lose the control on the condition.
- On roads with steep uphill or steep downhill slopes.
- On roads with undulating slopes.



The Vehicle Stability Assist (VSA) system, brake system (Amber), Adaptive Cruise Control (ACC) with Low Speed Follow, low tyre pressure/deflation warning system, Collision Mitigation Braking System (CMBS), Road Departure Mitigation and safety support indicators may come on in amber along with a message in the gauge when you set the power mode to ON after reconnecting the 12-volt battery. Drive a short distance at more than 20 km/h (12 mph). Each indicator should go off. If any do not, have your vehicle checked by a dealer.

When you use ACC with Low Speed Follow, Straight Driving Assist (a feature of the Electric Power Steering system) is activated.

By enabling the steering system to automatically compensate for natural steering pull, Straight Driving Assist makes it easier for you to keep your vehicle in a straight line.

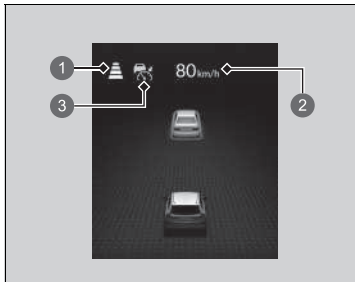
**When driving slower than about 30 km/h (18 mph):** If the vehicle is moving and the brake pedal is not depressed, pressing the switch fixes the set speed to about 30 km/h (18 mph) regardless of current vehicle speed. If your vehicle is stationary, you can set the vehicle speed even with the brake pedal depressed.



- ① Set Vehicle Interval
- ② Set Vehicle Speed
- ③  or  (green)

When ACC with Low Speed Follow starts operating, the vehicle icon, interval bars and set speed appear on the gauge.

#### ▶▶ To Set the Vehicle Speed

You can switch the displayed set speed measurements on the driver information interface or audio/information screen between km/h and mph.

▶ **Speed/Distance Units** P. 175

▶ **How to Customize the Vehicle Settings**  
P. 368

## ■ Applying the Traffic Sign Recognition System's Suggested Speed Limit

When  is displayed, the speed limit suggested by the Traffic Sign Recognition System may be applied pressing the **RES/+ / SET/-** switch down on the steering wheel.

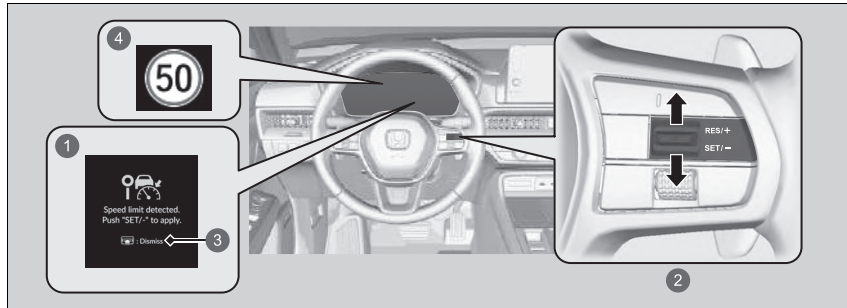

- ① Suggestion prompt to apply detected speed limit
- ② Apply the Traffic Sign Recognition System's suggested speed limit
- ③ Dismiss suggestion prompt
- ④ Suggested speed limit (green)

A suggested speed limit is displayed whenever a new speed limit is detected by the Traffic Sign Recognition System, or if a speed limit is detected by it when ACC with Low Speed Follow is activated.

The **RES/+ / SET/-** switch will not function to decrease vehicle speed until the suggestion prompt is dismissed.

## ▶▶ Applying the Traffic Sign Recognition System's Suggested Speed Limit

The suggested speed limit may be above or below the actual speed limit, or there may be no suggestion. This will occur particularly when the traffic sign recognition system does not operate correctly. It is your responsibility to adjust the speed to obey the actual speed limit and safely operate the vehicle.

### ▶▶ Traffic Sign Recognition System Conditions and Limitations P. 579

Do not use this function in areas of different units from the display unit of ACC with Low Speed Follow because an inappropriate vehicle speed may be suggested.

Change the displayed measurement of the set vehicle speed to the same units as the driving areas.

### ▶▶ Speed/Distance Units P. 175

### ▶▶ How to Customize the Vehicle Settings P. 368

Traffic Sign Recognition System display is turned off. Keep the Traffic Sign Recognition System display on at all times when using this function.

### ▶▶ How to Customize the Vehicle Settings P. 368

## ■ When in Operation

### ■ There is a vehicle ahead

ACC with Low Speed Follow monitors if a vehicle ahead of you enters the ACC with Low Speed Follow range. If a vehicle is detected doing so, the ACC with Low Speed Follow system maintains or decelerates your vehicle's set speed in order to keep the vehicle's set following-interval from the vehicle ahead.

🔧 **To Set or Change Following-interval** P. 544

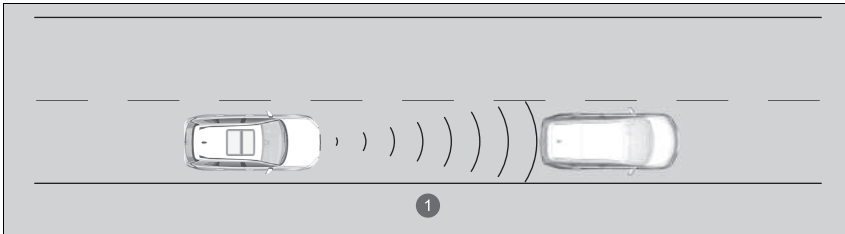

① ACC with Low Speed Follow Range: 120 m (394 ft.)

## 🔍 When in Operation

If the vehicle ahead of you slows down abruptly, or if another vehicle cuts in front of you, a beeper sounds, a message appears on the driver information interface, and the head-up warning lights flash.

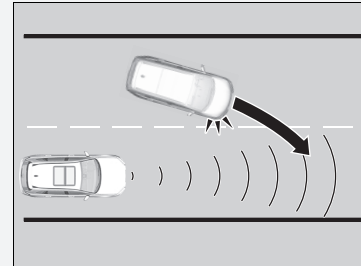

Depress the brake pedal, and keep an appropriate interval from the vehicle ahead.

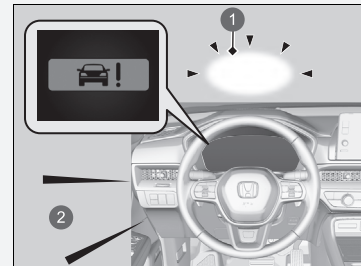

- ① Head-up Warning Lights\*
- ② Audible Alert

\* Not available on all models

Continued

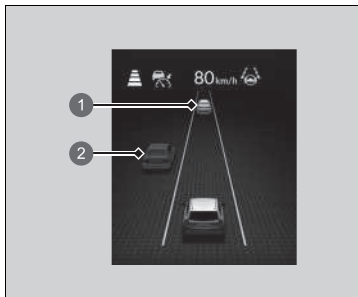

A vehicle icon appears on the gauge.

- ① Control target vehicle: White and outlined in green
- ② Outside of control target vehicle: Grey

When a vehicle whose speed is slower than your set speed comes in or cuts in front of you and is detected by the radar and the camera, your vehicle starts to slow down.

#### ▶▶ When in Operation

Even if the interval between your vehicle and the vehicle detected ahead is short, ACC with Low Speed Follow may start accelerating your vehicle under the following circumstances:

- The vehicle ahead of you is going at almost the same speed as, or faster than, your vehicle.
- A vehicle that cuts in front of you is going faster than your vehicle, gradually increasing the interval between the vehicles.

You can also set the system to beep when a vehicle detected in front of you comes in and goes out of the ACC with Low Speed Follow detecting range.

A vehicle detect beep on and off can be selected.

#### ▶▶ How to Customize the Vehicle Settings

P. 368

#### Limitations

You may need to use the brake to maintain a safe interval when using ACC with Low Speed Follow. Additionally, ACC with Low Speed Follow may not work properly under certain conditions.

#### ▶▶ ACC with Low Speed Follow Conditions and Limitations P. 535

### ■ There is no vehicle ahead

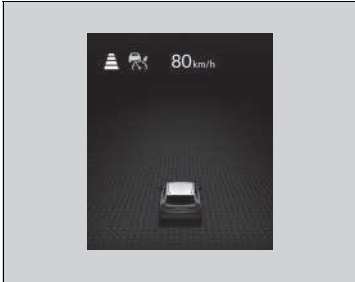

Your vehicle maintains the set speed without having to keep your foot on the brake or accelerator pedal.

If there previously was a vehicle detected ahead that kept your vehicle from travelling at the set speed, ACC with Low Speed Follow accelerates your vehicle to the set speed, and then maintains it.

On steep downhill during ACC with Low Speed Follow, it brakes to inhibit excessive acceleration for maintaining the set speed. However, the vehicle speed may become faster than the set speed.

### ■ When you depress the accelerator pedal

You can temporarily increase the vehicle speed. In this case, there is no audible or visual alert even if a vehicle is in the ACC with Low Speed Follow range. ACC with Low Speed Follow stays on unless you cancel it. Once you release the accelerator pedal, the system resumes an appropriate speed for keeping the following-interval while a vehicle ahead is within the ACC with Low Speed Follow range.

### ⌘ When in Operation

- ACC with Low Speed Follow may temporarily control the interval between your vehicle and the vehicle in adjacent lane or surroundings of your vehicle depending on the road conditions (e.g., curves) or vehicle conditions (e.g., operating the steering wheel or the vehicle location in the lane).

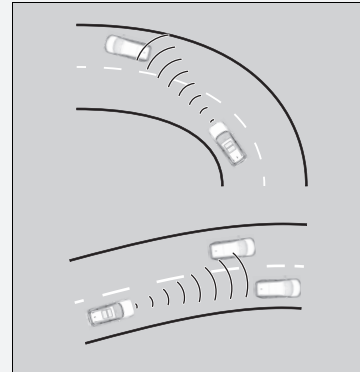

- When the vehicle ahead of you moves away, such as when entering an interchange or rest area, ACC with Low Speed Follow may continue to maintain the set following-interval for a short time.

■ A vehicle detected ahead is within ACC with Low Speed Follow range and slows to a stop



Your vehicle also stops, automatically. The **Stopped** message appears on the gauge. When the vehicle ahead of you starts again, if you press the **RES/+SET/-** switch up or down, or depress the accelerator pedal, ACC with Low Speed Follow operates again within the previously set speed.

1 or (green)

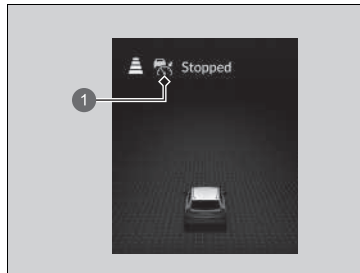

If no vehicle is ahead of you before you resume driving, depress the accelerator pedal and ACC with Low Speed Follow will operate again within the prior set speed.

1 or (green)

## ■ ACC with Low Speed Follow Conditions and Limitations

The system may automatically shut off under certain conditions. Some examples of these conditions are listed below. Other conditions may reduce some of the ACC with Low Speed Follow functions.

📷 **Front Sensor Camera** P. 585

📷 **Radar Sensor** P. 587

### ■ Environmental conditions

- Driving in bad weather (rain, fog, snow, etc.).
- When nearby radio wave emitting devices such as other automotive radar sensors.
- Driving into low sunlight (e.g., at dawn or dusk).
- Reflections on the interior of the windscreen.
- When driving for long distances on a road in a trafficless area such as a desert.

### ■ Roadway conditions

- Driving on a snowy or wet roadway (obscured lane marking, vehicle tracks, reflected lights, road spray, high contrast).

### 📷 ACC with Low Speed Follow Conditions and Limitations

If you need the radar sensor to be repaired, or removed, or the front grille is strongly impacted, turn off the system by pressing the  button and take your vehicle to a dealer.

Have your vehicle checked by a dealer if you find any unusual behaviour of the system (e.g., the warning message appears too frequently).

*Continued*

### ■ Vehicle conditions

- The front of the camera is obstructed by dirt, fog, rain, mud, wet snow, accessories, decals, stickers, film, etc.
- The area around the front grille is obstructed by dirt, rain, mud, wet snow, accessories, decals, stickers, film, etc.
- An abnormal tyre or wheel condition (incorrect sizes, varied sizes or construction, improperly inflated, etc.).
- The camera temperature gets too high.
- The inside of the windscreen is fogged.
- The electric parking brake is applied.
- The front grille is dirty.
- The vehicle is tilted due to a heavy luggage or suspension modifications.
- Tyre chains are installed.
- The vehicle is towing a trailer.

### ■ Detection limitations

- A vehicle suddenly crosses in front of you.
- The interval between your vehicle and the vehicle ahead of you is too short.
- A vehicle cuts in front of you at a slow speed, and it brakes suddenly.
- You accelerate rapidly and approach the vehicle ahead of you at high speed.
- The vehicle ahead of you is a motorcycle, bicycle, mobility scooter, or other small vehicle.
- There are animals in front of your vehicle.

- You drive on a curved or winding or undulating road that makes it difficult for the sensor to properly detect a vehicle in front of you.

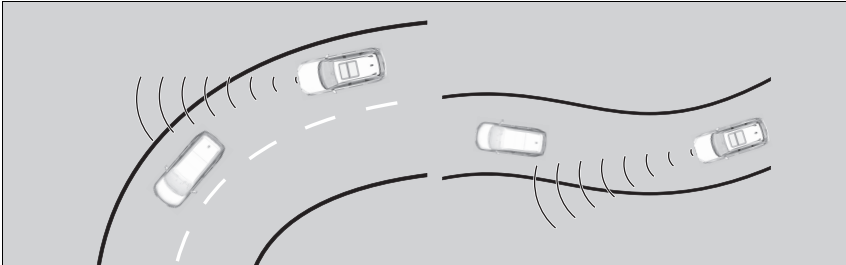

- A vehicle ahead of you stops and the speed difference between your vehicle and the vehicle ahead of you is significantly large.
- An oncoming vehicle suddenly comes in front of you.
- Your vehicle abruptly crosses over in front of an oncoming vehicle.
- Driving through a narrow metal bridge.

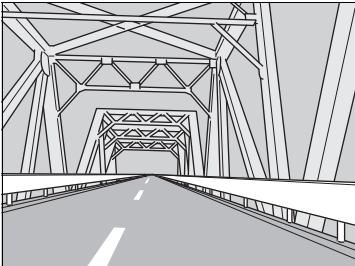

- The vehicle ahead of you brakes suddenly.
- The vehicle ahead of you has a unique shape.

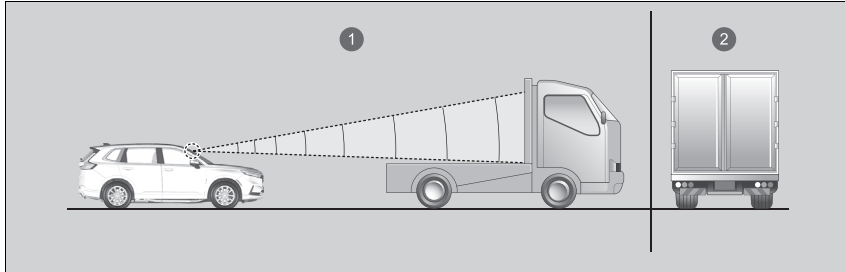

- ① Sensor detects upper section of an empty carrier lorry.
- ② Panel lorry, tanker lorry, etc.

- Your vehicle or the vehicle ahead of you is driving on one edge of the lane.
- When the minimum ground clearance of a vehicle ahead of you is extremely high.

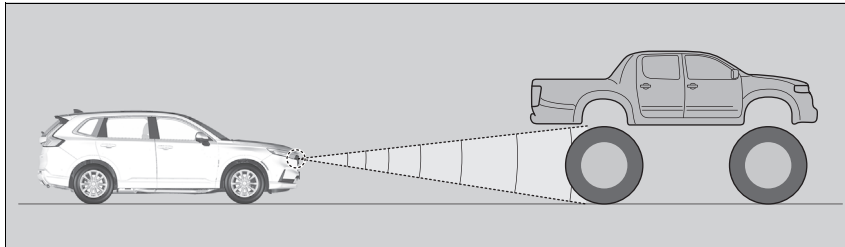

- When the radar and camera cannot correctly identify the shape of the vehicle ahead of you.
- When the vehicle ahead of you blends in with the background, preventing the system from recognising it.

## ■ Cornering Speed Assist

While Adaptive Cruise Control (ACC) with Low Speed Follow is in operation, the system reduces speed to assist the driver with cornering when either the camera detects curves in front of the vehicle, or the driver turns the steering wheel to drive along a curve.

When Cornering Speed Assist slows your vehicle by applying the brakes, your vehicle's brake lights will illuminate.

Cornering Speed Assist may not activate or may not detect lane boundary lines or curves under the following conditions:

### ■ Environmental conditions

- There is little contrast between lane lines and the roadway surface.
- Driving in bad weather (rain, fog, snow, etc.).
- Driving on a snowy or wet roadway.
- Driving into low sunlight (e.g., at dawn or dusk).
- Shadows of adjacent objects (trees, buildings, guard rails, vehicles, etc.) are parallel to white (or yellow) lines.
- Sudden changes between light and dark, such as the entrance or exit of a tunnel or the shadows of trees, buildings, etc.
- Driving at night or in a dark place such as a tunnel (due to low-light conditions, lane lines or the road surface may not be illuminated).
- The distance between your vehicle and the vehicle ahead of you is too short, and lane lines and the road surface are not visible.
- Strong light is reflected onto a vehicle or the roadway.
- When driving for long distances on a road in a trafficless area such as a desert.

## ☒ Cornering Speed Assist

Cornering Speed Assist may not detect all lane markings (white or yellow lines); accuracy will vary based on weather, speed, and lane marker condition. Carefully check your surroundings and operate your vehicle safely.

You can customize system settings from the audio/information screen.

### ➤ How to Customize the Vehicle Settings

P. 368

### ■ Roadway conditions

- Driving on a road with temporary lane markings.
- Faint, multiple, or varied lane markings are visible on the roadway due to road repairs or old lane markings.

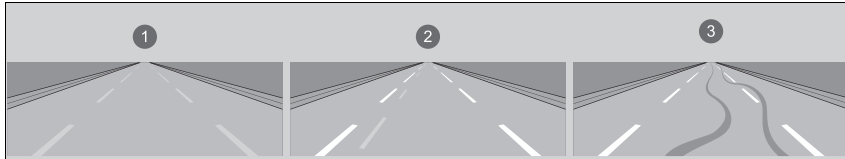

- ① Faded lines                      ② Duplicate lines                      ③ Tyre tracks

- The roadway has merging, split, or crossing lines, such as at an intersection or crosswalk.
- The lane markings are extremely narrow, wide, or changing.

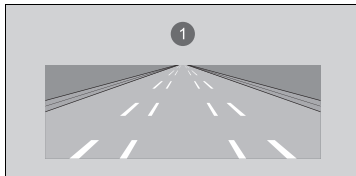

- ① Very wide or narrow traffic lane

- Part of the lane markings are hidden by an object, such as a vehicle.
- The road is hilly or the vehicle is approaching the crest of a hill.
- Your vehicle is strongly shaken on uneven road surfaces.

- When objects on the road (curb, guard rail, pylons, etc.) are recognised as white (or yellow) lines.
- Driving on rough or unpaved roads, or over bumpy surfaces.
- Driving on roads with double lane lines.
- Driving on snowy or slippery roads.
- The pavement is only partially visible due to snow or puddles on the road.
- There is a film of water or puddles on the road surface.
- White (or yellow) lines are not recognised correctly due to road conditions such as curves, twists, or hills.
- Driving on unpaved or rutted roads.
- Passing through a junction.

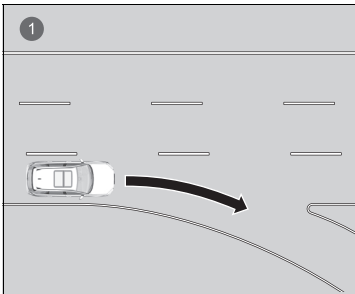

① Lane void of lines at junction

### ■ Vehicle conditions

- When lighting is weak due to dirt covering the headlight lenses, or there is poor visibility in a dark place due to the headlights being improperly adjusted.
- The front of the camera is obstructed by dirt, fog, rain, mud, wet snow, accessories, decals, stickers, film, etc.
- The area around the front grille is obstructed by dirt, rain, mud, wet snow, accessories, decals, stickers, film, etc.
- Driving at night or in a dark place (e.g., a tunnel) with the headlights off.
- There is residue on the windscreen from the windscreen wipers.
- An abnormal tyre or wheel condition (incorrect sizes, varied sizes or construction, improperly inflated, etc.).
- The vehicle is tilted due to a heavy luggage in the luggage area or rear seats.
- The suspension has been modified.
- Tyre chains are installed.
- The vehicle is towing a trailer.

## ■ To Adjust the Vehicle Speed

Increase or decrease the vehicle speed using the **RES/+**/**SET/-** switch on the steering wheel.

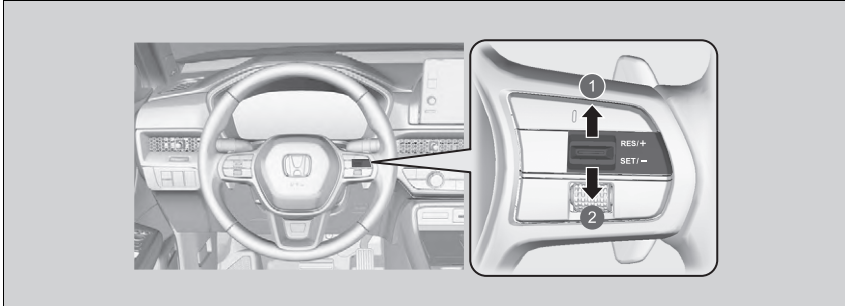

- ① To increase speed
- ② To decrease speed

- Each time you press the **RES/+**/**SET/-** switch up or down, the vehicle speed is increased or decreased by about 1 km/h or 1 mph accordingly.
- If you keep the **RES/+**/**SET/-** switch pressed up or down, the vehicle speed increases or decreases by about 10 km/h or 10 mph accordingly.

## ☒ To Adjust the Vehicle Speed

If a vehicle detected ahead is going at a speed slower than your increased set speed, ACC with Low Speed Follow may not accelerate your vehicle. This is to maintain the set interval between your vehicle and the vehicle ahead.

When you depress the accelerator pedal and then press down and release the **RES/+**/**SET/-** switch, the current speed of the vehicle is set.

## ■ To Set or Change Following-interval

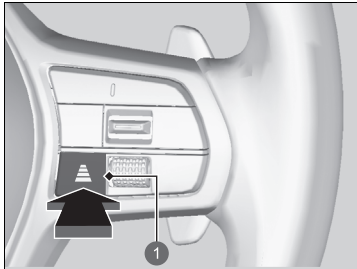





1 Interval Button

Press the Interval button to change the ACC with Low Speed Follow following-interval. Each time you press the button, the following-interval (the interval behind a vehicle detected ahead of you) setting cycles through extra long, long, middle, and short following-intervals.

Determine the most appropriate following-interval setting based on your specific driving conditions. Be sure to adhere to any following-interval requirements set by local regulation.

The higher your vehicle's following-speed is, the longer the short, middle, long, or extra long following-interval becomes. See the following examples for your reference.

Following-interval		When the Set Speed is:	
		80 km/h (50 mph)	104 km/h (65 mph)
Short		25 metres 82 feet 1.1 sec	31 metres 101.7 feet 1.1 sec
Middle		33 metres 108.3 feet 1.5 sec	42 metres 137.8 feet 1.5 sec
Long		47 metres 154.2 feet 2.1 sec	61 metres 200.1 feet 2.1 sec
Extra long		63 metres 206.7 feet 2.9 sec	83.4 metres 273.6 feet 2.9 sec

When your vehicle stops automatically because a vehicle detected ahead of you has stopped, the interval between the two vehicles will vary based on the ACC with Low Speed Follow interval setting.

⚠ To Set or Change Following-interval

The driver must in all circumstances preserve a sufficient braking interval from the vehicle which precedes it and be aware that minimum intervals or times of spacing can be provided by the provisions of the Motorway Code locally applicable and that it is the driver's responsibility to respect those laws.

## ■ To Cancel

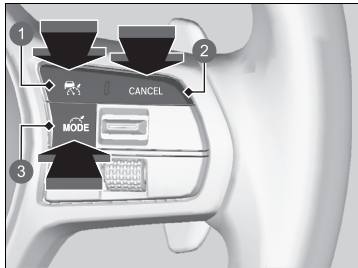

- ① Button
- ② **CANCEL** Button
- ③ Button

To cancel ACC with Low Speed Follow, do any of the following:

- Press the **CANCEL** button.
  - ▶ The or indicator (green) on the gauge changes to the or indicator (white).
- Press the button.
  - ▶ or indicator (green) goes off.
- Press the button.
  - ▶ The or indicator (green) on the gauge changes to the or indicator (white).

## ▶▶ To Cancel

Resuming the prior set speed: After you have cancelled ACC with Low Speed Follow, you can activate the ACC with Low Speed Follow with the prior set speed displayed on the gauge (in grey) by pressing the **RES/+SET/-** switch up even if the vehicle is stopped.

When you turn the ACC with Low Speed Follow off by pressing the **CANCEL** button or depressing the brake pedal, the prior set speed is displayed on the gauge in grey.

When pressing the **RES/+SET/-** switch up, the ACC with Low Speed Follow is activated with displayed speed.

If the or indicator (white) is displayed and you press the **RES/+SET/-** switch up, but no prior set speed (in grey) is displayed, the speed will be set to your vehicle's current speed.



- ① or (white)
- ② Prior Set Speed (grey)

## ■ Automatic cancellation



The beeper sounds and a message appears on the driver information interface when ACC with Low Speed Follow is automatically cancelled. Any of these conditions may cause the ACC with Low Speed Follow to automatically cancel:

- Bad weather (rain, fog, snow, etc.)
- The area around the front grille is obstructed by dirt, rain, mud, wet snow, accessories, decals, stickers, film, etc.
- The vehicle ahead of you cannot be detected.
- An abnormal tyre condition is detected, or the tyres are skidding.
- Driving on a mountainous road for extended periods, or driving off road.
- Abrupt steering wheel movement.
- When the ABS, VSA, CMBS, or Low Speed Braking Control is activated.
- When the ABS or VSA system indicator comes on.
- When the vehicle is stopped on a very steep slope.
- When you manually apply the parking brake.
- When the detected vehicle within the ACC with Low Speed Follow range is too close to your vehicle.
- When accelerating rapidly.
- The camera behind the rearview mirror, or the area around the camera, including the windscreen, gets dirty.
- When the maximum permissible weight is exceeded.
- When passing through an enclosed space, such as tunnel.
- The vehicle has repeatedly applied the brakes to maintain the set speed (for example, you are descending a long slope).
- When the system doesn't detect any driving actions from the driver for a certain amount of time while the LKAS or Traffic Jam Assist is also activated.
- When the parking brake and brake system indicator (amber) comes on.

The ACC with Low Speed Follow automatic cancellation can be also triggered by the following causes. In these cases, the parking brake will be automatically applied.

- The driver's seat belt is unfastened when the vehicle is stationary.
- The vehicle stops for more than 10 minutes.
- The power system is turned off.

### ▶▶ To Cancel

The set speed cannot be set or resumed when ACC with Low Speed Follow has been turned off using the  button. Press the  button to activate the system, then set the desired speed.

## ■ Intelligent Adaptive Cruise Control Function

Provides an early prediction for a cut-in situation. The system detects that a vehicle running in the adjacent slower lane has an intention to cut in front of you and adjusts the speed of your vehicle in advance while ACC with Low Speed Follow is activated.

### ■ How the system works

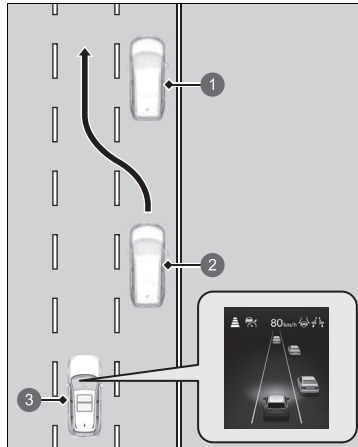

Left-hand drive type is shown.

- 1 Slow Vehicle
- 2 Cut-in Vehicle
- 3 Your Vehicle

The radar sensor behind the Honda emblem on the front grille detects vehicles ahead of you including those in the adjacent lane, and the camera behind the rearview mirror detects the lane markings.

This system improves ACC with Low Speed Follow's following/tracking property; it adjusts your vehicle speed in advance predicting a situation that a vehicle running in the adjacent slower lane catches up with a slower vehicle ahead of it and changes the lane to cut in front of you early.

When such a cut-in situation is predicted, your vehicle speed decreases a little. When detected, your vehicle speed decreases according to the vehicle cutting in front of you.

As the speed is adjusted by the system, the cut in vehicle icon appears on the gauge to indicate that the system is activated.

## ■ How the system activates

When a vehicle cuts in front of you is going faster than the vehicle ahead of it, and your vehicle is going faster than the cut-in vehicle (i.e., when you need to slow down), ACC with Low Speed Follow predicts the cutting-in and adjust your vehicle speed.

The system activates when all the following conditions are met:

- When ACC with Low Speed Follow is activated.
- When you are driving on a multi-lane road.
- When your vehicle speed is between about 80 km/h (50 mph) and about 180 km/h (112 mph).
- The vehicle is on a straight or slightly curved road.
- The turn signals are off.
- The brake pedal is not depressed.
- When a vehicle cuts in from a slower lane.

## ■ Intelligent adaptive cruise control on and off

You can turn the system on and off using the audio/information screen.

📄 **How to Customize the Vehicle Settings** P. 368

### 📄 Intelligent Adaptive Cruise Control Function

When traffic changes from right hand side to left hand side, driving on a road where there is oncoming traffic for some distance automatically switches the lane to be detected from right to left.

Intelligent adaptive cruise control may not activate under the following conditions:

- When the speed difference between the cut-in vehicle and the vehicle ahead of it in the adjacent lane\*<sup>1</sup> is small
- When the speed difference between the cut-in vehicle and your vehicle is small (i.e., when speed adjustment is not required)
- When a vehicle simply cuts in front of your vehicle with no vehicle ahead in the adjacent lane\*<sup>1</sup>
- When a vehicle cuts in from a faster lane\*<sup>1</sup>

\*1: Refers to a right hand lane for right hand traffic, left hand lane for left hand traffic.

## Lane Keeping Assist System (LKAS)

Provides steering input to help to keep the vehicle in the middle of a detected lane and provides tactile, audible and visual alerts if the vehicle is detected drifting out of its lane.

### ■ Steering input assist

The system applies torque to the steering to keep the vehicle between the left and right lane lines. The applied torque becomes stronger as the vehicle gets closer to either of the lane lines.

### ■ Tactile, audible and visual alerts

Rapid vibrations on the steering wheel, audible and a warning display alert you that the vehicle is drifting out of a detected lane.

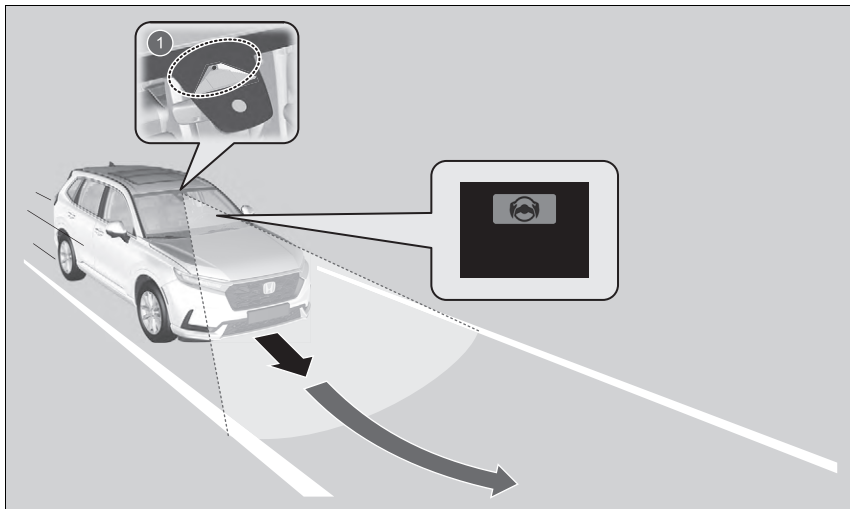

1 Front Sensor Camera: Monitors the lane lines

### ▶ Lane Keeping Assist System (LKAS)

#### Important Safety Reminders

The LKAS is for your convenience only. It is not an autonomous driving system and always requires driver attention and control. The system does not work if you take your hands off the steering wheel or fail to steer the vehicle.

The LKAS is convenient when it is used on motorways or a dual carriage way.

Do not place objects on the instrument panel. Objects may reflect on the windscreen and prevent correct detection of the traffic lanes.

The LKAS may not detect all lane markings or lane departures; accuracy will vary based on weather, speed, and lane marker condition. It is always your responsibility to safely operate the vehicle and avoid collisions.

The LKAS may not work properly or may work improperly under the certain conditions:

▶ **LKAS Conditions and Limitations** P. 557

You can read about handling information for the camera equipped with this system.

▶ **Front Sensor Camera** P. 585

In some situations, if you make a lane change without operating the turn signals, the LKAS alerts activate, and torque is applied to the steering.

## ■ Lane Keep Support Function

Provides assistance to keep the vehicle in the centre of the lane. When the vehicle nears a white or yellow line, steering force of the electric power steering will become stronger.

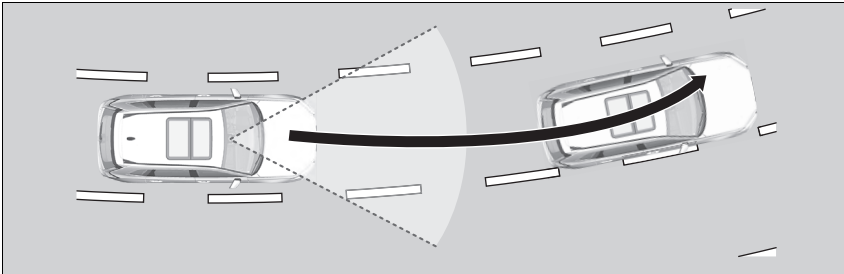

### ☒ Lane Keeping Assist System (LKAS)

When it fails to detect lanes, the system will temporarily be cancelled. When a lane is detected, the system will recover automatically.

The LKAS may not function as designed while driving in frequent stop and go traffic, or on roads with sharp curves.

For directions on the proper handling of the radar sensor, refer to the following page.

➡ **Radar Sensor** P. 587

LKAS is not activated for about 15 seconds after the power system is turned on.

## ■ Lane Departure Warning Function

When the vehicle enters the warning area, the LKAS alerts you with slight steering wheel vibration, and audible as well as a warning display.

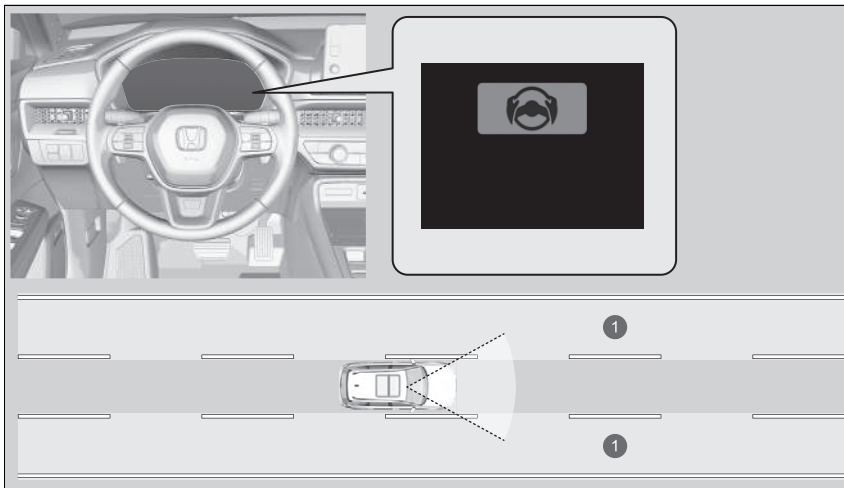

① Warning Area

## ■ When the System can be Used

The system can be used when the following conditions are met.

- The lane in which you are driving has detectable lane markers on both sides, and your vehicle is in the centre of the lane.
- You are driving on a straight or slightly curved road.
- The turn signals are off.
- The brake pedal is not suddenly depressed.
- The vehicle is travelling between about 72 and 180 km/h (45 and 112 mph).

## ■ How to activate the system

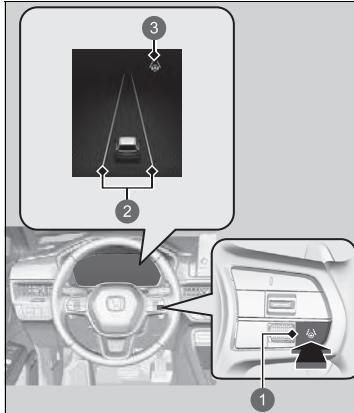

- ① LKAS Button
- ② White lines
- ③ LKAS indicator (white)

### 1. Press the LKAS button.

- ▶ LKAS indicator (white) appears on the gauge.  
The system is standby.
- ▶ If traffic lane lines are detected, white lines appear on the gauge.

## ☒ When the System can be Used

If the vehicle drifts towards either left or right lane line due to the system applying torque, turn off the LKAS and have your vehicle checked by a dealer.

Follow the points below to properly activate the system:

- Always keep the windscreen around the camera clean.
- When cleaning the windscreen, be careful not to apply windscreen cleanser to the camera lens.
- Do not touch the camera lens.
- Do not attach a sticker to the area around the camera.

If LKAS button is pressed when the system can be used, LKAS is on without standby.

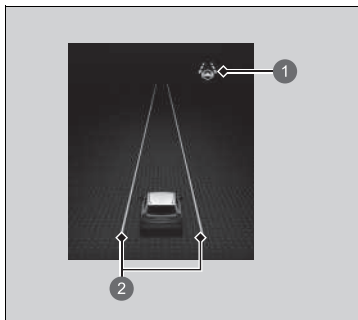

- ① LKAS indicator (green)
- ② Green lines

2. Keep your vehicle near the centre of the lane while driving.
  - ▶ The LKAS indicator changes from white to green, and white lines change to green once the system starts operating after detecting the left and right lane markings.

## ■ To Cancel



① LKAS Button

Press the LKAS button.

The LKAS is turned off every time you turn the power system off, even if you turned it on the last time you drove the vehicle.

■ **The LKAS may be automatically suspended when:**

When the LKAS is suspended under the following circumstances, green lines on the gauge change to white lines or disappear, and the beeper sounds (if activated).

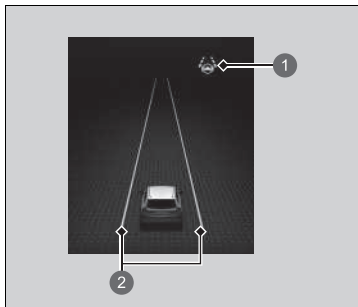

- ① LKAS indicator (white)
- ② White lines

- The system fails to detect lane lines.
- The steering wheel is turned quickly.
- You are not operating the steering wheel.
- Driving through a sharp curve.
- Driving at a speed exceeding the operating speed.
- Your vehicle is driving to the right or the left of the lane.
- The brake pedal is suddenly depressed.
- The ABS, VSA or CMBS is activated.

Once these conditions no longer exist, the LKAS automatically resumes.

■ **The LKAS may be automatically cancelled when:**

In the following cases, traffic lane lines may disappear on the gauge, the beeper may sound, and the LKAS may be automatically cancelled:

- The camera temperature gets extremely high.
- The camera behind the rearview mirror, or the area around the camera, including the windscreen, gets dirty.

▶▶ The LKAS may be automatically suspended when:

You can change the setting for the LKAS. LKAS suspended beep on and off can be selected.

- ▶ **How to Customize the Vehicle Settings**  
P. 368

## LKAS Conditions and Limitations

The system may not detect lane markings (in white or yellow), and LKAS may not function properly under certain conditions, including the following:

### ■ Environmental conditions

- There is little contrast between lane lines and the roadway surface.
- Driving in bad weather (rain, fog, snow, etc.).
- Driving on a snowy or wet roadway.
- Driving into low sunlight (e.g., at dawn or dusk).
- Shadows of adjacent objects (trees, buildings, guard rails, vehicles, etc.) are parallel to white (or yellow) lines.
- Sudden changes between light and dark, such as the entrance or exit of a tunnel or the shadows of trees, buildings, etc.
- Driving at night or in a dark place such as a tunnel (due to low-light conditions, lane lines or the road surface may not be illuminated).
- The distance between your vehicle and the vehicle ahead of you is too short, and lane lines and the road surface are not visible.
- Strong light is reflected onto the roadway.
- Reflections on the interior of the windshield.

### ⓘ LKAS Conditions and Limitations

Under the following circumstances, some Honda Sensing features may continue to operate without warning that your hands are off the steering wheel, even when there is no steering input.

- An object or part of your body is touching or is too close to the steering wheel.

*Continued*

### ■ Roadway conditions

- Driving on a road with temporary lane markings.
- Faint, multiple, or varied lane markings are visible on the roadway due to road repairs or deteriorated lane markings.

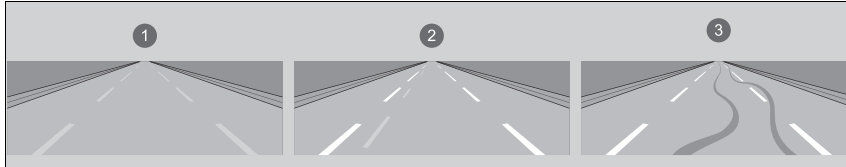

- ① Faded lines                      ② Duplicate lines                      ③ Tyre tracks

- The roadway has merging, split, or crossing lines, such as at an intersection or crosswalk.
- The lane markings are extremely narrow, wide, or changing.

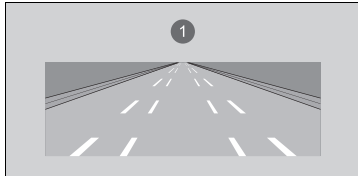

- ① Very wide or narrow traffic lane

- Part of the lane markings are hidden by an object, such as a vehicle.
- The road is hilly or the vehicle is approaching the crest of a hill.
- Your vehicle is strongly shaken on uneven road surfaces.

- When objects on the road (curb, guard rail, pylons, etc.) are recognised as white (or yellow) lines.
- Driving on rough or unpaved roads, or over bumpy surfaces.
- Driving on roads with double lane lines.
- Driving on snowy or slippery roads.
- The pavement is only partially visible due to snow or puddles on the road.
- There is a film of water or puddles on the road surface.
- White (or yellow) lines are not recognised correctly due to road conditions such as curves, twists, or hills.
- Driving on unpaved or rutted roads.
- Passing through a junction.

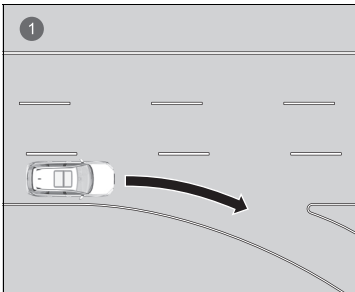

① Lane void of lines at junction

### ■ Vehicle conditions

- When lighting is weak due to dirt covering the headlight lenses, or there is poor visibility in a dark place due to the headlights being improperly adjusted.
- The front of the camera is obstructed by dirt, fog, rain, mud, wet snow, accessories, decals, stickers, film, etc.
- Driving at night or in a dark place (e.g., a tunnel) with the headlights off.
- There is residue on the windscreen from the windscreen wipers.
- An abnormal tyre or wheel condition (incorrect sizes, varied sizes or construction, improperly inflated, etc.).
- The vehicle is tilted due to a heavy luggage in the luggage area or rear seats.
- The suspension has been modified.
- Tyre chains are installed.
- The vehicle is towing a trailer.
- The inside of the windscreen is fogged.

### ■ Examples of other limitations on system operation

- You are wearing gloves.
- There is a protective cover on the steering wheel.

## Traffic Jam Assist

The Traffic Jam Assist system uses a camera mounted to the upper portion of the windshield to detect and monitor left and right white (or yellow) traffic lane lines. Based on inputs from the camera, the system can apply steering torque to keep your vehicle in the centre of the detected lane.

### Traffic Jam Assist Function

When you are in heavy traffic and Lane Keeping Assist System (LKAS) is active, the Traffic Jam Assist system, upon detecting the traffic lane lines, will apply steering torque to help keep your vehicle in the centre of the lane.

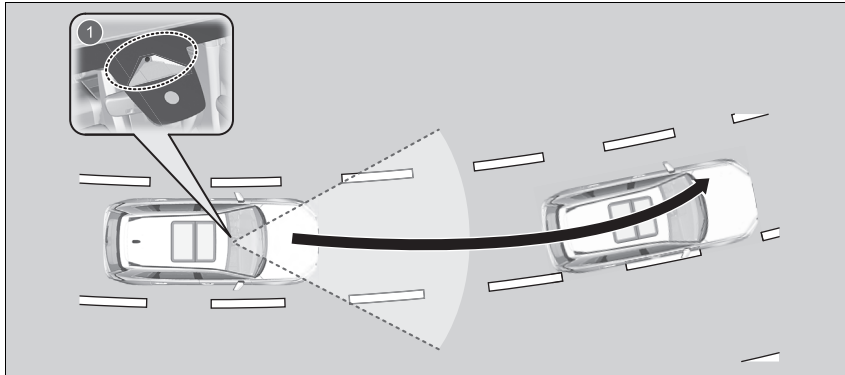

- ① Front Sensor Camera  
Detects left and right white (or yellow) traffic lane lines

In some situations, if you make a lane change without operating the turn signals, the Traffic Jam Assist alerts activate, and torque is applied to the steering.

### Traffic Jam Assist

#### Important Safety Reminders

Traffic Jam Assist is for your convenience only. It is not an autonomous driving system and always requires driver attention and control. The system does not work if you take your hands off the steering wheel or fail to steer the vehicle.

Traffic Jam Assist is convenient when it is used on motorways or a dual carriage way.

You can read about handling information for the camera equipped with this system.

▶ **Front Sensor Camera** P. 585

The Traffic Jam Assist may not detect all lane markings or lane departures; accuracy will vary based on weather, speed, and lane marker condition. It is always your responsibility to safely operate the vehicle and avoid collisions.

Traffic Jam Assist may not work properly under certain conditions:

▶ **Traffic Jam Assist Conditions and Limitations** P. 566

For directions on the proper handling of the radar sensor, refer to the following page.

▶ **Radar Sensor** P. 587

When the driver takes full control of the steering, the steering assist function is temporarily cancelled.

The torque applied to the steering may not be noticeable when the driver has full control of the steering, or when the surface of the road is rough or uneven.

### ■ Lane Departure Warning Function

When the vehicle enters the warning area, Traffic Jam Assist alerts you with slight steering wheel vibration or an audible alert as well as a warning display.

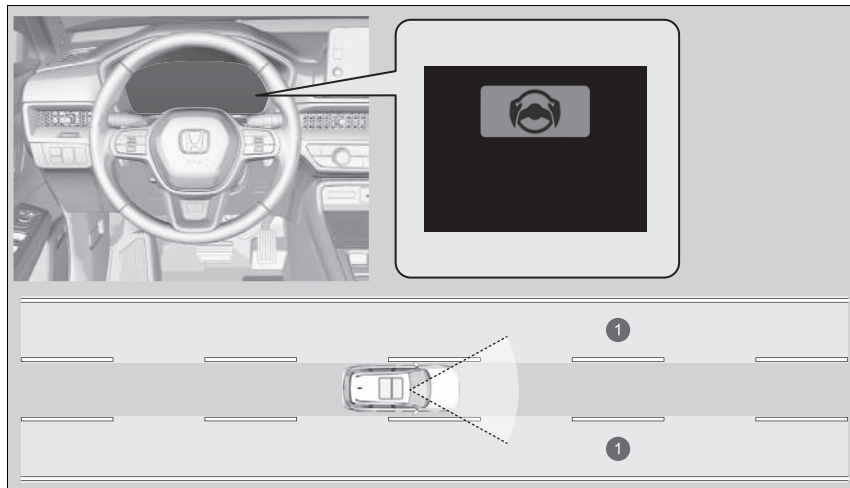

① Warning Area

### ▶▶ Traffic Jam Assist

Traffic Jam Assist is not activated for about 15 seconds after the power system is turned on.

## ■ When the System can be Used

Traffic Jam Assist is activated when all of the following conditions exist:

- LKAS is activated.
- The lane in which you are driving has detectable lane markers on both sides, and your vehicle is in the centre of the lane.
- The vehicle is travelling between about 0 and 72 km/h (0 and 45 mph).
- You are driving on a straight or slightly curved road.
- The driver is gripping the steering wheel.
- The shift position is in **D** or **B**.
- The turn signals are off.

Do not use Traffic Jam Assist in any of the following situations:

- You are travelling on a road with sharp curves.
  - ▶ The system may not allow your vehicle to respond in a manner best suited for the road conditions.
- You are entering a toll booth, interchange, service area, or parking area.
- You are driving in adverse weather (rain, fog, snow, etc.).
- The surface of the road is slippery; for example, it is icy or covered with snow.
  - ▶ The tyres may slip, causing you to lose control of the vehicle.

## ☒ When the System can be Used

Refer to the following page for proper handling of the Lane Keeping Assist System (LKAS):

☒ **Lane Keeping Assist System (LKAS)** P. 550

Refer to the following page for steering buttons and displays:

☒ **Operation Switches for the Adaptive Cruise Control (ACC) with Low Speed Follow/Lane Keeping Assist System (LKAS)/Traffic Jam Assist/Active Lane Change Assist** P. 480

☒ **Gauge Content** P. 482

### ■ How to activate the system

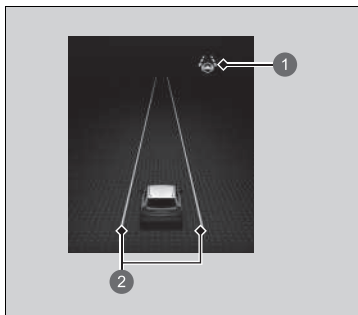

- ① LKAS indicator (green)
- ② Green lines

Keep your vehicle near the centre of the lane while driving.

- ▶ The LKAS indicator changes from white to green, and white lines change to green once the system starts operating after detecting the left and right lane markings.

### ☒ How to activate the system

If your vehicle veers too far to the right or the left of the white (or yellow) traffic lane lines while Traffic Jam Assist is active, deactivate Traffic Jam Assist and have your vehicle checked by a dealer.

In some cases the system cannot properly detect the traffic lane lines and, as a result, will not provide steering assistance.

#### ☒ Traffic Jam Assist Conditions and Limitations P. 566

If the driver is not operating the steering wheel, the warning below will appear.

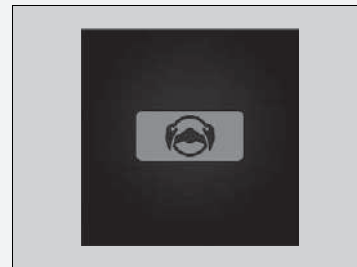

If the driver does not operate the steering wheel after the warning above has repeatedly appeared, a warning buzzer will sound and Traffic Jam Assist will be cancelled.

## ■ To Cancel

Press the LKAS button to cancel Traffic Jam Assist.

### ■ Traffic Jam Assist may be automatically suspended when:

- The system fails to detect lane lines.
- The steering wheel is turned sharply.
- You are not operating the steering wheel.
- You are driving through a sharp curve.
- The ABS, VSA, CMBS, or Low Speed Braking Control is activated.
- Your vehicle is driving to the right or the left of the lane.
- The brake pedal is suddenly depressed.

Once these conditions no longer exist, Traffic Jam Assist automatically resumes.

### ■ Traffic Jam Assist may be automatically cancelled when:

- The temperature of the camera is too high.
- The camera behind the rearview mirror, or the area around the camera, including the windscreen, is dirty.

Upon cancellation, the lane lines will disappear from the screen and the beeper may sound.

### ☒ Traffic Jam Assist may be automatically suspended when:

You can change the setting for the Traffic Jam Assist suspended beep on and off can be changed when you select the **Lane keep assist beep** on the audio/information screen.

➤ **Customized Features** P. 360

*Continued*

## ■ Traffic Jam Assist Conditions and Limitations

The system may not detect lane markings (in white or yellow), and Traffic Jam Assist may not function properly under certain conditions, including the following:

### ■ Environmental conditions

- There is little contrast between lane lines and the roadway surface.
- Driving in bad weather (rain, fog, snow, etc.).
- Driving on a snowy or wet roadway.
- Driving into low sunlight (e.g., at dawn or dusk).
- Shadows of adjacent objects (trees, buildings, guard rails, vehicles, etc.) are parallel to white (or yellow) lines.
- Sudden changes between light and dark, such as the entrance or exit of a tunnel or the shadows of trees, buildings, etc.
- Driving at night or in a dark place such as a tunnel (due to low-light conditions, lane lines or the road surface may not be illuminated).
- When the lane lines or road surface are not visible, such as when the distance to the vehicle in front of you is extremely short or when at a junction.
- Strong light is reflected onto the roadway.
- Reflections on the interior of the windscreen.
- Water is being splashed or snow is being flung by the preceding vehicle (including motorcycles).
- When nearby radio wave emitting devices such as other automotive radar sensors.
- When driving for long distances on a road in a trafficless area such as a desert.

### ▶▶ Traffic Jam Assist Conditions and Limitations

Under the following circumstances, some Honda Sensing features may continue to operate without warning that your hands are off the steering wheel, even when there is no steering input.

- An object or part of your body is touching or is too close to the steering wheel.

## ■ Roadway conditions

- Driving on a road with temporary lane markings.
- Faint, multiple, or varied lane markings are visible on the roadway due to road repairs or deteriorated lane markings.

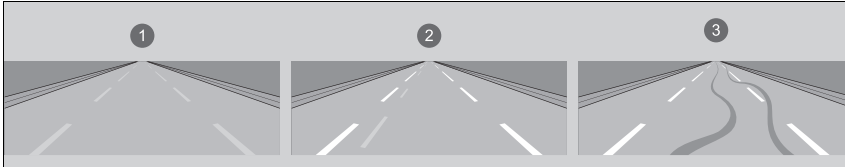

- ① Faded lines                      ② Duplicate lines                      ③ Tyre tracks

- The roadway has merging, split, or crossing lines, such as at an intersection or crosswalk.
- The lane markings are extremely narrow, wide, or changing.

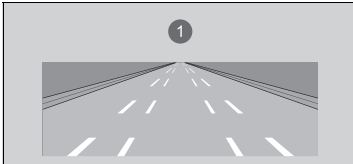

- ① Very wide or narrow traffic lane

- Part of the lane markings are hidden by an object, such as a vehicle.
- The road is hilly or the vehicle is approaching the crest of a hill.
- Your vehicle is strongly shaken on uneven road surfaces.

- When objects on the road (curb, guard rail, pylons, etc.) are recognised as white (or yellow) lines.
- Driving on rough or unpaved roads, or over bumpy surfaces.
- Driving on roads with double lane lines.
- Driving on snowy or slippery roads.
- The pavement is only partially visible due to snow or puddles on the road.
- There is a film of water or puddles on the road surface.
- White (or yellow) lines are not recognised correctly due to road conditions such as curves, twists, or hills.
- Driving on unpaved or rutted roads.
- Passing through a junction.

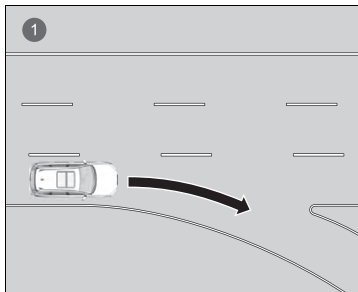

① Lane void of lines at junction

**■ Vehicle conditions**

- When lighting is weak due to dirt covering the headlight lenses, or there is poor visibility in a dark place due to the headlights being improperly adjusted.
- The front of the camera is obstructed by dirt, fog, rain, mud, wet snow, accessories, decals, stickers, film, etc.
- Driving at night or in a dark place (e.g., a tunnel) with the headlights off.
- There is residue on the windscreen from the windscreen wipers.
- An abnormal tyre or wheel condition (incorrect sizes, varied sizes or construction, improperly inflated, etc.).
- The vehicle is tilted due to a heavy luggage in the luggage area or rear seats.
- The suspension has been modified.
- Tyre chains are installed.
- The vehicle is towing a trailer.
- The inside of the windscreen is fogged.

**■ Examples of other limitations on system operation**

- You are wearing gloves.
- There is a protective cover on the steering wheel.

## Active Lane Change Assist

Assists with steering when you operate the turn signal lever to change lanes on motorways.

### How the System Works

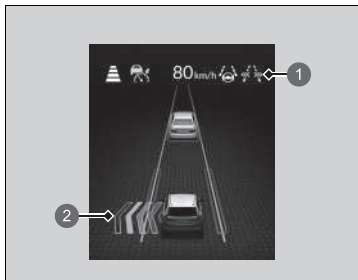

- 1 Active Lane Change Assist indicator (green)
- 2 Lane Change indicator

When Active Lane Change Assist activates, the Active Lane Change Assist indicator (green) and lane change indicator light up on the gauge, and the system assists with steering for the lane change. After changing lanes, the turn signal goes off, and steering assistance stops. When the driver takes direct control of steering, the steering assist function is temporarily cancelled.

### Active Lane Change Assist

#### **WARNING**

Active Lane Change Assist is for your convenience only. It is not an autonomous driving system and always requires driver attention and control.

Overreliance on the system may result in a collision with serious injury or death.

Carefully check your surroundings and operate your vehicle safely. Use Active Lane Change Assist only when driving on motorways.

For directions on the proper handling of the radar sensor, refer to the following page.

▶ **Radar Sensor** P. 587

You can read about handling information for the camera equipped with this system.

▶ **Front Sensor Camera** P. 585

Active Lane Change Assist is not activated for about 15 seconds after the power system is turned on.

## ■ When the System can be Used

Active Lane Change Assist operates under the following conditions.

- Lane Keeping Assist System (LKAS) and Adaptive Cruise Control (ACC) with Low Speed Follow are active.
- You are driving on motorways separated by a median strip into two or more lanes on one side.
- The driver is gripping the steering wheel.
- Your vehicle is moving at around 80 km/h (50 mph) or higher.
- You are entering a lane with no vehicles behind or in front of you.
- The boundary of the lane you are changing to is marked with dashed lines.
- You are driving on a straight or slightly curved road.

## ■ How to operate the system

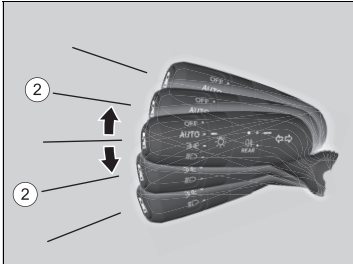

Always make sure to visually confirm the safety of a lane change before changing lanes, and maintain a safe distance between your vehicle and vehicles around you.

When the Active Lane Change Assist indicator (white) is lit up, hold the turn signal lever in the ② position until the beeper sounds.

- ▶ The Active Lane Change Assist indicator (green) comes on, and the system activates.
- ▶ If the beeper sounds three times, the system does not activate.

## ☒ When the System can be Used

Refer to the following pages for directions on the proper handling of ACC with Low Speed Follow:

- ▶ **Adaptive Cruise Control (ACC) with Low Speed Follow** P. 526

Refer to the following pages for directions on the proper handling of the LKAS:

- ▶ **Lane Keeping Assist System (LKAS)** P. 550

When the Drive Mode is changed to **TOW** mode, Active Lane Change Assist will not work.

- ▶ **Drive Mode Switch** P. 445

## ☒ How to operate the system

Active Lane Change Assist will deactivate if you are approached by a vehicle ahead of or behind your vehicle.

Active Lane Change Assist may activate when a vehicle approaches you from the left or right.

The Active Lane Change Assist indicator may not come on under certain conditions, such as when the system does not detect a vehicle far behind you after you start driving, etc.

## ■ To Cancel

By performing the following action during a lane change but while you are still within the same lane in which the operation was started, Active Lane Change Assist will deactivate:

- One-touch turn signal is used
- The lane change is then cancelled.

## ■ Active Lane Change Assist Conditions and Limitations

The system may not operate correctly under the following conditions:

### ■ Environmental conditions

- There is little contrast between lane lines and the roadway surface.
- Driving in bad weather (rain, fog, snow, etc.).
- Driving on a snowy or wet roadway.
- Driving into low sunlight (e.g., at dawn or dusk).
- Shadows of adjacent objects (trees, buildings, guard rails, vehicles, etc.) are parallel to white (or yellow) lines.
- Sudden changes between light and dark, such as the entrance or exit of a tunnel or the shadows of trees, buildings, etc.
- Driving at night or in a dark place such as a tunnel (due to low-light conditions, lane lines or the road surface may not be illuminated).
- When the lane lines or road surface are not visible, such as when the distance to the vehicle in front of you is extremely short.
- Strong light is reflected onto the roadway.
- Water is being splashed or snow is being flung by the preceding vehicle.
- When nearby radio wave emitting devices such as other automotive radar sensors.
- Reflections on the interior of the windshield.
- The system picks up signal interference such as other radar sensors from another vehicle or strong radio wave transmitted from a facility nearby.
- When driving for long distances on a road in a trafficless area such as a desert.

## ▶▶ To Cancel

Active Lane Change Assist will deactivate in the following situations:

- You are making a sharp turn while driving.
- The brake pedal is depressed while the vehicle is moving forward.
- The **CANCEL** button is pressed.
- The  button is pressed.
- The LKAS button is pressed.
- The turn signal lever is pushed up or pressed down until it is held in place.
- The hazard warning button is pressed.

Turn the system off when towing a trailer.

The system may not work properly for the following reasons:

- The added mass tilts the vehicle and changes the radar coverage.
- The radar sensor detects the trailer itself, causing radar coverage to be changed.

## ▶▶ Active Lane Change Assist Conditions and Limitations

Under the following circumstances, some Honda Sensing features may continue to operate without warning that your hands are off the steering wheel, even when there is no steering input.

- An object or part of your body is touching or is too close to the steering wheel.

## ■ Roadway conditions

- Driving on a road with temporary lane markings.
- Faint, multiple, or varied lane markings are visible on the roadway due to road repairs or old lane markings.
- The roadway has merging, split, or crossing lines, such as at an intersection or crosswalk.
- The lane markings are extremely narrow, wide, or changing.
- Part of the lane markings are hidden by an object, such as a vehicle.
- The road is hilly or the vehicle is approaching the crest of a hill.
- Your vehicle is strongly shaken on uneven road surfaces.
- When objects on the road (curb, guard rail, pylons, etc.) are recognised as white (or yellow) lines.
- Driving on rough or unpaved roads, or over bumpy surfaces.
- Driving on roads with double lane lines.
- Driving on snowy or slippery roads.
- The pavement is only partially visible due to snow or puddles on the road.
- There is a film of water or puddles on the road surface.
- White (or yellow) lines are not recognised correctly due to road conditions such as curves, twists, or hills.
- Driving on unpaved or rutted roads.
- Passing through a junction.
- There are objects around your vehicle that reflect radio waves strongly, such as when driving through a tunnel or a narrow metal bridge.
- Objects (guard rails, poles, trees, parked cars, buildings, walls, etc.) are detected.

■ **Vehicle conditions**

- When lighting is weak due to dirt covering the headlight lenses, or there is poor visibility in a dark place due to the headlights being improperly adjusted.
- The front of the camera is obstructed by dirt, fog, rain, mud, wet snow, accessories, decals, stickers, film, etc.
- The area around the front grille, front bumper or rear bumper is obstructed by dirt, rain, mud, wet snow, accessories, decals, stickers, film, etc.
- Driving at night or in a dark place (e.g., a tunnel) with the headlights off.
- There is residue on the windscreen from the windscreen wipers.
- An abnormal tyre or wheel condition (incorrect sizes, varied sizes or construction, improperly inflated, etc.).
- The vehicle is tilted due to heavy luggage in the luggage area or rear seats.
- The suspension has been modified.
- Tyre chains are installed.
- The camera temperature gets too high.
- The inside of the windscreen is fogged.
- Large luggage on the roof is touching the upper part of the windscreen.
- Operation of the vehicle is unstable due to a slippery road, etc.
- Your vehicle is strongly shaken on uneven road surfaces.
- The vehicle is towing a trailer.

**■ Other conditions**

- You are wearing gloves.
- There is a protective cover on the steering wheel.
- The vehicle cannot determine its position due to luggage placed on the roof.
- New road information is not reflected on the navigation map.
- A new road has been built.
- The speed limit has changed.
- The vehicle path that the sensor detected and the actual vehicle path are different.
- There are adjacent roads with speed limits different from the one you are driving on.
- When driving in a place with poor GNSS reception, such as in tunnels or around skyscrapers.
- When the vehicle ahead of you is a small motorcycle, motorcycle with a sidecar, wheelchair, or other specially shaped vehicle.
- When the radar and camera cannot correctly identify the shape of the vehicle ahead of you.
- When the vehicle ahead of you blends in with the background, preventing the system from recognising it.
- When a road sign that looks similar to a non-highway sign is recognised.

## Traffic Sign Recognition System

Reminds you of road sign information, such as the current speed limit and that overtaking is prohibited, and notifies you if your vehicle is exceeding the speed limit.

### ■ How the System Works

The system displays signs recognized as designated for your vehicle using information captured by the camera located behind the rear view mirror from traffic signs and data from the navigation system while driving. The sign icon is usually displayed before passing the sign, and continues to be displayed until another sign is recognized.

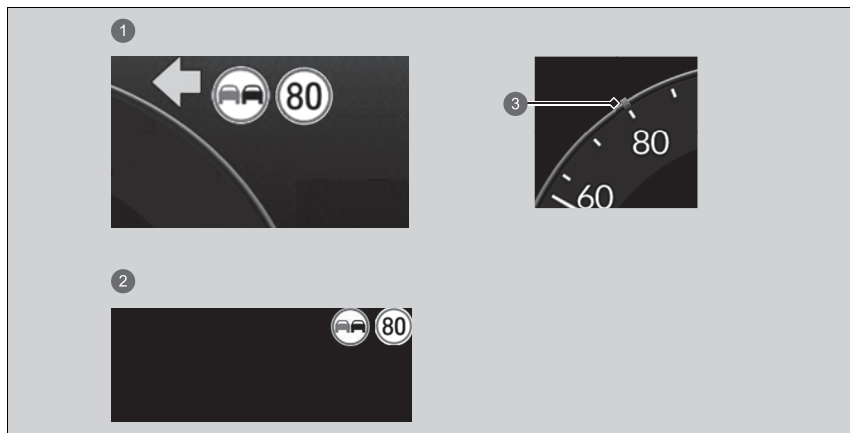

- ① Gauge
- ② Head-up Display\*
- ③ Speed Limit Sign

### ▶▶ Traffic Sign Recognition System

In order to maintain system functionality, it is necessary to keep speed limit information on the Navigation System up to date. Update Navigation System map information regularly.

▶▶ **Refer to the Navigation System Manual**

The system is designed to detect signs that follow the Vienna Convention standards. Not all signs may be displayed, but any signs posted on roadsides should not be ignored. The system does not work on the designated traffic signs of all the countries you travel, nor in all situations.

Do not rely too much on the system. Always drive at speeds appropriate for the road conditions.

Never apply a film or attach any objects to the windshield that could obstruct the camera's field of vision and cause the system to operate abnormally. Scratches, nicks, and other damage to the windshield within the camera's field of vision can cause the system to operate abnormally. If this occurs, we recommend that you replace the windshield with a genuine Honda replacement windshield. Making even minor repairs within the camera's field of vision or installing an aftermarket replacement windshield may also cause the system to operate abnormally. After replacing the windshield, have a dealer recalibrate the camera. Proper calibration of the camera is necessary for the system to operate properly.

You can read about handling information for the camera equipped with this system.

▶▶ **Front Sensor Camera** P. 585

You can turn the Traffic Sign Recognition System on and off. If **None** is selected,  (grey) will appear.

▶▶ **How to Customize the Vehicle Settings**

P. 368

The sign icon also may switch to another one, or disappear when:

- The end of speed limit or other designated limit is detected.
- Your vehicle enters/exits a road with a different speed limit.
- You make a turn with a turn signal at an intersection.

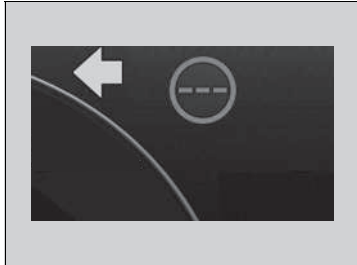

If the system does not detect any traffic signs while you are driving,  (white) may appear.

#### Traffic Sign Recognition System

To help reduce the likelihood that high interior temperatures will cause the camera's sensing system to shut off, find a shady area or face the front of the vehicle away from the sun when parking. If you use a reflective sun shade, do not allow it to cover the camera housing. Covering the camera can concentrate heat on it.

The system's ability to accurately notify the driver of the speed limit is dependent on certain conditions such as the units displayed on the traffic sign as well as the speed and direction of travel of the vehicle. In some cases, the system may display false warnings or other inaccurate information.

#### **Traffic Sign Recognition System Conditions and Limitations** P. 579

You can change the settings for the notification sound that plays when the detected speed limit changes.

#### **How to Customize the Vehicle Settings** P. 368

If your vehicle exceeds the detected speed limit, an icon representing the speed limit sign for the current area will blink in the display, and the beeper will sound if you continue to exceed the detected speed limit.

However, the beeper will not sound if your vehicle is slowing down.

#### **How to Customize the Vehicle Settings** P. 368

#### ▶▶ Traffic Sign Recognition System

The unit for speed limits (km/h or mph) varies from country to country. Just after entering a country whose unit differs to the one of the country from which you came, Traffic Sign Recognition System may not work correctly.

▶ **Speed/Distance Units** P. 175

▶ **How to Customize the Vehicle Settings**

P. 368

Traffic Sign Recognition System is not activated for about 15 seconds after the power system is turned on.

## ■ Traffic Sign Recognition System Conditions and Limitations

The Traffic Sign Recognition system may incorrectly recognise, be slow to identify, or fail to recognise the traffic sign in the following cases.

### ■ Environmental conditions

- Driving into low sunlight (e.g., at dawn or dusk).
- Strong light is reflected onto the roadway.
- Driving at night, in dark areas such as long tunnels.
- Driving in bad weather (rain, fog, snow, etc.).
- Sudden changes between light and dark, such as the entrance or exit of a tunnel or the shadows of trees, buildings, etc.
- Water is sprayed by or snow blown from a vehicle ahead.
- Reflections on the interior of the windscreen.

### ■ Roadway conditions

- Your vehicle is strongly shaken on uneven road surfaces.

### ■ Vehicle conditions

- When lighting is weak due to dirt covering the headlight lenses, or there is poor visibility in a dark place due to the headlights being improperly adjusted.
- The front of the camera is obstructed by dirt, fog, rain, mud, wet snow, accessories, decals, stickers, film, etc.
- There is residue on the windscreen from the windscreen wipers.
- An abnormal tyre or wheel condition (incorrect sizes, varied sizes or construction, improperly inflated, etc.).
- The vehicle is tilted due to heavy luggage in the luggage area or rear seats.
- The suspension has been modified.
- Tyre chains are installed.
- Driving at night or in a dark place (e.g., a tunnel) with the headlights off.
- The inside of the windscreen is fogged.
- The vehicle is towing a trailer.

\* Not available on all models

### ☒ Traffic Sign Recognition System Conditions and Limitations

☒ (amber) appears on the gauge in the following cases. If this message does not disappear, have your vehicle checked by a dealer.

- There is a problem with the Traffic Sign Recognition System
- Immediately after turning on the power system (including when it is started remotely)
- Navigation system map data is being updated.

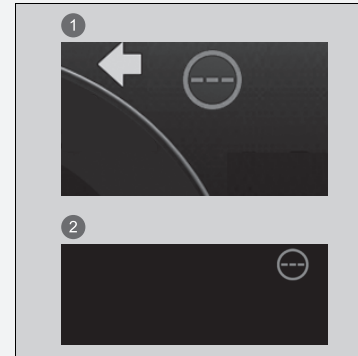

① Gauge

② Head-up Display\*

Continued

■ **The position or the condition of the traffic sign**

- The sign is in a place that makes it hard to find.
- The sign is located far away from your vehicle.
- The sign is located where it is hard for headlight beams to reach.
- The sign is on a corner or bend in the road.
- The sign is faded or bent.
- The sign is rotated or damaged.
- The sign is covered with mud, snow, or frost.
- Part of the sign is hidden by the trees, or is in the shadow of a vehicle or other object.
- Light (such as a streetlight) is reflected on the surface of the sign, or it is hidden in shadow.
- The sign is too bright or too dark (electric signs).
- Small signs (auxiliary signs, etc.).

■ **Other conditions**

- When you are driving at a high speed.

The Traffic Sign Recognition System may not operate correctly, such as displaying signs that do not adhere to the actual regulations for the roadway or do not exist at all in the following cases.

- ▶ A speed limit sign may display at a higher or lower speed than the actual speed limit.
- There is a supplementary sign with further information such as weather, time, vehicle type, etc.
- Figures on the sign are hard to read (electric signs, numbers on the sign are blurred, etc.).
- The sign is in the vicinity of the lane you are driving in, even though it is not for the lane, such as a speed limit sign situated at a junction between the side road and the main road.
- There are things that look similar in colour or shape to recognised objects (similar sign, electric sign, signboard, structure, etc.).

### ■ Situations where correct speed limit sign information cannot be provided for the area

In the following situations, the display may differ from the regulations of the roadway you are driving on, and/or the display may be delayed:

- A new road has been built.
- The speed limit has changed.
- The speed limit information stored in the navigation database is outdated or inaccurate.
- When driving in areas where the information cannot be used or on alleyways without signs.
- The vehicle path that the sensor detected and the actual vehicle path are different.
- There are adjacent roads with speed limits different from the one you are driving on.
- The sign is a temporary speed limit sign with non-standard features (such as design, etc.)
- When driving in a place with poor GNSS reception, such as in tunnels or around skyscrapers.
- The vehicle repeatedly stops and starts at a low speed.
- When driving on a route different from the navigation guidance.
- There are continuous steep slopes or curves.
- There is a variable speed limit.

## ■ Signs Displayed on the Gauge and Head-Up Display\*

Two traffic signs can be simultaneously displayed next to each other when detected. The speed limit sign icon is displayed on the right half of the screen. The overtaking prohibition sign icon appears on the left. Any additional sign that indicated speed limit based on weather (snow, etc.) or specific period of time will appear on the left side.

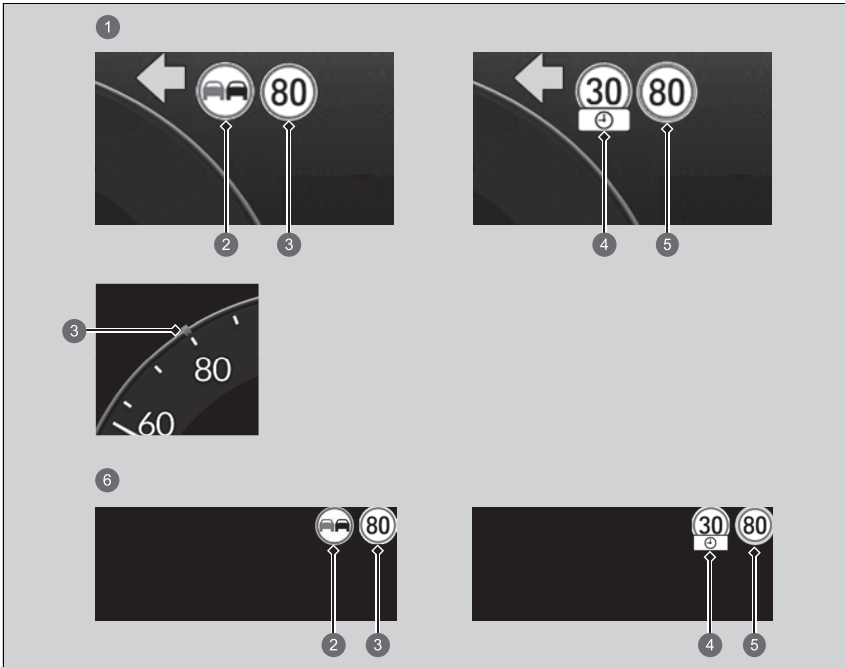

\* Not available on all models

Continued

- ① Gauge
- ② Overtaking Prohibition Sign
- ③ Speed Limit Sign
- ④ Additional Speed Limit Sign Based on Conditions
- ⑤ Suggested Speed Limit (green)
  - ▶ **Applying the Traffic Sign Recognition System's Suggested Speed Limit** P. 530
- ⑥ Head-up Display\*

## Front Sensor Camera

The camera, used in systems such as Collision Mitigation Braking System (CMBS), Front Cross Traffic Warning, Road Departure Mitigation system, Lane Change Collision Mitigation, Adaptive Cruise Control (ACC) with Low Speed Follow, Lane Keeping Assist System (LKAS), Traffic Jam Assist, Active Lane Change Assist, Traffic Sign Recognition system, and Adaptive Driving Beam, is designed to detect an object that triggers any of the systems to operate its functions.

### ■ Camera Location and Handling Tips

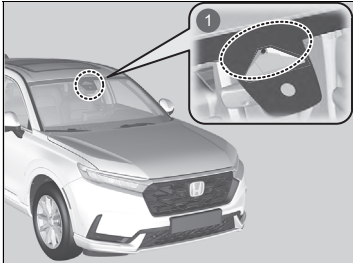

1 Front Sensor Camera

This camera is located behind the rearview mirror.

To help to reduce the likelihood that high interior temperatures will cause the camera's sensing system to shut off, find a shady area or face the front of the vehicle away from the sun when parking. If you use a reflective sun shade, do not allow it to cover the camera housing. Covering the camera can concentrate heat on it.

### ⊠ Front Sensor Camera

Never apply a film or attach any objects to the windshield, the bonnet, or the front grille that could obstruct the camera's field of vision and cause the system to operate abnormally.

Scratches, nicks, and other damage to the windshield within the camera's field of vision can cause the system to operate abnormally. If this occurs, we recommend that you replace the windshield with a genuine Honda replacement windshield. Making even minor repairs within the camera's field of vision or installing an aftermarket replacement windshield may also cause the system to operate abnormally.

After replacing the windshield, have a dealer recalibrate the camera. Proper calibration of the camera is necessary for the system to operate properly.

Do not place an object on the top of the instrument panel. It may reflect onto the windshield and prevent the system from detecting lane lines properly.

#### Front Sensor Camera

If the  **Some driver assist systems cannot operate: Camera temperature too high** message appears:

- Use the climate control system to cool down the interior and, if necessary, also use demister mode with the airflow directed towards the camera.
- Start driving the vehicle to lower the windscreen temperature, which cools down the area around the camera.

If the  **Some driver assist system cannot operate: Clean front windscreen or poor viewing condition.** message appears:

- Park your vehicle in a safe place, and make sure the windscreen is clean.

Clean the windscreen if it is dirty. If the message does not disappear after driven for a while, have your vehicle checked by a dealer.

## Radar Sensor

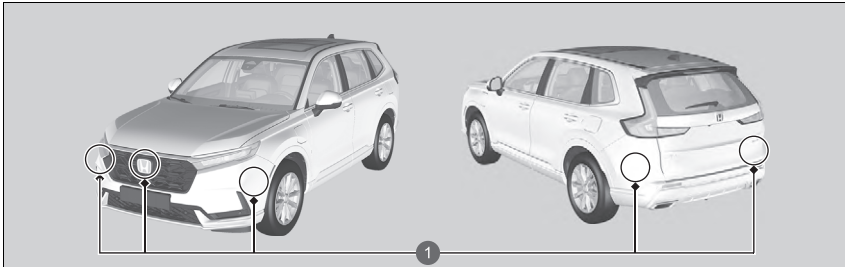

### 1 Radar Sensor

The radar sensor is behind the Honda emblem on the front grille. In addition to the above, radar sensors are also included on the interior sides of the front and rear bumpers.

### ⊠ Radar Sensor

For the system to work properly, observe the following precautions.

- Always keep the area around the sensors clean.
- Never use chemical solvents or polishing powder for cleaning around the sensors. Clean it with water or a mild detergent.
- Do not put any stickers or paint on the area around the sensors.
- Do not scratch or damage the area around the sensors.
- Do not replace the emblem, front grille, or bumper.
- Do not remove or disassemble the radar sensor.

Consult a dealer if:

- The radar sensor cover is strongly impacted.
- The front grille or bumper needs to be repaired.

If the vehicle is involved in any of the following situations, the radar sensor may not work properly.

Have your vehicle checked by a dealer:

- The area around the sensors strongly strikes a bump, curb, chock, slope, or embankment that could jar the radar sensor.
- Your vehicle drives through deep water or is submerged in deep water.
- Your vehicle is involved in a collision.

## Driver Monitoring Camera

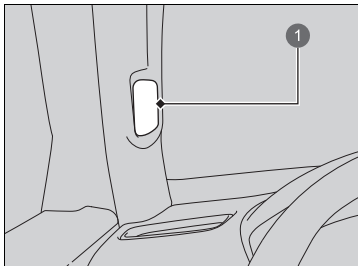

① Driver Monitoring Camera

The driver monitoring camera is used by the Driver Attention Monitor. The camera detects the position of your face and the direction it's facing, as well as your eyes, mouth, and posture.

➤ **Driver Attention Monitor** P. 525

### ▶▶ Driver Monitoring Camera

A red LED light may be visible from the Driver Monitoring Camera. When the driver monitoring camera is suspended, the driver monitoring camera indicator (Grey)  comes on.

Follow the points below for the camera to work properly:

- Do not put weight on the camera or let it receive a strong impact.
- Do not place any items, stickers (including transparent ones), or accessories onto the area around the camera.
- Keep the area around the camera clean.
- Do not remove the camera.

The camera may not properly detect the driver's condition under the following conditions:

- Your face cannot be recognized due to a mask, glasses, sunglasses, etc.
- Your eyes are closed for a while, or you are blinking frequently
- You are squinting or lowering your eyes
- Your head is tilted too far in one direction, or you are looking down.
- Direct sunlight is hitting the driver monitoring camera

## Sonar Sensors

### ■ Location and range of sensors

The sonar sensors are situated in the front and rear bumpers.

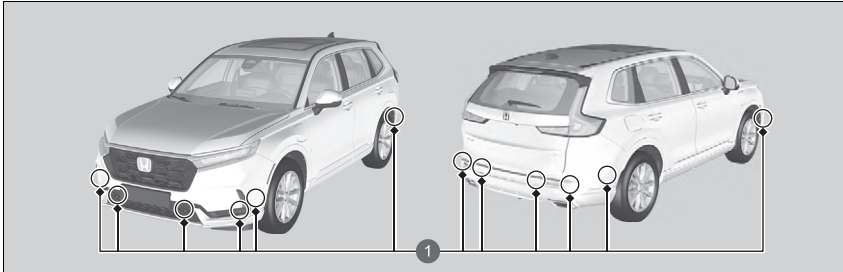

1 Sonar Sensors

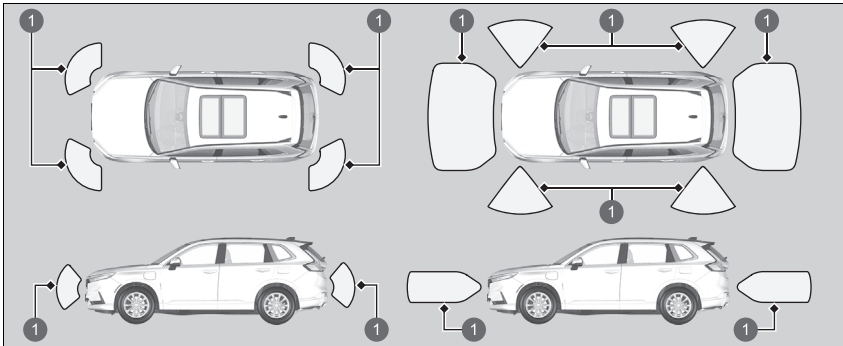

1 Sensor Range

While Honda Parking Pilot is in operation, the sensors located on the sides of the front and rear bumpers can also operate.

### ⊠ Sonar Sensors

For the sonar sensors to work properly, do not:

- Place stickers or other objects on or around the sensors.
- Hit the area around the sensors.
- Attempt to take apart any sensor.
- Put any accessories on or around the sensors.

Consult with a dealer if:

- A sensor has been subjected to shock.
- Work needs to be done to the area around a sensor.

In the following cases, the sonar sensors may not work properly. Have your vehicle checked by a dealer.

- The front or rear bumper has made contact with a hill, parking block, curb, embankment, etc.
- The vehicle has been involved in frontal or rear collision.
- The vehicle has been driven through a deep puddle.

## Brake System

### ■ Parking Brake

Use the parking brake to keep the vehicle stationary when parked. When the parking brake is applied, you can manually or automatically release it.



1 Electric Parking Brake Switch

#### ■ To apply

The electric parking brake can be applied any time the vehicle has 12-volt battery, no matter which position the power mode is in.

Pull the electric parking brake switch up gently and securely.

- ▶ The indicator in the switch comes on.
- ▶ The parking brake and brake system indicator (red) comes on.

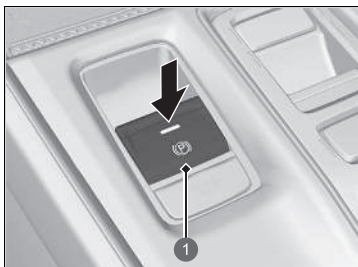

1 Electric Parking Brake Switch

#### ■ To release

The power mode must be in ON in order to release the electric parking brake.

1. Depress the brake pedal.
2. Press the electric parking brake switch.
  - ▶ The indicator in the switch goes off.
  - ▶ The parking brake and brake system indicator (red) goes off.

Manually releasing the parking brake using the switch helps your vehicle to start slowly and smoothly when facing downhill on steep hills.

#### » Brake System

When you depress the brake pedal, you may hear a whirring sound from the engine compartment. This is because the brake system is in operation, and it is normal.

#### » Parking Brake

You may hear the electric parking brake system motor operating from the rear wheel area when you apply or release the parking brake. This is normal.

The brake pedal may slightly move due to the electric parking brake system operation when you apply or release the parking brake. This is normal.

You cannot apply or release the parking brake if the 12-volt battery goes dead.

▶ **If the 12-Volt Battery Is Dead** P. 753

**If you pull up and hold the electric parking brake switch while driving, the brakes on all four wheels are applied by the electric servo brake system until the vehicle comes to a stop. The electric parking brake then applies, and the switch should be released.**

## ■ Automatic parking brake feature operation

If the automatic parking brake feature has been activated:

- The parking brake is applied automatically when you set the power mode to VEHICLE OFF.
- To confirm that the parking brake is applied, check if the parking brake and brake system indicator is (red) on.
  - ▶ **Activating and deactivating the automatic parking brake feature** P. 592

## ■ To release automatically

Depressing the accelerator pedal releases the parking brake.

Use the accelerator pedal to release the parking brake when you are starting the vehicle facing uphill, or in a traffic jam.

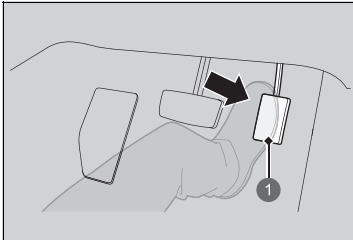

Gently depress the accelerator pedal.

When on a hill, it may require more accelerator input to release.

- ▶ The parking brake and brake system indicator (red) goes off.

### ① Accelerator Pedal

You can release the parking brake automatically when:

- You are wearing the driver's seat belt.
- The power system is on.
- The transmission is not in **P** or **N**.

## ⊠ Parking Brake

In the following situations, the parking brake automatically operates.

- When the vehicle stops more than 10 minutes while Adaptive Cruise Control (ACC) with Low Speed Follow is activated.
- When the driver's seat belt is unfastened while your vehicle is stopped automatically by ACC with Low Speed Follow.
- When the power system is turned off while ACC with Low Speed Follow is activated.
- When the vehicle stops with the automatic brake hold system activated for more than 10 minutes.
- When the driver's seat belt is unfastened while your vehicle is stopped and brake hold is applied.
- When the power system is turned off while brake hold is applied.
- When there is a problem with the Brake Hold System while brake hold is applied.

If the parking brake cannot be released automatically, release it manually.

When the vehicle is travelling uphill, the accelerator pedal may need to be pressed farther to automatically release the electric parking brake.

The parking brake cannot be released automatically while the following indicators are on:

- Malfunction indicator lamp
- Transmission system indicator

### ■ Activating and deactivating the automatic parking brake feature

With the power mode is in ON, carry out the following steps to either activate or deactivate the automatic parking brake feature.

1. Put the transmission into **P**.
2. Without depressing the brake pedal, pull up and release the electric parking brake switch.
  - Check that the parking brake and brake system indicator (red) has come on.
3. Pull up and hold the electric parking brake switch. When you hear a beeping sound, release the switch and within three seconds pull up and hold the switch again.
4. When you hear a sound indicating that the procedure is completed, release the switch.
  - Two beeps indicate that the feature has been activated.
  - One beep indicates that the feature has been deactivated.
  - When you have completed activating the feature, the parking brake will remain applied after you turn the power system off.
  - To confirm that the parking brake is applied, check if the parking brake and brake system indicator (red) is on.

If you need to temporarily deactivate the feature when having your vehicle towed, you can follow the procedure explained below.

1. Depress the brake pedal and bring the vehicle to a stop.
2. Set the power mode to VEHICLE OFF and then within two seconds push down the electric parking brake switch.
  - Activation and deactivation settings for the feature will not be affected.
  - Before temporarily deactivating the feature, make sure to first turn off both ACC with Low Speed Follow and the automatic brake hold system.
  - To confirm that the parking brake is applied, check if the parking brake and brake system indicator (red) is on.

#### ►► Parking Brake

The parking brake may not be released automatically while the following indicators are on:

- Parking brake and brake system indicator (amber)
- VSA system indicator
- **ABS** indicator
- Supplemental restraint system indicator

#### ►► Activating and deactivating the automatic parking brake feature

In cold climates, the parking brake may freeze in place if applied.

When parking the vehicle, chock the wheels and make sure the automatic parking brake feature is deactivated.

Also, when putting your vehicle through a conveyor-type car wash or when having your vehicle towed, deactivate the automatic parking brake feature and leave the parking brake released.

## Foot Brake

Your vehicle is equipped with disc brakes at all four wheels. The brake assist system increases the stopping force when you depress the brake pedal hard in an emergency situation. The anti-lock brake system (ABS) helps you to retain steering control when braking very hard.

➤ **Brake Assist System** P. 598

➤ **Anti-lock Brake System (ABS)** P. 597

## Foot Brake

Check the brakes after driving through deep water, or if there is a buildup of road surface water. If necessary, dry the brakes by lightly depressing the pedal several times.

If you hear a continuous metallic friction sound when applying the brakes, the brake pads need to be replaced. Have your vehicle checked by a dealer.

Applying constant pressure to the brakes while going down a long hill can cause the brakes to heat up, resulting in a loss of stopping power.

Therefore, when descending a long hill, release the accelerator pedal and allow regenerative braking to slow the vehicle down.

To adjust the rate of deceleration, use the deceleration paddle selector.

When the high voltage battery has fully recharged, regenerative braking may not be possible.

➤ **CHARGE/DECEL Gauge** P. 158

➤ **High Voltage Battery Charge Level Gauge**  
P. 158

➤ **Deceleration Paddle Selector** P. 440

Do not rest your foot on the brake pedal while driving, as it will lightly apply the brakes and cause them to lose effectiveness over time and reduce pad life. It will also confuse drivers behind you.

## Automatic Brake Hold

Keeps the brake applied after releasing the brake pedal until the accelerator pedal is pressed. You can use this system while the vehicle is temporarily stopped, like at traffic lights and in heavy traffic.

### Turning on the system

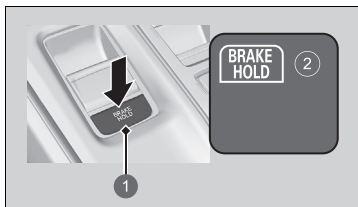

- 1 Automatic Brake Hold Button
- 2 Comes On

Fasten your seat belt properly, then turn the power system on. Press the automatic brake hold button.

- The automatic brake hold system indicator comes on. The system is turned on.

The system is in the previously selected on or off setting each time you fasten the driver's seat belt and turn the power system on.

## Automatic Brake Hold

### ⚠ WARNING

Activating the automatic brake hold system on steep hills or slippery roads may still allow the vehicle to move if you remove your foot from the brake pedal.

If a vehicle unexpectedly moves, it may cause a crash resulting in serious injury or death.

Never activate the automatic brake hold system or rely on it to keep a vehicle from moving when stopped on a steep hill or slippery roads.

### ⚠ WARNING

Using the automatic brake hold system to park the vehicle may result in the vehicle unexpectedly moving.

If a vehicle moves unexpectedly, it may cause a crash, resulting in serious injury or death.

Never leave the vehicle when braking is temporarily kept by automatic brake hold and always park the vehicle by putting the transmission in **P** and applying the parking brake.

## ■ Activating the system

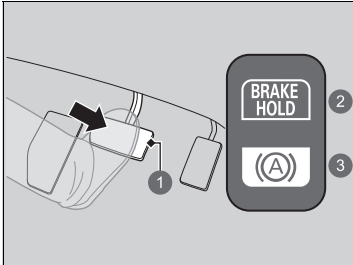

- ① Brake Pedal
- ② On
- ③ Comes On

Depress the brake pedal to come to a complete stop. The transmission must not be in **P** or **R**.

- ▶ The automatic brake hold indicator comes on. Braking is kept for up to 10 minutes.
- ▶ Release the brake pedal after the automatic brake hold indicator comes on.

## ■ Cancelling the system

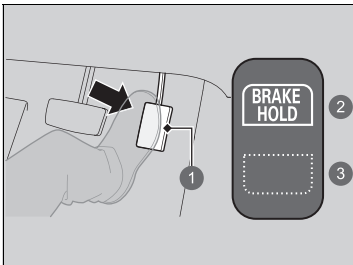

- ① Accelerator Pedal
- ② On
- ③ Goes Off

Depress the accelerator pedal while the transmission is in a position other than **P** or **N**. The system is cancelled and the vehicle starts to move.

- ▶ The automatic brake hold indicator goes off. The system continues to be on.

### Automatic Brake Hold

## ⚠ WARNING

When using the automatic brake hold, keep your foot on the brake pedal until the automatic brake hold indicator comes on.

If the vehicle unexpectedly moves, it may cause a crash resulting in serious injury or death.

Release your foot from the brake pedal after the automatic brake hold indicator comes on.

■ **The system automatically cancels when:**

- You engage the parking brake.
- You depress the brake pedal and put the transmission into **P** or **R**.

■ **The system automatically cancels and the parking brake is applied when:**

- Braking is kept for more than 10 minutes.
- The driver's seat belt is unfastened.
- The power system is turned off.
- There is a problem with automatic brake hold system.

■ **Turning off the automatic brake hold system**

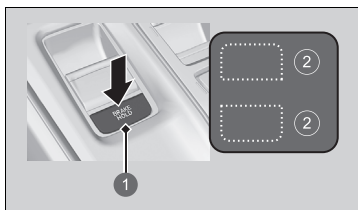

- ① Automatic Brake Hold Button
- ② Goes Off

Only the automatic brake hold system indicator comes on:

- Press the automatic brake hold button.
  - The automatic brake hold system indicator goes off.

When the automatic brake hold indicator comes on at the same time:

- Press the automatic brake hold button with the brake pedal depressed.
  - The automatic brake hold system indicator and the automatic brake hold indicator go off.

►► Automatic Brake Hold

While the system is activated, you can turn the power system off or park the vehicle through the same procedure as you normally do.

► **When Stopped** P. 600

You may hear an operating noise if the vehicle moves while the automatic brake hold system is in operation.

►► Turning off the automatic brake hold system

Make sure to turn off the automatic brake hold system before using an automated car wash.

If you turn the power system off or unfasten the driver's seat belt while the automatic brake hold system is on, the automatic brake hold system will automatically turn off.

In this case, when the driver's seat belt is fastened and the power system is turned back on, the automatic brake hold system will turn on without needing to press the automatic brake hold button.

## Anti-lock Brake System (ABS)

### ■ ABS

Helps to prevent the wheels from locking up, and helps you to retain steering control by pumping the brakes rapidly, much faster than you can.

The electronic brake distribution (EBD) system, which is part of the ABS, also balances the front-to-rear braking distribution according to vehicle loading.

You should never pump the brake pedal. Let the ABS work for you by always keeping firm, steady pressure on the brake pedal. This is sometimes referred to as “stomp and steer.”

### ■ ABS operation

The brake pedal may pulsate slightly when the ABS is working. Depress the brake pedal and keep holding the pedal firmly down. On dry pavement, you will need to press on the brake pedal very hard before the ABS activates. However, you may feel the ABS activate immediately if you are trying to stop on snow or ice.

ABS may activate when you depress the brake pedal when driving on:

- Wet or snow covered roads.
- Roads paved with stone.
- Roads with uneven surfaces, such as potholes, cracks, manholes, etc.

When the vehicle speed goes under 10 km/h (6 mph), the ABS stops.

### ⓘ Anti-lock Brake System (ABS)

#### NOTICE

The ABS may not function correctly if you use a tyre of the incorrect size or type.

If the **ABS** indicator comes on while driving, there may be a problem with the system. While normal braking will not be affected, there is a possibility that the ABS will not be operating. Have your vehicle checked by a dealer immediately.

The ABS is not designed for the purpose of reducing the time or distance it takes for a vehicle to stop: It is designed to limit brake lockup which can lead to skidding and loss of steering control.

In the following cases, your vehicle may need more distance to stop than a vehicle without the ABS:

- You are driving on rough or uneven road surfaces, such as gravel or snow.
- The tyres are equipped with tyre chains.

The following may be observed with the ABS system:

- Motor sounds coming from the engine compartment when the brakes are applied, or when system checks are being performed after the power system has been turned on and while the vehicle accelerates.
- Brake pedal and/or the vehicle body vibration when ABS activates.

These vibrations and sounds are normal to ABS systems and are no cause for concern.

## Brake Assist System

---

Is designed to assist the driver by generating greater braking force when you depress the brake pedal hard during emergency braking.

### ■ Brake assist system operation

Press the brake pedal firmly for more powerful braking.

When brake assist operates, the pedal may wiggle slightly and an operating noise may be heard. This is normal. Keep holding the brake pedal firmly down.

## Emergency Stop Signal

Activates when you brake hard while driving at 60 km/h (37 mph) or above to alert drivers behind you about sudden braking by rapidly flashing hazard warning lights. This may help to alert drivers behind you to take appropriate means to avoid a possible collision with your vehicle.

### ■ When the system activates:

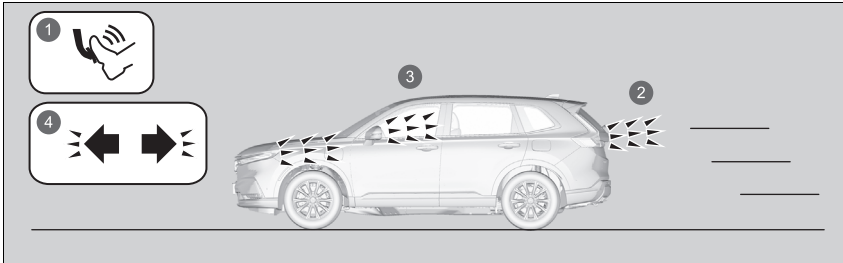

- ① Hard Braking
- ② Brake Lights Come On
- ③ Hazard Warning Lights Flash
- ④ Hazard Warning Indicators Blink

The hazard warning lights stop flashing when:

- You release the brake pedal.
- The ABS is deactivated.
- Your vehicle's decelerating speed becomes moderate.
- You press the hazard warning button.

### ☒ Emergency Stop Signal

The emergency stop signal is not a system that can prevent a possible rear-end collision caused by your hard braking. It flashes the hazard warning lights at the time you are braking hard. It is always recommended to avoid hard braking unless it is absolutely necessary.

The emergency stop signal does not activate with the hazard warning button pressed in.

If the ABS stops working for a certain period during braking, the emergency stop signal may not activate at all.

## When Stopped

1. Depress the brake pedal firmly and come to a complete stop.
2. With the brake pedal depressed, pull up the electric parking brake switch slowly, but fully.
3. Put the transmission into **P**.
  - ▶ Do not release the brake pedal until you have confirmed that **P** is shown on the shift position indicator.
4. Turn the power system off.
  - ▶ The parking brake and brake system indicator (red) goes off in about 30 seconds.

Always set the parking brake, in particular if you are parked on an incline.

### ▣ Parking Your Vehicle

#### **WARNING**

The vehicle can roll away if left unattended without confirming that Park is engaged.

A vehicle that rolls away could cause a crash resulting in serious injury or death.

Always keep your foot on the brake pedal until you have confirmed that **P** is shown on the shift position indicator.

Do not park your vehicle near flammable objects, such as dry grass, oil, or timber. Heat from the exhaust can cause a fire.

## »» When Stopped

**NOTICE**

The following can damage the driveline:

- Depressing the accelerator and brake pedals simultaneously.
- Putting the transmission into **P** before the vehicle stops completely.

When facing uphill, do not hold the vehicle by depressing the accelerator pedal.

Doing so may cause the power system to overheat and fail.

In extremely cold temperatures, the parking brake may freeze up if applied. If such temperatures are expected, do not apply the parking brake but, if parking on a slope, either turn the front wheels so they will contact the curb if the vehicle rolls down the slope or block the wheels to keep the vehicle from moving. If you do not take either precaution, the vehicle may roll unexpectedly, leading to a crash.

## Parking Sensor System

The corner, side and centre sensors monitor obstacles around your vehicle, and the beeper, driver information interface and audio/information screen let you know the approximate distance between your vehicle and the obstacle.

### ■ The sensor location and range

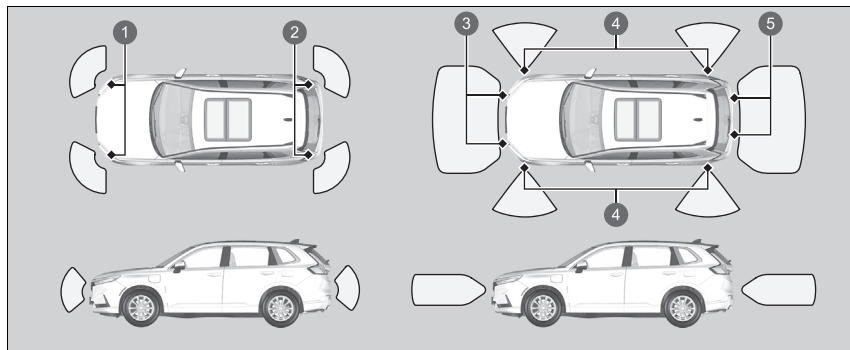

- ① Front Corner Sensors
- ② Rear Corner Sensors
- ③ Front Centre Sensors
- ④ Side Sensors
- ⑤ Rear Centre Sensors

### ▶ Parking Sensor System

Even when the system is on, always confirm if there is no obstacle near your vehicle before parking.

The system may not work properly when:

- The sensors are covered with snow, ice, mud, or dirt.
- The vehicle is on uneven surface, such as grass, bumps, or a hill.
- The vehicle has been out in hot or cold weather.
- There is something nearby that emits ultrasonic waves or high frequency sounds.
- Driving in bad weather (rain, fog, snow, etc.).

The system may not detect these obstacles:

- Thin or low objects.
- Sonic-absorptive materials, such as snow, cotton, or sponge.
- Objects directly under the bumper.

The system may falsely detect obstacles in the following situations:

- The vehicle is on uneven surface, such as grass, bumps, or a hill.
- When close to other vehicles with sonar sensors or other objects that emit ultrasonic waves.
- There is splashing water near the sensors due to heavy rains, etc.

Do not put any accessories on or around the sensors.

▶ If you put any accessories (such as a towing hitch or bicycle rack) on or around the rear sensors, the system may activate if it detects these accessories as an obstacle. In this case, turn off the rear sensor.

#### ▶ How to Customize the Vehicle Settings

P. 368

## ■ Parking sensor system on and off

You can turn the system on and off using the driver information interface. The beeper and the warning display are turned off.

➤ **Switching the Display** P. 164

➤ **Safety Support** P. 173

The front corner, rear centre and rear corner sensors start to detect an obstacle when the transmission is in **[R]**, and the vehicle speed is less than 9 km/h (6 mph).

The front corner and front centre sensors start to detect an obstacle when the transmission is in any position other than **[P]** or **[R]**, and the vehicle speed is less than 9 km/h (6 mph).

When Honda Parking Pilot is in operation, the Parking Sensor System will turn on, and all parking sensors will start to monitor obstacles while the vehicle speed is less than 9 km/h (6 mph).

### ☒ Parking sensor system on and off

When you set the power mode to ON, the system will be in the previously selected condition.

You can turn the rear parking sensor system on and off using the audio/information screen.

➤ **How to Customize the Vehicle Settings**  
P. 368

When the vehicle is moving forward at 9 km/h (6 mph) or less, the system detects any obstacles in front of the vehicle and the forward camera image will display as the distance between them decreases.

➤ **Multi-View Camera** P. 612

You can customize whether or not to display the forward camera image when an obstacle is detected.

➤ **Customized Features** P. 360

When the Drive Mode is in **TOW** mode, the rear parking sensor system will turn off.

➤ **Drive Mode Switch** P. 445

## ■ Screen Operation

You can switch between split view off and split view on by touching the split screen tab.

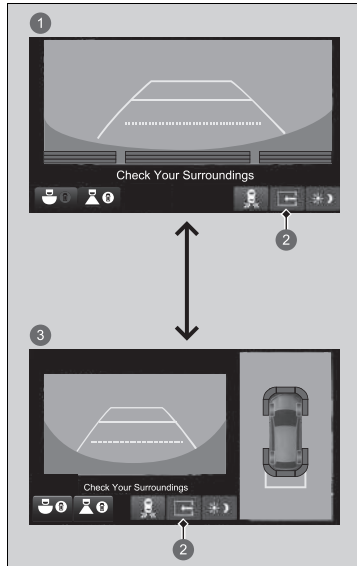

- ① Split View Off
- ② Split Screen Tab
- ③ Split View On

■ When the distance between your vehicle and detected obstacles becomes shorter



**Parking Sensor Indicator**

The parking sensor indicator blinks.

▶ If the system is turned off, only the parking sensor indicator will blink when an obstacle is detected.

Interval between beeps	Distance between the Bumper and Obstacle			Indicator	Driver information interface	Audio/Information screen
	Corner Sensors	Centre Sensors	Side Sensors*4			
Moderate	—	Front: About 70-60cm (27-23 inches) Rear: About 110-75cm (43-29 inches)	—	Comes on*1/ Blinks*2 in Yellow*3		
Short	Front: About 55-45cm (21-17 inches) Rear: About 60-45cm (23-17 inches)	Front: About 60-50cm (23-19 inches) Rear: About 75-60cm (29-23 inches)	—	Comes on*1/ Blinks*2 in Amber*5		
Very short	Front/Rear: About 45-35cm (17-13 inches)	Front: About 50-40cm (19-15 inches) Rear: About 60-50cm (23-19 inches)	About 45-35 cm (17-13 inches)*5			
Continuous	Front/Rear: About 35cm (13 inches) or less	Front: About 40cm (15 inches) or less Rear: About 50cm (19 inches) or less	About 35 cm (13 inches) or less*5	Comes on*1/ Blinks*2 in Red*5		

\*1: On the driver information interface

\*2: On the audio/information screen

\*3: At this stage, only the centre sensors detect obstacles.

\*4: While Honda Parking Pilot is in operation, the sensors located on the sides of the front and rear bumpers can also operate.

\*5: While Honda Parking Pilot is in operation, the intermittent beep sounds continuously or very short, and the indicator blinks in red or amber.

① Indicators light up where the sensor detects an obstacle.

To temporarily turn off the beeper, press the right selector wheel while it is sounding. Temporary OFF will be cancelled when the shift position is switched or the vehicle speed reaches 14 km/h (8 mph) or higher.

## Cross Traffic Monitor

Monitors the rear corner areas using the radar sensors when reversing, and alerts you if a vehicle approaching from a rear corner is detected.

The system is convenient when you are backing out of a parking space.

### ⓘ Cross Traffic Monitor

#### **⚠ WARNING**

Cross traffic monitor cannot detect all approaching vehicles and may not detect an approaching vehicle at all.

Failure to visually confirm that it is safe to back up the vehicle before doing so may result in a collision.

Do not solely rely on the system when reversing; always also use your mirrors, and look behind and to the sides of your vehicle before reversing.

The parking sensor system's alerting buzzer overrides the cross traffic monitor buzzer when the sensors are detecting obstacles at the closest range.

*Continued*

## ■ How the System Works

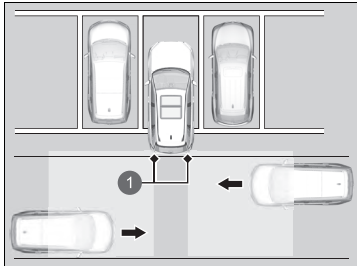

- ① Radar sensors:  
Underneath the rear bumper corners.

When a vehicle is detected approaching from a rear corner, Cross Traffic Monitor alerts you with a buzzer and a displayed warning.

The system activates when:

- The power mode is in ON.
- The Cross Traffic Monitor is turned on.
- The transmission is in **R**.
- Your vehicle is moving at 5 km/h (3 mph) or lower.

➔ **Cross Traffic Monitor On and Off** P. 611

## ☒ Cross Traffic Monitor

Cross traffic monitor may not detect or may delay detecting an approaching vehicle, or may alert detection without an approaching vehicle under the following conditions:

- An obstacle, such as another vehicle and a wall, near your vehicle's rear bumper, is blocking the radar sensor's scope.
- Your vehicle is moving at the speed of about 5 km/h (3 mph) or higher.
- A vehicle is approaching at the speed other than between about 10 km/h (6 mph) and 25 km/h (16 mph).
- The system picks up external interference such as other radar sensors from another vehicle or strong radio wave transmitted from a facility nearby.
- Either corner of the rear bumper is covered with snow, ice, mud or dirt.
- When there is bad weather.
- Your vehicle is on an incline.
- Your vehicle is tilted due to a heavy luggage in the rear.
- Your vehicle is reversing towards a wall, a pole, a vehicle, and so on.
- Driving on snowy or slippery roads.
- When driving for long distances on a road in a trafficless area such as a desert.

The rear bumper or the sensors have been improperly repaired or the rear bumper has been deformed.

Have your vehicle checked by a dealer.

The system will not detect a vehicle that approaches from directly behind your vehicle, nor will it provide alerts about a detected vehicle when it moves directly behind your vehicle.

The system does not provide alerts for a vehicle that is moving away from your vehicle, and it may alert for pedestrians, bicycles, or stationary objects.

☒ Cross Traffic Monitor

For proper operation, always keep the rear bumper corner area clean.  
Do not cover the rear bumper corner area with labels or stickers of any kind.

*Continued*

## ■ When the System Detects a Vehicle

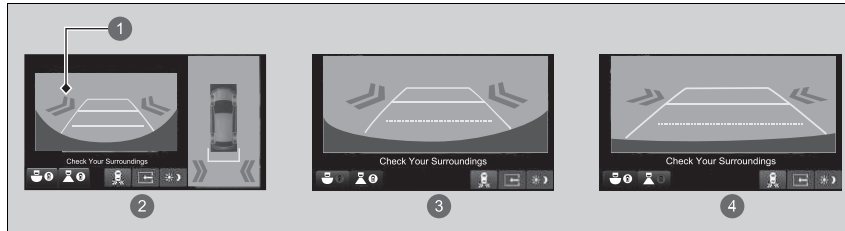

- ① Arrow Icon
- ② Rear Ground View
- ③ Rear Wide View
- ④ Rear Normal View

An arrow icon appears on the side a vehicle is approaching on the audio/information screen.

## ▶▶ When the System Detects a Vehicle

If the on the lower right changes to in amber when the transmission is in **R**, mud, snow, ice and other debris may have accumulated in the vicinity of the sensor. The system is temporarily cancelled. Check the bumper corners for any obstructions, and thoroughly clean the area if necessary.

If the comes on when the transmission is in **R**, there may be a problem with the Cross Traffic Monitor system. Do not use the system and have your vehicle checked by a dealer.

If the display remains the same with the transmission in **R**, there may be a problem with the rear camera system and the Cross Traffic Monitor system. Do not use the system and have your vehicle checked by a dealer.

## ■ Cross Traffic Monitor On and Off

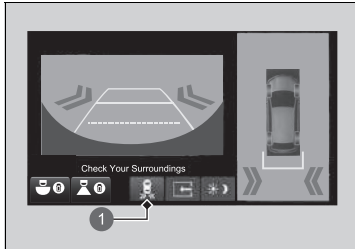

The system can be turned on and off on the audio/information screen by pressing the Cross Traffic Monitor icon.

You can also switch the system on and off from the customized feature on the audio/information screen.

▶ **Customized Features** P. 360

1 Cross Traffic Monitor Icon

Is a four camera system that views areas commonly known as “blind spots” from different angles, then displays the images on the audio/information screen. This system can be used to:

- Check for obstacles when you are moving in **R**.
  - **Checking for Obstacles at the Back of Your Vehicle** P. 619
- Check the right and left sides of the vehicle while crossing at intersections with poor visibility (obstructed view, etc.).
  - **Checking from the front blind view at intersections** P. 623
- Check for obstacles in front of the vehicle when parking or maneuvering in confined areas.

## Multi-View Camera

### **WARNING**

Failure to visually assess the area around the vehicle (directly or by use of the mirrors) may result in a crash causing serious injury or death.

The areas shown in the multi-view camera system display are limited. The display may not show all pedestrians or other objects around your vehicle.

Do not solely rely only on the multi-view camera system display to assess whether it is safe to move your vehicle.

### **WARNING**

Failure to pay proper attention to your surroundings while driving may result in a crash causing serious injury or death.

To help mitigate the chances of a collision, only look at the multi-view camera system display when it is safe to do so.

The multi-view camera system does not eliminate all blind spots. The system is for your convenience only.

## ■ Displaying an Image From the Multi-View Cameras

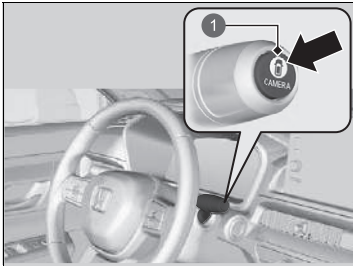

1 **CAMERA** Button

### ■ For frontal views:

Press the **CAMERA** button or select **Multi View Camera** when the vehicle is stationary or moving at 20 km/h (12 mph) or slower. Press the button again to switch camera views.

### ■ For rear views:

Change the shift position to **R** when the vehicle is stationary. Press the **CAMERA** button again to switch to rear view mode. You can customize the display setting.

➤ **Customized Features** P. 360

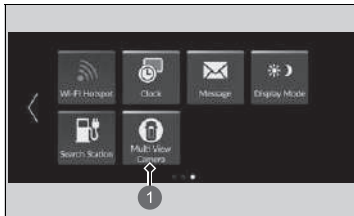

1 **Multi View Camera**

## ▶▶ Multi-View Camera

Always keep the camera lenses clean and free from debris.

If the rear camera lens is covered with dirt or moisture, activate the rearview camera washer or use a soft, moist cloth to keep the lens clean and free of debris.





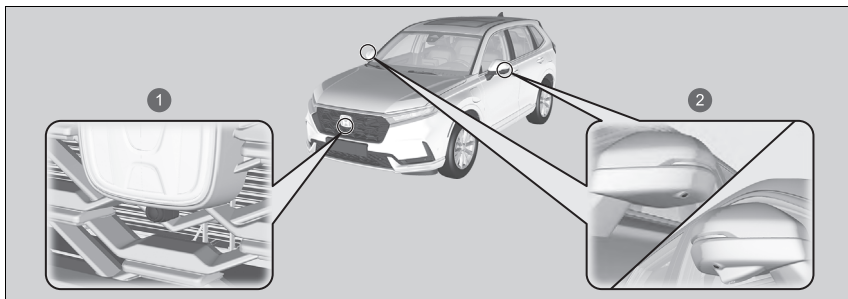



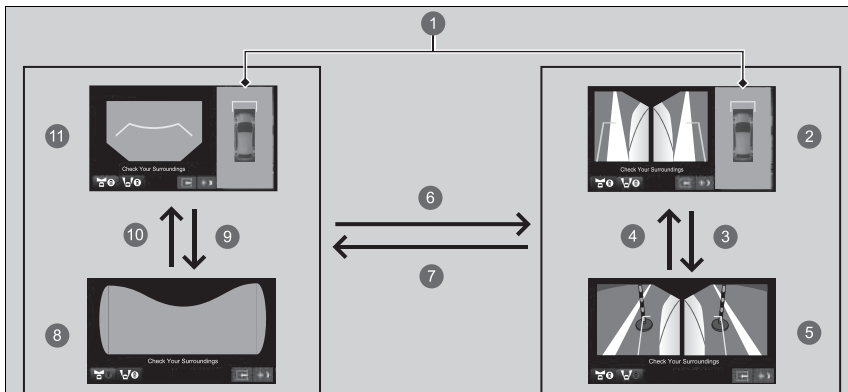











➤ **Rear Wiper/Washer** P. 243

## ■ Camera Locations and Images



- 1 Front View Camera
- 2 Side View Cameras



- 1 Ground View: An overhead view created by the combination of images captured by four cameras.
- 2 Left and Right Side View + Ground View
- 3   or 
- 4   or 
- 5 Left and Right Side View
- 6   or   or **CAMERA** button
- 7   or  
- 8 Front Blind View
- 9   or 
- 10   or 
- 11 Front View + Ground View

The unique multi-view camera lenses make distances appear differently than they actually are - objects seen on the audio/information screen may appear closer or further away, and may be distorted. This becomes more apparent the further away an object is from your vehicle.

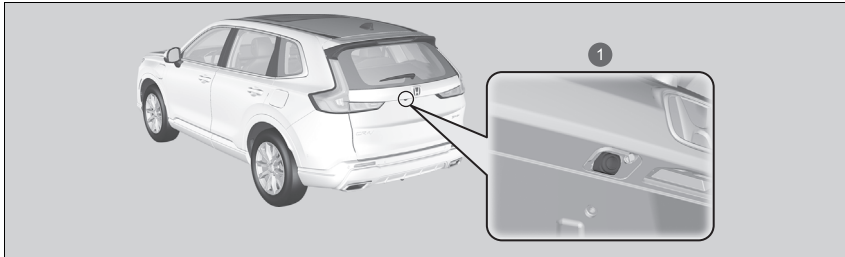



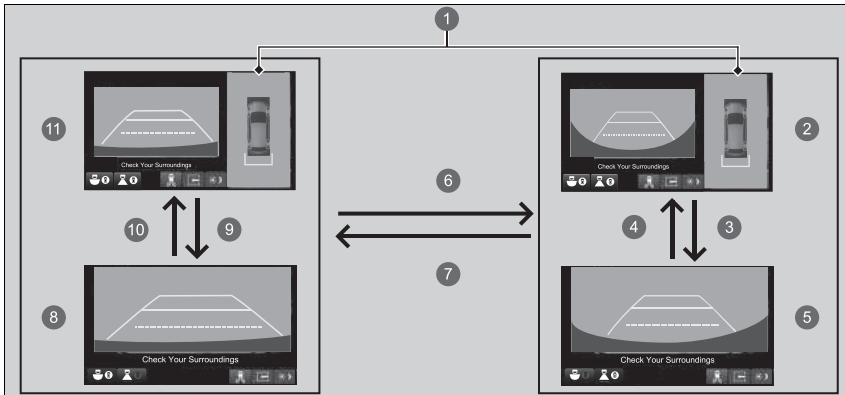







1 Rear View Camera



1 Ground View: An overhead view created by the combination of images captured by four cameras.

2 Rear Wide View + Ground View

3 or

- 4  or 
- 5 Rear Wide View
- 6  or  or **CAMERA** button
- 7  or  or **CAMERA** button
- 8 Rear Normal View
- 9  or 
- 10  or 
- 11 Rear Normal View + Ground View

The unique multi-view camera lenses make distances appear differently than they actually are - objects seen on the audio/information screen may appear closer or further away, and may be distorted. This becomes more apparent the further away an object is from your vehicle.

## ■ Reference Lines and Guide Lines

Following can be displayed when the multi-view camera system is on.

**Fixed Guideline:** Helps you to get a sense of a distance between your vehicle and the surroundings. The distance may appear differently than the actual distance.

**Dynamic Guideline:** Indicates vehicle direction while the steering wheel is in the current position.

## ▶▶ Displaying an Image From the Multi-View Cameras

The navigation system is disabled when the shift position is in **R**.

If you press the **CAMERA** button or select **Multi View Camera** while the vehicle speed is more than 25 km/h (15 mph), the standby screen appears. When the vehicle speed is reduced below 20 km/h (12 mph), the screen switches to a multi-view camera system image.

The positions/distances indicated by the guidelines and camera views on the display may differ from the actual positions/distances due to the changes in the vehicle height, road conditions, and other factors. The guidelines should be used as a reference only.

The guidelines can be turned on and off using the audio/information screen.

▶▶ **Customized Features** P. 360

If you turn the guidelines off, they remain off until you turn them back on.

## ■ Using the Multi-View Camera

### ■ Checking for Obstacles at the Back of Your Vehicle

The display automatically changes to the rear view when the shift position is changed to **R**.

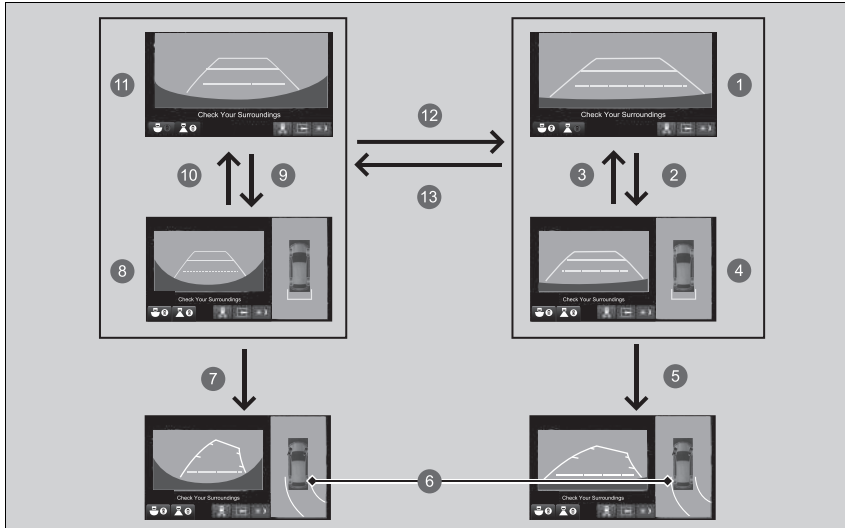





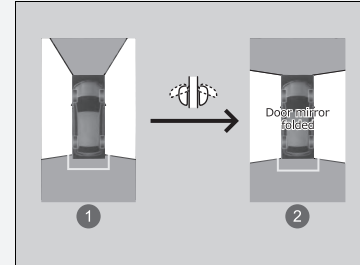







### ☒ Using the Multi-View Camera

The ground view can be displayed even with the door mirrors folded. However, the viewable angle and blind spot change.



- ① Not folded
- ② Folded

Continued

- 1 Rear Normal View
- 2  or 
- 3  or 
- 4 Rear Normal View + Ground View
- 5 When the steering wheel is turned more than 90 degrees.
- 6 The projection lines appear 35 cm (13.8 inches) outside the vehicle body.
- 7 When the steering wheel is turned more than 90 degrees.
- 8 Rear Wide View + Ground View
- 9  or 
- 10  or 
- 11 Rear Wide View
- 12  or  or **CAMERA** button
- 13  or  or **CAMERA** button

▶▶ Checking for Obstacles at the Back of Your Vehicle

When changing the shift position from/to **[R]**, you may experience a delay in switching between the audio/information screen and a rear view image.

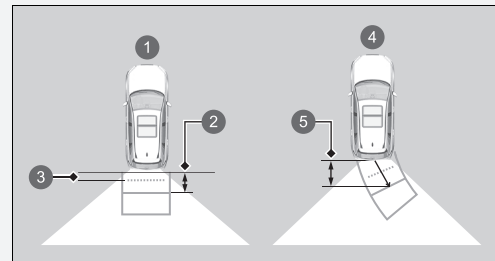

Approximate distances:

- 1 The guidelines indicate
- 2 1.1 m (43.3 inches)
- 3 80 cm (31.5 inches)
- 4 The projection lines indicate
- 5 1.1 m (43.3 inches)

### ■ Checking for the Sides of Your Vehicle

You can display the front ground view screen using all the four cameras for the system. Pressing the **CAMERA** button when the vehicle speed is at below 20 km/h (12 mph) changes the image as follows.

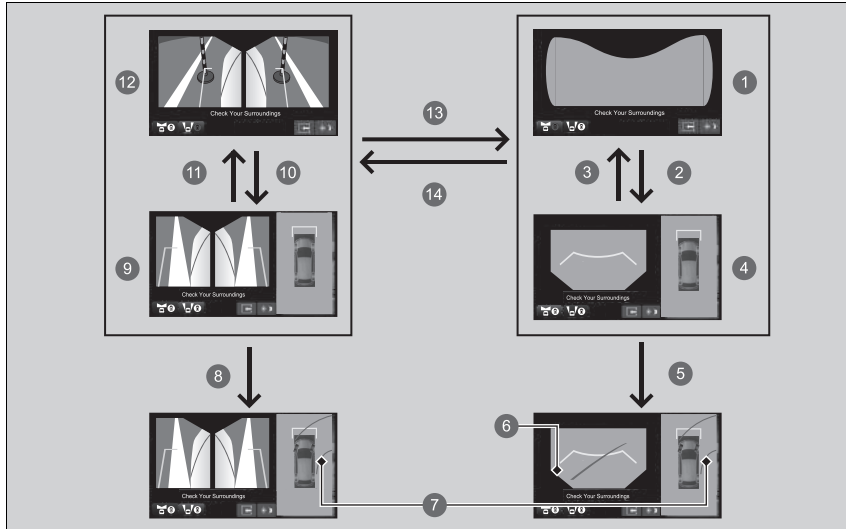

### ☒ Checking for the Sides of Your Vehicle

While the image from the multi-view cameras is being displayed if the vehicle speed exceeds 25 km/h (15 mph), the front or side view on the screen automatically switches to the audio/information screen.

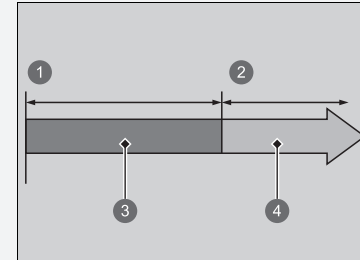

- 1 0 km/h (0 mph)
- 2 25 km/h (15 mph)
- 3 Camera Screen
- 4 Audio/Information Screen

Continued

1 Front Blind View



4 Front View + Ground View

5 When the steering wheel is turned more than 90 degrees.

6 Blind spots appear in black.

7 The projection lines appear 35 cm (13.8 inches) outside the vehicle body.



8 When the steering wheel is turned more than 90 degrees.

9 Left and Right Side View + Ground View



12 Left and Right Side View



14  or  or **CAMERA** button

▶▶ Checking for the Sides of Your Vehicle

Approximate distance the reference line indicates

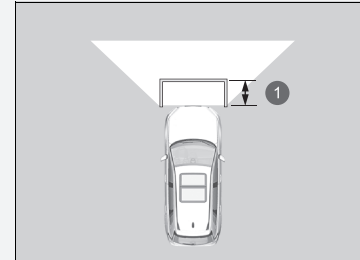

1 1.1 m (43.3 inches)

## ■ Checking from the front blind view at intersections

The front blind view screen is useful when you need to check for vehicles crossing from either direction at an intersection with poor visibility.

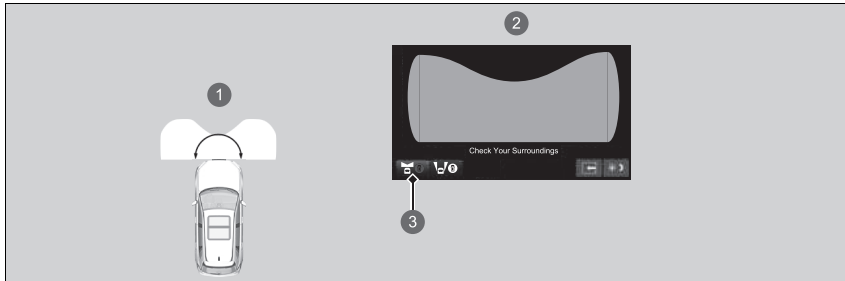

- ❶ The angle provided by the front blind view screen is 180 degrees.
- ❷ Front Blind View Screen
- ❸ When pressing the **CAMERA** button or selecting **Multi View Camera** and Front blind view icon.





## ☒ Checking from the front blind view at intersections

The front blind view is a wide-angled view. The image will be largely distorted, and objects may appear closer or more distant than they actually are.

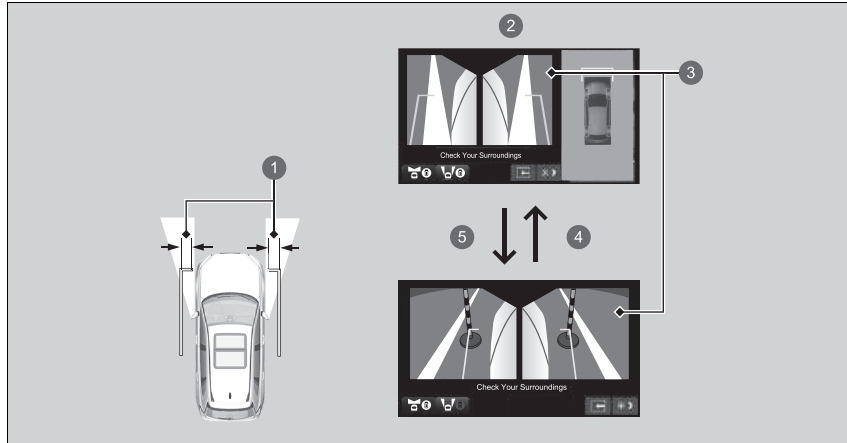
### ■ Checking the sides of your vehicle

The side view screens are convenient when you pull over at a curb or tollbooth, or slowly pass by oncoming vehicles on a narrow road.



- ① 40 cm (15.7 inches)
- ② Side View Screen
- ③ Side Views: The images from the side cameras
- ④  or 
- ⑤  or 

Approximate distance the projection lines indicate is 40 cm (15.7 inches) from the vehicle.

### ⌘ Checking the sides of your vehicle

When the door mirrors are folded, the side views cannot be displayed.

## Multi-View Camera Limitations

The system may not work properly under the following conditions.

Conditions		Solutions	
The projection line is not accurate.		Have your vehicle checked by a dealer.	
The images may not appear clearly when:	<ul style="list-style-type: none"> <li>You activate the system in bad weather (heavy rain, snow, fog, etc.) or in the dark.</li> <li>Camera temperatures are high.</li> <li>A sudden change between light and dark such as an entrance or exit of a tunnel.</li> <li>You drive into the sunlight (e.g., at dawn or dusk.)</li> <li>A camera lens is scratched.</li> </ul>	Do not use the multi-view camera system but rely only on visual confirmation until the conditions allow the system to work properly.	
	<ul style="list-style-type: none"> <li>A camera lens is covered with dirt, moisture, or debris.</li> <li>When water drops or insects get on the camera lens.</li> </ul>		Clean camera lenses with a soft cloth moisturised with water, mild detergent or glass cleaner.
	<ul style="list-style-type: none"> <li>The audio/information screen is dirty.</li> </ul>		Wipe off the screen using a soft dry cloth.
A camera angle is altered.	A camera or the area around the camera has been severely impacted.		
An error message is displayed while the multi-view camera system is in use.		Do not use the multi-view camera system and contact a dealer.	
The image does not come on the screen when you press the <b>CAMERA</b> button or select <b>Multi View Camera</b> on the audio/information screen and the vehicle is moving at 20 km/h (12 mph) or slower.			

## Honda Parking Pilot

Assists with parking and exit.

Cameras and sonar sensors will detect any parking spaces and set a route for parking in or pulling out of a space. The system will then help you park in or exit the space by adjusting your speed, moving the steering wheel, and changing the shift position.

## Honda Parking Pilot

### **WARNING**

**Honda Parking Pilot is not an automatic parking system.**

Like all assistance systems, Honda Parking Pilot has limitations.

Overreliance on this system may result in a collision.

If you encounter the following situations while using the system, stop the car or cancel system operation, then manually avoid the situation.

- When you are about to collide with an obstacle, pedestrian, or another vehicle.
- When you encounter curbs, bumps, or wheel stoppers that should not be driven over.
- When you are about to enter a “No Entry” area.

Just like when parking manually, always visually and directly check your surroundings.

The system can be used in the following situations:

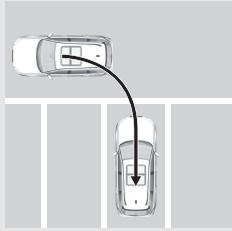
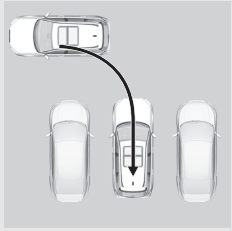
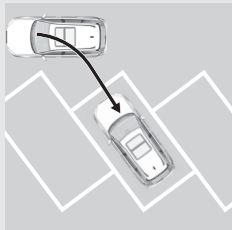
Parking patterns	Parking spaces with boundary lines	Parking spaces without boundary lines
Reverse parking		
Reverse angle parking*1		—

\*1: The parking space can be detected if there are three or more boundary lines and enough spaces to park two or more vehicles.

▶▶ Honda Parking Pilot

**⚠ WARNING**

**Do not use this system in unsuitable locations**

Do not use Honda Parking Pilot on slopes, irregularly shaped parking spaces, and other locations where it is not suited for use.

▶ **Unsuitable Locations for System Use**  
P. 629

During Honda Parking Pilot operation, you may hear a sound when stopping/starting the vehicle. This is normal.

For the front/side/rear cameras, refer to the following page.

▶ **Camera Locations and Images** P. 614

For directions on the proper handling of the sonar sensors, refer to the following page.

▶ **Sonar Sensors** P. 589

When the Drive Mode is in **TOW** mode, the Honda Parking Pilot will turn off.

▶ **Drive Mode Switch** P. 445

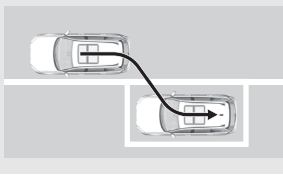
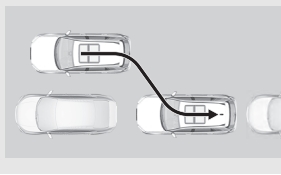
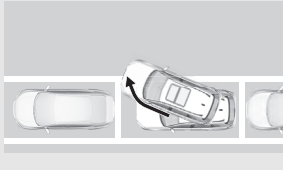
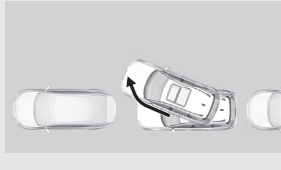
Parking patterns	Parking spaces with boundary lines	Parking spaces without boundary lines
Parallel parking		
Pulling out of parallel parking*1		

\*1: Limited to where there is a vehicles in front.

## ■ Unsuitable Locations for System Use

Honda Parking Pilot is not suitable for use in locations where the vehicle may become unable to move forward or backwards or slip easily or the parking space like the following.

- There is a slope.
- The area is hilly or uneven.
- The area is unpaved and made of sand, gravel, grass, etc.
- The area is snow-covered.
- The area is slippery due to snow, ice, etc.
- The lane is narrow.
- There is an obstacle in front of the vehicle.
- The parking space is curved.
- Nearby vehicles are parked outside of the lines.

Reverse parking

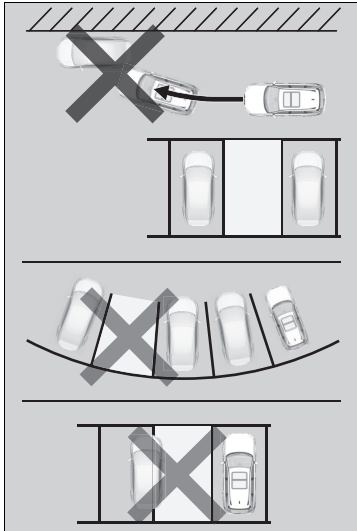

Parallel parking

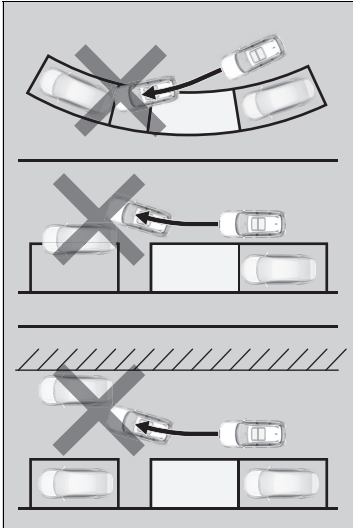

## ■ How to use Honda Parking Pilot

### ■ How to enter a parking space

You can use Honda Parking Pilot with parking spaces with boundary lines or similar guidelines, such as in the illustrations below.

You may not park properly if the parking spaces are too narrow or wide against the guidelines.

Reverse parking\*1

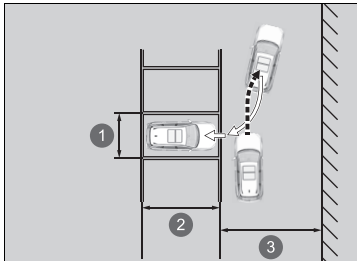

- ① About 2.5 m (8.2 ft.)
- ② Vehicle length + about 0.5 m (1.6 ft.) or more
- ③ Lane width 5.5 m (18 ft.) or more

\*1: If there are no boundary lines, the distance between the two other vehicles is about 3.2 m (10.5 ft.).

### ▶ How to use Honda Parking Pilot

## ⚠ WARNING

**Be careful not to get your hands caught in the steering wheel.**

The steering wheel will turn automatically.

Audio volume cannot be adjusted while Honda Parking Pilot is in use.

## Reverse angle parking

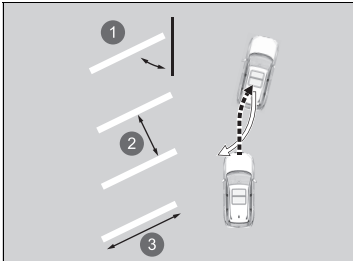

- ① About 60 degrees or 45 degrees
- ② About 2.5 m (8.2 ft.)
- ③ Vehicle length + about 0.5 m (1.6 ft.) or more

### Parallel Parking\*1

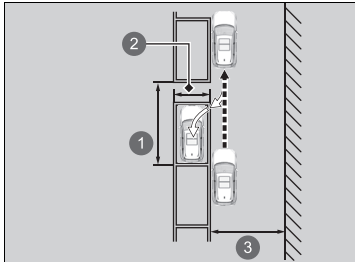

- ① Vehicle length + about 1.5 m (4.9 ft.) or more
- ② White lines about 2.5 m (8.2 ft.)
- ③ About 5.5 m (18 ft.) or more

\*1 : If there are no boundary lines, the distance between the other vehicles should be vehicle length + 1.5 m (4.9 ft.) or more.

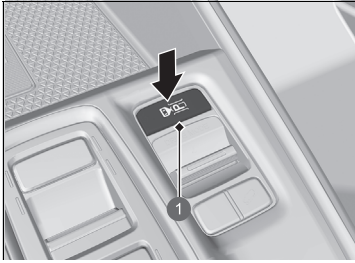

1 Honda Parking Pilot Switch

1. Press the Honda Parking Pilot switch and the Honda Parking Pilot mode will be displayed.

- ▶  (grey) will be displayed in the upper left of the screen.
- ▶ If the system is in pull out mode, you can choose parking mode by touching the **IN/OUT** icon.



- 1  (grey)
- 2 **IN/OUT** Icon

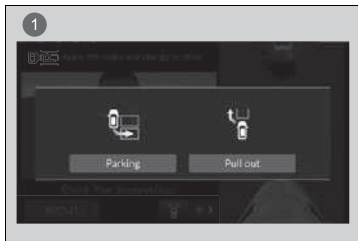

① Mode Change Display

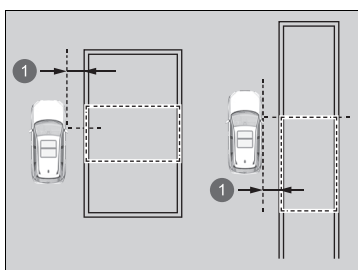

① About 1 m (3.3 ft.)

2. Move the vehicle close to the space where you want to park, and slowly advance to within 1 m (3.3 ft.) of the parking space until you are parallel to the parking space. Stop when the candidate parking space is outlined in green on the display.

- ▶ The system will beep when it detects a parking space.
- ▶ The detected parking space boundary (green) may be adjusted depending on the vehicle position or other condition.

▶▶ How to enter a parking space

Honda Parking Pilot cannot be used if the detected parking space is not shown.

Tips for detecting the target position

The parking space with boundary:

Stop so that the driver's seat is just beside the parking space.

The parking space without boundary:

Stop so that the driver's seat is behind the parking space.

When you select the parking space directly confirm the space of the area.

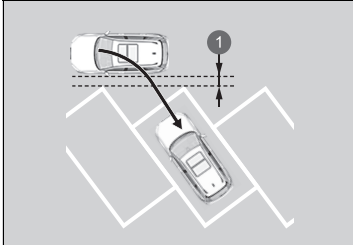

1 About 1 m (3.3 ft.)

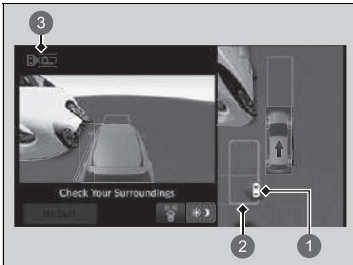

- 1 Parking Space (green)
- 2 Target Position (blue)
- 3  (grey)

3. While the vehicle is stopped, select the lines of any parking space (green) by touching the screen.
  - ▶ When the selection screen for reverse parking or parallel parking displays, select the applicable mode.
  - ▶ The selected lines of any parking space (green) will be the target position (blue).

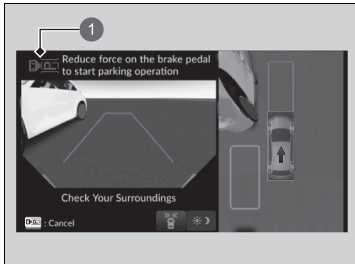
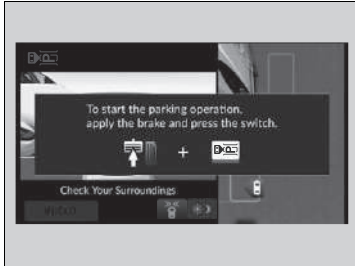

1  (blue)

4. Press the Honda Parking Pilot switch while depressing the brake pedal.
  - ▶ When in operation, the system will beep and  will blink in blue in the upper left of the display.
  - ▶ The shift position will change depending on the direction in which the vehicle is moving.
  
5. Check your surroundings, the route on the screen, and stopping position, then release the brake pedal.
  - ▶ The vehicle will start to move. Adjust your speed with the brake pedal if necessary.
  - ▶ When you have finished parking, the shift position will change to **P** and the parking brake will automatically engage.
  - ▶ **Parking operation is complete** message will display, then it will return to the previous screen.
  - ▶ Adjust the parking location or position if needed.
  - ▶ After parking, confirm the shift position is in **P**.

▶▶ How to enter a parking space

After the system begins to operate, if there is an obstacle in your path, stop the vehicle with the brake pedal, press the Honda Parking Pilot switch and stop operation.

After the vehicle moved close to the target position, it may be possible that the vehicle move again to adjust the vehicle position. Pay attention to the surroundings and stop the vehicle if needed.

You can stop the parking brake from automatically engaging after parking has finished.

▶▶ **Customized Features** P. 360

## ■ When pulling out from a parallel parking space

Honda Parking Pilot can be used if there is a vehicle in front of you at the following parking space.

Pull out

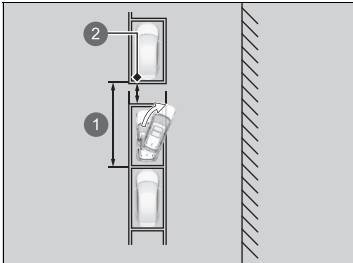

- ❶ Vehicle length + about 1.5 m (4.9 ft.) or more
- ❷ Distance of about 50 cm (20 inches) or more from other vehicles

▶▶ When pulling out from a parallel parking space

### ⚠ WARNING

**Be careful not to get your hands caught in the steering wheel.**

The steering wheel will turn automatically.

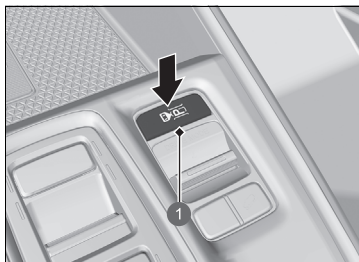

1 Honda Parking Pilot Switch

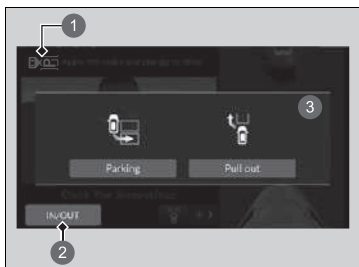

- 1  (grey)
- 2 **IN/OUT** Icon
- 3 Mode Change Display

1. Press the Honda Parking Pilot switch and the Honda Parking Pilot mode will be displayed.
  - ▶  (grey) will be displayed in the upper left of the screen.
  - ▶ If the system is in parking mode, you can choose pull out mode by touching the mode selector icon.
  - ▶ Depress the brake pedal following the directions on the screen and change the shift position to **R**.

▶▶ When pulling out from a parallel parking space

The pull out function cannot be used if someone has double parked in front of the vehicle.

The pull out function cannot be used if the space between your vehicle and the vehicles in front of or behind you is extremely small or if there is a person or obstacle in between them.

Even if the parking sensor detects a person or obstacle while the pull out function is in use, it will continue to operate.

If a moving vehicle approaches from the rear, depress the brake pedal and stop the vehicle.

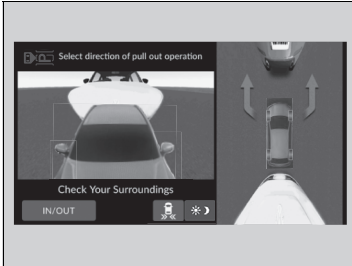

2. Tap and select the direction in which you will pull out on the screen with depressing the brake pedal.
3. Press the Honda Parking Pilot switch while depressing the brake pedal.
  - ▶ When in operation, the system will beep and **P.O.** will blink in blue in the upper left of the display.
  - ▶ The shift position will change depending on the direction in which the vehicle is moving.
4. With the brake pedal depressed, release the parking brake by pressing the parking brake switch then release the brake pedal.
  - ▶ The vehicle will begin to move. Check your surroundings and adjust your speed using the brake pedal.
  - ▶ Pay attention to the situation in the direction in which you will pull out.
  - ▶ Once you have arrived at the point where pull out assistance will end, **Apply the brake to complete pull out operation** will display on the screen.

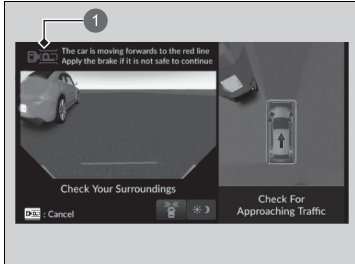

1  (blue)

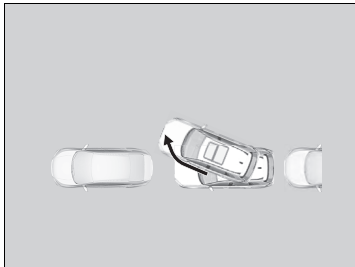

5. Follow the instructions and depress the brake pedal.
  - ▶ **Pull out operation is complete** will display in the upper left of the screen and assistance will end.
  - ▶ If the brake pedal is released, the vehicle will creep forward. Make sure the shift position and manually control the vehicle.



① Cancel Icon

### ■ Honda Parking Pilot shut off

In order to turn off Honda Parking Pilot after parking assistance has begun, depress the brake pedal to stop the vehicle, then press the Honda Parking Pilot switch.

Even if you touch the cancel icon, Honda Parking Pilot will not turn off.

When operation is cancelled, a warning will sound and a message saying **Parking operation cancelled/Pull out operation cancelled** will be shown on the screen.

Depress the brake pedal.

- ▶ The system will return to the previous screen. Since the vehicle is no longer being controlled by the system, it will begin to creep if the brake pedal is released. Make sure the shift position and manually control the vehicle.

If Honda Parking Pilot is shut off, it is not possible to resume operation. You must start again from the beginning or park the vehicle manually.

### ■ Examples of shut off conditions

- The driver changed the shift position to **P**.
- The parking brake was engaged.
- About five minutes has passed since operation began.
- Vehicle Stability Assist (VSA) was activated.
- VSA was set to OFF.
- Something unusual was detected.
- Low Speed Braking Control was activated.
- The Collision Mitigation Braking System (CMBS) was activated.
- The vehicle speed is too high.
- The system cannot operate due to a slope.
- The vehicle cannot get over uneven ground.
- There is an obstacle in the parking space and the system has determined there is not enough space after starting.
- When switched more than a certain amount of times.
- When you deviate from the route or a route cannot be generated.

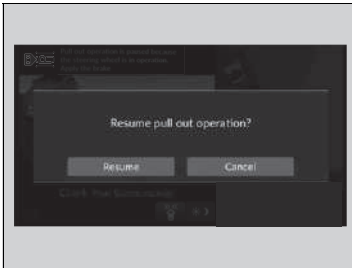

## ■ Pausing and restarting Honda Parking Pilot

If the system is paused, a beeper will sound, and a message will appear in the upper left of the screen.

Stop the vehicle by depressing the brake.

When assistance is able to be resumed, **Resume parking operation?/Resume pull out operation?** will be displayed on the screen. While the brake pedal is depressed, touch the **Resume** icon on the screen and assistance will continue. Release the brake pedal.

- ▶ The vehicle will begin to move. Check your surroundings and adjust your speed using the brake pedal.
- ▶ If you touch the cancel button while the brake pedal is depressed, assistance will end and **Parking operation cancelled/ Pull out operation cancelled.** will be displayed.  
Make sure the shift position and manually control the vehicle.
- ▶ If it is not possible to resume, **Resume** cannot be selected.

*Continued*



■ **Examples of pause conditions**

- The driver unfastened their seatbelt.
- A pedestrian or obstacle is detected.
- The driver depressed the accelerator.
- The driver turned the steering wheel.
- The driver changed the shift position to **D**, **R**, **N** or **B**.
- A door on the vehicle was opened (including the tailgate).

## ■ Error Messages

If the following condition occurred while using the system, there may be a problem with the system.

Stop the vehicle by depressing the brake pedal, change the shift position to **P** once and manually operate the vehicle after making sure the shift position.

- The screen is not displayed.
-  does not blink.
- The system does not beep.
-  is amber and an error message is displayed on the screen.

## ■ Honda Parking Pilot Conditions and Limitations

In the following situations, the target position may be misaligned or not detected at all, or the vehicle may not be able to park.

In addition, in the following situations that the route and turn-back position may not be generated properly, the system may detect obstacles or other things excessively and cancel the operation, or the vehicle may not be possible to stop before hitting an obstacle.

### ■ Environmental conditions

- The parking space boundary lines are faded or dirty.
- The parking space is outlined by rope, blocks, tile, etc.
- There is not much contrast between the pavement and parking space boundary lines.
- The parking space boundary lines are extremely thick, thin or short.
- Only one parking space boundary line can be seen.
- When the parking space is too wide or narrow.
- The parking area is too close or far from where you have stopped.

*Continued*

- The pavement of the parking area is not all one colour, or is uneven.
- There are shadows, paint, redrawn lines, etc. that look like parking space boundaries.
- The parking space boundaries are difficult to see, such as when parking at night or in dark indoor parking.
- Sunshine or lighting is reflected off of part or all of the pavement due to coating, etc.
- Sunlight, such as during sunrise or sunset, directly or indirectly enters the camera.
- It is difficult to see the boundary lines due to piled up snow, snow melting agents, etc.
- Shadows of adjacent objects (trees, buildings, guard rails vehicles, etc.) are parallel to the parking vehicle or parking space.
- There are holes, grooves, cliffs or protrusions.
- There are other vehicles with sonar sensors or other ultrasound-emitting objects close by.
- Driving in bad weather (rain, fog, snow, etc.).
- When similar shapes such as multiple window sashes are lined up in the building.
- Flaps, wheel stoppers, or other structures used in coin-operated parking lots.

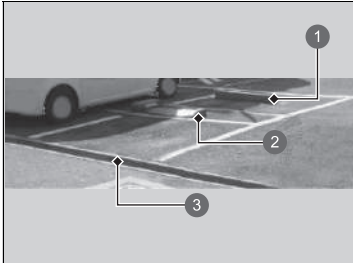

- ① Wheel Stopper
- ② Coin Park Flap
- ③ Different Level

#### ■ Vehicle conditions

- The vehicle is stopped at an angle to the parking space.
- The front of the camera is covered by dirt, fog, rain, mud, wet snow, seals, accessories, stickers, or film of the camera lens.
- The sonar sensors are dirty (covered with snow, ice, mud, etc.)
- The sonar sensors or damaged to facing the wrong direction.
- The vehicle is too hot or cold.
- The vehicle is tilted due to a heavy luggage in the luggage area or rear seats.
- An abnormal tyre or wheel condition (incorrect sizes, varied sizes or construction, improperly inflated, etc.).
- The vehicle is towing a trailer.

■ **Obstacle conditions**

- Obstacles that do not reflect sound waves well, such as people, snow, cloth, sponges, etc.
- Thin obstacles such as fences, chains, bicycles, sign posts, etc.
- Short or small obstacles.
- Curbs, parking curbs, level differences and other obstacles attached to the pavement.
- Obstacles immediately in front of the bumper.
- Obstacles such as walls that are not perpendicular to the ground.
- Moving objects or obstacles that suddenly enter the road.
- A sloped pillar or wall protruding from a high position.
- Specially-shaped obstacles, including other vehicles.
- The other vehicle is narrow.
- Ground clearance is high because the other vehicle is extremely low.
- Obstacles to the side of the vehicle.
- Obstacles, including other vehicles, too close or far from the vehicle.
- Your vehicle is approaching the obstacle at an angle.

## Fuel Information

### ■ Fuel recommendation

#### EN 228 standards petrol/gasohol fuel

**Unleaded premium petrol/gasohol up to E10 (90% petrol and 10% ethanol), research octane number 95 or higher**

Your vehicle is designed to operate on premium unleaded petrol with a research octane of 95 or higher.

If this octane grade is unavailable, regular unleaded petrol with a research octane of 91 or higher may be used temporarily.

The use of regular unleaded petrol can cause metallic knocking noises in the engine and will result in decreased engine performance. The long-term use of regular-grade petrol can lead to engine damage.

### ■ Fuel tank capacity: 46.5 L (10.2 Imp gal)

### ■ Engine cleaner

Fuel quality varies by region. Add genuine injector cleaner agent according to the time and distance instructions in the maintenance schedule.

Please use a genuine Honda injector cleaner agent. If not available, please use a PEA (polyetheramine) based cleaning agent instead.

Regular use of injector cleaner may be needed in countries or regions without a maintenance schedule. Consult your dealer for more information.

### » Fuel Information

#### NOTICE

Use of petrol that contains lead presents the following risks:

- Damage to the exhaust system including the catalytic converter
- Damage to the engine and fuel system
- Detrimental effects on the engine and other systems

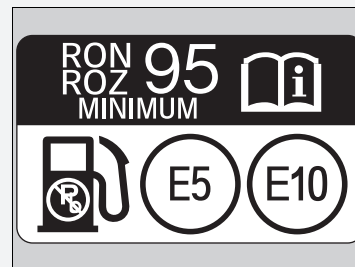

#### **Oxygenated Fuels**

Oxygenated fuels are blended with petrol and ethanol or ether compounds. Your vehicle is also designed to operate on oxygenated fuels containing up to 10% ethanol by volume and up to 22% ETBE by volume, based on the EN 228 standards. For more information, ask your dealer.

## How to Refuel



1 Fuel Fill Door Release Button

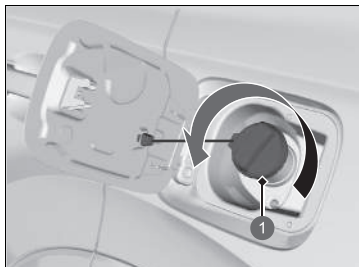

1 Cap

1. Stop your vehicle with the service station pump on the left side of the vehicle in the rear.
2. Put the transmission into **P**.
3. Turn the power system off.
4. Press the fuel fill door release button.
  - ▶ **Please wait** appears for a few seconds on the driver information interface.
5. When the message changes to **Ready**, the fuel fill door automatically opens.
  - ▶ You can now unscrew the fuel cap and start refueling.
6. Remove the fuel fill cap slowly. If you hear a release of air, wait until this stops, then turn the knob slowly to open the fuel fill cap.

### ▶▶ How to Refuel

#### **⚠ WARNING**

Petrol is highly flammable and explosive. You can be burned or seriously injured when handling fuel.

- Turn the power system off, and keep heat, sparks, and flames away.
- Handle fuel only outdoors.
- Wipe up spills immediately.

#### **⚠ CAUTION**

The filler nozzle automatically stops to leave space in the fuel tank so that fuel does not overflow as a result of changes in air temperature.

Do not continue to add fuel after the filler nozzle has automatically stopped. Additional fuel can exceed the full tank capacity and cause fuel to spill.

This vehicle has a pressurized fuel system. When the fuel vapor pressure inside the fuel tank is high, it takes about 15 seconds for the vehicle to vent the fuel tank. Once the pressure is vented, the driver information interface changes from **Please wait** to **Ready**.

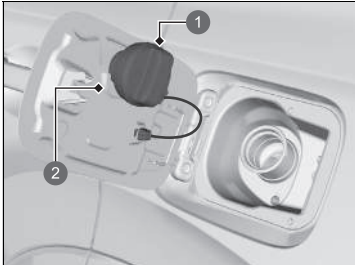

- ① Cap
- ② Holder

7. Place the fuel fill cap in the holder.
8. Insert the fuel filler nozzle fully.
  - ▶ When the tank is full, the filler nozzle will click off automatically. This leaves space in the fuel tank in case the fuel expands with a change in the temperature.
9. After filling, replace the fuel fill cap, tightening it until you hear it click at least once.
  - ▶ Shut the fuel fill door by hand.

#### How to Refuel

If the fuel fill door does not open after you press the button, even after the display changes to **Ready**, you can manually open the door.

#### ❏ If You Cannot Open the Fuel Fill Door P. 772

An internal valve automatically closes after 30 minutes from the moment you press the fuel fill door release button. When it does, do not continue to refuel as fuel may spill out.

When the fuel fill door automatically opens, a vent valve in the fuel system also opens to allow the air and the vapors being displaced by the fuel to escape. This valve automatically closes, however, if the refueling is not completed within 30 minutes. If this happens, reinstall the fuel cap, close the fuel fill door, and then follow these steps again to restart the system.

## Before Charging

Check the following items before you start charging your vehicle.

### Safety Checklist

- Make sure to use a dedicated and properly grounded circuit.
  - ▶ Have an electrician inspect the outlet you are using if you are unsure whether it meets these criteria.
- Make sure you plug the charging cable directly into the wall outlet dedicated to vehicle charging.
  - ▶ Do not use extension cords, adaptors, or multi-outlet plugs between the charging cable and the outlet.
- Make sure the charging cable is fully uncoiled before use.
- Make sure the control box, charging connector, and charging cable are free from any damage, including cracks or frays.
  - ▶ If you find any damage to the devices, stop using them.
- Make sure the charging connector and inlet are clean.
  - ▶ If you find any contamination or foreign object in the connector or inlet, consult a dealer.
- Make sure the charging charging connector and charging cable are dry.
  - ▶ Check that there is no water in the immediate area, and that your hands are dry.

Note: Outlet needs to be in good shape. Worn or damaged outlet will not make good contact with the plug. Ensure that the plug is fully inserted and does not come out of the outlet after installation. A loose connection will cause excessive heat build up within the plug and damage it.

### Charging

#### **WARNING**

Using a charging outlet that is powering other devices can cause a fire, seriously injuring you or others.

When using the charger, use a dedicated and properly grounded circuit. Consult an electrician if you are unsure whether your outlet meets these criteria.

#### **WARNING**

Charging the High Voltage battery under the following conditions is a potential source of electric shock and fire, which can result in serious injury or death:

- Charging the battery during an electric storm.
- Using the charging connector or charging cable near water or handling with wet hands.
- Using a charger, whose case is broken or cracked or whose cable is frayed or damaged.

Never charge the vehicle in any of the above situations.

## ▶ Charging

**⚠ WARNING**

Improper usage and handling of a charger can cause a fire, seriously injuring you or others.

- Always insert the plug fully into a properly rated and grounded the wall outlet.
- Plug the charging cable directly to the wall outlet. Do not use extension cords or multi-plug adapters.
- Prevent the vehicle charging connector from becoming contaminated. Clean if necessary.

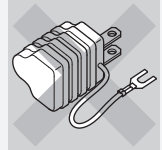
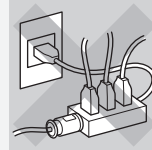
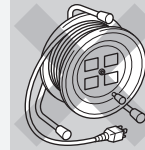

## Charge the High Voltage Battery Using a AC Charger

Charge the High Voltage battery by using the AC 230 volt charger.

Charging with	Suggested full charging time
AC 230 V (Incase of 32 amp)	2.5 hours

- Charging time varies depending on conditions such as the remaining battery level, the ambient temperature, and the charger being used.
- The suggested full charging time in this table indicates the hours it may likely take for the High Voltage battery to be fully charged.
- You can check the estimated full charging time on the gauge.

### ⚡ Charging

#### **WARNING**

Using a charger that is damaged or modified can cause electrical shock and fire, which can result in serious injury or death.

**Never disassemble or modify the charger. If the charger becomes damaged, stop using it and consult a dealer.**

#### **NOTICE**

Do not charge the vehicle with a vehicle cover on. It can cause a malfunction and damage the vehicle or charging components.

If the plug or connector are dirty or otherwise contaminated, carefully clean them with a dry clean cloth before use.

Do not wipe the metal part of the inlet and the charging connector. Also, if you are unable to clean the plug or connector, if the inlet is dirty, or if any are damaged or corroded, consult a dealer.

### ⌘ Charging

To avoid damage to the charger, take these precautions:

- Do not hit the charging connector components with a hard object or drop them on the ground.
- Do not pull, twist, tangle, drag or step on the charging cable.
- Do not use or store near any sources of heat.
- Do not expose to liquids or use harsh chemicals to clean.

If a blackout or other electrical interruption occurs during vehicle charging, the vehicle will automatically resume charging once power is restored.

When the battery warming system is activated, the battery may take longer to charge.

When the 12-volt battery is disconnected, vehicle charging is not possible. After reconnecting the 12-volt battery, turn the power system on, then turn it off. Confirm that charging is possible.

➤ **Turning on the Power** P. 428

While charging, sound may not be heard from the radio due to electromagnetic noise.

## ■ How to Charge (AC 230 V)

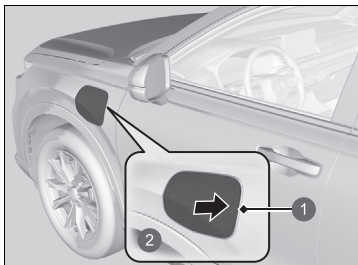

- ① Charge Lid
- ② Press

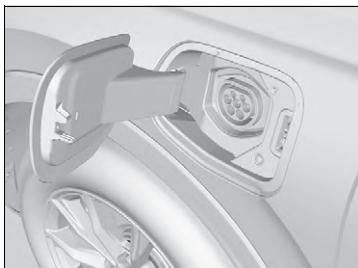

1. Put the transmission into **[P]** and turn the power system off.
  - ▶ Make sure the power system is off.
2. Unlock the driver's door.
  - ▶ The charge lid on the outer side of the vehicle will unlock.
3. Press and release the area indicated by the arrow to release the charge lid. You will hear a click and the lid will open slightly.
4. Manually pull the charge lid to a fully open position.

## ▣ How to Charge (AC 230 V)

Charging equipment with the following identifier is compatible with AC charging.

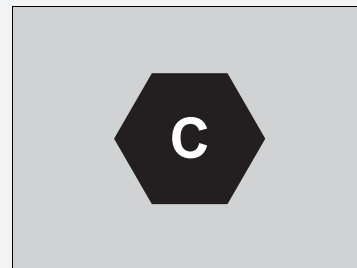

We recommend that you use a Honda genuine accessory AC 230 volt charger (sold separately). Ask a Honda dealer for more details on purchasing or using a charging cable.

If you carry a keyless remote, you can open the charge lid even if the doors are locked.

The charger requires a properly grounded and dedicated circuit that is protected by an overcurrent protection device (circuit breaker). We also recommend that a GFCI (ground-fault circuit interrupter) protected outlet be used to charge the vehicle. Follow the GFCI maker's installation instructions, or consult an electrician if you are not sure about installation requirements.

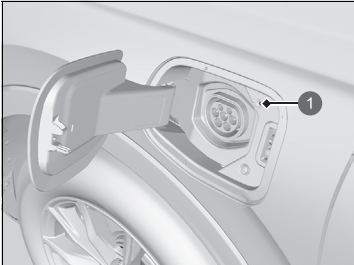

1 Charge Indicator

5. Align and insert the charging connector into the vehicle's inlet.

- ▶ The charge indicator (white) stops blinking, and change to sweep (blue) on when charging starts.

#### ⌘ How to Charge (AC 230 V)

Be sure to follow the instructions and safety precautions provided with the AC charging equipment.

After the charging connector has been connected, slowly pull it outward to make sure it cannot be pulled out and is firmly in place.

- ▶ Do not connect the charging connector to the inlet at an angle.
- ▶ Do not move the charging connector up and down when connecting it.

The High Voltage battery may not be charged even if the charging connector is properly connected to the vehicle's inlet when the charging timer is set.

- ▶ The High Voltage battery can be charged by disengaging and then reinserting the charging connector.

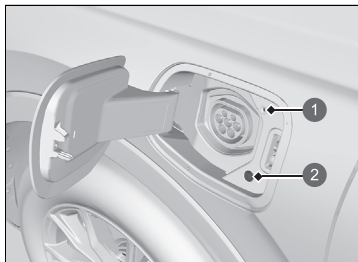

- 1 Charge Indicator
- 2 Unlock Button

### ■ When charging is completed

Press the unlock button, and wait without touching the charging connector until you hear the actuation sound of the motor running. After confirming that the actuation sound of the motor has stopped, disengage the charging connector.

The charge indicator (blue) stops sweep once charging is completed. After about 15 seconds, the charge indicator goes off.

### ▣ How to Charge (AC 230 V)

The charge speed slows down towards the completion of the battery charging.

If you unplug the charging connector from the inlet, charging cancels automatically.

The charging connector can be disengaged when the doors are unlocked.

If the doors are locked, the charging connector cannot be disengaged unless you carry the keyless remote.

If you do not disengage it within 30 seconds of unlocking the doors, the charging connector will automatically relock.

If the charging connector does not disengage, do not disengage it forcefully, and follow the procedures mentioned in the following page.

▣ **If You Cannot Disengage the Charging Connector** P. 774

## ■ Charge Indicator on the Vehicle Side

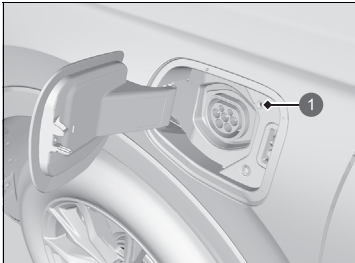

① Charge Indicator

Shows the High Voltage battery charging status.

Charge indicators status	Explanation
Blinks (white)	<ul style="list-style-type: none"> <li>• The charger is ready to charge the battery.</li> <li>• Charging is programmed to start using the timer.</li> <li>• The charging timer has been set.</li> </ul>
Sweep (blue)	<ul style="list-style-type: none"> <li>• The battery is being charged.</li> </ul>
Stays on (blue)	<ul style="list-style-type: none"> <li>• Charging is complete.</li> </ul>
Blinks once (blue)	<ul style="list-style-type: none"> <li>• The battery has been fully charged and systems such as the battery heating system have been activated.</li> </ul>
Blinks (red)	<ul style="list-style-type: none"> <li>• There is a problem with the charging system.                             <ul style="list-style-type: none"> <li>▶ Charging does not start.</li> </ul> </li> </ul>
Stays on (red)	<ul style="list-style-type: none"> <li>• The charging connector not inserted correctly.                             <ul style="list-style-type: none"> <li>▶ When connecting the charging cable to the vehicle, insert the connector until it hits the back so that it does not tilt.</li> </ul> </li> </ul>
Stays on (white)	<ul style="list-style-type: none"> <li>• The charger's stop button is pressed.</li> <li>• Charging is stopped by the charger timer.</li> </ul>

## Setting the Charging Wait Time Schedule

You can set a time period during which charging is disabled from the audio/information screen.

Charging will not start even if the charging connector is connected to the vehicle during the set time period.

▶ **Non-charging Schedule Setting** P. 353

### Settings on the Audio/Information Screen

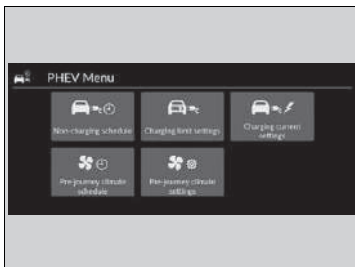

1. Select **PHEV Menu**, then select **Non-charging schedule**.

▶ The **Non-charging schedule** can not be set when you do not have the GPS after reconnecting the 12-volt battery. Move to an appropriate communication environment and set the schedule again.

2. Select **Schedule 1** or **Schedule 2**.

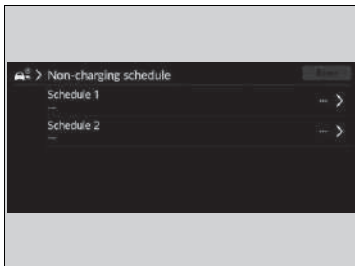

### ▶▶ Setting the Charging Wait Time Schedule

The charging wait timer schedule is only applicable to AC 230 V charging.

Even during the time set via **Non-charging schedule** Setting, the battery may not be sufficiently charged when any of the following systems are activated.

- Battery Warming System
- Pre air conditioner

The timer is enabled when the power mode is set to OFF.

### ▶▶ Settings on the Audio/Information Screen

**ON/OFF:** Selects whether the schedule is enabled or disabled.

**Time Period:** The battery will be charged except at the time during you have designated not to start.

**Day:** The battery will be charged except at the time during you have designated not to start.

**Location:** Select **Home** or **Anywhere**.

▶ **Home** may be selected when your vehicle is charged at near your home.

▶ **Anywhere** will be selected when the location of your home is not registered.

If the Home Location is not set in the navigation system, it will default to **Anywhere**.

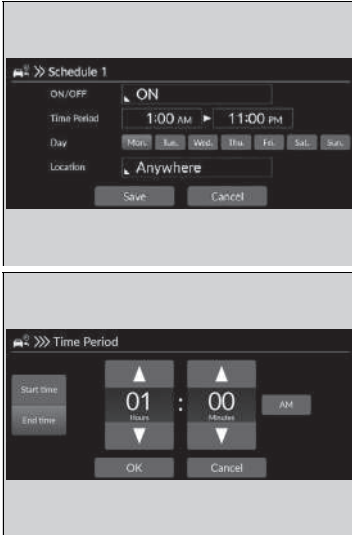

3. Select **ON** or **OFF**, then select settings for all items in order starting from the top.
4. Select **Save**.

## Maximum Charge Setting

You can use the audio/information screen to change the maximum charge limit of the high voltage battery when using AC 230 V charging equipment.

➤ **Charging Limit Settings** P. 354

If the charge station is located up on a hill, you do not need to fully charge the vehicle at the station. This is because additional electrical energy can be stored in the High Voltage battery as the motor acts an electric generator while going down a hill.

### Settings on the Audio/Information Screen

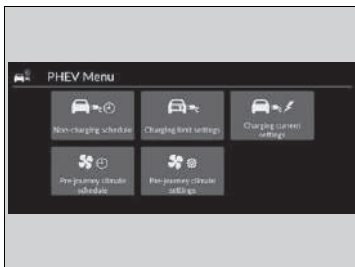

1. Select **PHEV Menu**.
2. Select **Charging limit settings**.

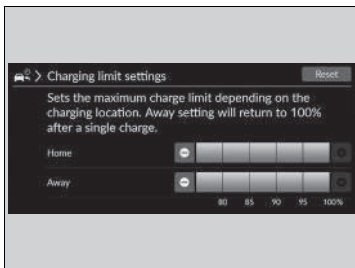

3. Select **Home** or **Away**.
  - ▶ You can set the maximum charge setting based on the location of the vehicle when charging.
    - Home:** The location set as home
    - Away:** Any other location
4. Choose your preferred charge amount.

### Settings on the Audio/Information Screen

To charge with the charge amount set in **Home**, you need to register the home position with navigation system.

If the Home Location is not set in the navigation system, you can customize **Away** setting only.

## Charging Current Settings

You can use the audio/information screen to change the charging current of the high voltage battery when using AC 230 V charging equipment.

- ▶ You can prevent the breaker from tripping when charging at home or while you are out.

📖 **Charging Current Settings** P. 354

### ■ Settings on the Audio/Information Screen

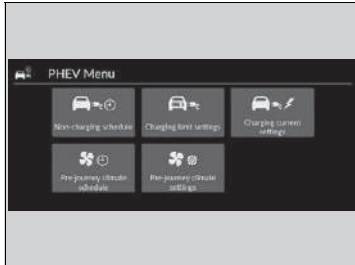

1. Select **PHEV Menu**.
2. Select **Charging current settings**.

**3. Select Home or Away.**

▶ You can set the charge current setting based on where you are charging your vehicle.

**4. Choose your preferred charge current.**

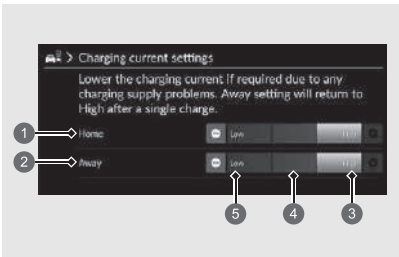
Audio/Information Screen	Charging with		Suggested Charging Time*1
	<b>High</b>	Incase of 32 amp	2.5 hours (full charge)
	<b>Between High and Low</b>	Incase of 19 amp	5 hours (full charge)
	<b>Low</b>	Incase of 6 amp	17 hours (full charge)

\*1: Charging time varies depending on conditions such as the remaining battery level, the ambient temperature, and the charger being used.

**1 Home:** The location set as home

▶ You need to register the home position with navigation system.

**2 Away:** Any other location

**3 High:** Maximum value (Up to 32 amp)

**4 Between High and Low:** Intermediate value between maximum value and 6 amp. (For example, if maximum value is 32 amp and minimum value is 6 amp, the Intermediate value would be 19 amp.)

**5 Low:** 6 amp

## High Voltage Battery

The High Voltage battery gradually discharges even if the vehicle is not in use. As a result, if your vehicle is parked for an extended period of time, the battery level may get low. Keeping your vehicle's battery level low can shorten the battery life. To maintain the battery while the vehicle is not in use, recharge the battery at least once every three months.

The High Voltage battery life can also be affected by ambient temperature. In particular, when it is cold outside, the vehicle's driving range on electric power can be reduced, and a longer battery charging time is required. In addition, parking in extremely hot or cold environments can accelerate battery drain.

To help extend the lifespan of the battery, it is recommended that you only fully charge the battery just before driving.

### High Voltage Battery

The High Voltage battery drains over time, and under some conditions, drains faster. When the battery life is shortened, this changes the vehicle's driving distance.

Be careful not to let the High Voltage battery drain too much. If the battery level becomes close to zero, it will make it impossible to turn the power system on.

High voltage batteries are accompanied by a label with the following information (The illustration is an example).

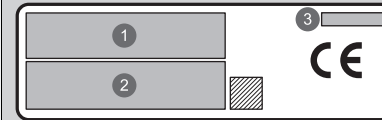

- ① Name and address of the manufacturer
- ② Name and address of the importer
- ③ Battery model and Batch number  
XXXXX##  
XXXXX: Battery model  
##: Batch number

## ■ Battery Warming System

When the outside temperature is low, this system uses electricity from the charging device or the High Voltage battery to prevent the temperature of the High Voltage battery from dropping, while also maintaining driving functionality and the ability to turn the power system on.

When the vehicle is left unplugged or has not been used for four days or longer while plugged in, this system uses electricity from the High Voltage battery.

This may cause the remaining battery charge to become low, and it may cause the battery to recharge.

### ▣ Battery Warming System

If the temperature of the High Voltage battery drops to -30°C or below, the power system will not start. If the warming system operates, wait for the High Voltage battery to warm up. If it does not operate, move the vehicle to a warmer location.

We recommend that you set **Non-charging schedule** Setting to **OFF** and plug in your vehicle when you will not use it for four days or longer.

▣ **Setting the Charging Wait Time Schedule**  
P. 662

Since the system does not operate when the 12-volt battery is removed, we do not recommend removing the 12-volt battery.

## Improving Fuel Economy and Reducing CO<sub>2</sub> Emissions

Achieving fuel economy and reducing CO<sub>2</sub> emissions is dependent on several factors, including driving conditions, load weight, idling time, driving habits, and vehicle condition. Depending on these and other factors, you may not achieve the rated fuel economy of this vehicle.

### Maintenance and Fuel Economy

You can optimize your fuel economy with proper maintenance of your vehicle. Follow the maintenance schedule and, if necessary, consult the service information provided for your vehicle.

On vehicles without service reminder system, follow the Maintenance schedule.

#### 📖 Maintenance Schedule\* P. 681

- Use engine oil with the viscosity recommended.
  - 📖 Recommended Engine Oil P. 692
- Maintain the specified tyre pressure.
- Do not load the vehicle with excess luggage.
- Keep your vehicle clean. A buildup of snow or mud on your vehicle's underside adds weight and increases wind resistance.

### 📖 Improving Fuel Economy and Reducing CO<sub>2</sub> Emissions

Direct calculation is the recommended method to determine actual fuel consumed while driving.

$$\begin{array}{l} \boxed{100} \times \boxed{\text{Litres of fuel}} \div \boxed{\text{Kilometres driven}} = \boxed{\text{L per 100 km}} \\ \boxed{\text{Miles driven}} \div \boxed{\text{Gallons of fuel}} = \boxed{\text{Miles per Gallon}} \end{array}$$

\* Not available on all models



# Maintenance

This chapter discusses basic maintenance.



## Before Performing Maintenance

Inspection and Maintenance .....	672
Safety When Performing Maintenance .....	673
Parts and Fluids Used in Maintenance	
Service .....	674
About Your Maintenance Service .....	675
<b>Service Reminder System*</b> .....	676
<b>Maintenance Schedule*</b> .....	681

## Maintenance Under the Bonnet

Maintenance Items Under the Bonnet ...	689
Opening the Bonnet .....	690
Recommended Engine Oil .....	692

Oil Check .....	694
Adding Engine Oil .....	695
Engine Coolant .....	696
High Voltage Battery System Coolant .....	699
Transmission Fluid .....	700
Brake Fluid .....	701
Refilling Window Washer Fluid .....	702
Fuel Filter .....	702
Resetting Oil Level Check Reminder .....	702
<b>Replacing Light Bulbs</b> .....	703
<b>Checking and Maintaining Wiper Blades</b> .....	706
<b>Checking and Maintaining Tyres</b>	
Checking Tyres .....	710

Wear Indicators .....	711
Tyre Service Life .....	711
Tyre and Wheel Replacement .....	712
Tyre Rotation .....	713
Snow Traction Devices .....	714
<b>12-Volt Battery</b> .....	715
<b>Remote Transmitter Care</b>	
Replacing the Remote Battery .....	721
<b>Climate Control System Maintenance</b> .....	723
<b>Cleaning</b>	
Interior Care .....	726
Exterior Care .....	729
<b>Accessories and Modifications</b> .....	733

\* Not available on all models

## Inspection and Maintenance

For your safety, perform all listed inspections and maintenance to keep your vehicle in good condition. If you become aware of any abnormality (noise, smell, insufficient brake fluid, oil residue on the ground, etc.), have your vehicle inspected by a dealer. Refer to the service information available for your vehicle/maintenance schedule in this owner's manual for detailed maintenance and inspection information.

➤ **Maintenance Schedule**\* P. 681

### Types of Inspection and Maintenance

#### ■ Routine inspections

Perform inspections before long distance trips, when washing the vehicle, or when refueling.

#### ■ Periodic inspections

- Check the brake fluid level monthly.
  - **Brake Fluid** P. 701
- Check the tyre pressure monthly. Examine the tread for wear and foreign objects.
  - **Checking and Maintaining Tyres** P. 710
- Check the operation of the exterior lights monthly.
  - **Replacing Light Bulbs** P. 703
- Check the condition of the wiper blades at least every six months.
  - **Checking and Maintaining Wiper Blades** P. 706

## Safety When Performing Maintenance

Some of the most important safety precautions are given here. However, we cannot warn you of every conceivable hazard that can arise in performing maintenance. Only you can decide whether you should perform a given task.

### Maintenance Safety

- To reduce the possibility of fire or explosion, keep cigarettes, sparks, and flames away from the 12-volt battery, all High Voltage system, and all fuel related parts.
- Never leave rags, towels, or other flammable objects under the bonnet.
  - ▶ Heat from the engine and exhaust can ignite them, causing a fire.
- To clean parts, use a commercially available degreaser or parts cleaner, not petrol.
- Wear eye protection and protective clothing when working with the 12-volt battery or compressed air.
- Engine exhaust contains carbon monoxide, which is poisonous and can kill you.
  - ▶ Only operate the engine if there is sufficient ventilation.

#### ⚠ Safety When Performing Maintenance

### ⚠ WARNING

Improperly maintaining this vehicle or failing to correct a problem before driving can cause a crash in which you can be seriously hurt or killed.

Always follow the inspection and maintenance recommendations and schedules in this owner's manual/service information available for your vehicle.

### ⚠ WARNING

Failure to properly follow maintenance instructions and precautions can cause you to be seriously hurt or killed.

Always follow the procedures and precautions in this owner's manual.

## ■ Vehicle Safety

- The vehicle must be in a stationary condition.
  - ▶ Make sure your vehicle is parked on level ground, the parking brake is set, and the power system is turned off.
- Make sure that the radiator fan is stopped before inspecting the engine compartment.
  - ▶ Depending on the vehicle condition, the radiator fan may operate even when the power mode is in VEHICLE OFF.
- Be aware that hot parts can burn you.
  - ▶ Make sure to let the power system including the engine and exhaust system cool thoroughly before touching vehicle parts.
- Be aware that moving parts can injure you.
  - ▶ Do not activate the power system unless instructed, and keep your hands and limbs away from moving parts. When the power mode is on, the engine can automatically start, or the radiator fan may start operating without the engine running.
- Do not touch the high-voltage battery and wiring (orange).

## Parts and Fluids Used in Maintenance Service

The use of Honda genuine parts and fluids is recommended when maintaining and servicing your vehicle. Honda genuine parts are manufactured according to the same high quality standards used in Honda vehicles.

### ▶▶ Parts and Fluids Used in Maintenance Service

#### **NOTICE**

Do not press the engine cover forcibly. This may damage the engine cover and component parts.

## About Your Maintenance Service

If the service reminder system is available in your vehicle, you are informed by the driver information interface when your vehicle's maintenance services are due. Refer to the service information available for your vehicle for an explanation of the service item codes that appear on the display.

📄 **Service Reminder System**\* P. 676

If the service reminder system is not available, follow the maintenance schedules in the service book\* that came with your vehicle.

If your vehicle is without the service book\*, follow the maintenance schedule in this owner's manual.

📄 **Maintenance Schedule**\* P. 681

### 📄 About Your Maintenance Service

#### Models with service reminder system

If you are planning to take your vehicle outside the service reminder system applied countries, consult a dealer for how to record your service reminder information and schedule your maintenance service under the conditions of that country.

\* Not available on all models

# Service Reminder System\*

Provides information of which service items are to be performed. Service items are represented by a code and icon. The system tells you when to take your vehicle to a dealer by days remaining.

When the next maintenance service timing is near, coming or passed, a warning icon will also appear on the driver information interface every time you set the power mode to ON.

## Service Reminder System\*

You can choose to have a corresponding warning message displayed with the warning icon on the driver information interface.

## ■ Displaying the Service Reminder Information

1. Set the power mode to ON.
2. Roll the right selector wheel until the service reminder information screen is displayed. The maintenance item(s) appears on the driver information interface along with maintenance items due soon.

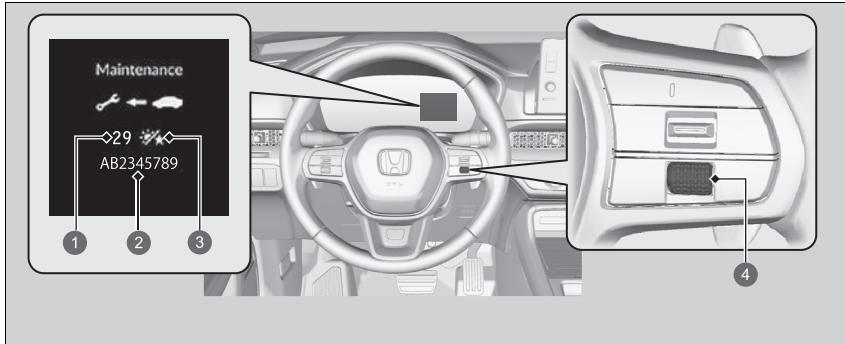





- 1 Remaining Days
- 2 Maintenance Item Code(s)
- 3 Day Icon
- 4 Right Selector Wheel

The system message indicator (i) comes on along with the service reminder information.

## ☒ Displaying the Service Reminder Information

Based on engine operating conditions and engine oil conditions, the system calculates the remaining days before the next service is to be performed.

## Warning Icons and Service Reminder Information on the Driver Information Interface

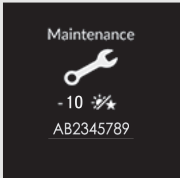
Warning Icon	Service Reminder Information	Explanation	Information
<p><b>Service Due Soon</b></p> 		<p>One or more of the service items are required in less than 30 days. The remaining days are estimated based on your driving conditions.</p>	<p>The remaining days will be counted down per day.</p>
<p><b>Service Due Now</b></p> 		<p>One or more of the service items are required in less than 10 days. The remaining days are estimated based on your driving conditions.</p>	<p>Have the indicated service performed as soon as possible.</p>
<p><b>Service Over Due</b></p> 		<p>The indicated maintenance service is still not done after the remaining time reaches 0.</p>	<p>Your vehicle has passed the service required point. Immediately have the service performed and make sure to reset the service reminder system.</p>

## ■ Service Reminder Items

Service items displayed on the driver information interface are in code and icon. For an explanation of the service reminder codes and icons, refer to the service information available for your vehicle.

## ■ Availability of the Service Reminder System

Even if the service reminder information appears on the driver information interface while roll the right selector wheel, this system is not available in some countries. Refer to the service information available for your vehicle, or ask a dealer if you can use the service reminder system.

## ▣ Availability of the Service Reminder System

If you are planning to take your vehicle outside the service reminder system applied countries, consult a dealer on how to record your service reminder information and schedule your maintenance service under the conditions of that country.

## ■ Resetting the Display

Reset the service reminder information display if you have performed the maintenance service.

1. Set the power mode to ON.
2. Roll the right selector wheel until the service reminder information screen is displayed.
3. Press and hold the right selector wheel for about 10 seconds to enter the reset mode.
4. Roll the right selector wheel to select a maintenance item to reset, or to select **All due items** (you can also select **Cancel** to end the process).
5. Press the right selector wheel to reset the selected item.
6. Repeat from step 3 for other items you wish to reset.

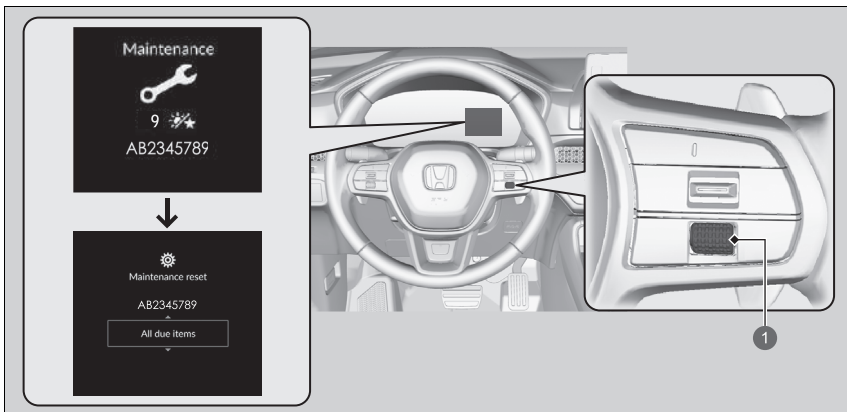

1 Right Selector Wheel

## ▶▶ Resetting the Display

### NOTICE

Failure to reset the service reminder information after a maintenance service results in the system showing incorrect maintenance intervals, which can lead to serious mechanical problems.

You can also reset the service reminder system information display using the audio/information screen.

▶ **How to Customize the Vehicle Settings**  
P. 368

The dealer will reset the service reminder information display after completing the required maintenance service. If someone other than a dealer performs maintenance service, reset the service reminder information display yourself.

## Maintenance Schedule\*

Maintenance information for your vehicle can be found with the service information for your vehicle (if available). If service information is not available, refer to the following maintenance schedules.

The maintenance schedule outlines the minimum required maintenance that you should perform to ensure the troublefree operation of your vehicle. Due to regional and climatic differences, some additional servicing may be required. Please consult your warranty booklet for a more detailed description.

Maintenance work should be performed by properly trained and equipped technicians. Your authorised dealer meets all of these requirements.

Except Ukrainian models

Service at the indicated distance or time - whichever comes first.	km x 1,000	20	40	60	80	100	120	140	160	180	200
	miles x 1,000	12.5	25.0	37.5	50.0	62.5	75.0	87.5	100.0	112.5	125.0
	months	12	24	36	48	60	72	84	96	108	120
Replace engine oil	Normal	Every 10,000 km (6,000 miles) or 1 year									
	Severe	Every 5,000 km (3,000 miles) or 6 months									
Replace engine oil filter	Normal	Every 20,000 km (12,000 miles) or 2 years									
	Severe	Every 10,000 km (6,000 miles) or 1 year									
Replace air cleaner element		Every 30,000 km (18,500 miles)									
Replace spark plugs		Every 100,000 km (62,000 miles)									
Replace engine coolant		At 200,000 km (124,000 miles) or 10 years, thereafter every 100,000 km (62,000 miles) or 5 years									
Add genuine injector cleaner* <sup>1</sup>		Every 10,000 km (6,000 miles) or 1 year									
Replace transmission fluid	Normal	Every 150,000 km (93,000 miles) or 6 years									
	Severe	Every 75,000 km (46,500 miles) or 3 years									

\*1: Regular use of injector cleaner is required for models designated for Honduras, Nicaragua, Gambia, Nigeria, Cape Verde, Peru, Djibouti, Guinea, Guatemala, Venezuela, Haiti, Togo, Equatorial Guinea, Afghanistan, Iraq, Liberia, Philippines, Sierra Leone, Dominica and Grand Cayman

Service at the indicated distance or time - whichever comes first.	km x 1,000	20	40	60	80	100	120	140	160	180	200
	miles x 1,000	12.5	25.0	37.5	50.0	62.5	75.0	87.5	100.0	112.5	125.0
	months	12	24	36	48	60	72	84	96	108	120
Replace dust and pollen filter		•	•	•	•	•	•	•	•	•	•
Inspect front and rear brakes		Every 10,000 km (6,000 miles) or 1 year									
Replace brake fluid		Every 3 years									
Replace fuel filter in tank	Normal	Every 210,000 km (130,000 miles)									
	Severe	Every 130,000 km (80,500 miles)* <sup>1</sup>									
Check expiration date for temporary tyre repair kit bottle		Every 1 year									
Rotate tyres (Check tyre inflation and condition at least once per month)		Every 10,000 km (6,000 miles)									
<b>Visually inspect the following items:</b>											
Driveshaft boots		Every 10,000 km (6,000 miles) or 1 year									
Tie rod ends, steering gearbox, and boots											
Suspension components											
Under body battery cover											
Brake hoses and lines (including ABS/VSA)		•	•	•	•	•	•	•	•	•	•
Exhaust system											
Fuel lines and connections											
All fluid levels and condition of fluid											

\*1: It is recommended that you replace the fuel filter if the fuel you are using is suspected to be contaminated with dust, etc. because the filter may be clogged sooner.

**Ukrainian models**

Service at the indicated distance or time - whichever comes first.	km X 1,000	15	30	45	60	75	90	105	120	135	150	165	180	195
	months	12	24	36	48	60	72	84	96	108	120	132	144	156
Replace engine oil	Normal	•	•	•	•	•	•	•	•	•	•	•	•	•
	Severe	Every 7,500 km or 6 months												
Replace engine oil filter	Normal	•	•	•	•	•	•	•	•	•	•	•	•	•
	Severe	Every 7,500 km or 6 months												
Replace air cleaner element		Every 30,000 km												
Replace spark plugs* <sup>1</sup>		Every 120,000 km												
Replace engine coolant		At 200,000 km or 10 years, thereafter every 100,000 km or 5 years												
Add genuine injector cleaner agent		Every 10,000 km or 1 year												
Replace transmission fluid		Every 80,000 km or 4 years												
Replace dust and pollen filter		•	•	•	•	•	•	•	•	•	•	•	•	•
Inspect front and rear brakes		•	•	•	•	•	•	•	•	•	•	•	•	•
Replace brake fluid		Every 3 years												
Replace fuel filter in tank	Normal	Every 210,000 km												
	Severe	Every 120,000 km* <sup>2</sup>												
Check expiration date for temporary tyre repair kit bottle		Every 1 year												
Rotate tyres (Check tyre inflation and condition at least once per month)		Every 15,000 km												

\*1: Inspect every 15,000 km

\*2: It is recommended that you replace the fuel filter if the fuel you are using is suspected to be contaminated with dust, etc. because the filter may be clogged sooner.

Service at the indicated distance or time - whichever comes first.	km X 1,000	15	30	45	60	75	90	105	120	135	150	165	180	195
	months	12	24	36	48	60	72	84	96	108	120	132	144	156
<b>Visually inspect the following items:</b>														
Driveshaft boots														
Tie rod ends, steering gearbox, and boots														
Suspension components														
Under body battery cover		•	•	•	•	•	•	•	•	•	•	•	•	•
Brake hoses and lines (including ABS/VSA)														
Exhaust system														
Fuel lines and connections														

## Severe Conditions

---

Follow the Severe Conditions Maintenance Schedule if you drive your car MAINLY under one or more of the following conditions:

- Driving less than 8 km (5 miles) per trip or, in freezing temperatures, driving less than 16 km (10 miles) per trip.
- Driving in extremely hot, over 35°C condition.
- Extensive idling or long periods of stop-and-go driving.
- Towing trailer, driving with a loaded car-top carrier, or driving in mountainous conditions.
- Driving on muddy, dusty, or de-iced roads.

NOTE: If you only OCCASIONALLY drive under “severe” conditions, you should follow the Normal Conditions Maintenance Schedule.

## Maintenance Record (on vehicles without separate service record)

Have your servicing dealer record all required maintenance below. Keep receipts for all work done on your vehicle.

Except Ukrainian models

Km or Month	Date	Sign or Stamp
<b>20,000 km</b> 12,500 Mi. (or 12 Mo.)		
<b>40,000 km</b> 25,000 Mi. (or 24 Mo.)		
<b>60,000 km</b> 37,500 Mi. (or 36 Mo.)		
<b>80,000 km</b> 50,000 Mi. (or 48 Mo.)		
<b>100,000 km</b> 62,500 Mi. (or 60 Mo.)		
<b>120,000 km</b> 75,000 Mi. (or 72 Mo.)		
<b>140,000 km</b> 87,500 Mi. (or 84 Mo.)		
<b>160,000 km</b> 100,000 Mi. (or 96 Mo.)		
<b>180,000 km</b> 112,500 Mi. (or 108 Mo.)		
<b>200,000 km</b> 125,000 Mi. (or 120 Mo.)		

Ukrainian models

Km or Month	Date	Sign or Stamp
<b>15,000 km</b> (or 12 Mo.)		
<b>30,000 km</b> (or 24 Mo.)		
<b>45,000 km</b> (or 36 Mo.)		
<b>60,000 km</b> (or 48 Mo.)		
<b>75,000 km</b> (or 60 Mo.)		
<b>90,000 km</b> (or 72 Mo.)		
<b>105,000 km</b> (or 84 Mo.)		
<b>120,000 km</b> (or 96 Mo.)		
<b>135,000 km</b> (or 108 Mo.)		
<b>150,000 km</b> (or 120 Mo.)		
<b>165,000 km</b> (or 132 Mo.)		
<b>180,000 km</b> (or 144 Mo.)		
<b>195,000 km</b> (or 156 Mo.)		

## Maintenance Items Under the Bonnet

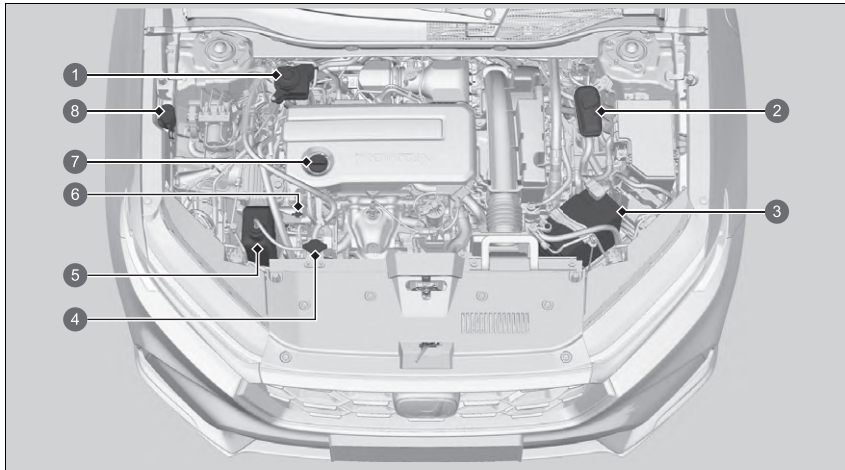

- ① Brake Fluid (Black Cap)
- ② High Voltage Battery System Coolant Reserve Tank
- ③ 12-Volt Battery
- ④ Radiator Cap
- ⑤ Engine Coolant Reserve Tank
- ⑥ Engine Oil Dipstick (Orange)
- ⑦ Engine Oil Fill Cap
- ⑧ Washer Fluid (Blue Cap)

## Opening the Bonnet



- 1 Bonnet Release Handle
- 2 Pull

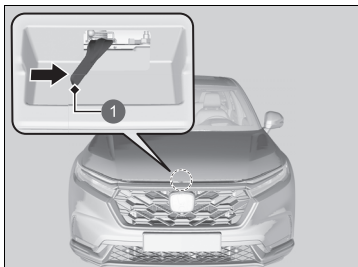

- 1 Lever

1. Park the vehicle on a level surface, and set the parking brake.
2. Pull the bonnet release handle under the driver's side lower outside corner of the dashboard.
  - The bonnet will pop up slightly.

### Opening the Bonnet

#### NOTICE

Do not open the bonnet when the wiper arms are raised. The bonnet will strike the wipers, resulting in possible damage to the bonnet and/or the wipers.

#### NOTICE

Do not press the engine cover forcibly. This may damage the engine cover and component parts.

When closing the bonnet, check that the bonnet is securely latched.

If the bonnet latch lever moves stiffly, or if you can open the bonnet without lifting the lever, the latch mechanism should be cleaned and lubricated.



4. Lift the bonnet up most of the way.
  - The hydraulic supports will lift it up the rest of the way and hold it up.

When closing, lower it to approximately 30 cm (12 inches), then press down firmly with your hands.

## Recommended Engine Oil

Use a genuine engine oil or another commercial engine oil of suitable type and viscosity (for the ambient temperature) as shown in the image that follows.

Oil is a major contributor to your engine's performance and longevity. If you drive the vehicle with insufficient or deteriorated oil, the engine may fail or be damaged.

Except Cypriot, Israeli, Moldova, and Ukrainian models

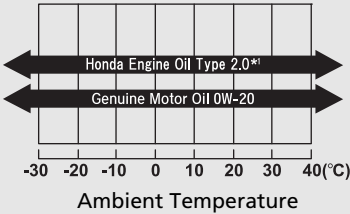
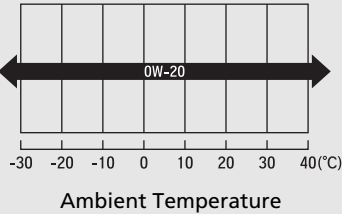
Genuine Engine Oil	Commercial Engine Oil
<ul style="list-style-type: none"> <li>• Honda Engine Oil Type 2.0*1</li> <li>• Honda Genuine Motor Oil</li> </ul> 	<ul style="list-style-type: none"> <li>• ACEA C5</li> </ul> 

\*1: Formulated to improve fuel economy.

### Recommended Engine Oil

Engine Oil Additives

You cannot use Engine Oil Additives.

Cypriot, Israeli, Moldova, and Ukrainian models

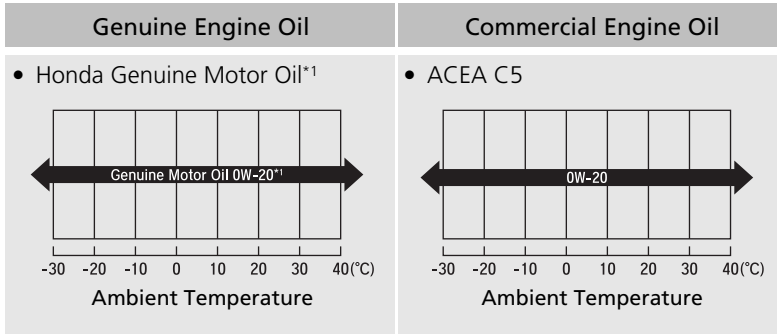

\*1: Formulated to improve fuel economy.

## Oil Check

We recommend that you check the engine oil level every time you refuel or you charge the High Voltage battery. Park the vehicle on level ground.

Turn off the power system. You can check the oil level without the engine having run beforehand. If the engine has been running, wait approximately three minutes before you check the oil.

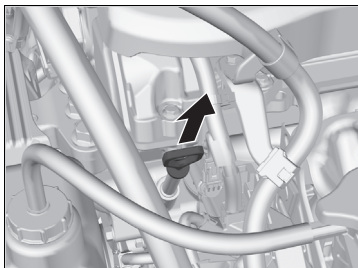

1. Remove the dipstick (orange).
2. Wipe the dipstick with a clean cloth or paper towel.
3. Insert the dipstick back all the way into its hole.

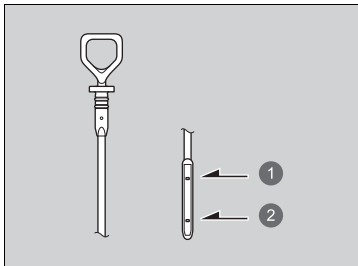

- 1 Upper Mark
- 2 Lower Mark

4. Remove the dipstick again, and check the level. It should be between the upper and lower marks. Add oil if necessary.
5. Reset the Oil Level Check Reminder.

► **Resetting Oil Level Check Reminder**  
P. 702

### Oil Check

If the oil level is near or below the lower mark, slowly add oil, being careful not to overfill.

The amount of oil consumed depends on how the vehicle is driven and the climatic and road conditions encountered. The rate of oil consumption can be up to 1 litre per 1,000 km/625 miles. Consumption is likely to be higher when the engine is new.

If your vehicle is not equipped with a Service Reminder System, the Oil Level Check Reminder should also be reset after changing the oil.

► **Resetting Oil Level Check Reminder** P. 702

## Adding Engine Oil

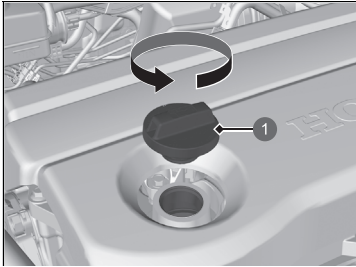

1 Engine Oil Fill Cap

1. Unscrew and remove the engine oil fill cap.
2. Add oil slowly.
3. Reinstall the engine oil fill cap, and tighten it securely.
4. Wait for three minutes and recheck the engine oil dipstick.
5. Reset the Oil Level Check Reminder.

### ➤ Resetting Oil Level Check Reminder

P. 702

### ▶▶ Adding Engine Oil

#### NOTICE

Do not fill the engine oil above the upper mark. Overfilling the engine oil may result in leaks and engine damage.

If any oil spills, wipe it away immediately. Spilled oil may damage the engine compartment components.

Use a neutral detergent to remove it if it spills on the engine cover. Do not use organic solvents such as brake cleaner.

If your vehicle is not equipped with a Service Reminder System, the Oil Level Check Reminder should also be reset after changing the oil.

### ➤ Resetting Oil Level Check Reminder P. 702

## Engine Coolant

### Specified coolant: Honda All Season Antifreeze/Coolant Type 2

This coolant is premixed with 50% antifreeze and 50% water. Do not add any straight antifreeze or water.

We recommend you check the engine coolant level every time you refuel. Check the reserve tank first. If it is completely empty, also check the coolant level in the radiator. Add the engine coolant accordingly.

### Reserve Tank

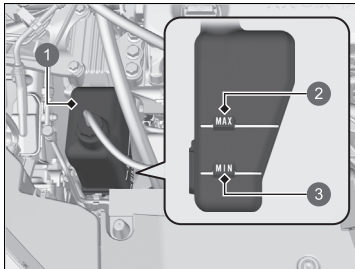

- ① Reserve Tank
- ② **MAX**
- ③ **MIN**

1. **Make sure the engine and radiator are cool.**
2. Check the amount of coolant in the reserve tank.
  - If the coolant level is below the **MIN** mark, add the specified coolant until it reaches the **MAX** mark.

### Engine Coolant

## ⚠ WARNING

Removing the radiator cap while the engine is hot can cause the coolant to spray out, seriously scalding you.

Always let the engine and radiator cool down before removing the radiator cap.

### NOTICE

If temperatures consistently below  $-30^{\circ}\text{C}$  are expected, the coolant mixture should be changed to a higher concentration. Consult your Honda dealer for details about a suitable coolant mixture.

If Honda antifreeze/coolant is not available, you may use another major brand of non-silicate coolant as a temporary replacement. Check that it is a high quality coolant recommended for aluminium engines. Continued use of any non-Honda coolant can result in corrosion, causing the cooling system to malfunction or fail. Have the cooling system flushed and refilled with Honda antifreeze/coolant as soon as possible.

Do not add rust inhibitors or other additives to your vehicle's cooling system. They may not be compatible with the coolant or with the engine components.

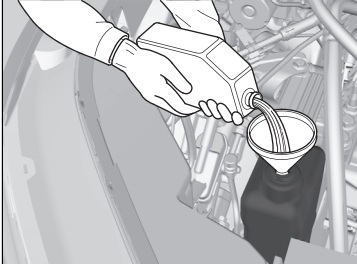

3. Inspect the cooling system for leaks.

## ■ Radiator

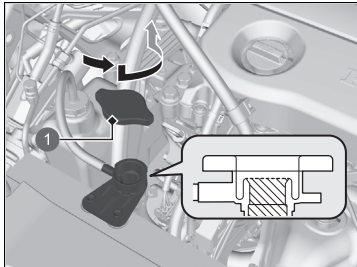

① Radiator Cap

1. **Make sure the engine and radiator are cool.**
2. Turn the radiator cap 1/8th turn anti-clockwise and relieve any pressure in the cooling system.
3. Push down and turn the radiator cap anti-clockwise to remove it.
4. The coolant level should be up to the base of the filler neck. Add coolant if it is low.
5. Put the radiator cap back on, and tighten it fully.

## ■ Radiator Cap



- Never open when hot.
- Hot coolant will scald you.
- Relief pressure valve begins to open at 108 kPa.

## ►► Radiator

### NOTICE

Pour the fluid slowly and carefully so you do not spill any. Clean up any spills immediately; they can damage components in the engine compartment.

## High Voltage Battery System Coolant

Coolant is used to reduce the temperature of the high voltage battery, power control unit and related parts. When checking the coolant level, make sure to follow the procedures listed below. If the coolant level is below the **MIN** mark, have your vehicle inspected by a dealer.

### High Voltage Battery System Coolant Reserve Tank

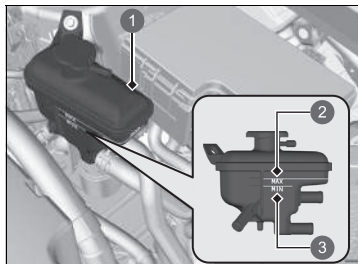

- ① Reserve Tank
- ② **MAX**
- ③ **MIN**

1. Check the coolant level in the tank.
2. If the coolant level has dropped below the **MIN** level, have your vehicle serviced at a dealer.
  - Only a properly trained technician can refill the coolant and check the system for leaks.

### High Voltage Battery System Coolant Reserve Tank Cap



- Never open when hot.
- Hot coolant will scald you.
- Relief pressure valve begins to open at 49 kPa.

#### High Voltage Battery System Coolant

Do not add rust inhibitors or other additives to your vehicle's cooling system. They may not be compatible with the coolant or with the motor components.

## Transmission Fluid

### Specified fluid: Honda HEVF-Type 1

Have a dealer check the fluid level and replace if necessary. Follow your vehicle's maintenance service timing of when to change transmission fluid.

➤ **Maintenance Schedule\*** P. 681

Do not attempt to check or change the transmission fluid yourself.

### ▶▶ Transmission Fluid

#### NOTICE

**Do not mix Honda HEVF-Type 1 with other transmission fluids.**

Using a transmission fluid other than Honda HEVF-Type 1 may adversely affect the operation and durability of your vehicle's transmission, and damage the transmission.

Any damage caused by using a transmission fluid that is not equivalent to Honda HEVF-Type 1 is not covered by Honda's new vehicle limited warranty.

## Brake Fluid

**Specified fluid: Brake Fluid with DOT 3 or DOT 4**

### ■ Checking the Brake Fluid

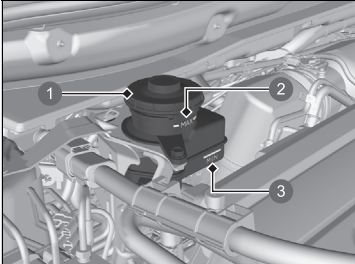

- ❶ Reserve Tank
- ❷ **MAX**
- ❸ **MIN**

The fluid level should be between the **MIN** and **MAX** marks on the side of the reserve tank.

#### » Brake Fluid

##### NOTICE

Brake fluid marked DOT 5 is not compatible with your vehicle's braking system and can cause extensive damage.

We recommend using a genuine product.

If the brake fluid level is at or below the **MIN** mark, have a dealer inspect the vehicle for leaks or worn brake pads as soon as possible.

## Refilling Window Washer Fluid

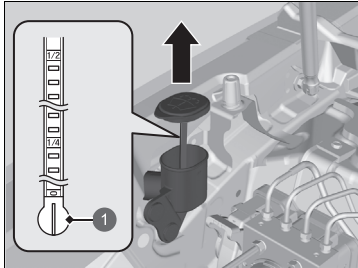

① Level Gauge

Check the amount of window washer fluid using the washer fluid level gauge on the cap.

If the level is low, fill the washer reservoir.

Pour the washer fluid carefully. Do not overflow the reservoir.

## Fuel Filter

Replace fuel filter according to the time and distance recommendations in the maintenance schedule.

Have a qualified technician change the fuel filter. Fuel in the system can spray out and create a hazard if all fuel line connections are not handled correctly.

## Resetting Oil Level Check Reminder

Reset the Oil Check Reminder if you have checked the oil level.

You can reset the Oil Check Reminder using the audio/information screen.

📄 **How to Customize the Vehicle Settings** P. 368

### ►► Refilling Window Washer Fluid

#### NOTICE

Do not use engine antifreeze or a vinegar/water solution in the windscreen washer reservoir. Antifreeze can damage your vehicle's paint. A vinegar/water solution can damage the windscreen washer pump.

Use only commercially available windscreen washer fluid.

Avoid prolonged use of hard water to prevent lime scale buildup.

### ►► Fuel Filter

#### Models with service reminder system

The fuel filter should be replaced according to the service reminder indication.

## Headlights

---

Headlights are LED type. Have an authorised Honda dealer inspect and replace the light assembly.

## Front Turn Signal Lights, Position/Daytime Running Lights

---

Front turn signal lights, position/daytime running lights are LED type. Have an authorised Honda dealer inspect and replace the light assembly.

## Active Cornering Lights\*

---

Active cornering lights are LED type. Have an authorised Honda dealer inspect and replace the light assembly.

## Side Turn Signal/Emergency Indicator Lights

---

Door mirror side turn lights are LED type. Have an authorised Honda dealer inspect and replace the light assembly.

## Brake Lights, Taillights, Rear Side Marker Lights, and Rear Turn Signal Lights

---

Brake lights, taillights, rear side marker lights, and rear turn signal lights are LED type. Have an authorised Honda dealer inspect and replace the light assembly.

\* Not available on all models

### Headlights

The headlight aim is set by the factory, and does not need to be adjusted. However, if you regularly carry heavy items in the luggage area or tow a trailer, have the aiming readjusted at a dealer or by a qualified technician.

## **Taillights, Rear Fog Light, and Back-Up Lights**

---

Taillights, rear fog light, and back-up lights are LED type. Have an authorised Honda dealer inspect and replace the light assembly.

## **Rear Licence Plate Light**

---

Rear licence plate light is LED type. Have an authorised Honda dealer inspect and replace the light assembly.

## **High-Mount Brake Light**

---

High-mount brake light is LED type. Have an authorised Honda dealer inspect and replace the light assembly.

## Other Light Bulbs

### ■ Vanity Mirror Light Bulbs

When replacing, use the following bulbs.

**Vanity Mirror Light: 2 W**

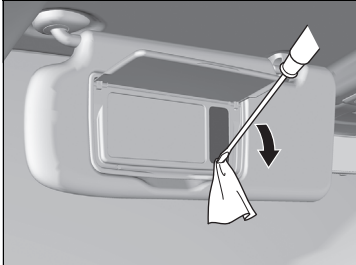

1. Pry on the edge of the cover using a flat-tip screwdriver to remove the cover.
  - ▶ Wrap the flat-tip screwdriver with a cloth to prevent scratches.

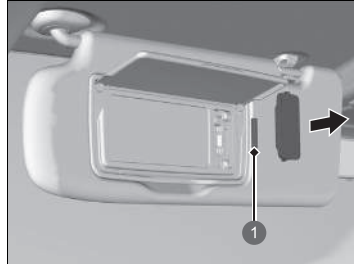

- 1 Bulb
2. Remove the old bulb and insert a new bulb.

## Checking Wiper Blades

If the wiper blade rubber has deteriorated, it will leave streaks and become noisy, and the hard surfaces of the blade may scratch the window glass.

## Changing the Front Wiper Blade

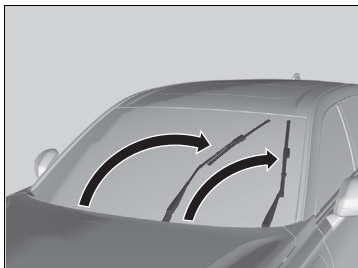

1. Set the power mode to ON, then to VEHICLE OFF.
2. Within 10 seconds of setting the power mode to VEHICLE OFF, hold the wiper switch in the **MIST** position for more than two seconds.
  - ▶ Both wiper arms are set to the maintenance position as shown in the image.
3. Lift both wiper arms.

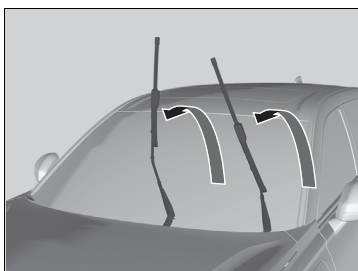

### Changing the Front Wiper Blade

#### NOTICE

**When lifting the wiper arms, always follow the instructions to move them into the maintenance position.**

The wiper arms may be damaged if they are moved manually.

#### NOTICE

Avoid dropping the wiper arm onto the windshield, as it may damage the wiper arm and/or the windshield.

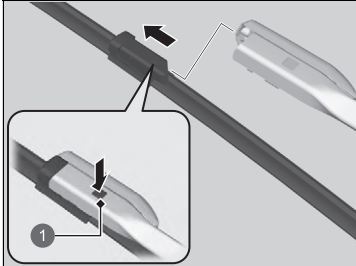

1 Tab

4. Depress the lock tab, then slide the wiper blade off the wiper arm.
5. Slide the new wiper blade onto the wiper arm until it clicks into place.
6. Lower both wiper arms.
7. Set the power mode to ON, then set the wiper switch to the **MIST** position once.
  - ▶ The wiper arms return to the standard position.

## Changing the Rear Wiper Blade Rubber

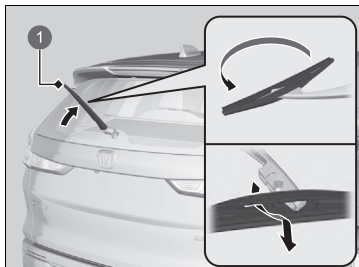

1 Wiper Arm

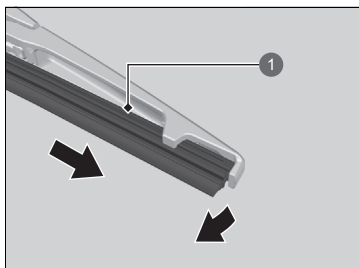

1 Blade

1. Raise the wiper arm off.
2. Pivot the bottom end of the wiper blade up until it comes off from the wiper arm.

3. Slide the blade out of the wiper.

### ▶▶ Changing the Rear Wiper Blade Rubber

#### NOTICE

Avoid dropping the wiper arm, as it may damage the rear window.

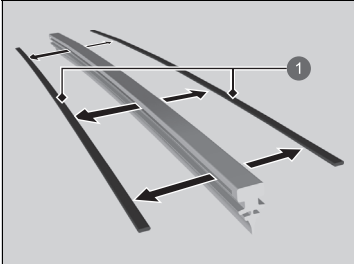

① Retainer

4. Remove the retainers from wiper blade and mount to a new rubber blade.

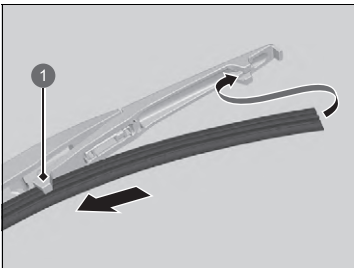

① Holder

5. Slide the new wiper blade onto the holder.  
▶ Make sure it is engaged correctly, then install the wiper blade assembly onto the wiper arm.

## Checking Tyres

To safely operate your vehicle, your tyres must be of the proper type and size, in good condition with adequate tread, and properly inflated.

### ■ Inflation guidelines

Properly inflated tyres provide the best combination of handling, tread life, and comfort. Refer to the driver's doorjamb label for the specified pressure.

Underinflated tyres wear unevenly, adversely affect handling and fuel economy, and are more likely to fail from overheating.

Overinflated tyres make your vehicle ride harshly, are more prone to road hazards, and wear unevenly.

Every day before you drive, look at each of the tyres. If one looks lower than the others, check the pressure with a tyre gauge.

At least once a month or before long trips, use a gauge to measure the pressure in all tyres. Even tyres in good condition can lose 10–20 kPa (0.1–0.2 bar, 1–2 psi) per month.

### ■ Inspection guidelines

Every time you check inflation, also examine the tyres and valve stems.

Look for:

- Bumps or bulges on the side or in the tread. Replace the tyre if you find any cuts, splits, or cracks in the side of the tyre. Replace it if you see fabric or cord.
- Remove any foreign objects and inspect for air leaks.
- Uneven tread wear. Have a dealer check the wheel alignment.
- Excessive tread wear.
  - **Wear Indicators** P. 711
- Cracks or other damage around valve stem.

### 🔧 Checking Tyres

## ⚠️ WARNING

Using tyres that are excessively worn or improperly inflated can cause a crash in which you can be seriously hurt or killed.

Follow all instructions in this owner's manual regarding tyre inflation and maintenance.

Measure the air pressure when tyres are cold. This means the vehicle has been parked for at least three hours, or driven less than 1.6 km (1 mile). If necessary, add or release air until the specified pressure is reached.

If checked when hot, tyre pressure can be as much as 30–40 kPa (0.3–0.4 bar, 4–6 psi) higher than if checked when cold.

Whenever tyre pressure is adjusted, you must calibrate the deflation warning system.

➤ **Deflation Warning System** P. 469

## Wear Indicators

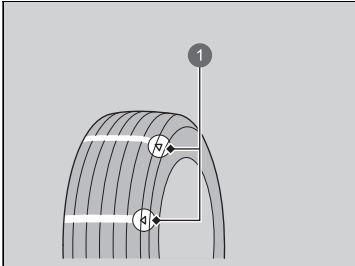

1 Example of a Wear Indicator mark

The groove where the wear indicator is located is about 1.6 mm (about 1/16 inch) shallower than elsewhere on the tyre. If the tread has worn so that the indicator is exposed, replace the tyre.

**Worn out tyres have poor traction on wet roads.**

## Tyre Service Life

The life of your tyres is dependent on many factors, including driving habits, road conditions, vehicle loading, inflation pressure, maintenance history, speed, and environmental conditions (even when the tyres are not in use).

In addition to regular inspections and inflation pressure maintenance, it is recommended that you have annual inspections performed once the tyres reach five years old. All tyres should be removed from service after 10 years from the date of manufacture, regardless of their condition or state of wear.

### ☒ Checking Tyres

Have a dealer check the tyres if you feel a consistent vibration while driving. New tyres and any that have been removed and reinstalled should be properly balanced.

## Tyre and Wheel Replacement

Replace your tyres with radials of the same size, load range, speed rating, and maximum cold tyre pressure rating (as shown on the tyre's sidewall). Using tyres of a different size or construction can cause certain vehicle systems such as the ABS and Vehicle Stability Assist (VSA) system to work incorrectly.

It is best to replace all four tyres at the same time. If that isn't possible, replace the front or rear tyres in pairs.

Make sure that the wheel's specifications match those of the original wheels.

### ▶▶ Tyre and Wheel Replacement

#### **WARNING**

Installing improper tyres on your vehicle can affect handling and stability. This can cause a crash in which you can be seriously hurt or killed.

Always use the size and type of tyres recommended in the tyre information label on your vehicle.

## Tyre Rotation

Rotating tyres according to the maintenance schedule helps to distribute wear more evenly and increase tyre life.

### ■ Tyres without rotation marks

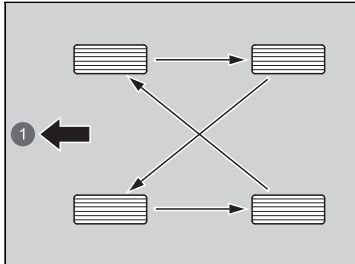

Rotate the tyres as shown here.

1 Front

### ■ Tyres with rotation marks

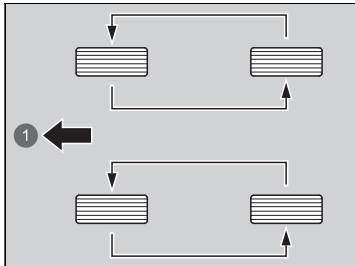

Rotate the tyres as shown here.

1 Front

### ► Tyre Rotation

Tyres with directional tread patterns should only be rotated front to back (not from one side to the other). Directional tyres should be mounted with the rotation indication mark facing forward, as shown below.

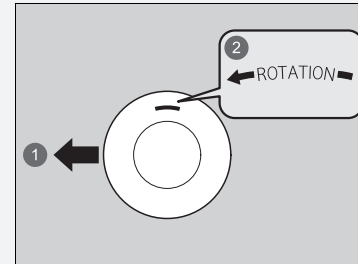

1 Front

2 Rotation Mark

When the tyres are rotated, make sure the air pressures are checked.

Whenever tyres are rotated, you must calibrate the deflation warning system.

► **Deflation Warning System** P. 469

## Snow Traction Devices

If driving on snowy or frozen roads, mount winter tyres, or tyre chains; reduce speed; and maintain sufficient distance between vehicles when driving.

Be particularly careful when operating the steering wheel or brakes to prevent skidding.

Use tyre chains, winter tyres, or all season tyres when necessary or according to the law.

When mounting, refer to the following points.

For winter tyres:

- Select the size and load ranges that are the same as the original tyres.
- Mount the tyres to all four wheels.

For tyre chains:

- Consult a dealer before purchasing any type of chains for your vehicle.
- Install them on the front tyres only.
- Because your vehicle has limited tyre clearance, we strongly recommend using the chains listed below:

Original Tyre Size*1	Chain Type
<b>235/60R18</b>	<b>RUD-matic classic 4716134</b>
<b>235/55R19</b>	<b>RUD-matic classic V 19642</b>

\*1: Original tyre size is mentioned on the tyre information label on the driver's doorjamb.

- Follow the chain manufacturer's instruction when installing. Mount them as tightly as you can.
- Check that the chains do not touch the brake lines or suspension.
- Drive slowly.

### ► Snow Traction Devices

## WARNING

**Using the wrong chains, or not properly installing chains, can damage the brake lines and cause a crash in which you can be seriously injured or killed.**

**Follow all instructions in this owner's manual regarding the selection and use of tyre chains.**

### NOTICE

Traction devices that are the wrong size or improperly installed can damage your vehicle's brake lines, suspension, body, and wheels. Stop driving if they are hitting any part of the vehicle.

According to the EU legislation for tyres, when winter tyres are used, it is necessary to affix a sticker with the allowable max. speed of the winter tyres clearly in the field of view of the driver, if the designed max. speed of vehicle is higher than the allowed max. speed of winter tyre. A sticker is obtainable from your tyre dealer. If you have any question, consult a dealer.

When tyre chains are mounted, follow the chain manufacturer's instructions regarding vehicle operational limits.

Use tyre chains only in an emergency or when they are legally required for driving through a certain area.

Use greater caution when driving with tyre chains on snow or ice. They may have less-predictable handling than good winter tyres without chains.

If your vehicle is equipped with summer tyres, be aware that these tyres are not designed for winter driving conditions. For more information, contact a dealer.

## Checking the 12-Volt Battery

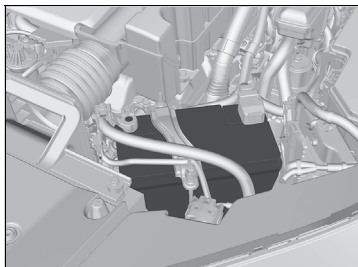

The condition of the battery is monitored by a sensor located on the negative terminal of the battery. If there is a problem with this sensor, the driver information interface will display a warning message. If this happens, have your vehicle inspected by a dealer.

Check the battery terminals for corrosion monthly.

If your vehicle's battery is disconnected or goes dead:

- The audio system is disabled.
  - ➔ **Reactivating the audio system** P. 291

### Right-hand Drive Type

- The immobilizer system needs to be reset.
  - ➔ **Immobilizer System Indicator** P. 127

### 12-Volt Battery

#### **⚠ WARNING**

The battery gives off explosive hydrogen gas during normal operation.

A spark or open flame can cause the battery to explode with enough force to kill or seriously hurt you.

Keep all sparks, open flames, and smoking materials away from the battery.

Wear protective clothing and a face shield, or have a skilled technician do any battery maintenance.

#### **⚠ WARNING**

The battery contains sulfuric acid (electrolyte) which is highly corrosive and poisonous.

Getting electrolyte in your eyes or on your skin can cause serious burns. Wear protective clothing and eye protection when working on or near the battery.

Swallowing electrolyte can cause fatal poisoning if immediate action is not taken.

**KEEP OUT OF THE REACH OF CHILDREN**

## 12-Volt Battery

### Emergency Procedures

Eyes: Flush with water from a cup or other container for at least 15 minutes. (Water under pressure can damage the eye.) Call a physician immediately.

Skin: Remove contaminated clothing. Flush the skin with large quantities of water. Call a physician immediately.

Swallowing: Drink water or milk. Call a physician immediately.

When you find corrosion, clean the battery terminals by applying a baking powder and water solution. Clean the terminals with a damp towel. Cloth/towel dry the battery. Coat the terminals with grease to help prevent future corrosion.

When replacing the battery, the replacement must be of the same specifications. Consult a dealer for more information.

The Vehicle Stability Assist (VSA) system, brake system (Amber), Adaptive Cruise Control (ACC) with Low Speed Follow, low tyre pressure/deflation warning system, Collision Mitigation Braking System (CMBS), Road Departure Mitigation, and safety support indicators may come on in amber along with a message in the gauge when you set the power mode to ON after reconnecting the 12-volt battery. Drive a short distance at more than 20 km/h (12 mph). Each indicator should go off. If any do not, have your vehicle checked by a dealer.

## Charging the 12-Volt Battery

---

Disconnect both battery cables to prevent damaging your vehicle's electrical system. Always disconnect the negative (-) cable first, and reconnect it last.

## Replacing the 12-Volt Battery

When you remove and replace the 12-volt battery, always follow the maintenance safety and the warnings for when checking the battery to prevent potential hazards.

➤ **Maintenance Safety** P. 673

➤ **Checking the 12-Volt Battery** P. 715

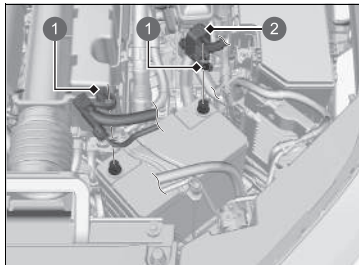

- 1 Nut
- 2 Cover

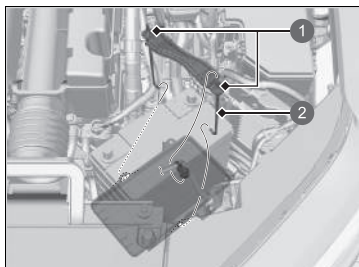

- 1 Nut
- 2 Stay

### ▶▶ Replacing the 12-Volt Battery

#### NOTICE

An improperly disposed of battery can be harmful to the environment and human health. Always confirm local regulations for battery disposal.

This symbol on the battery means that this product must not be treated as household waste.



To install a new battery, reverse this procedure.

Always disconnect the negative (-) cable first, and reconnect it last.

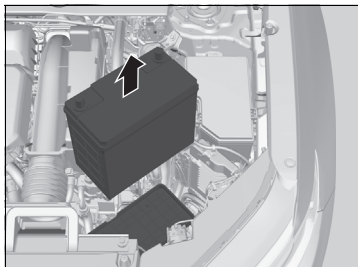

6. Take out the battery carefully.

## Battery Label



### ▶▶ Battery Label

#### **DANGER**

- Keep flames and sparks away from the battery. The battery produces explosive gas that can cause an explosion.
- Wear eye protection and rubber gloves when handling the battery to avoid risk of burns or loss of eyesight if exposed to battery electrolyte.
- Do not allow children to handle the battery, under any circumstance. Ensure that anyone handling the battery has a proper understanding of the hazards and correct handling procedures involved.
- Handle battery electrolyte with extreme care, as it contains dilute sulfuric acid. Exposure to eyes or skin can cause burns or loss of eyesight.
- Read this manual carefully, and understand it before handling the battery. Failure to do so can cause personal injury and damage to the vehicle.
- Do not use the battery if the level of electrolyte is at or below the recommended level. Using the battery with low electrolyte can cause it to explode, causing serious injury.

## Replacing the Remote Battery

If the indicator does not come on when the button is pressed, replace the battery.

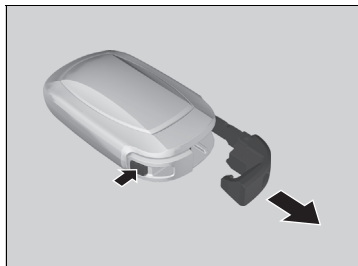

**Battery type: Manganese dioxide  
Lithium battery CR2032**

1. Remove the built-in key.
  - ▶ Wrap the key grip with a cloth to prevent scratching the remote key.
  - ▶ Remove carefully to avoid losing the buttons.
2. Remove the upper half of the cover by carefully prying on the slot with key grip.



### Replacing the Remote Battery

#### **⚠ ⚠ WARNING**

##### **CHEMICAL BURN HAZARD**

The battery that powers the remote transmitter can cause severe internal burns and can even lead to death if swallowed. Keep new and used batteries away from children.

If you suspect that a child has swallowed the battery, seek medical attention immediately.

**CAUTION:** Danger of explosion if battery is incorrectly replaced. Replace only with the same or equivalent type.

**CAUTION:** Do not exposed to excessive heat such as sunshine, fire or the like, that can result in an explosion or the leakage of flammable liquid or gas during use, storage or transportation.

**CAUTION:** Do not dispose of a battery into fire or a hot oven, or give mechanically crushing or cutting of a battery, that can result in an explosion.

**CAUTION:** Do not subjected to extremely low air pressure at high altitude that may result in an explosion or the leakage of flammable liquid or gas.

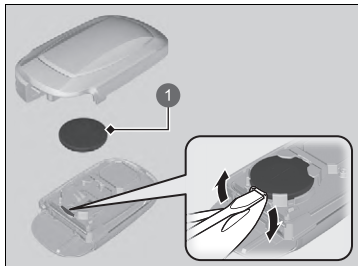

1 Battery

3. Remove the battery by prying on the edge with flat-tip screwdriver. Make sure to replace the battery with the correct polarity.  
▶ Wrap a flat-tip screwdriver with a cloth to prevent scratching the remote key.

## Button Battery Information



Product Name: Coin Primary lithium battery  
Model Number: CR2032  
Made in Indonesia  
Weight: 2.8g Capacity: 225mAh Chemistry: Lithium  
Useable extinguishing agent: Alcohol-resistant foam & dry sand  
Critical raw materials present in the battery in a concentration of more than 0.1% weight by weight: 0.07g  
Minimum average duration: 17520h(2years)  
Non-rechargeable  
Manufacturer Information:  
Panasonic Energy Co., Ltd.  
Trade name: Panasonic  
Postal address:1-1 Matsushita-cho, Moriguchi-city, Osaka, 570-8511, Japan

\* Not available on all models

### ▶▶ Replacing the Remote Battery

A warning mark is located adjacent to the button battery\*.

#### NOTICE

An improperly disposed of battery can damage the environment. Always confirm local regulations for battery disposal.

The following symbol means that this product must not be treated as household waste.



Replacement batteries are commercially available or at a dealer.

## Air Conditioning

For proper and safe operation of the climate control system, the refrigerant system should only be served by a qualified technician.

Never repair or replace the air conditioning evaporator (cooling coil) with one removed from a used or salvaged vehicle.

The climate control system in this vehicle contains fluorinated greenhouse gases.

### Climate Control System Maintenance

#### NOTICE

Vented refrigerant is harmful to the environment. To avoid refrigerant from venting, never replace the evaporator with one removed from a used or salvaged vehicle.

Refrigerant in your vehicle's air conditioning system is flammable and can be ignited during servicing if proper procedures are not followed.

The air conditioner label is found under the bonnet:

➤ **Safety Labels** P. 114

➤ **Specifications** P. 780

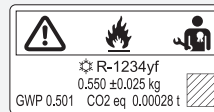

 : Caution

 : Flammable Refrigerant

 : Requires a qualified technician to service

 : Air Conditioning System

## Dust and Pollen Filter

### ■ When to Replace the Dust and Pollen Filter

Replace the dust and pollen filter according to your vehicle's recommended maintenance schedule. It is recommended to replace the filter even sooner if the vehicle has been driven in a dusty environment.

➤ **Maintenance Schedule\*** P. 681

### ■ How to Replace the Dust and Pollen Filter

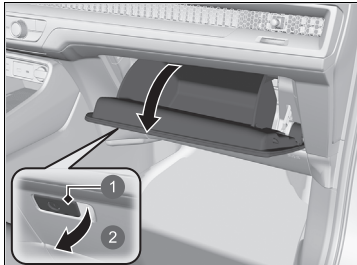

1. Open the glove box.

- 1 Handle
- 2 Pull

### ➤ Dust and Pollen Filter

If the airflow from the climate control system deteriorates noticeably, and the windows fog up easily, the filter may need to be replaced.

The dust and pollen filter collects pollen, dust, and other debris in the air.

If you are not sure how to replace the dust and pollen filter, have it replaced by a dealer.

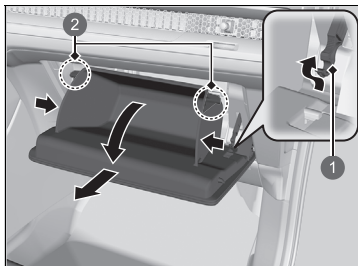

2. Push the stopper on the passenger's side of the glove box to detach it from the glove box.
3. Disengage the two tabs by pushing on each side panel.
4. Remove the glove box.

- 1 Stopper
- 2 Tab

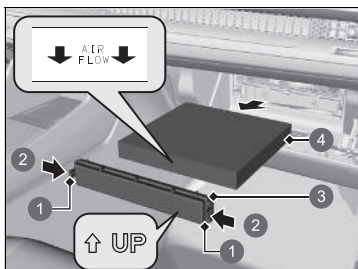

5. Push in the tabs on the corners of the filter case cover, and remove it.
6. Remove the filter from the case.
7. Install a new filter in the case.
  - Put the **AIR FLOW** arrow directed side down.

- 1 Tab
- 2 Push
- 3 Cover
- 4 Dust and Pollen Filter

## Interior Care

Use a vacuum cleaner to remove dust before using a cloth.

Use a damp cloth with a mixture of mild detergent and warm water to remove dirt.

Use a clean cloth to remove detergent residue.

### Cleaning Seat Belts

Use a soft brush with a mixture of mild soap and warm water to clean the seat belts.

Let the belts air dry. Wipe the loops of the seat belt anchorages using a clean cloth.

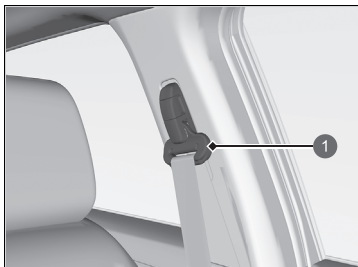

1 Loop

### Cleaning the Window

Wipe using a glass cleaner.

#### Interior Care

Do not spill liquids inside the vehicle. Electrical devices and systems may malfunction if liquids are splashed on them.

Do not use silicone-based sprays on electrical devices such as audio devices and switches. Doing so may cause the items to malfunction or cause a fire inside the vehicle.

If a silicone-based spray is inadvertently used on electrical devices, consult a dealer.

Depending on their composition, chemicals and liquid aromatics may cause discolouration, wrinkles, and cracking to resin-based parts and textiles. Do not use alkali solvents or organic solvents such as benzene or petrol.

After using chemicals, make sure to gently wipe them away using a dry cloth.

Do not place used cloths on top of resin-based parts or textiles for long periods of time without washing.

Be careful not to spill a liquid type air freshener.

#### Cleaning the Window

Wires are mounted to the inside of the rear window. Wipe along the same direction as the wires with a soft cloth so as not to damage them.

Be careful not to spill fluids, such as water or glass cleaner, on or around the cover of the electrical components around the rearview mirror.

## Floor Mats

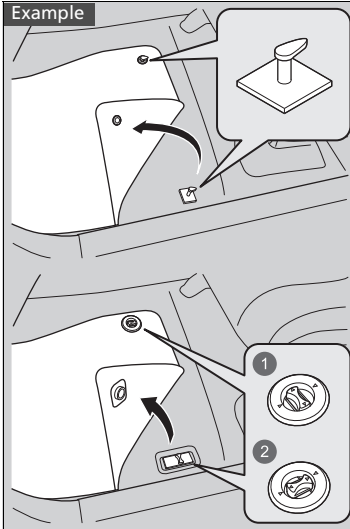

- 1 Unlock
- 2 Lock

The driver's floor mat hooks over floor anchors, which keep the mat from sliding forward.

**Do not put any additional floor mats on top of the anchored mat.**

### ⌘ Floor Mats

If you use any floor mats that were not originally provided with your vehicle, make sure they are designed for your specific vehicle, fit correctly, and are securely anchored by the floor anchors. Position any rear seat floor mats properly. If not properly positioned, the floor mats can interfere with the front seat functions.

Continued

## ■ Maintaining Genuine Leather

To properly clean leather:

1. Use a vacuum or soft dry cloth first to remove any dirt or dust.
2. Clean the leather with a soft cloth dampened with a solution comprised of 90% water and 10% neutral soap.
3. Wipe away any soap residue with a clean damp cloth.
4. Wipe away residual water and allow leather to air dry in the shade.

## ▣ Maintaining Genuine Leather

It is important to clean or wipe away dirt or dust as soon as possible. Spills can soak into leather, resulting in stains. Dirt or dust can cause abrasions in the leather. In addition, please note that some dark coloured clothing can rub onto the leather seats, resulting in discolouration or stains.

## Exterior Care

Dust off the vehicle body after you drive. Regularly inspect your vehicle for scratches on painted surfaces. A scratch on a painted surface can result in body rust. If you find a scratch, promptly repair it.

### ■ Washing the Vehicle

Wash the vehicle regularly. Wash more frequently when driving in the following conditions:

- If driving on roads with road salt.
- If driving in coastal areas.
- If tar, soot, bird droppings, insects, or tree sap is stuck to painted surfaces.

### ▶ Washing the Vehicle

Do not spray water into the air intake vents. It can cause a malfunction.

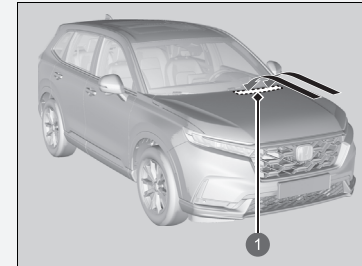

#### ① Air Intake Vents

Lock the doors when washing the vehicle. Do not spray water onto the charge lid directly. A high-pressure spray may cause it to open.

If you need to lift the wiper arms away from the windscreen, first set the wiper arms to the maintenance position.

#### ▶ Changing the Front Wiper Blade P. 706

If water and any chemicals are on the brakes when your vehicle is being washed, drive a short distance and apply the brakes several times before parking. Parking while brakes are wet may cause them to be stuck by rust.

*Continued*

## ■ Using an Automated Car Wash

- Make sure to follow the instructions indicated on the automated car wash.
- Fold in the door mirrors.
- For models equipped with automatic intermittent wipers, turn the wipers off.

## ■ Using High Pressure Cleaners

- Keep sufficient distance between the cleaning nozzle and the vehicle body.
- Take particular care around the windows. Standing too close may cause water to enter the vehicle interior.
- Do not spray high pressure water directly into the engine compartment. Instead, use low pressure water and a mild detergent.
- Do not spray water directly onto the camera or the area around it. Water may enter the lens and cause the camera to malfunction.

## ■ Applying Wax

A good coat of automotive body wax helps to protect your vehicle's paint from the elements. Wax will wear off over time and expose your vehicle's paint to the elements, so reapply as necessary.

## ■ Maintaining the Bumpers and Other Resin-Coated Parts

If you get petrol, oil, engine coolant, or battery fluid on resin-coated parts, they may stain or the coating may peel. Promptly wipe it away using a soft cloth and clean water.

## »» Using an Automated Car Wash

When using an automated car wash that pulls the vehicle through with a conveyor, make sure the transmission is in **N** position.

❗ **If you want to keep the transmission in **N** position (car wash mode)** P. 438

## »» Applying Wax

### NOTICE

Chemical solvents and strong cleaners can damage the paint, metal, and plastic on your vehicle. Wipe away spills immediately.

## »» Maintaining the Bumpers and Other Resin-Coated Parts

Ask a dealer about the correct coating material when you want to repair the painted surface of the parts made of resin.

## ■ Cleaning the Window

Wipe using a glass cleaner.

## ■ Maintaining Aluminium Wheels

Aluminium is susceptible to deterioration caused by salt and other road contaminants. When necessary, as early as possible use a sponge and mild detergent to wipe away these contaminants. Do not use a stiff brush or harsh chemicals (including some commercial wheel cleaners). These can damage the protective finish on aluminium alloy wheels, resulting in corrosion. Depending on the type of finish, the wheels also may lose their lustre or appear burnished. To avoid water stains, wipe the wheels dry with a cloth while they are still wet.

## ■ Fogged Exterior Light Lenses

The inside lenses of exterior lights (headlights, brake lights, etc.) may fog temporarily if you have driven in the rain, or after the vehicle has been run through a car wash. Dew condensation also may build up inside the lenses when there is a significant enough difference between the ambient and inside lens temperatures (similar to vehicle windows fogging up in rainy conditions). These conditions are natural processes, not structural design problems in the exterior lights.

Lens design characteristics may result in moisture developing on the light lens frame surfaces. This also is not a malfunction.

However, if you see large amounts of water accumulation, or large water drops building up inside the lenses, have your vehicle inspected by a dealer.

## ■ Hydrophilic Mirror

Your vehicle's door mirror surface is coated with hydrophilic film. Follow the next steps when the mirrors become less hydrophilic.

1. Rinse the door mirrors with water and remove dirt.
2. Wipe the mirrors with a clean damp cloth.
  - If you cannot remove dirt, use the genuine window cleaner, or neutral household detergent, and rinse with enough water.
3. Expose the mirrors to the sun for five to nine hours.

## » Hydrophilic Mirror

### NOTICE

To keep the hydrophilicity of the mirrors,

- Do not apply wax or water repellent agent on the mirror surface.
- Do not wipe the mirrors with a gritty cloth or abrasive cleanser.

## Accessories

When installing accessories, check the following:

- Do not install accessories on the windscreen. They can obstruct your view and delay your reaction to driving conditions.
- Do not install any items other than Honda genuine accessories designated for your vehicle over areas marked **SRS AIRBAG**, on the sides or backs of the front seats, on the sides of the rear seats, on front or side pillars, or near the side windows. Items other than Honda genuine accessories designated for your vehicle installed in these areas may interfere with proper operation of the vehicle's airbags or may be propelled into you or another occupant if the airbags deploy.
- Be sure electronic accessories do not overload electrical circuits or interfere with proper operation of your vehicle.
  - **Fuses** P. 764
- Before installing any electronic accessory, have the installer contact a dealer for assistance. If possible, have a dealer inspect the final installation.

### Accessories and Modifications

#### **WARNING**

Improper accessories or modifications can affect your vehicle's handling, stability, and performance, and cause a crash in which you can be seriously hurt or killed.

Follow all instructions in this owner's manual regarding accessories and modifications.

#### **WARNING**

Use of improperly designed, engineered or manufactured high-voltage battery assemblies could cause a fire in your vehicle.

A vehicle fire could result in a crash or injury.

Only use a genuine Honda high-voltage battery assembly, or its equivalent, in your vehicle.

## Modifications

Do not modify your vehicle in a manner that may affect its handling, stability, or reliability, or install non-genuine Honda parts or accessories that may have a similar effect.

Even minor modifications to vehicle systems can affect overall vehicle performance. Always make sure all equipment is properly installed and maintained, and do not make any modification to your vehicle or its systems that might cause your vehicle to no longer meet your country's and local regulations.

The on-board diagnostic port (OBD-II/SAE J1962 connector) installed on this vehicle is intended to be used with automobile system diagnostic devices or with other devices that Honda has approved. Use of any other type of device may adversely affect the vehicle's electronic systems or allow them to be compromised, possibly resulting in a system malfunction, drained battery, or other unexpected problems.

Do not modify or attempt to repair your vehicle's high-voltage hybrid power system or otherwise modify vehicle electrical systems. Disassembling or modifying electrical equipment can result in a crash or a fire.

If you ever need to replace your vehicle's high-voltage battery assembly outside of warranty coverage, we highly recommend that you only use a genuine Honda high-voltage battery assembly. Genuine Honda high-voltage battery assemblies are designed to work with your vehicle's hybrid power system and have been designed, engineered, and manufactured to avoid overcharging situations. Non-genuine high-voltage battery assemblies may not have been similarly designed, engineered, and manufactured, and installation of such assemblies could result in overcharging, fires, loss of power, or other conditions that may increase the likelihood of a crash or injury.

### ►► Accessories and Modifications

When properly installed, mobile phones, alarms, two-way radios, radio antennas, and low-powered audio systems should not interfere with your vehicle's computer controlled systems, such as your airbags and anti-lock brakes.

Honda Genuine accessories are recommended to ensure proper operation on your vehicle.

Some Honda genuine accessories are supplied with an exclusive owner's manual for the operation and care detail of the product. If an accessory owner's manual is provided to you, please refer to it for full detail.

If any Honda genuine accessories become inoperable, refer to the separate accessory owner's manual (if applicable) or consult a dealer for assistance to troubleshoot the potential faulty condition.

# Handling the Unexpected

This chapter explains how to handle unexpected troubles.



<b>If a Tyre Goes Flat</b> .....	736
<b>Handling of the Jack</b> .....	748
<b>Power System Won't Start</b>	
Checking the Procedure .....	749
If the Keyless Remote Battery is Weak ..	750
Emergency Power System On .....	751
Emergency Power System Off .....	752
<b>If the 12-Volt Battery Is Dead</b> .....	753
<b>Overheating</b> .....	755
<b>Indicator Coming On/Blinking</b>	
If the Engine oil pressure low Warning Appears.....	757
If the 12-Volt Battery Charging System Indicator Comes On .....	757

If the Reduced stopping power Warning Appears .....	758
If the Malfunction Indicator Lamp Comes On or Blinks .....	758
If the Brake System Indicator (Red) Comes On or Blinks .....	759
If the Electric Power Steering (EPS) System Indicator Comes On .....	760
If the Brake System Indicator (Red) Comes On or Blinks at the Same Time When the Brake System Indicator (Amber) Comes On .....	761
If the Low Tyre Pressure/Deflation Warning System Indicator Comes On or Blinks .....	762

If the Transmission System Indicator Blinks along with the Warning Message .....	762
If the High voltage battery thermal problem Warning Appears .....	763
<b>Fuses</b>	
Fuse Locations .....	764
Inspecting and Changing Fuses .....	768
<b>Emergency Towing</b> .....	771
<b>If You Cannot Open the Fuel Fill Door</b> .....	772
<b>If You Cannot Open the Charge Lid</b> .....	773
<b>If You Cannot Disengage the Charging Connector</b> .....	774
<b>If You Cannot Open the Tailgate</b> .....	775
<b>Evacuating the Vehicle in an Emergency</b> .....	776

## Temporarily Repairing a Flat Tyre

If the tyre has a large cut or is otherwise severely damaged, you will need to have the vehicle towed. If the tyre only has a small puncture, from a nail for instance, you can use the temporary tyre repair kit so that you can drive to the nearest service station for a more permanent repair.

If a tyre goes flat while driving, grasp the steering wheel firmly and brake gradually to reduce speed. Then, stop in a safe place.

1. Park the vehicle on a firm, level, non-slippery surface and apply the parking brake.
2. Put the transmission into **P**.
3. Turn on the hazard warning lights and set the power mode to VEHICLE OFF.

### Temporarily Repairing a Flat Tyre

The kit should not be used in the following situations. Instead, contact a dealer or a roadside assistance to have the vehicle towed.

- The tyre sealant has expired.
- More than one tyre is punctured.
- The puncture or cut is larger than 4 mm (3/16 inch).
- The tyre side wall is damaged or the puncture is outside the contact area.

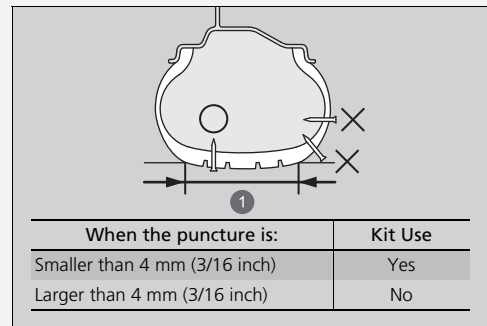

#### 1 Contact Area

- Damage has been caused by driving with the tyres extremely under inflated.
- The tyre bead is no longer seated.
- The rim is damaged.

Do not remove a nail or screw that punctured the tyre. If you remove it from the tyre, you may not be able to repair the puncture using the kit.

## ■ Getting Ready to Temporarily Repair the Flat Tyre

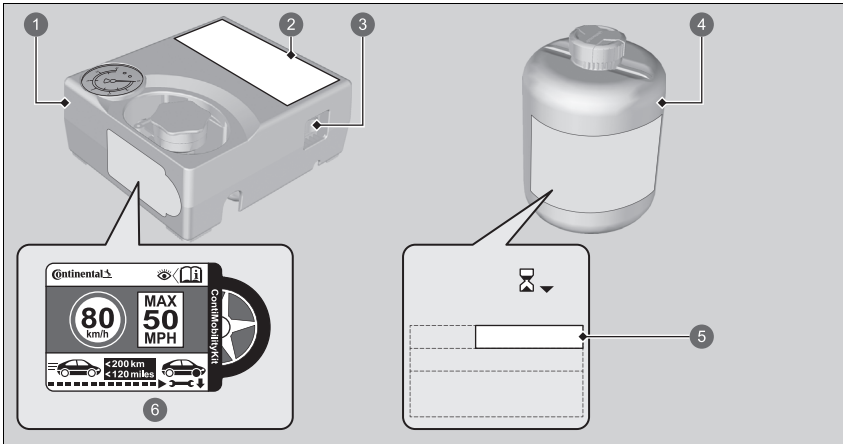

- ① Air Compressor
- ② Instruction Label
- ③ Air Compressor Switch
- ④ Sealant Bottle
- ⑤ Expiration Date
- ⑥ Speed Restriction Label

### ⊠ Getting Ready to Temporarily Repair the Flat Tyre

When making a temporary repair, carefully read the instruction label applied on the kit.

Speed restriction label is applied to the side of the temporary tyre repair kit.

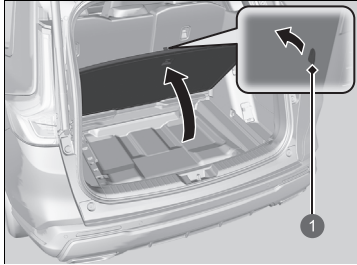

1. Open the tailgate.
2. Pull the strap and open the luggage area floor lid.

1 Strap

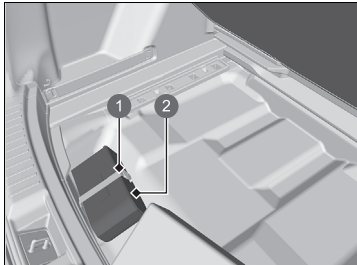

3. Unfasten the strap and take the bag out of the luggage area.
4. Take the kit out of the bag.
5. Place the kit face up on flat ground near the flat tyre away from traffic. Do not place the kit on its side.

1 Strap

2 Bag

## ■ Injecting Sealant and Air

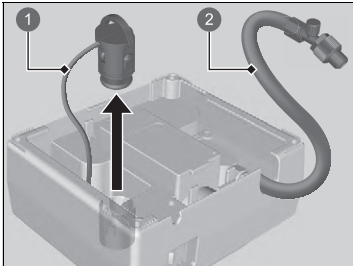

- ❶ Plug Cord
- ❷ Air Compressor Hose

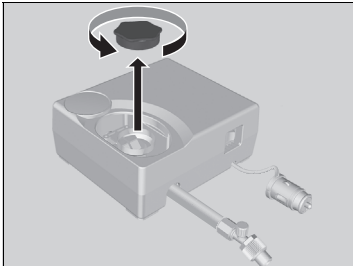

1. Take the air compressor hose and plug cord out of the back of the air compressor.

2. Remove the cap from the air compressor.

## ▣ Injecting Sealant and Air

### ⚠ WARNING

Tyre sealant contains substances that are harmful and can be fatal if swallowed.

If accidentally swallowed, do not induce vomiting. Drink plenty of water and get medical attention immediately.

For skin or eye contact, flush with cool water and get medical attention if necessary.

Keep the sealant bottle out of the reach of children.

In cold temperatures, the sealant may not flow easily. In this situation, warm it up for five minutes before use.

The sealant is latex based and can permanently stain clothing and other materials. Be careful during handling and wipe up any spills immediately.

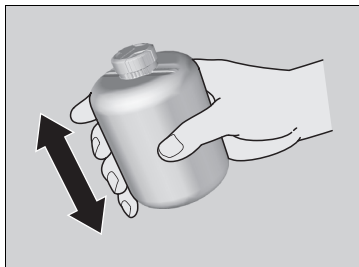

3. Shake the bottle well.

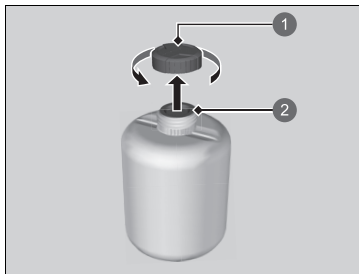

4. Remove the bottle cap.

▶ Do not remove the sealed cover.

- 1 Bottle Cap
- 2 Not Removed

#### ▶▶ Injecting Sealant and Air

Do not remove the empty bottle after injecting the sealant.

See a Honda dealer for a replacement of sealant bottle and proper disposal of the empty bottle.

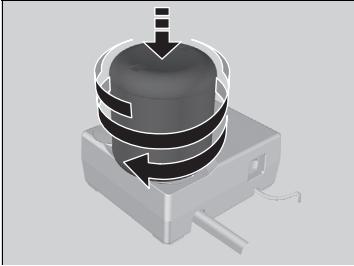

5. Screw the sealed bottle onto the air compressor.
  - ▶ Screw the bottle tightly so that it does not become loose.

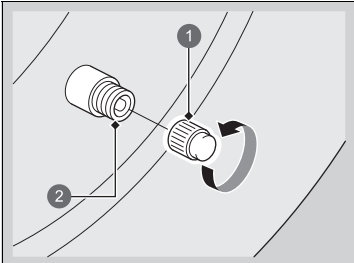

- 1 Valve Cap
- 2 Valve

6. Unscrew the valve cap.

▶▶ Injecting Sealant and Air

**⚠ WARNING**

Running the engine with the vehicle in an enclosed or even partly enclosed area can cause a rapid buildup of toxic carbon monoxide.

Breathing this colourless, odourless gas can cause unconsciousness and even death. Only run the engine to power the air compressor with the vehicle outdoors.

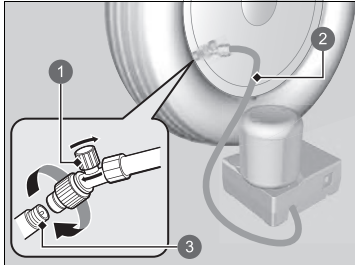

- ① Air Valve
- ② Air Compressor Hose
- ③ Valve

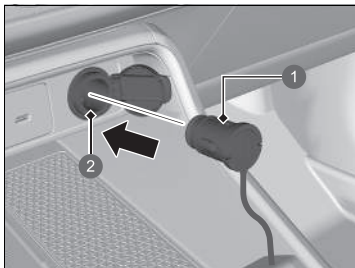

- ① Plug
- ② Accessory Power Socket

7. Screw the air compressor hose onto the tyre valve.
  - Make sure the air valve is closed and the air compressor is turned off.

8. Plug in the compressor to the accessory power socket.
  - Be careful not to pinch the cord in a door or window.
  - **Accessory Power Sockets** P. 276
9. Turn on the vehicle's power system.
  - **Carbon Monoxide Gas** P. 113

#### ►► Injecting Sealant and Air

Turn the air compressor off when connecting the air compressor hose.

You hear a motor sound coming from the activated air compressor. This is normal.

If the specified air pressure is not reached within 10 minutes, the tyre may be too severely damaged for the kit to provide the necessary seal and your vehicle will need to be towed.

If you want to measure the air pressure using a gauge, turn the air compressor off first.

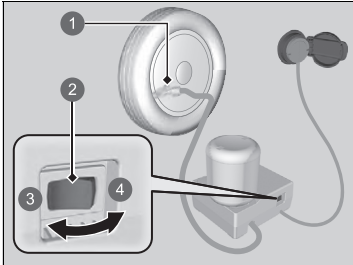

- ❶ Air Valve
- ❷ Switch
- ❸ OFF
- ❹ ON

10. Turn the air compressor on and inflate the tyre to the specified air pressure.
  - ▶ The compressor starts injecting sealant and air into the tyre.
  - ▶ Refer to the driver's doorjamb label for the specified pressure.
11. After the air pressure reaches the specified pressure, turn off the compressor.
  - ▶ Check the air pressure gauge on the air compressor.
  - ▶ If overinflated, release the air by turning the air valve. Be careful not to spill any sealant.
12. Unplug the plug from the accessory power socket.
13. Unscrew the air compressor hose from the tyre valve. Install the hose cap.
  - ▶ Be careful not to spill any sealant when the hose is disconnected. Wipe away any spills.
14. Store the tyre repair kit in the luggage area.
  - ▶ Do not remove the sealant bottle from the air compressor.

#### ✘ Injecting Sealant and Air

Inform the use of tyre sealant when you ask a Honda dealer or the road assistant service for replacing or repairing the flat tyre.

This air compressor is designed for the automotive tyre. Check the following:

- The power supply of the air compressor is limited to your vehicle's 12-volt DC accessory power socket.
- Do not operate the temporary tyre repair kit compressor for more than 15 minutes. The compressor can overheat and become permanently damaged. Make it cool down when using the compressor continuously.

## ■ Distributing the Sealant in the Tyre

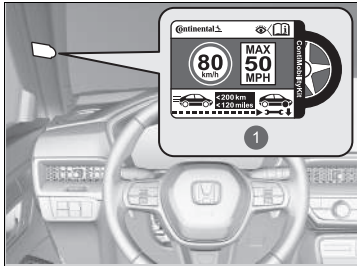

① Speed Restriction Label

1. Apply the speed restriction label to the location as shown.
2. Drive the vehicle for about 10 minutes or 3 to 10 kilometres (2 to 6 miles).
  - ▶ Do not exceed 80 km/h (50 mph).
3. Stop the vehicle in a safe place.

## ▶▶ Distributing the Sealant in the Tyre

### **⚠ WARNING**

Running the engine with the vehicle in an enclosed or even partly enclosed area can cause a rapid buildup of toxic carbon monoxide.

Breathing this colourless, odourless gas can cause unconsciousness and even death. Only run the engine to power the air compressor with the vehicle outdoors.

Refer to the driver's doorjamb label for the specified pressure.

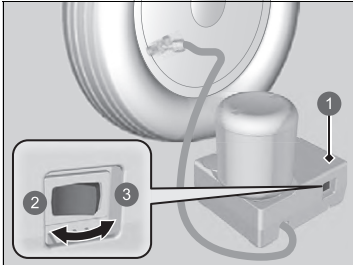

- ❶ Air Compressor
- ❷ OFF
- ❸ ON

4. Recheck the air pressure using the gauge on the air compressor.

► Do not turn the air compressor on to check the pressure.

5. If the air pressure is

- Less than 130 kPa (1.3 bar, 19 psi): Do not add air or continue driving. The leak is too severe. Call for help and have your vehicle towed.

➤ **Emergency Towing** P. 771

- Specified air pressure (See the label on driver's doorjamb.) or more: Continue driving until you reach the nearest service station. Do not exceed 80 km/h (50 mph).
- Greater than 130 kPa (1.3 bar, 19 psi), but less than specified air pressure (See the label on driver's doorjamb.): Inflate the tyre to the specified air pressure.

➤ **Inflating an Under-inflated Tyre**

P. 746

And repeat steps 2 to 4 until you reach the nearest service station. Do not exceed 80 km/h (50 mph).

► The distance to the nearest service station has to be within about 200 kilometres (120 miles).

6. Repackage and properly stow the kit.

## ■ Inflating an Under-inflated Tyre

You can use the kit to inflate a non-punctured under-inflated tyre.

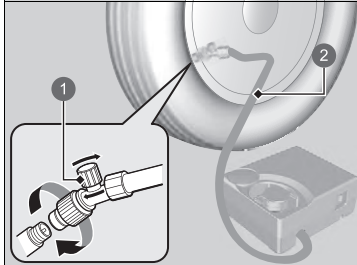

- 1 Air Valve
- 2 Hose

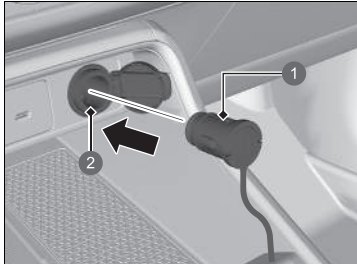

- 1 Plug
- 2 Accessory Power Socket

1. Take the air compressor out of the luggage area.
  - **Getting Ready to Temporarily Repair the Flat Tyre** P. 737
2. Place the kit face up on flat ground near the tyre to be inflated, away from traffic. Do not place the kit on its side.
3. Remove the valve cap.
4. Attach the hose onto the tyre valve. Screw it until it is tight.
  - Make sure the air valve is closed.
5. Plug in the compressor to the accessory power socket.
  - Be careful not to pinch the cord in a door or window.
  - **Accessory Power Sockets** P. 276
6. Turn on the vehicle's power system.
  - **Carbon Monoxide Gas** P. 113

## ►► Inflating an Under-inflated Tyre

### ⚠ WARNING

Running the engine with the vehicle in an enclosed or even partly enclosed area can cause a rapid buildup of toxic carbon monoxide.

Breathing this colourless, odourless gas can cause unconsciousness and even death.

Only run the engine to power the air compressor with the vehicle outdoors.

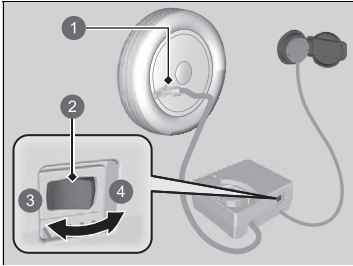

- ① Air Valve
- ② Switch
- ③ OFF
- ④ ON

7. Turn the air compressor switch on to inflate the tyre.
  - ▶ The compressor starts to inject air into the tyre.
  - ▶ If you have started the power system, leave it running while injecting air.
8. Inflate the tyre to the specified air pressure.
9. Turn off the air compressor.
  - ▶ Check the pressure gauge on the air compressor.
  - ▶ If overinflated, turn the air valve to deflate.
10. Turn the vehicle's power system off, then unplug the air compressor from the accessory power socket.
11. Unscrew the air compressor hose from the tyre valve. Reinstall the valve cap.
12. Store the air compressor in the luggage area.

#### ⓘ Inflating an Under-inflated Tyre

##### NOTICE

Do not operate the temporary tyre repair kit compressor for more than 15 minutes. The compressor can overheat and become permanently damaged.

# Handling of the Jack

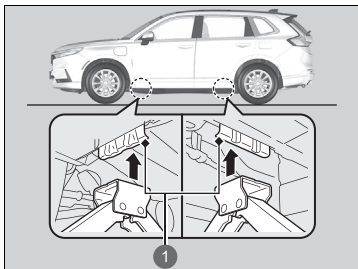

Your vehicle has jacking points as shown.  
When replacing your tyres, consult a dealer.



1 Jacking Points

## Checking the Procedure

If the power system won't start, check the following items and take appropriate action.

Checklist	Condition	What to Do
Check if the related indicator or driver information interface messages come on.	The  <b>Temperature is too low for vehicle to operate</b> appears.	<ul style="list-style-type: none"> <li>You must wait for an increase in the ambient temperature or move the vehicle to a warmer location.</li> <li>Contact dealer if necessary.</li> </ul>
	The  <b>To start, touch start button with emblem side of remote</b> appears.	➤ <b>If the Keyless Remote Battery is Weak</b> P. 750
	The transmission system indicator blinks and the  <b>Transmission system problem. Apply parking brake when parked.</b> appears.	➤ <b>If the Transmission System Indicator Blinks along with the Warning Message</b> P. 762
Check the fuses.		Check all fuses, or have your vehicle checked by a dealer. ➤ <b>Inspecting and Changing Fuses</b> P. 768
Check the power system starting procedure.		Follow the instructions, and try to start the power system again. ➤ <b>Turning on the Power</b> P. 428
Check the shift position.	The transmission is not in <b>P</b> .	Change the shift position to <b>P</b> .
Check the immobilizer system indicator.	When the immobilizer system indicator is blinking, the power system cannot be turned on.	<ul style="list-style-type: none"> <li>➤ <b>Immobilizer System</b> P. 213</li> <li>➤ <b>Immobilizer System Indicator</b> P. 127</li> </ul>

If you cannot turn on the power system after checking all the items in the list above, have your vehicle checked by a dealer.



If you must start the vehicle immediately, use an assisting vehicle or booster battery to jump start it.

➤ **If the 12-Volt Battery Is Dead** P. 753

Depending on the situation, it may be possible to temporarily turn the power system on using the emergency starting procedure.

➤ **Emergency Power System On** P. 751

## If the Keyless Remote Battery is Weak

If the beeper sounds, the  **To start, touch start button with emblem side of remote** message appears on the driver information interface, the **POWER** button flashes, and the  (Ready) indicator does not come on, turn on the power system as follows:

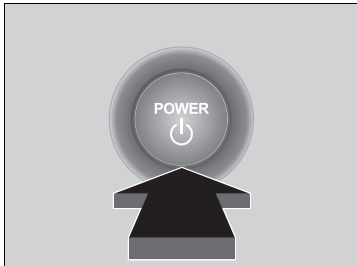
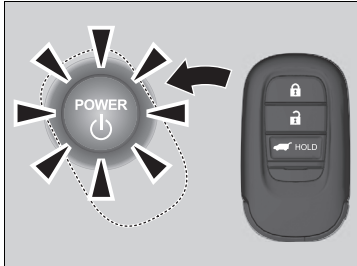

1. Press the **POWER** button.
  - ▶ The beeper sounds and the **POWER** button flashes for about 30 seconds.
2. Touch the centre of the **POWER** button with the **H** logo on the keyless remote while the **POWER** button is flashing. The buttons on the keyless remote should be facing you.
  - ▶ The beeper sounds, and the **POWER** button stays on for about 10 seconds.
3. Depress the brake pedal and press the **POWER** button while the **POWER** button is on.
  - ▶ The  (Ready) indicator comes on.
  - ▶ If you don't depress the pedal, the mode will change to ACCESSORY.

## Emergency Power System On

---

If the power system cannot be turned on using the normal starting procedure, you may be able to turn it on using the emergency starting procedure below.

Do not use this procedure if it is not an emergency.

1. Make sure the parking brake is applied.
2. Check that the transmission is in **[P]**, then set the power mode to ACCESSORY.
3. Firmly depress the brake pedal, then press and hold the **POWER** button for at least 15 seconds.

This should be considered a system malfunction even if you are able to turn the power system on using the above procedure.

Have your vehicle checked by a dealer immediately.

## Emergency Power System Off

The **POWER** button may be used to turn the power system off due to an emergency situation even while driving. If you must turn the power system off, do either of the following operations:

- Press and hold the **POWER** button for about two seconds.
- Firmly press the **POWER** button three times.

The steering wheel will not lock. However, because turning off the power system disables the power assist the power system provides to the steering and braking systems, it will require significantly more physical effort and time to steer and slow the vehicle. Use both feet on the brake pedal to slow down the vehicle and stop immediately in a safe place.

The transmission automatically changes to **P** after the vehicle comes to a complete stop. Then, the power mode changes to VEHICLE OFF.

### Emergency Power System Off

#### NOTICE

Do not press the **POWER** button while driving unless it is absolutely necessary for the power system to be turned off.

If you press the **POWER** button while driving, the beeper sounds.

# If the 12-Volt Battery Is Dead

## Jump Starting Procedure

Turn off the power to electric devices, such as audio and lights. Turn off the power system, then open the bonnet.

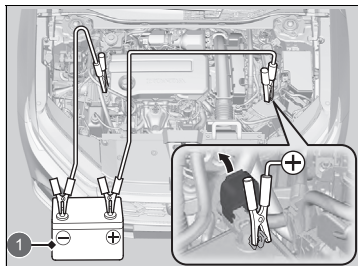

1 Booster Battery

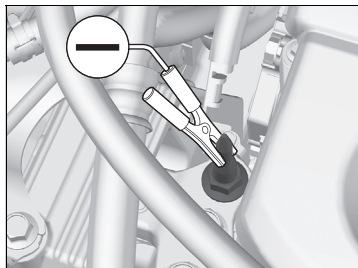

1. Open the battery terminal cover on your vehicle's 12-volt battery positive (+) terminal.
2. Connect the first jumper cable to your vehicle's 12-volt battery (+) terminal.
3. Connect the other end of the first jumper cable to the booster battery (+) terminal.
  - ▶ Use a 12-volt booster battery only.
  - ▶ When using an automotive battery charger to boost your 12-volt battery, select a lower charging voltage than 15-volt. Check the charger manual for the proper setting.
4. Connect the second jumper cable to the booster battery (-) terminal.
5. Connect the other end of the second jumper cable to the engine mounting bolt as shown. Do not connect this jumper cable to any other part.
6. If your vehicle is connected to another vehicle, start the assisting vehicle's engine and increase its RPM slightly.
7. Attempt to start your vehicle's engine. If it turns over slowly, check that the jumper cables have good metal-to-metal contact.

### Jump Starting Procedure

## ⚠ WARNING

A 12-volt battery can explode if you do not follow the correct procedure, seriously injuring anyone nearby.

Keep all sparks, open flames, and smoking materials away from the 12-volt battery.

### NOTICE

If a 12-volt battery sits in extreme cold, the electrolyte inside can freeze. Attempting to jump start with a frozen 12-volt battery can cause it to rupture.

Securely attach the jumper cables clips so that they do not come off when the engine vibrates. Be careful not to tangle the jumper cables or allow the cable ends to touch each other while attaching or detaching the jumper cables.

12-volt battery performance degrades in cold conditions and may prevent the engine from starting.

Continued

## ■ What to Do After the Power System Starts

Once your vehicle's power system has started, remove the jumper cables in the following order.

1. Disconnect the jumper cable from your vehicle's ground.
2. Disconnect the other end of the jumper cable from the booster battery ⊖ terminal.
3. Disconnect the jumper cable from your vehicle's 12-volt battery ⊕ terminal.
4. Disconnect the other end of the jumper cable from the booster battery ⊕ terminal.



Have your vehicle inspected by a nearby service station or a dealer.

## ▶▶ Jump Starting Procedure

The Vehicle Stability Assist (VSA) system, brake system (Amber), Adaptive Cruise Control (ACC) with Low Speed Follow, low tyre pressure/deflation warning system, Collision Mitigation Braking System (CMBS), Road Departure Mitigation, and safety support indicators may come on in amber along with a message in the gauge when you set the power mode to ON after reconnecting the 12-volt battery. Drive a short distance at more than 20 km/h (12 mph). Each indicator should go off. If any do not, have your vehicle checked by a dealer.

## How to Handle Overheating

Overheating symptoms are as follows:

- The  **Power system temperature high. Power may be reduced.** appears on the driver information interface.
- The  **Engine temperature too hot. Do not drive. Allow engine to cool.** appears on the driver information interface.
- Steam or spray comes out of the engine compartment.

### ■ The **Power system temperature high. Power may be reduced.** Appears on the Driver Information Interface

The  **Power system temperature high. Power may be reduced.** appears on the driver information interface when the power system temperature is high.

1. Immediately park the vehicle in a safe place.
  - ▶ Set the parking brake, and put the transmission into **P**. Turn off all accessories and turn on the hazard warning lights.
2. Keep the power mode in ON, and wait until the message disappears.
  - ▶ If the message does not disappear, have your vehicle inspected at a dealer.

### ■ The **Engine temperature too hot. Do not drive. Allow engine to cool.** Appears on the Driver Information Interface

#### ■ First thing to do

1. Immediately park the vehicle in a safe place.
2. Turn off all accessories and turn on the hazard warning lights.
  - ▶ **No steam or spray present:** Keep the power system on and open the bonnet.
  - ▶ **Steam or spray is present:** Turn off the power system and wait until it subsides. Then, open the bonnet.

#### ▶▶ How to Handle Overheating

### ⚠ WARNING

Steam and spray from an overheated engine can seriously scald you.

Do not open the bonnet if steam is coming out.

If the  **Power system temperature high. Power may be reduced.** appears on the driver information interface, your vehicle has less ability to accelerate and may be harder to start on an incline.

#### NOTICE

Continuing to drive with the  **Engine Temperature Too Hot. Allow Engine To Cool.** on the driver information interface may damage the engine.

### ■ Next thing to do

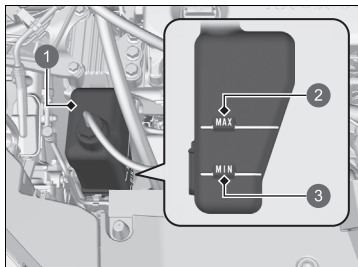

- 1 Reserve Tank
- 2 **MAX**
- 3 **MIN**

1. Check that the cooling fan is operating and turn the power system off once the  **Engine temperature too hot. Do not drive. Allow engine to cool.** on the driver information interface disappears.
  - If the cooling fan is not operating, immediately turn the power system off.
2. Once the engine has cooled down, inspect the coolant level and check the cooling system components for leaks.
  - If the coolant level in the reserve tank is low, add coolant until it reaches the **MAX** mark.
  - If there is no coolant in the reserve tank, check that the radiator is cool. Cover the radiator cap with a heavy cloth and open the cap. If necessary, add coolant up to the base of the filler neck, and put the cap back on.

### ■ Last thing to do

Once the engine has cooled sufficiently, turn the power system on.

If the  **Engine temperature too hot. Do not drive. Allow engine to cool.** does not appear, resume driving. If it appears again, contact a dealer for repairs.

### ►► How to Handle Overheating

## **WARNING**

Removing the radiator cap while the engine is hot can cause the coolant to spray out, seriously scalding you.

**Always let the engine and radiator cool down before removing the radiator cap.**

If the coolant is leaking, contact a dealer for repairs.

Use water as an emergency/temporary measure only. Have a dealer flush the system with proper antifreeze as soon as possible.

## If the Engine oil pressure low Warning Appears



### ■ Reasons for the warning to appear

Appears when the engine oil pressure is low.

### ■ What to do as soon as the warning appears

1. Immediately park the vehicle on level ground in a safe place.
2. If necessary, turn the hazard warning lights on.

### ■ What to do after parking the vehicle

1. Turn the power system off and let it sit for approximately three minutes.
2. Open the bonnet and check the oil level.
  - ▶ Add oil as necessary.
  - ▶ **Oil Check** P. 694
3. Start the engine and check the  **Engine oil pressure low** warning.
  - ▶ The warning disappears: Start driving again.
  - ▶ The warning does not disappear within 10 seconds: Immediately turn the power system off and contact a dealer for repairs.

## If the 12-Volt Battery Charging System Indicator Comes On



### ■ Reasons for the indicator to come on

Comes on when there is a problem with the charging system.

### ■ What to do when the indicator comes on

Stop in a safe place and have your vehicle checked by a dealer immediately.

### ⓘ If the Engine oil pressure low Warning Appears

#### NOTICE

Running the engine with low oil pressure can cause serious mechanical damage almost immediately.

### ⓘ If the 12-Volt Battery Charging System Indicator Comes On

If you need to stop temporarily, do not turn off the power system. The power system uses the 12-volt battery to activate. You may not be able to turn the power system on again if you have turned it off with this indicator on.

## If the Reduced stopping power Warning Appears



### ■ Reasons for the warning to appear

Appears when braking ability is reduced.

### ■ What to do as soon as the warning appears

Slow down and drive carefully. Have your vehicle checked by a dealer.

## If the Malfunction Indicator Lamp Comes On or Blinks



### ■ Reasons for the indicator lamp to come on or blink

- Comes on when there is a problem with the engine emissions control system or electric vehicle system.
- Blinks when engine misfiring is detected.

### ■ What to do when the indicator lamp comes on

- Avoid high speeds and immediately get your vehicle inspected at a dealer.
- Comes on when there is no petrol in the fuel tank, and goes off after vehicle is refueled, power mode is turned on, vehicle is driven, and the power system is turned off multiple times. If it does not go off, have your vehicle checked by a dealer.

### ■ What to do when the indicator lamp blinks

Park the vehicle in a safe place with no flammable items and wait at least 10 minutes or more with the engine stopped until it cools.

### ▶▶ If the Malfunction Indicator Lamp Comes On or Blinks

#### NOTICE

If you drive with the malfunction indicator lamp on, the emissions control system and the engine could be damaged.

If the malfunction indicator lamp blinks again when restarting the engine, drive to the nearest dealer at 50 km/h (30 mph) or less. Have your vehicle inspected.

## If the Brake System Indicator (Red) Comes On or Blinks



### ■ Reasons for the indicator to come on

- The brake fluid is low.
- There is a malfunction in the brake system.

### ■ What to do when the indicator comes on while driving

Depress the brake pedal lightly to check pedal pressure.

- If normal, check the brake fluid level the next time you stop.
- If abnormal, take immediate action. Pull the  deceleration paddle selector several times to help slow the vehicle using regenerative braking.

### ■ Reasons for the indicator to blink

- There is a problem with the electric parking brake system.

### ■ What to do when the indicator blinks

- Avoid using the parking brake and have your vehicle checked by a dealer immediately.

### ⚠ If the Brake System Indicator (Red) Comes On or Blinks

Have your vehicle repaired immediately.

It is dangerous to drive with low brake fluid. If there is no resistance from the brake pedal, stop immediately in a safe place. If necessary, pull the  deceleration paddle selector to help slow the vehicle using regenerative braking.

If the Brake System Indicator (Red) and **ABS** indicator come on simultaneously, the electronic brake distribution system is not working. This can result in vehicle instability under sudden braking. Have your vehicle inspected by a dealer immediately.

If the Brake System Indicator (Red) blinks at the same time when the Brake System Indicator (Amber) comes on, the parking brake may not work. Avoid using the parking brake and have your vehicle checked by a dealer immediately.

➡ **If the Brake System Indicator (Red) Comes On or Blinks at the Same Time When the Brake System Indicator (Amber) Comes On**  
P. 761

## If the Electric Power Steering (EPS) System Indicator Comes On

---



### ■ Reasons for the indicator to come on

Comes on when there is a problem with the EPS system or Driver Attention Monitor System.

### ■ What to do when the indicator comes on

- Stop the vehicle in a safe place and turn on the power system again. If the indicator comes on and stays on, immediately have your vehicle inspected by a dealer.
- If  **Do not drive** appears on the driver information interface, immediately stop in a safe place and contact a dealer.

## If the Brake System Indicator (Red) Comes On or Blinks at the Same Time When the Brake System Indicator (Amber) Comes On



(Red)



(Amber)

■ **If the Brake System Indicator (Red) comes on or blinks at the same time when the Brake System Indicator (Amber) comes on, release the parking brake manually or automatically**

➤ **Parking Brake** P. 590

- If the Brake System Indicator (Red) continuously comes on or blinks at the same time when the Brake System Indicator (Amber) comes on, stop the vehicle in a safe place and have it inspected by a dealer immediately.
  - ▶ To prevent the vehicle from moving, put the transmission into **P**.
- If only the Brake System Indicator (Red) is turned off, avoid using the parking brake and have your vehicle checked by a dealer immediately.

▣ If the Brake System Indicator (Red) Comes On or Blinks at the Same Time When the Brake System Indicator (Amber) Comes On

If you apply the parking brake, you may not be able to release it.

If the brake system indicator (red) and the brake system indicator (amber) come on at the same time, the parking brake is working.

If the brake system indicator (red) blinks at the same time when the brake system indicator (amber) comes on, the parking brake may not work because it is checking the system.

## If the Low Tyre Pressure/Deflation Warning System Indicator Comes On or Blinks



### ■ Reasons for the indicator to come on or blink

A tyre pressure is significantly low, or the deflation warning system has not been calibrated. If there is a problem with the deflation warning system, the indicator blinks for about one minute, and then stays on.

### ■ What to do when the indicator comes on

Drive carefully and avoid abrupt cornering and hard braking.

Stop your vehicle in a safe place. Check the tyre pressure and adjust the pressure to the specified level. The specified tyre pressure is on a label on the driver side doorjamb.

- ▶ Calibrate the deflation warning system after the tyre pressure is adjusted.

🔧 **Deflation Warning System** P. 469

### ■ What to do when the indicator blinks, then remains on

Have the tyre inspected by a dealer as soon as possible.

## If the Transmission System Indicator Blinks along with the Warning Message



### ■ Reasons for the indicator to blink

The transmission is malfunctioning.

### ■ What to do when the indicator blinks

Immediately have your vehicle inspected by a dealer.



🔧 If the Low Tyre Pressure/Deflation Warning System Indicator Comes On or Blinks

### NOTICE

Driving on an extremely underinflated tyre can cause it to overheat. An overheated tyre can fail. Always inflate your tyres to the prescribed level.

🔧 If the Transmission System Indicator Blinks along with the Warning Message

You may not be able to turn on the power system.

Make sure to set the parking brake when parking your vehicle.

Call a professional towing service if you need to tow your vehicle.

🔧 **Emergency Towing** P. 771

## If the High voltage battery thermal problem Warning Appears



### ■ Reasons for the warning to appear

- Appears when thermal runaway may be occurring in the High Voltage battery.
- Immediately stop in a safe place and apply the parking brake.

### ■ What to do after parking the vehicle

Immediately move away from the vehicle and contact a dealer.

⚠ If the High voltage battery thermal problem Warning Appears

## ⚠ WARNING

Do not approach the vehicle since it may emit harmful fumes. Even if the vehicle stops producing fumes, it may start again after some time.

## Fuse Locations

If any electrical devices are not working, set the power mode to VEHICLE OFF and check the power mode to VEHICLE OFF and check to see if any applicable fuse is blown.

### Engine Compartment Fuse Box

Located near the 12-volt battery. Push the tabs to open the box.

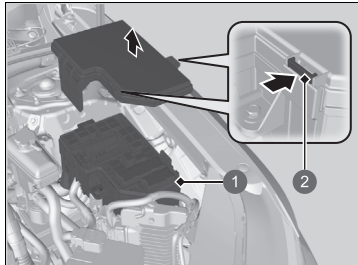

- 1 Fuse Box
- 2 Tab

Fuse locations are shown on the image below.

Locate the fuse in question by the fuse number in the image and chart.

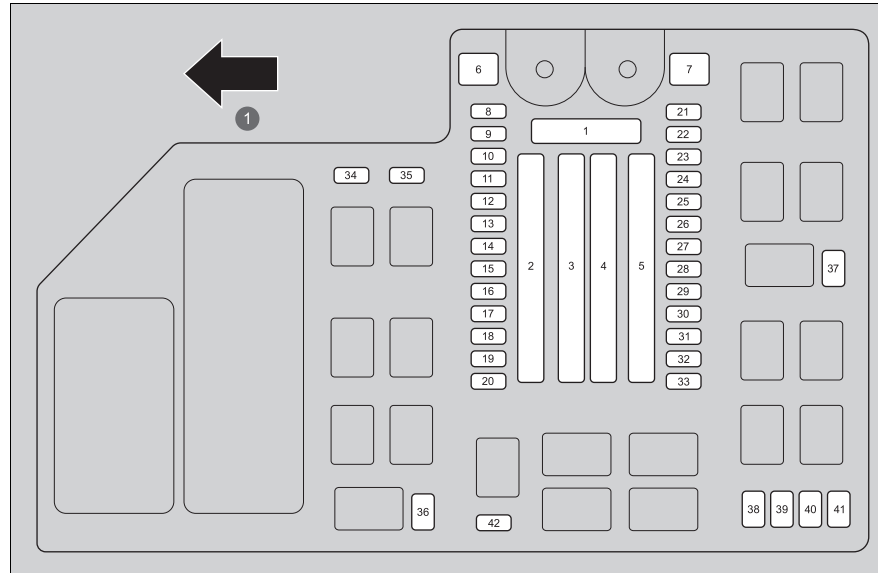

- 1 Front

■ **Circuit protected and fuse rating**

	Circuit Protected	Amps
1	Main Fuse	175 A
	–	30 A
	–	40 A
2	Fuse Box Option 1	60 A
	–	40 A
	Fuse Box Option 2	60 A
	–	60 A
	Fuse Box Main 1	60 A
3	Audio AMP	30 A
	–	30 A
	–	40 A
	Rear Demister	30 A
	–	50 A
	Blower Motor	40 A
	Power Tailgate Motor	40 A
	ABS/VSA FSR	40 A
	ABS/VSA Motor	40 A
	Engine EWP	40 A
4	Electric Servo Brake	40 A
	IG Main 1	30 A
	RFC Sub	40 A
	IG Main 2	30 A

	Circuit Protected	Amps
5	Sub Fuse 1	30 A
	Wiper	30 A
	EPS	70 A
	–	30 A
	RFC Main	40 A
	P-ACT Motor	30 A
	Fuse Box Main 2	60 A
6	–	–
7	Relay Module 2	20 A
8	A/C Main	10 A
9	Back Up	10 A
10	–	–
11	Rear Fog Light	10 A
12	EWWLT	10 A
13	Audio Sub	7.5 A
14	EWWHT	10 A
15	Headlight Adjuster*	(10 A)
16	SOV	10 A
17	ECH 1	10 A
18	Horn	15 A
19	Front Washer	15 A
20	Audio	15 A
21	Relay Module 1	20 A
22	DBW	15 A
23	Hazard	10 A
24	VBU	10 A
25	IGP	15 A

	Circuit Protected	Amps
26	Electric VTC	20 A
27	Left Headlight	20 A
28	Injector	20 A
29	Stop lights	10 A
30	Right Headlight	20 A
31	IG Coil	15 A
32	ICM	10 A
33	PCU EWP	10 A
34	EWPLT 2	10 A
35	ECOMP	10 A
36	–	–
37	–	–
38	IGA	10 A
39	IGB	10 A
40	P-ACT Unit	10 A
41	IGPS LAF	7.5 A
42	IG1 Monitor 2	5 A

\* Not available on all models



■ Circuit protected and fuse rating

	Circuit Protected	Amps
1	Driver's Power Window	20 A
2	Front Passenger's Power Window	20 A
3	Rear Right Side Power Window	20 A
4	Rear Left Side Power Window	20 A
5	Option	10 A
6	SRS	10 A
7	–	–
8	RVU	10 A
9	Front Accessory Power Socket	20 A
10	Door Lock	20 A
11	Meter	10 A
12	–	–
13	Option 2	10 A
14	Option 6 (VB SOL)	10 A
15	Driver's Door Unlock	10 A
16	IMG	10 A
17	–	–
18	–	–
19	–	–
20	USB Charger	10 A
21	Accessory Power Socket (Luggage Area)	20 A
22	SMART	10 A

	Circuit Protected	Amps
23	Driver's Door Lock	10 A
24	Adaptive Damper System	15 A
25	SBW	10 A
26	SRS	10 A
27	ACG	10 A
28	Option 5 (ABS)	10 A
29	Fuel Pump	20 A
30	Left Side Door Unlock	10 A
31	Right Side Door Unlock	10 A
32	Panoramic Roof	20 A
33	–	10 A
34	–	–
35	Sunshade	20 A
36	Rear Seat Heater	(20 A)
37	–	–
38	Lock/ Unlock Actuator	10 A
39	Right Side Door Lock	10 A
40	Driver's Power Seat Sliding	20 A
41	Driver's Power Seat Reclining	20 A
42	P-ACT	10 A
43	Option	10 A
44	Daytime Running Light	5 A
45	ACC	10 A
46	–	–
47	Left Side Door Lock	10 A
48	Front Seat Heater	20 A

	Circuit Protected	Amps
49	Passenger's Power Seat Reclining	20 A
50	Power Seat Lumbar Support	10 A
51	IGC	10 A
52	Power Tailgate Closer	20 A
53	Passenger's Power Seat Sliding	20 A
54	Option 1	10 A
55	–	–
56	–	–

## Inspecting and Changing Fuses

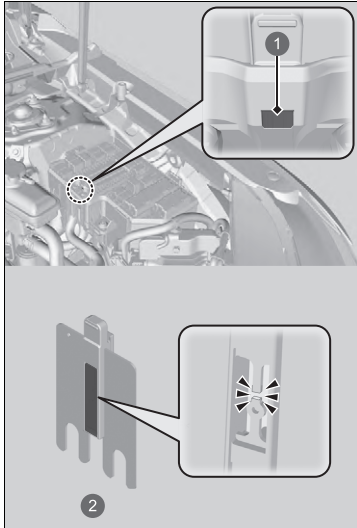

- 1 Hole
- 2 Main Fuse

1. Set the power mode to VEHICLE OFF. Turn headlights and all accessories off.
2. Remove the fuse box cover.
3. Check the main fuse in the engine compartment fuse box.
  - Look at the fuse through the hole.
  - If the fuse is blown, have it replaced by a dealer.

### ► Inspecting and Changing Fuses

#### NOTICE

Replacing a fuse with one that has a higher rating greatly increases the chances of damaging the electrical system.

Use the charts to locate the fuse in question and confirm the specified amperage.

► **Fuse Locations** P. 764

Replace with a fuse of the same specified amperage.

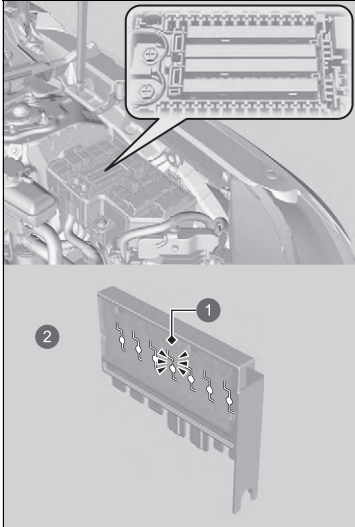

4. Check the combined fuses in the engine compartment fuse box.
  - ▶ Look into the space between the fuses.
  - ▶ If the fuse is blown, have it replaced by a dealer.

- ① Blown Fuse
- ② Combined Fuse

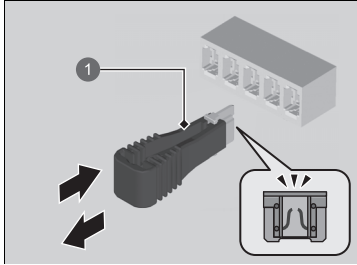

1 Fuse Puller

5. Inspect the small fuses in the engine compartment and the vehicle interior.
  - If there is a blown fuse, remove it with a commercially available fuse puller and replace it with a new one.

Call a professional towing service if you need to tow your vehicle.

## ■ Flatbed equipment

The operator loads your vehicle on the back of a truck.

**This is the best way to transport your vehicle.**

## ■ Wheel lift equipment

The tow truck uses two pivoting arms that go under the front tyres and lift them off the ground. The rear tyres remain on the ground. **This is an acceptable way to tow your vehicle.**

## » Emergency Towing

### NOTICE

Trying to lift or tow your vehicle by the bumpers will cause serious damage. The bumpers are not designed to support the vehicle's weight.

Make sure the parking brake is released. If you cannot release the parking brake, your vehicle must be transported by the flatbed equipment.

➤ **Parking Brake** P. 590

Improper towing such as towing behind a motorhome or other motor vehicle can damage the transmission.

Never tow your vehicle with just a rope or chain. It is very dangerous since ropes or chains may shift from side to side or break.

### Right-hand Drive Type

Before towing your vehicle, deactivate the security system's tilt sensor if you have to set the system.

➤ **Tilt Sensor\*** P. 217

\* Not available on all models

# If You Cannot Open the Fuel Fill Door

## ■ What to Do If Unable to Open the Fuel Fill Door

If you cannot open the fuel fill door, use the following procedure.

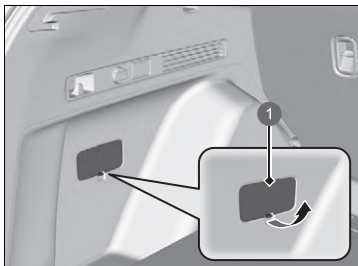

1 Cover

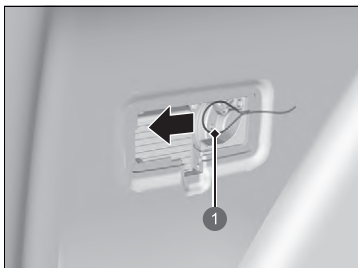

1 Release Cord

1. Open the tailgate and remove the cover.

2. Pull the release cord toward you.
  - ▶ The lid will pop up slightly.
3. Open the fuel fill door.
4. Slowly remove the fuel fill cap by turning it to the left. If you hear a release of pressure, wait until it stops, then continue to slowly remove the fuel fill cap.

📖 **How to Refuel** P. 652

5. Add fuel very slowly.
  - ▶ The automatic fuel tank vent does not operate when the fuel fill door is opened manually. Trying to add fuel too rapidly when the vent valve is closed will cause fuel vapors to be pushed out the filler pipe and can cause a small amount of liquid fuel to be spilled onto the ground.

## 📖 What to Do If Unable to Open the Fuel Fill Door

### **⚠️ WARNING**

Petrol vapors in tank are under pressure.

- If using the manual fuel door release, open the cap slowly to gradually release pressure.
- Turn off the power system, and keep all sparks, heat, and flames away.

The automatic fuel tank vent does not operate when using the manual fuel door release. Gradually release pressure by slowly turning the fuel fill cap to the left. If you hear a release of air, wait until it stops, then continue to slowly remove the fuel fill cap.

After taking these steps, contact a dealer to have the vehicle checked.

# If You Cannot Open the Charge Lid

## ■ What to Do If Unable to Open the Charge Lid

If you cannot open the charge lid, use the following procedure.

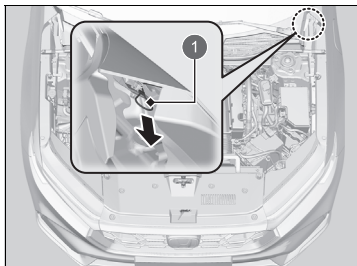

1 Release Cord

1. Open the bonnet.
  - **Opening the Bonnet** P. 690
2. Pull the release cord located as shown.
  - ▶ The lid will pop up slightly.
    - **How to Charge (AC 230 V)** P. 658

## ☒ What to Do If Unable to Open the Charge Lid

After taking this step, contact a dealer to have the vehicle checked.

## ■ What to Do If Unable to Disengage the Charging Connector

### ■ When the Charging connector release problem. message Appears on the Driver Information Interface

The  **Charging connector release problem.** message appears on the driver information interface when you cannot disengage the charging connector. Disengage the charging connector as follows.

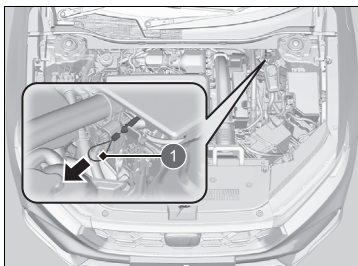

① Release Cord

1. Make sure that charging is completed correctly.
2. Open the bonnet.
3. Pull the release cord.
  - ▶ The release cord returns to its original position at the next charging.
4. Disengage the charging connector from the inlet.

### ■ If the Remote Battery Is Weak

The charging connector cannot be disengaged if the door is locked while the keyless remote cannot be detected, such as when the battery is weak.

You can disengage the charging connector by pressing the release button in the inlet by unlocking the door with the built-in key.

➤ **Replacing the Remote Battery** P. 721

➤ **If the Keyless Remote Battery is Weak** P. 750

## ➤ What to Do If Unable to Disengage the Charging Connector

If the problem that you cannot disengage the charging connector occurs repeatedly, contact a dealer to have the vehicle checked.

# If You Cannot Open the Tailgate

## What to Do If Unable to Open the Tailgate

If you cannot open the tailgate, use the following procedure.

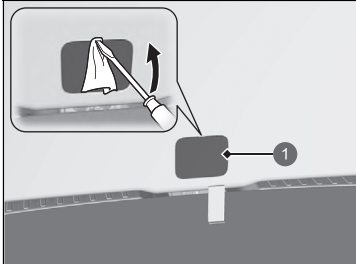

1 Cover

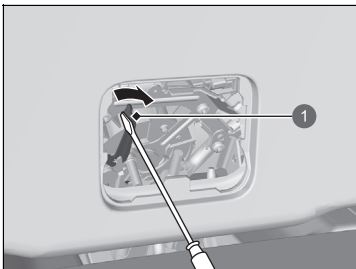

1 Lever

1. Use a flat-tip screwdriver and remove the cover on the back of the tailgate.
  - ▶ Wrap the flat-tip screwdriver with a cloth to prevent scratches.

2. To open the tailgate, push the tailgate while sliding the lever to the right with the flat-tip screwdriver.

## What to Do If Unable to Open the Tailgate

When you open the tailgate from inside, make sure there is enough space around the tailgate, and it does not hit anyone or any object.

Following up:

After taking these steps, contact a dealer to have the vehicle checked.

# Evacuating the Vehicle in an Emergency

If you cannot open the door in an emergency, lower the power window and exit through the window frame. If the power window does not operate, use the following procedure to evacuate the vehicle.

## ■ Evacuating when the power window does not operate

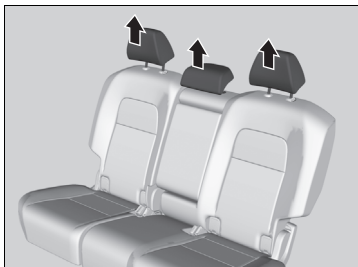

1. Remove the rear seat head restraint.

▣ **Head Restraints** P. 259

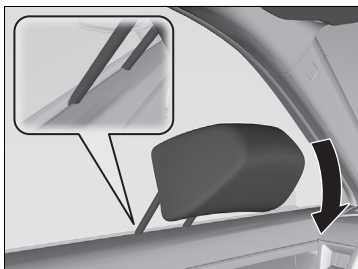

2. Insert the head restraint legs into the lower centre of the front door window.

3. Push the head restraint down towards you to break the door glass.

4. Remove the door glass and evacuate outside the vehicle.

- ▶ If you cannot remove the door glass, perform any necessary actions (such as kicking, etc.) to remove it.
- ▶ When breaking the door glass to evacuate, be careful not to be injured by glass shards.

## ▣ Evacuating when the power window does not operate

Be careful when breaking the door glass to evacuate a submerged vehicle. External water pressure may break the door glass and cause glass shards to enter the vehicle.

If you cannot evacuate from the front door, use the same procedure to evacuate by breaking a rear door window. It may be more difficult to insert the head restraint legs into a rear door window. Also, be careful as the rear door window may shatter all at once.



# Information

This chapter includes your vehicle's specifications, locations of identification numbers, and other information required by regulation.

<b>Specifications</b> .....	780
<b>Identification Numbers</b>	
Vehicle Identification Number (VIN), Engine Number, Motor Number and Transmission Number.....	783
<b>Devices that Emit Radio Waves*</b> .....	784
<b>Declaration of conformity Content</b>	
<b>Outline*</b> .....	827
<b>Open Source Licence</b> .....	830

\* Not available on all models

## ■ Vehicle Specifications

Model	CR-V
Curb Weight	1,911 - 1,928 kg
Maximum Permissible Weight	See the certification label on the driver's doorjamb <sup>*1</sup> See the certification label on the passenger's doorjamb <sup>*2</sup>
Maximum Permissible Axle Weight	See the certification label on the driver's doorjamb <sup>*1</sup> See the certification label on the passenger's doorjamb <sup>*2</sup>

\*1: Left-hand drive type

\*2: Right-hand drive type

## ■ Engine Specifications

Type	Water-cooled in-line 4-cylinder DOHC	
Bore x Stroke	81.0 x 96.7 mm (3.19 x 3.81 in)	
Displacement	1,993 cm <sup>3</sup> (121.6 cu-in)	
Compression Ratio	13.9 : 1	
Spark Plugs	NGK	DILZKAR7G11Y

## ■ Fuel

Type	· EN 228 standards petrol/gasohol fuel · Unleaded premium petrol/gasohol up to E10 (90% petrol and 10% ethanol), research octane number 95 or higher
Fuel Tank Capacity	46.5 L (10.2 Imp gal)

## ■ 12-Volt Battery

Capacity	36AH(5)/45AH(20)
----------	------------------

## ■ Washer Fluid

Tank Capacity	1.5 L (1.3 Imp qt)
---------------	--------------------

## ■ Light Bulbs

Headlights (Low Beam)	LED
Headlights (High Beam)	LED
Front Turn Signal/Position/Daytime Running Lights	LED
Active Cornering Lights <sup>*</sup>	LED
Side Turn Signal Lights (on Door Mirrors)	LED
Brake Lights	LED
Taillights	LED
Rear Turn Signal Lights	LED
Rear Side Marker Lights	LED
Back-Up Light	LED
Rear Fog Light	LED
Rear Licence Plate Light	LED
High-Mount Brake Light	LED
Interior Lights	
Front Map Lights	LED
Rear Map Lights	LED
Ambient Lights	LED
Vanity Mirror Lights	2 W
Console Compartment Light	LED
Door Inner Handle Lights	LED
Foot Lights	LED
Centre Console Light	LED
Beverage Holder Light	LED
Luggage Area Lights	LED

### ■ Brake Fluid

Specified	Brake Fluid with DOT 3 or DOT 4
-----------	---------------------------------

### ■ Air Conditioning

Refrigerant Type	HFO-1234yf (R-1234yf)
Charge Quantity	525 - 575 g (18.5 - 20.3 oz)

### ■ Transmission Fluid

Specified	Honda HEVF-Type1
Capacity	Change 2.4 L (2.1 Imp qt)

### ■ Engine Oil

Recommended	Except Cypriot, Israeli, Moldova, and Ukrainian models
	Honda Engine Oil Type 2.0
	Honda Genuine Motor Oil 0W-20
	ACEA C5 0W-20
Capacity	Cypriot, Israeli, Moldova, and Ukrainian models
	Honda Genuine Motor Oil 0W-20
	ACEA C5 0W-20
	Change 3.7 L (3.3 Imp qt)
Change including filter	4.0 L (3.5 Imp qt)

### ■ Engine Coolant

Specified	Honda All Season Antifreeze/Coolant Type2
Ratio	50/50 with distilled water
Capacity	5.94 L (1.31 Imp gal) <sup>*1</sup> /5.95 L (1.31 Imp gal) <sup>*2</sup> (change including the remaining 0.72 L (0.16 Imp gal) in the reserve tank)

\*1: Left-hand drive type  
\*2: Right-hand drive type

### ■ Tyre

Regular	Size	235/60R18 103H <sup>*1</sup>
		235/55R19 101Y <sup>*2</sup>
Wheel Size	Regular	18 x 7 1/2J <sup>*1</sup>
		19 x 7 1/2J <sup>*2</sup>

For the tyre size and pressure information, see the label on driver's doorjamb.

\*1: Models with 18 inch wheel  
\*2: Models with 19 inch wheel

### ■ Honda TRK Air Compressor

A weighted emission sound pressure level	82 dB (A)
A weighted sound power level	90 dB (A)

### ■ Brake

Type	Power assisted
Front	Ventilated disc
Rear	Solid disc
Parking	Electric Parking Brake

### ■ Vehicle Dimensions

Length	4,706 mm	
Width	1,866 mm	
Height	1,673 mm	
Wheelbase	2,701 mm	
Track	Front	1,612 mm
	Rear	1,640 mm

■ **The mounting point/rear over hang of coupling device**

**Dimensions**

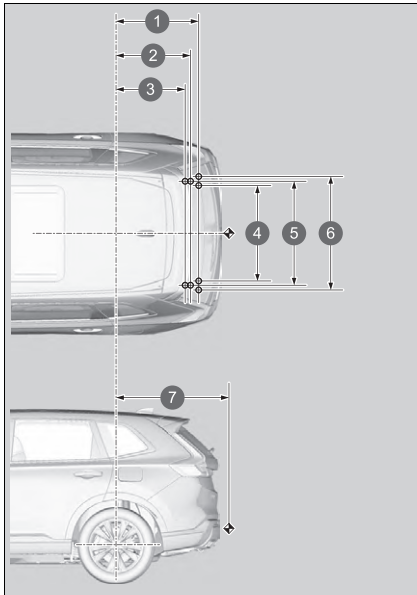

- ❶ 788 mm (31.0 in)
- ❷ 673 mm (26.5 in)
- ❸ 639 mm (25.2 in)
- ❹ 958 mm (37.7 in)
- ❺ 980 mm (38.6 in)
- ❻ 1,042 mm (41.0 in)
- ❼ 1,116 mm (43.9 in)

NOTE:

- 1. ○ marks show towbar fixing points.
- 2. ◈ mark shows towbar coupling point.

■ **Max. Towing Weight**

Trailer with brakes	1,500 kg (3,307 lbs)
Trailer without brakes	600 kg (1,323 lbs)
The maximum permissible vertical load on the coupling device	100 kg (220 lbs)

## Vehicle Identification Number (VIN), Engine Number, Motor Number and Transmission Number

Your vehicle has a 17-digit vehicle identification number (VIN) used to register your vehicle for warranty purposes, and for licensing and insuring your vehicle. The locations of your vehicle's VIN, engine number, motor number and transmission number are shown as follows.

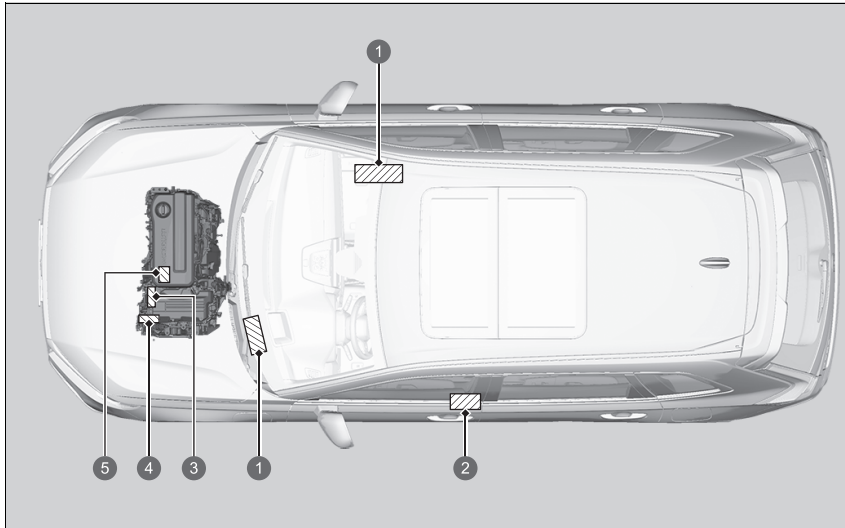

- 1 Vehicle Identification Number
- 2 Certification Label/Vehicle Identification Number/Engine Number
- 3 Motor Number
- 4 Transmission Number
- 5 Engine Number

### Vehicle Identification Number (VIN), Engine Number, Motor Number and Transmission Number

The interior vehicle identification number (VIN) is located under the cover.

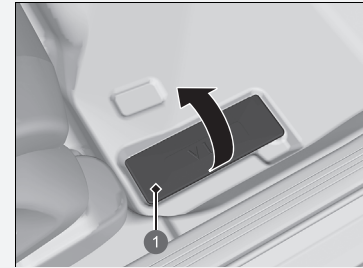

- 1 Cover

# Devices that Emit Radio Waves\*

The following products and systems on your vehicle emit radio waves when in operation.

## Israeli models

BCM Keyless Access System	FOB Keyless Access System
<p>"מספר אישור התאמה מטעם משרד התקשורת : 51-74423"</p> <p>חל איסור לבצע פעולות במכשיר שיש בהן כדי לשנות את תכונותיו האלחוטיות של המכשיר, ובכלל זה שינויי תוכנה, החלפת אנטנה מקורית או הוספת אפשרות לחיבור לאנטנה חיצונית, בלא קבלת אישור משרד התקשורת בשל החשש להפרעות אלחוטיות.</p>	<p>"מספר אישור התאמה מטעם משרד התקשורת : 51-74074"</p> <p>חל איסור לבצע פעולות במכשיר שיש בהן כדי לשנות את תכונותיו האלחוטיות של המכשיר, ובכלל זה שינויי תוכנה, החלפת אנטנה מקורית או הוספת אפשרות לחיבור לאנטנה חיצונית, בלא קבלת אישור משרד התקשורת בשל החשש להפרעות אלחוטיות.</p>

## Israeli models

Adaptive Cruise Control/ Collision Mitigation Braking System
<p>מספר זיהוי היבואן: 510485261</p> <p>חל איסור לבצע פעולות במכשיר שיש בהן כדי לשנות את תכונותיו האלחוטיות של המכשיר, ובכלל זה שינויי תוכנה, החלפת אנטנה מקורית או הוספת אפשרות לחיבור לאנטנה חיצונית, בלא קבלת אישור משרד התקשורת, בשל החשש להפרעות אלחוטיות.</p>

## Devices that Emit Radio Waves\*

### Israeli models

Due to concerns about radio interference, it is prohibited to operate the device with modified wireless characteristics of this device without obtaining the approval of the Ministry of Communications. This includes such as modifying the software, replacing the genuine antenna, and adding the connection option to external antenna. Due to concerns about radio interference, outdoor operation of this device is prohibited.

## Israeli models

## Hands-Free Telephone System

מספר אישור התאמה מטעם משרד התקשורת: 56-18970  
 חל איסור לבצע פעולות במכשיר שיש בהן כדי לשנות את תכונותיו האלחוטיות של המכשיר, ובכלל זה שינויי תוכנה, החלפת אנטנה מקורית או הוספת אפשרות לחיבור לאנטנה חיצונית, בלא קבלת אישור משרד התקשורת, בשל החשש להפרעות אלחוטיות.

## Israeli models

## Blind Spot Information System/Cross Traffic Monitor

מספר זיהוי היבואן: 510485261

חל איסור לבצע פעולות במכשיר שיש בהן כדי לשנות את תכונותיו האלחוטיות של המכשיר, ובכלל זה שינויי תוכנה, החלפת אנטנה מקורית או הוספת אפשרות לחיבור לאנטנה חיצונית, בלא קבלת אישור משרד התקשורת, בשל החשש להפרעות אלחוטיות.

## Wireless Charger

56-05793

Serbian models

BCM  
Keyless Access System

<http://continental-homologation.com/honda>



Akcionarsko društvo za ispitivanje kvaliteta KVALITET NIS  
Акционарско друштво за испитивање квалитета КВАЛИТЕТ НИС  
Joint-stock company for quality testing KVALITET NIS



POTVRDA O USAGLAŠENOSTI - RITTO Broj: P1620114200  
CONFIRMATION OF CONFORMITY - R&TTE No.

Podnosioc zahteva: RTTE CONSULTING DOO  
Applicant: 11590 BEOGRAD-RAKOVIČA  
KNEŽA VIŠEŠLAVA 632/7

Vrsta opreme: AUDIO VIDEO KOMUNIKACIONI KONTROLER ZA AUTOMOBIL  
Equipment category:

Oznaka tipa/modela: 4150430  
Equipment type/model:

Robna marka: Continental  
Equipment trademark:  
Proizvođač: Continental Automotive GmbH  
Manufacturer: Germany

Vrednovana dokumentacija / Evaluated documentation:  
Laboratorija / Beograd/Savez / Compliance Certification Services Inc. / T200507W04-LV, 16.06.2020 /  
Ispitni levelaj / T200507W04-MC, 11.06.2020 /  
Laboratory / EMF/EMC Compliance Certification Services Inc. / T200507W04-RE, 10.06.2020 /  
Test report: RTT&R&TTE, Compliance Certification Services Inc. / T200507W04-RT2, 14.07.2020 /  
T200507W04-RT, 08.07.2020 /

Na osnovu gore navedene dokumentacije utvrđeno je da gore navedena oprema zadovoljava zahtevе Правилника o radio opremi (telekomunikacioni terminalni opremi) (E, članak 92, 110912).

Nastale promene u specifikaciji, tipu/modelu, komponentama, električnim karakteristikama opreme koji utiču na usaglašenost sa izdanim Pravilnikom moraju se prijaviti "Kvalitet"-u s.d. NIS.  
Any changes occur in the specification, type/model, components of the design, electrical characteristics of the equipment which may influence on conformity to the above mention Rulesbook, shall be forwarded to "Kvalitet".

Mesto i datum izdavanja: Novi Sad, 25.07.2020.

Ваши до: 27.07.2023.  
Vladimir Vukadinović, dipl. inž.

Ovaj dokument važi samo za proizvode koji su izdvojeni sa proizvoda koji su bili predmet vrednovanja.  
Bul. Svetog Cara Konstantina 82-86, NIS 18000, Srbija, Tel: (016)550-766, 550-634, Fax: (016)550-436, 550-068  
e-mail: office@kvalitet.co.rs, http://www.kvalitet.co.rs

FOB  
Keyless Access System

<http://continental-homologation.com/honda>



Akcionarsko društvo za ispitivanje kvaliteta KVALITET NIS  
Акционарско друштво за испитивање квалитета КВАЛИТЕТ НИС  
Joint-stock company for quality testing KVALITET NIS



POTVRDA O USAGLAŠENOSTI - RITTO Broj: P1620075600  
CONFIRMATION OF CONFORMITY - R&TTE No.

Podnosioc zahteva: RTTE CONSULTING DOO  
Applicant: 11590 BEOGRAD-RAKOVIČA  
KNEŽA VIŠEŠLAVA 632/7

Vrsta opreme: KLJUČ ZA DALJINSKI PRISTUP VOZILU  
Equipment category:

Oznaka tipa/modela: TP\_4  
Equipment type/model:

Robna marka: Continental  
Equipment trademark:  
Proizvođač: Continental Automotive GmbH  
Manufacturer: Germany

Vrednovana dokumentacija / Evaluated documentation:  
Laboratorija / Beograd/Savez / Compliance Certification Services Inc. / T200419W01-LV, 11.05.2020 /  
Ispitni levelaj / T200419W01-MC, 07.06.2020 /  
Laboratory / EMF/EMC Compliance Certification Services Inc. / T200419W01-RE, 07.06.2020 /  
Test report: RTT&R&TTE, Compliance Certification Services Inc. / T200419W01-RT1, 07.05.2020 /  
T200419W01-RT2, 07.05.2020 /

Na osnovu gore navedene dokumentacije utvrđeno je da gore navedena oprema zadovoljava zahtevе Правилника o radio opremi (telekomunikacioni terminalni opremi) (E, članak 92, 110912).

Nastale promene u specifikaciji, tipu/modelu, komponentama, električnim karakteristikama opreme koji utiču na usaglašenost sa izdanim Pravilnikom moraju se prijaviti "Kvalitet"-u s.d. NIS.  
Any changes occur in the specification, type/model, components of the design, electrical characteristics of the equipment which may influence on conformity to the above mention Rulesbook, shall be forwarded to "Kvalitet".

Mesto i datum izdavanja: Novi Sad, 25.07.2020.

Ваши до: 27.07.2023.  
Vladimir Vukadinović, dipl. inž.

Ovaj dokument važi samo za proizvode koji su izdvojeni sa proizvoda koji su bili predmet vrednovanja.  
Bul. Svetog Cara Konstantina 82-86, NIS 18000, Srbija, Tel: (016)550-766, 550-634, Fax: (016)550-436, 550-068  
e-mail: office@kvalitet.co.rs, http://www.kvalitet.co.rs

## Serbian models

## Adaptive Cruise Control/ Collision Mitigation Braking System



Postal address: Peter-Dornier-Strasse 10, 88131 Lindau, Germany

Manufacturer name: ADC Automotive Distance Control Systems GmbH

Importer Name: Delta Automoto d.o.o.

Postal address: OMLADINSKIH BRIGADA 33A, 11070 NOVI BEOGRAD, SERBIA

Ovim, ADC Automotive Distance Control Systems GmbH izjavljuje da je tip radio opreme ARS5-B u skladu sa Direktivom 2014/53/EU. Kompletan tekst EU izjave o usklađenosti nalazi se na sledećoj internet adresi:

<http://continental.automotive-approvals.com/>

Frekventijski pojasi u kojima radio oprema radi:

76–77 GHz

Maksimalna snaga radio-frekvencije preneti u frekventijskim pojasi u kojima radio oprema radi:

2.0W (33 dBm RMS EIRP)

Serbian models

Hands-Free Telephone System

**Panasonic**

**EU Declaration of Conformity**  
Document Number: PAS-200030-02

**Manufacturer**

Name : Panasonic Corporation  
Address : 4261Ikonohe-cho, Tsuzuki-ku, Yokohama-shi, Kanagawa-ken,224-8530, Japan

**Object of Declaration** < A >

Product Name : CAR AUDIO(UNIT ASSY DA)  
Trade Name : Panasonic  
Model Number : CA-9H18E1UT; CA-9H18E0UT; CL-MH1AE4JT; CL-MH18K3JT; CL-MH2CE1AD; CL-MH2E2AD; CL-MH2CE3AD; CL-MH2CE4AD; CL-MH2CE5AD; CL-MH2CE6AD; CL-MH2CE7AD; CL-MH2CE8AD; CL-MH5BE1AD; CL-MH5BE2AD; CL-MH5BE3AD  
Model ID : AH2001

**CE Requirements**

This declaration of conformity is issued under the sole responsibility of the manufacturer. The object of the declaration described above is in conformity with the requirements of the following EU legislation and harmonized standards:

Council Directive : 2014/53/EU RED < B >

Applicable Standards < C >

EN 62311:2008  
EN 62368-1:2014+A11:2017  
EN 301 489-1 V2.1.1:2017  
EN 301 489-3 V2.1.1:2017  
EN 301 489-17 V3.1.1:2017  
EN 301 489-19 V2.1.0:2017  
EN 300 328 V2.2.2:2019  
EN 301 893 V2.1.1:2017  
EN 300 440 V2.1.1:2017  
EN 303 413 V1.1:2017

Notified Body : MCOM Labs Inc., Notified Body Number 2280, performed assessment of the tests and the technical documentation provided by the applicant with the essential requirements of the RED 2014/53/EU, and issued EU-TYPE EXAMINATION CERTIFICATE DEKR242 / 15 Apr 2021 / Rev.C.

**Additional Information** < D >

24.06.2021   
Date of Issue / Signature  
Osamu Ishikawa / manager  
Printed Name / Title

24 Jun 2021   
Date of Issue / Signature  
Niels Erdmann  
Authorized Representative

~Authorized Representative~  
Panasonic Testing Centre, Panasonic Marketing Europe GmbH  
Winsbergstr 15, 22525 Hamburg, Germany

**Panasonic**

**EU Declaration of Conformity**  
Document Number: PAS-230096-01

**Manufacturer**

Name : Panasonic Corporation  
Address : 4261Ikonohe-cho, Tsuzuki-ku, Yokohama-shi, Kanagawa-ken,224-8520, Japan

**Object of Declaration** < A >

Product Name : CAR AUDIO(UNIT ASSY DA)  
Trade Name : Panasonic  
Model Number : CL-MH2DE0AD; CL-MH2DE2AD; CL-MH2DE3AD; CL-MH2CE4AD  
Model ID : AH2001

**CE Requirements**

This declaration of conformity is issued under the sole responsibility of the manufacturer. The object of the declaration described above is in conformity with the requirements of the following EU legislation and harmonized standards:

Council Directive : 2014/53/EU RED < B >

Applicable Standards < C >

EN 62311:2008  
EN 62368-1:2014+A11:2017  
EN 301 489-1 V2.1.1:2017  
EN 301 489-3 V2.1.1:2017  
EN 301 489-17 V3.1.1:2017  
EN 301 489-19 V2.1.0:2017  
EN 300 328 V2.2.2:2019  
EN 301 893 V2.1.1:2017  
EN 300 440 V2.1.1:2017  
EN 303 413 V1.1:2017

Notified Body : MCOM Labs Inc., Notified Body Number 2280, performed assessment of the tests and technical documentation provided by the applicant with the essential requirements of the RED 2014/53/EU, and issued EU-TYPE EXAMINATION CERTIFICATE DEKR249 / 26 Jan 2022 / Rev.A.

**Additional Information** < D >

07.03.2022   
Date of Issue / Signature  
Kei Hatsuoka / manager  
Printed Name / Title

07.03.2022   
Date of Issue / Signature  
Wolfram Kühn  
Authorized Representative

Information

## Serbian models

## Hands-Free Telephone System

## Telematics Control Unit

**Panasonic**EU Declaration of Conformity  
Document Number: PAS-210015-01

## Manufacturer

Name : Panasonic Corporation  
Address : 4261Konoba-cho, Suzuki-ku, Yokohama-shi, Kanagawa-ken,224-8520, Japan

## Object of Declaration

&lt; A &gt;

Product Name : CAR AUDIO(UNIT ASSY DA)  
Trade Name : Panasonic  
Model Number : CL-MH2CE9AD; CL-MH2CE9AD; CL-MH4AXD05; CL-MH4BE1JR; CL-MH4BE2JR  
CL-MH4BE3JR; CL-MH4BE4JR; CL-MH4BE5JR; CL-MH4BE6JR; CL-MH4BE7JR  
CL-MH4BE8JR; CL-MH4BE9JR; CL-MH4BEA1R; CL-MH4BE1R  
Model ID : AH2001

## CE Requirements

This declaration of conformity is issued under the sole responsibility of the manufacturer. The object of the declaration described above is in conformity with the requirements of the following EU legislation and harmonized standards:

Council Directive : 2014/53/EU RED < B >  
Applicable Standards : EN 62311:2008 < C >  
EN 62368-1:2014 +A11:2017  
EN 301 489-1 V2.1.1:2017  
EN 301 489-3 V2.1.1:2017  
EN 301 489-17 V3.1.1:2017  
EN 301 489-19 V1.0:2017  
EN 300 328 V2.2:2019  
EN 301 893 V2.1.1:2017  
EN 300 440 V2.1.1:2017  
EN 303 413 V1.1.1:2017  
Notified Body : MICOM Labs Inc., Notified Body Number 2280, performed assessment of the tests and the technical documentation provided by the applicant with the essential requirements of the RED 2014/53/EU, and issued EU-TYPE EXAMINATION CERTIFICATE DENR242 / 15-Apr-2021 / Rev.C.

## Additional Information

&lt; D &gt;

15.06.2021

Date of Issue / Signature

Osamu Ishikawa / manager  
Printed Name / Title

22.Jun.2021

Date of Issue / Signature

Niels Erdmann

Authorised Representative

- Authorised Representative -  
Panasonic Testing Centre, Panasonic Marketing Europe GmbH  
Winsbergring 15, 22525 Hamburg, Germany

Овиме, DENSO CORPORATION изјављује да је радио опрема тип усаглашена са Директивом 2014/53/EU. Цео текст ЕУ декларације о усаглашености доступам је на следећој интернет адреси:  
<https://www.denso.com/global/en/contact-us/doc/>

Serbian models

Digital Key



Akcionarsko društvo za ispitivanje kvaliteta KVALITET NS  
Акционарско друштво за испитивање квалитета КВАЛИТЕТ НС  
Joint-stock company for quality testing KVALITET NS



**ПОТВРДА О УСАГЛАШЕНОСТИ - РИТТО** Број: П1623146400  
**CONFIRMATION OF CONFORMITY - R&TTE** No:

**Подносилац захтева:** RITTE CONSULTING DOO  
**Applicant:** RITTE CONSULTING DOO  
11000 БЕОГРАД-РАКОВИЦА  
КНЕЗА ВИСЕЛАВА 63/2

**Врста опреме:** SISTEM ZA DALJINSKI PRISTUP VOZILU  
**Equipment category:**

**Ознака типа/модела:** A2C775684  
**Equipment type/model:**

**Робна марка:** Continental  
**Equipment trademark:**

**Произвођач:** Continental Automotive Technologies GmbH  
**Manufacturer:** NEMAČKA

**Вреднована документација:** Evaluated documentation:  
**Лабораторија/испитни извештај:** 29.08.2022./  
**Laboratory/ Test report:** EMK/EMC: EMV TESTHAUS GmbH.; 190900-AU02+E01, 06.11.2019./  
RITTE/R&TTE: TÜV SÜD PSB Plc Ltd.; 7191259235-ECC21/01 Issue: 01, 16.03.2021/

На основу горе наведене документације утврђено је да горе наведена опрема одговара захтеву Правилника о радио опреми и телекомуникационој терминосној опреми (СД, гласник РС, 102/12).

On the basis of the above mentioned documentation it is found that above mentioned equipment fulfils the requirements of the Radiobook on Radio Equipment and Telecommunications Terminal Equipment (Official Gazette RS, 102/12).

Настале промене у спецификацији, типу/моделу, компонентама, електричним карактеристикама опреме који утичу на усаглашеност са наведеним Правилником могуће се пријавити "Квалитет"-у и.д. Наси.

Any changes in the specification, product, components of the design, electrical characteristics which may influence its conformity to the above mention Radiobook, shall be forwarded to "Kvalitet".

Право издавања Потврде за наведену опрему: 09.09.2020. Број Потврде: П162018300

**Место и датум издавања:** Важи до:  М.П. **Генерални директор**  
**Place and date:** Valid until:  **Владимир Букачински, дипл.инж.**  
Ниш, 07.09.2023. 06.09.2026. **Seal.**



Овај документ важи само за производе који су истоветни са производима који су били предмет вредновања.  
Београд, Светозар Цара Константина 82-86, Ниш 11000, Србија. Тел: (018)550-766, 550-624, 550-058  
office@kvalitet.co.rs, http://www.kvalitet.co.rs

Serbian models

Wireless Charger



**KVALITET**  
AGENCIJA ZA IZBOR ZA NEKRETNOST KVALITET NS  
Агенција за избор за некретност КВАЛИТЕТ ННС  
Agency for quality testing KVALITET NS

**POTVRDA O USAGLAŠENOSTI - РПГ 10**      Број: **P1622106300**  
CONFIRMATION OF CONFORMITY - RB7TE      №:

**Podnosioca izjava:**    **RITE CONSULTING DOO**  
Адреса:                    **11000 BEOGRAD, KACSKOVA  
KNEZA BRADISAVLJA 696/2**

**Врста опреме:**        **BEZICNI PUNJAC**  
Вид опреме (category):

**Основа типификација:**    **WCS00102121**  
Базисна типификација:

**Робна марка:**        **SHYVS Co., Ltd.**  
Својиник (brand):

**Произвођач:**        **SHYVS Co., Ltd.**  
Произвођач (manufacturer):

**Внедрена документација:**    **Evolution document3001**

**Лабелаторија/**                    **Besicna Safety, Kome-Scora Co., Ltd. 49855, 10 00392 / DTAD Co. Ltd. 04112, 12296-**  
**контакт информације:**                    **0304, 20 20 2022**



**Датум изјаве:**                    **SHYVS ETAC Co., Ltd. (DRCES2200-0029, 15.06.2022)**

**Тест изјаве:**                    **RITtoRB7TE DTAD Co. Ltd. (DTCET2026 0275, 14.06.2022)**

На основу техничких документације утврђено је да описана опрема одговара захтевима Правилника о издавању одобрења и техничким спецификацијским условима из области EMC, укључујући РС 19502. Циљ ове изјаве је да се потврди да описана опрема задовољава захтеве EMC, укључујући РС 19502, на основу техничких документација, тестовања, контролних процедура и резултата тестова. Ова изјава не представља гаранцију или одговорност произвођача или тестера. Ова изјава је валидна само ако се користи са свим потребним додатним документацијом.

**Место и датум издавања:**                    **Београд**                    **07.07.2022.**

**Place and date:**                    **Belgrade**                    **07.07.2022.**

Овај документ важи само за произвођача или за оне на чије име је издат и који су обавезани да придржавају  
Београд, Школовачка 69/2, 11000 Београд, Србија. Контакт: 011 2600 196, 20204, 20205, 20206, 20207, 20208, 20209, 20210, 20211, 20212, 20213, 20214, 20215, 20216, 20217, 20218, 20219, 20220, 20221, 20222, 20223, 20224, 20225, 20226, 20227, 20228, 20229, 20230, 20231, 20232, 20233, 20234, 20235, 20236, 20237, 20238, 20239, 20240, 20241, 20242, 20243, 20244, 20245, 20246, 20247, 20248, 20249, 20250, 20251, 20252, 20253, 20254, 20255, 20256, 20257, 20258, 20259, 20260, 20261, 20262, 20263, 20264, 20265, 20266, 20267, 20268, 20269, 20270, 20271, 20272, 20273, 20274, 20275, 20276, 20277, 20278, 20279, 20280, 20281, 20282, 20283, 20284, 20285, 20286, 20287, 20288, 20289, 20290, 20291, 20292, 20293, 20294, 20295, 20296, 20297, 20298, 20299, 20300, 20301, 20302, 20303, 20304, 20305, 20306, 20307, 20308, 20309, 20310, 20311, 20312, 20313, 20314, 20315, 20316, 20317, 20318, 20319, 20320, 20321, 20322, 20323, 20324, 20325, 20326, 20327, 20328, 20329, 20330, 20331, 20332, 20333, 20334, 20335, 20336, 20337, 20338, 20339, 20340, 20341, 20342, 20343, 20344, 20345, 20346, 20347, 20348, 20349, 20350, 20351, 20352, 20353, 20354, 20355, 20356, 20357, 20358, 20359, 20360, 20361, 20362, 20363, 20364, 20365, 20366, 20367, 20368, 20369, 20370, 20371, 20372, 20373, 20374, 20375, 20376, 20377, 20378, 20379, 20380, 20381, 20382, 20383, 20384, 20385, 20386, 20387, 20388, 20389, 20390, 20391, 20392, 20393, 20394, 20395, 20396, 20397, 20398, 20399, 20400, 20401, 20402, 20403, 20404, 20405, 20406, 20407, 20408, 20409, 20410, 20411, 20412, 20413, 20414, 20415, 20416, 20417, 20418, 20419, 20420, 20421, 20422, 20423, 20424, 20425, 20426, 20427, 20428, 20429, 20430, 20431, 20432, 20433, 20434, 20435, 20436, 20437, 20438, 20439, 20440, 20441, 20442, 20443, 20444, 20445, 20446, 20447, 20448, 20449, 20450, 20451, 20452, 20453, 20454, 20455, 20456, 20457, 20458, 20459, 20460, 20461, 20462, 20463, 20464, 20465, 20466, 20467, 20468, 20469, 20470, 20471, 20472, 20473, 20474, 20475, 20476, 20477, 20478, 20479, 20480, 20481, 20482, 20483, 20484, 20485, 20486, 20487, 20488, 20489, 20490, 20491, 20492, 20493, 20494, 20495, 20496, 20497, 20498, 20499, 20500, 20501, 20502, 20503, 20504, 20505, 20506, 20507, 20508, 20509, 20510, 20511, 20512, 20513, 20514, 20515, 20516, 20517, 20518, 20519, 20520, 20521, 20522, 20523, 20524, 20525, 20526, 20527, 20528, 20529, 20530, 20531, 20532, 20533, 20534, 20535, 20536, 20537, 20538, 20539, 20540, 20541, 20542, 20543, 20544, 20545, 20546, 20547, 20548, 20549, 20550, 20551, 20552, 20553, 20554, 20555, 20556, 20557, 20558, 20559, 20560, 20561, 20562, 20563, 20564, 20565, 20566, 20567, 20568, 20569, 20570, 20571, 20572, 20573, 20574, 20575, 20576, 20577, 20578, 20579, 20580, 20581, 20582, 20583, 20584, 20585, 20586, 20587, 20588, 20589, 20590, 20591, 20592, 20593, 20594, 20595, 20596, 20597, 20598, 20599, 20600, 20601, 20602, 20603, 20604, 20605, 20606, 20607, 20608, 20609, 20610, 20611, 20612, 20613, 20614, 20615, 20616, 20617, 20618, 20619, 20620, 20621, 20622, 20623, 20624, 20625, 20626, 20627, 20628, 20629, 20630, 20631, 20632, 20633, 20634, 20635, 20636, 20637, 20638, 20639, 20640, 20641, 20642, 20643, 20644, 20645, 20646, 20647, 20648, 20649, 20650, 20651, 20652, 20653, 20654, 20655, 20656, 20657, 20658, 20659, 20660, 20661, 20662, 20663, 20664, 20665, 20666, 20667, 20668, 20669, 20670, 20671, 20672, 20673, 20674, 20675, 20676, 20677, 20678, 20679, 20680, 20681, 20682, 20683, 20684, 20685, 20686, 20687, 20688, 20689, 20690, 20691, 20692, 20693, 20694, 20695, 20696, 20697, 20698, 20699, 20700, 20701, 20702, 20703, 20704, 20705, 20706, 20707, 20708, 20709, 20710, 20711, 20712, 20713, 20714, 20715, 20716, 20717, 20718, 20719, 20720, 20721, 20722, 20723, 20724, 20725, 20726, 20727, 20728, 20729, 20730, 20731, 20732, 20733, 20734, 20735, 20736, 20737, 20738, 20739, 20740, 20741, 20742, 20743, 20744, 20745, 20746, 20747, 20748, 20749, 20750, 20751, 20752, 20753, 20754, 20755, 20756, 20757, 20758, 20759, 20760, 20761, 20762, 20763, 20764, 20765, 20766, 20767, 20768, 20769, 20770, 20771, 20772, 20773, 20774, 20775, 20776, 20777, 20778, 20779, 20780, 20781, 20782, 20783, 20784, 20785, 20786, 20787, 20788, 20789, 20790, 20791, 20792, 20793, 20794, 20795, 20796, 20797, 20798, 20799, 20800, 20801, 20802, 20803, 20804, 20805, 20806, 20807, 20808, 20809, 20810, 20811, 20812, 20813, 20814, 20815, 20816, 20817, 20818, 20819, 20820, 20821, 20822, 20823, 20824, 20825, 20826, 20827, 20828, 20829, 20830, 20831, 20832, 20833, 20834, 20835, 20836, 20837, 20838, 20839, 20840, 20841, 20842, 20843, 20844, 20845, 20846, 20847, 20848, 20849, 20850, 20851, 20852, 20853, 20854, 20855, 20856, 20857, 20858, 20859, 20860, 20861, 20862, 20863, 20864, 20865, 20866, 20867, 20868, 20869, 20870, 20871, 20872, 20873, 20874, 20875, 20876, 20877, 20878, 20879, 20880, 20881, 20882, 20883, 20884, 20885, 20886, 20887, 20888, 20889, 20890, 20891, 20892, 20893, 20894, 20895, 20896, 20897, 20898, 20899, 20900, 20901, 20902, 20903, 20904, 20905, 20906, 20907, 20908, 20909, 20910, 20911, 20912, 20913, 20914, 20915, 20916, 20917, 20918, 20919, 20920, 20921, 20922, 20923, 20924, 20925, 20926, 20927, 20928, 20929, 20930, 20931, 20932, 20933, 20934, 20935, 20936, 20937, 20938, 20939, 20940, 20941, 20942, 20943, 20944, 20945, 20946, 20947, 20948, 20949, 20950, 20951, 20952, 20953, 20954, 20955, 20956, 20957, 20958, 20959, 20960, 20961, 20962, 20963, 20964, 20965, 20966, 20967, 20968, 20969, 20970, 20971, 20972, 20973, 20974, 20975, 20976, 20977, 20978, 20979, 20980, 20981, 20982, 20983, 20984, 20985, 20986, 20987, 20988, 20989, 20990, 20991, 20992, 20993, 20994, 20995, 20996, 20997, 20998, 20999, 21000, 21001, 21002, 21003, 21004, 21005, 21006, 21007, 21008, 21009, 21010, 21011, 21012, 21013, 21014, 21015, 21016, 21017, 21018, 21019, 21020, 21021, 21022, 21023, 21024, 21025, 21026, 21027, 21028, 21029, 21030, 21031, 21032, 21033, 21034, 21035, 21036, 21037, 21038, 21039, 21040, 21041, 21042, 21043, 21044, 21045, 21046, 21047, 21048, 21049, 21050, 21051, 21052, 21053, 21054, 21055, 21056, 21057, 21058, 21059, 21060, 21061, 21062, 21063, 21064, 21065, 21066, 21067, 21068, 21069, 21070, 21071, 21072, 21073, 21074, 21075, 21076, 21077, 21078, 21079, 21080, 21081, 21082, 21083, 21084, 21085, 21086, 21087, 21088, 21089, 21090, 21091, 21092, 21093, 21094, 21095, 21096, 21097, 21098, 21099, 21100, 21101, 21102, 21103, 21104, 21105, 21106, 21107, 21108, 21109, 21110, 21111, 21112, 21113, 21114, 21115, 21116, 21117, 21118, 21119, 21120, 21121, 21122, 21123, 21124, 21125, 21126, 21127, 21128, 21129, 21130, 21131, 21132, 21133, 21134, 21135, 21136, 21137, 21138, 21139, 21140, 21141, 21142, 21143, 21144, 21145, 21146, 21147, 21148, 21149, 21150, 21151, 21152, 21153, 21154, 21155, 21156, 21157, 21158, 21159, 21160, 21161, 21162, 21163, 21164, 21165, 21166, 21167, 21168, 21169, 21170, 21171, 21172, 21173, 21174, 21175, 21176, 21177, 21178, 21179, 21180, 21181, 21182, 21183, 21184, 21185, 21186, 21187, 21188, 21189, 21190, 21191, 21192, 21193, 21194, 21195, 21196, 21197, 21198, 21199, 21200, 21201, 21202, 21203, 21204, 21205, 21206, 21207, 21208, 21209, 21210, 21211, 21212, 21213, 21214, 21215, 21216, 21217, 21218, 21219, 21220, 21221, 21222, 21223, 21224, 21225, 21226, 21227, 21228, 21229, 21230, 21231, 21232, 21233, 21234, 21235, 21236, 21237, 21238, 21239, 21240, 21241, 21242, 21243, 21244, 21245, 21246, 21247, 21248, 21249, 21250, 21251, 21252, 21253, 21254, 21255, 21256, 21257, 21258, 21259, 21260, 21261, 21262, 21263, 21264, 21265, 21266, 21267, 21268, 21269, 21270, 21271, 21272, 21273, 21274, 21275, 21276, 21277, 21278, 21279, 21280, 21281, 21282, 21283, 21284, 21285, 21286, 21287, 21288, 21289, 21290, 21291, 21292, 21293, 21294, 21295, 21296, 21297, 21298, 21299, 21300, 21301, 21302, 21303, 21304, 21305, 21306, 21307, 21308, 21309, 21310, 21311, 21312, 21313, 21314, 21315, 21316, 21317, 21318, 21319, 21320, 21321, 21322, 21323, 21324, 21325, 21326, 21327, 21328, 21329, 21330, 21331, 21332, 21333, 21334, 21335, 21336, 21337, 21338, 21339, 21340, 21341, 21342, 21343, 21344, 21345, 21346, 21347, 21348, 21349, 21350, 21351, 21352, 21353, 21354, 21355, 21356, 21357, 21358, 21359, 21360, 21361, 21362, 21363, 21364, 21365, 21366, 21367, 21368, 21369, 21370, 21371, 21372, 21373, 21374, 21375, 21376, 21377, 21378, 21379, 21380, 21381, 21382, 21383, 21384, 21385, 21386, 21387, 21388, 21389, 21390, 21391, 21392, 21393, 21394, 21395, 21396, 21397, 21398, 21399, 21400, 21401, 21402, 21403, 21404, 21405, 21406, 21407, 21408, 21409, 21410, 21411, 21412, 21413, 21414, 21415, 21416, 21417, 21418, 21419, 21420, 21421, 21422, 21423, 21424, 21425, 21426, 21427, 21428, 21429, 21430, 21431, 21432, 21433, 21434, 21435, 21436, 21437, 21438, 21439, 21440, 21441, 21442, 21443, 21444, 21445, 21446, 21447, 21448, 21449, 21450, 21451, 21452, 21453, 21454, 21455, 21456, 21457, 21458, 21459, 21460, 21461, 21462, 21463, 21464, 21465, 21466, 21467, 21468, 21469, 21470, 21471, 21472, 21473, 21474, 21475, 21476, 21477, 21478, 21479, 21480, 21481, 21482, 21483, 21484, 21485, 21486, 21487, 21488, 21489, 21490, 21491, 21492, 21493, 21494, 21495, 21496, 21497, 21498, 21499, 21500, 21501, 21502, 21503, 21504, 21505, 21506, 21507, 21508, 21509, 21510, 21511, 21512, 21513, 21514, 21515, 21516, 21517, 21518, 21519, 21520, 21521, 21522, 21523, 21524, 21525, 21526, 21527, 21528, 21529, 21530, 21531, 21532, 21533, 21534, 21535, 21536, 21537, 21538, 21539, 21540, 21541, 21542, 21543, 21544, 21545, 21546, 21547, 21548, 21549, 21550, 21551, 21552, 21553, 21554, 21555, 21556, 21557, 21558, 21559, 21560, 21561, 21562, 21563, 21564, 21565, 21566, 21567, 21568, 21569, 21570, 21571, 21572, 21573, 21574, 21575, 21576, 21577, 21578, 21579, 21580, 21581, 21582, 21583, 21584, 21585, 21586, 21587, 21588, 21589, 21590, 21591, 21592, 21593, 21594, 21595, 21596, 21597, 21598, 21599, 21600, 21601, 21602, 21603, 21604, 21605, 21606, 21607, 21608, 21609, 21610, 21611, 21612, 21613, 21614, 21615, 21616, 21617, 21618, 21619, 21620, 21621, 21622, 21623, 21624, 21625, 21626, 21627, 21628, 21629, 21630, 21631, 21632, 21633, 21634, 21635, 21636, 21637, 21638, 21639, 21640, 21641, 21642, 21643, 21644, 21645, 21646, 21647, 21648, 21649, 21650, 21651, 21652, 21653, 21654, 21655, 21656, 21657, 21658, 21659, 21660, 21661, 21662, 21663, 21664, 21665, 21666, 21667, 21668, 21669, 21670, 21671, 21672, 21673, 21674, 21675, 21676, 21677, 21678, 21679, 21680, 21681, 21682, 21683, 21684, 21685, 21686, 21687, 21688, 21689, 21690, 21691, 21692, 21693, 21694, 21695, 21696, 21697, 21698, 21699, 21700, 21701, 21702, 21703, 21704, 21705, 21706, 21707, 21708, 21709, 21710, 21711, 21712, 21713, 21714, 21715, 21716, 21717, 21718, 21719, 21720, 21721, 21722, 21723, 21724, 21725, 21726, 21727, 21728, 21729, 21730, 21731, 21732, 21733, 21734, 21735, 21736, 21737, 21738, 21739, 21740, 21741, 21742, 21743, 21744, 21745, 21746, 21747, 21748, 21749, 21750, 21751, 21752, 21753, 21754, 21755, 21756, 21757, 21758, 21759, 21760, 21761, 21762, 21763, 21764, 21765, 21766, 21767, 21768, 21769, 21770, 21771, 21772, 21773, 21774

Serbian models

Blind Spot Information System/Cross Traffic Monitor



Postal address: Peter-Dornier-Strasse 10, 88131 Lindau, Germany  
Manufacturer name: ADC Automotive Distance Control Systems GmbH  
Importer Name: Delta Automoto d.o.o.  
Postal address: OMLADINSKIH BRIGADA 33A, 11070 NOVI BEOGRAD, SERBIA

**Ovim, ADC Automotive Distance Control Systems GmbH izjavljuje da je tip radio opreme SRR5-B u skladu sa Direktivom 2014/53/EU. Kompletan tekst EU izjave o usklađenosti nalazi se na sledećoj internet adresi:**

**<http://continental.automotive-approvals.com/>**

**Frekvencijski pojasi u kojima radio oprema radi:  
76–77 GHz**

**Maksimalna snaga radio-frekvencije prenetu u frekvencijskim pojasima u kojima radio oprema radi:  
1.58W (32dBm RMS EIRP)**

Ukrainian models

BCM  
Keyless Access System



Postal address:  
Siemensstrasse 12  
D-93055 Regensburg  
Germany  
Manufacturer name:  
Continental Automotive GmbH  
Frequency band: 125KHz  
Maximum transmitted output: 10mW  
Importer Name:  
Pride Motor LLC  
Postal address:  
73, Lesi Ukrainky Str., Vyshneve, Kyiv oblast, 08132, Ukraine

**ДЕКЛАРАЦІЯ ПРО ВІДПОВІДНІСТЬ**

1. Раціоналізація: Пристрій серійного радіуса дії (примітка 433-MHz), NFC, індукції, який використовує частоту 125 КГц.

2. ТОВ «Нормакс-Україна» (с/бс 314, вул. Крива 139, м. Мелітополь, Закарпатська обл., 72319, Україна, код ЄДРПОУ 37463108)  
*Виконавчий орган з питань відповідності або його уповноваженого представника*

3. Ця декларація відповідності виходить від особи, уповноваженої виробником.

4. Об'єкт декларації  
Назва об'єкта: Модуль об'єднаного контролера автомобіля (Integrated Body Controller);  
Модель: 41580430;  
Промислова марка: «Continental»;  
Виробник: «Continental Automotive GmbH» (Siemensstrasse 12, D-93055 Regensburg, Germany) / «Юнтінентал Аутомотів ГмбХ» (Сіменсштрассе 12, D-93055 Регенсбург, Німеччина);  
Місце виробництва: «Continental Automotive Changshu Co., Ltd.» (Changshu Branch, 5800 Shengda Street, 130000, Changshu, Jilin P.R. China) / «Юнтінентал Аутомотів Манчжура Ко., Лтд.» (Дачунгуче Ерочу, 5800 Шангтай Стріт, 130000, Чаншунь, Дачунгуче П.Р. Корея); «CONTINENTAL AUTOMOTIVE GUADALAJARA MEXICO S DE RL DE CV» (Сітено а ла Тієра No. 3, К.м. 3.5 Сарабана (Guadalupe Mexico), Сітено ла Тієра, 4560 Тієррото де Зайла, Халіско, Мексика) / «ЮНТІНЕНТАЛ АУТОМОТІВ ГУАДАЛАХАРА МЕКІКО С ДЕ РЛ ДЕ СВ» (Кантон а ла Тієра No.3, К.м. 3.5 Карретея Гуадалупара Мексика, Колонія ла Тієра, 4560 Тієррото де Зайла, Халіско, Мексика);  
Нижче наведено серійний номер: **продукування відповідності серії**.

5. Об'єкт декларації відповідає вимогам «Технічного регламенту радіоелектроніки», затвердженого постановою Кабінету Міністрів України від 24.05.2017р. № 355

6. Стандарти з переліку технічних стандартів, що були застосовані, та інші стандарти і технічні специфікації, щодо яких декларується відповідність:

*з вимог (розділ 6 технічного регламенту):*  
 ETSI EN 63366-1:2017 (EN 63366-1:2014; AC:2015-02; AC:2015-02; AC:2015-11; AC:2017; A11:2017; IDT; IEC 62368-1:2014; MOD; CEN 12014; CEN 2:2015; IDT);  
 ETSI EN 62479-2015 (EN 62479:2010; IDT; EN 50665:2017);  
 з електричних стандартів (розділ 6 технічного регламенту):  
 ETSI EN 301 489-1:2014 (EN 301 489-1 V1.9.2, IDT);  
 ETSI EN 301 489-2:2009 (EN 301 489-2:2002; IDT);  
 об'єктом виступає розроблений ресурс (розділ 7 технічного регламенту):  
 ETSI EN 300 220-2:2017 (ETSI EN 300 220-2:2017; IDT);  
 ETSI EN 300 220-1:2014 (ETSI EN 300 220-1:2017; IDT);  
 ETSI EN 300 330-2018 (ETSI EN 300 330:2017; IDT).

*із технічного регламенту кодування, перелік на його вимоги*

7. Присвоєний орган з питань відповідності: **ОВН «Орбон сертифицишнл Центр сертїфікацїї інтеграцїї на виробствї» (В.І. Т.К.02)**  
*(національний інтеграційний орган з питань відповідності)*

Висновки роботи з оцінки відповідності за процедурою експертизи типу (Модуль В)  
*(об'єкт-модуль типу В)*

та висновки експертизи типу за Ц.М.02.С.1 і М.07-01 від 03 серпня 2020 р.  
*(з дані технічного регламенту розділу з оцінки відповідності)*

8. Додаткова інформація:  
Підписано від імені та за довіром, дорученням № 20180503 від 03.05.2018 р. «Continental Automotive GmbH» (Siemensstrasse 12, D-93055 Regensburg, Germany) уповноваженим представником в Україні ТОВ «Нормакс-Україна»  
м. Мелітополь, Україна  
03 серпня 2020 р.  
*(оскільки він єдиний підпис)*

Директор  
ТОВ «Нормакс-Україна»

О. В. Шелест  
Власник та керівник  
ТОВ «Нормакс-Україна»  
Л.П. 020-21-88887-00  
12019 074 001 00000

Information

Ukrainian models

FOB  
Keyless Access System



Postal address:  
Siemensstrasse 12  
D-93055 Regensburg  
Germany  
Manufacturer name:  
Continental Automotive GmbH  
Frequency band: 433.92MHz  
Maximum transmitted output: 1mW  
Importer Name:  
Pride Motor LLC  
Postal address:  
73, Lesi Ukrainsky Str., Vyshneve, Kyiv oblast, 08132, Ukraine

Information

**ДЕКЛАРАЦІЯ ПРО ВІДПОВІДНІСТЬ**

1. Радіобудівник: Пристрій короткого радіусу дії (433 МГц, RFID (пасивний)).  
*(виробл. елект. мотором машин на європейському ринку)*

2. ТОВ «Нормекс-Україна» (офіс 314, вул. Кірова 139, м. Мелітополь, Запорізька обл., 72319, Україна, код ЄДРПОУ 37463166).  
*(власником та/або виробником або його уповноваженою особою)*

3. Це адекватне відношення викона під особисту відповідальність виробника.

4. Об'єкт декларації:  
Назва обладнання: Високочастотний радіо (Radio Frequency Transmitter / Honda MY21);  
Модель: TR-4;  
Головний завод: «Самітбайт»;  
Директор: «Самітбайт Автомобілі GmbH» (Семтсштрассе 12, D-93055 Regensburg, Germany) / «Континентал Автомобіл ГмбХ» (Семтсштрассе 12, D-93055 Регенсбург, Німеччина);  
Мале підприємство: «Самітбайт Автомобілі Шанхай Сін, Лід» (Шанхай Бічшань 5800 Shanghai Street, 20000, Shanghai, Шан П. Р. Китай) / «Континентал Автомобіл Чанчунь Ко., Лтд.» (Данчжоу Юресс, 5800 Шенхай Сіті, 330000, Чанчунь, Дзялін П. Р. Китай); «CONTINENTAL AUTOMOTIVE GLOBALAJARA MEXICO S DE RL DE CV» (Camino a la Tierra No. 2, Km. 1.5 Caminos Guadalupe Montea, Colonia La Tierra, 46460 Tlaximilco de Zedillo, Jalisco, Mexico) / «CONTINENTAL AUTOMOTIVE GUADAJALARA MEXICO S DE RL DE CV» (Carretera a la Tierra No. 3, Km. 3.5 Carretera Guadalupe Montea, Colonia La Tierra, 46460 Tlaximilco de Zedillo, Jalisco, Mexico);  
*(виробл. машин або окремих компонентів, призначених для використання в машині);*

5. Об'єкт декларації відповідає вимогам «Технічних регламенту радіобудівників», затвердженого постановою Кабінету Міністрів України від 24.08.2017р. № 355.

6. Стандарти з переліку національних стандартів, що були застосовані, та інші стандарти з переліку спеціфікацій, щодо яких декларується відповідність:  
з Європейським (європейським) регламентами:  
DСТУ EN 62368-1:2017 (EN 62368-1:2014, AC:2014-05, AC:2015-02, AC:2015-11, AC:2017, A11:2017, IDT, EN 62368-1:2014, M001 Єв-2014 Сое-7:2014, IDT);  
DСТУ EN 62479-2015 (EN 62479:2010, IDT), EN 50663: 2017;  
з міжнародними стандартами (применіть до технічних регламентів):  
DСТУ EN 301 489-1:2014 (EN 301 489-1 V1.9.2, IDT);  
DСТУ EN 301 489-3:2009 (ETSI EN 301 489-3:2002, IDT),  
орієнтовані на використання радіочастотного ресурсу (применіть до технічних регламентів):  
DСТУ EN 300 220-2:2017 (ETSI EN 300 220-2:2017, IDT),  
DСТУ EN 300 220-1:2018 (ETSI EN 300 220-1:2017, IDT),  
DСТУ EN 300 330:2018 (ETSI EN 300 330:2017, IDT)  
*(зі стандартів відповідальності виробника машини відповідно до вимог ДСТУ EN 134, TR 612)*

7. Прозначений орган з технічної відповідності FOB «Орган сертифікації «Центр сертифікації матеріалів на європейському ринку» (ЄС UA, TR 612)  
*(власником спеціалізованої лабораторії з розробкою сертифікації)*

Виконав роботу з оцінки відповідності за принципом еквівалентності типу (Модель В)  
*(дата виконання тесту: 08)*

та/або сертифікат експертизи типу № UA.032.CT.0319-20 від 02 червня 2020 р.  
*(у разі проведення експертного огляду з метою відповідності)*

8. Діагностична інформація: Процедура версія 010.

Підписати від імені та з повноваженнями № 20180502 від 01.05.2018 р. «Continental Automotive GmbH» (Семтсштрассе 12, D-93055 Regensburg, Germany) уповноваженою особою в Україні ТОВ «Нормекс-Україна»  
м. Мелітополь, Україна  
*(вказати повне ім'я особи)*

02 червня 2020 р.

Директор  
ТОВ «Нормекс-Україна»

**О. В. Шестерін**  
 ТОВ «Нормекс-Україна»  
 UA 032-D-0351-20  
 01.05.2018



Ukrainian models

Hands-Free Telephone System

<https://service.panasonic.ua/>

справжнім Panasonic Automotive Systems Co., Ltd заявляє, що тип радіообладнання \* відповідає Технічному регламенту радіообладнання; повний текст декларації про відповідність доступний на веб-сайті за такою адресою: <https://service.panasonic.ua/> (розділ «Технічне регулювання») моделі; [АН2001]

Postal address:

4261 Ikonobe-cho, Tsuzuki-ku, Yokohama-shi, Kanagawa-ken, 224-8520, Japan

Manufacturer name:

Panasonic Automotive Systems Co., Ltd.

Operational frequency band:

Specifications of Bluetooth

Frequency band: 2402-2480MHz

Specifications of 2.4GHz WLAN

Frequency band: 2412-2472MHz

Maximum Output Power:

Specifications of Bluetooth

Maximum output power: 0.1dBm

Specifications of 2.4GHz WLAN

Maximum output power: 11.9dBm

Importer Name:

Pride Motor LLC

Postal address:

73, Lesi Ukrainky Str., Vyshneve, Kyiv oblast, 08132, Ukraine

**ДЕКЛАРАЦІЯ ПРО ВІДПОВІДНІСТЬ** Panasonic Corporation АН2001

1. Автомобільний аудіопристрій з дисплеєм (UNIT ASSY DA) т.м **Panasonic Corporation** моделі **АН2001** з обладнанням радіодоступу (інтерфейс передачі даних IEEE 802.11 a/b/g/n/ac, IEEE 802.15.1 Bluetooth) та GPS-приймачем.

Радіообладнання (варіаб, тип, номер партії чи серійний номер)

2. Уповноважений представник виробника - ТОВ «Радіо Тест Стандарт» (03115, м. Київ, вул. Львівська, 22А, к. 135, ЄДРПОУ 39205151) діє за дорученням "Panasonic Automotive Systems Co., Ltd.", 4261 Ikonobe-cho, Tsuzuki-ku, Yokohama-shi, Kanagawa-ken 224-8520, Japan.

Найменування та адреса виробника або його уповноваженого представника

3. Ця декларація відповідності видана під особисту відповідальність виробника.

4. Об'єкт декларації (зображення об'єкта декларації для ідентифікації):

Об'єкт декларації (ідентифікація радіообладнання, яке має змогу забезпечити його простежуваність, може включати кольорове зображення у разі потреби для ідентифікації зазначеного радіообладнання)



5. Об'єкт декларації відповідає вимогам Технічного регламенту радіообладнання, затвердженого постановою КМ України від 24.05.2017 № 355.

6. Об'єкт декларації відповідає вимогам наступних НД:

ДСТУ EN 62368-1:2017, IEC 62368-1:2014 (Second Edition), ДСТУ EN 62311:2014, ДСТУ ETSI EN 301 489-1:2019, ETSI EN 301 489-1 V2.1.1 (2017-02), ДСТУ ETSI EN 301 489-3:2009, Final Draft ETSI EN 301 489-3 V2.1.1 (2017-03), ДСТУ ETSI EN 301 489-17:2008, ETSI EN 301 489-17 V2.1.1 (2017-02), ДСТУ ETSI EN 301 489-19:2008, Draft ETSI EN 301 489-19 V2.1.0 (2017-03), ДСТУ EN 55032:2017, EN 55032:2015 + AC:2016, Class B, ДСТУ EN 55035:2019, EN 55035:2017, ДСТУ ETSI EN 300 328:2017, ETSI EN 300 328 V2.2.2, ДСТУ ETSI EN 301 893:2017, ETSI EN 301 893 V2.1.1 (2017-05), ДСТУ ETSI EN 300 440:2018, ETSI EN 300 440 V2.1.1 (2017-03), ДСТУ ETSI EN 309 413:2018, ETSI EN 309 413 V1.1.1 (2017-06)

Посилання на відповідні стандарти з переліку національних стандартів, що були застосовані, або посилання на інші технічні специфікації, якщо між ними декларується відповідність (за зазначенням ідентифікаційного номера, версії та дати видання)

7. Призначений орган з оцінки відповідності:

ООВ УКРЧАСТОТНАГЛЯД, 03179, м. Київ, пр-т Перемоги, 151, реєстр. номер UA.TR.052 за наказом Мінеконпрозвиту України від 11.04.2018 № 500

(найменування, ідентифікаційний номер згідно з реєстром призначених органів)

виконав добровільну оцінку відповідності технічного проекту радіообладнання суттєво вимогам Технічного регламенту радіообладнання, затвердженого постановою КМ України від 24.05.2017 № 355 за процедурою експертизи типу (модуль В) та видав сертифікат експертизи типу № UA.R.TR.052.040-22 від 07 квітня 2022 р.

8. Програмне забезпечення застосовується: Не застосовується. HW: В\_25

У відповідних випадках опис компонентів та аксесуарів, у тому числі програмного забезпечення, зазначених у таблиці, функціонує за призначенням і на них поширюється дія декларації про відповідність



## Ukrainian models

## Hands-Free Telephone System

9. Додаткова інформація: Виробник – «Панасонік Автомобілі Системс Ко., Лтд.», Японія, 4261 Іконобе-чо, Тсузукі-ку, Йокохاما-ші, Канагав-кен 224-8520 ("Panasonic Automotive Systems Co., Ltd.", 4261 Ikonobe-cho, Tsuzuki-ku, Yokohama-shi, Kanagawa-ken 224-8520, Japan) на підприємствах: 1) «Панасонік Автомобілі Системс де Мехіко С.А.», Мехіко, ("Panasonic Automotive Systems de Mexico S.A.", de C.V Carretera Reynosa Mike Allen 1231 S/N Parque Industrial Reynosa Reynosa, Tamaulipas, C.P. 88780, Mexico); 2) «Панасонік Автомобілі Системс Даллан Ко., Лтд.», Ляйай, ("Panasonic Automotive Systems Dallan Co., Ltd.", No.300, Honggang Road, Ganjingzi District Dalian City, Liaoning Province, 116033 P.R. China); 3) «Панасонік Автомобілі Системс Асія Пасіфік Ко., Лтд.», Таїланд, ("Panasonic Automotive Systems Asia Pacific Co., Ltd.", 101 M.2 Terarak Rd., T.Bangsaothong, A.Bangsaothong, Samutprakarn 10570, Thailand); 4) «Панасонік До Брасі Лімітада Руа Матрінгс», Бразилія, ("Panasonic Do Brasil Limitada Rua Matrinçã", 1155 - Distrito Industrial 69075-150 - Manaus - AM Brasil); 5) «Панасонік Корпоресіоні Автомобілі Індустріал Системс Компані Автомобілі Інфотаймент Системс Бізнес Дівісіон Матсумото Сайті», Японія, ("Panasonic Corporation Automotive & Industrial Systems Company Automotive Infotainment Systems Business Division Matsumoto Site", 5652, Sasaga, Matsumoto-shi, Nagano-ken, 399-8730, Japan); 6) «Панасонік Автомобілі Системс Чех, с.р.о.», Чехія, ("Panasonic Automotive Systems Czech, s.r.o.", U Panasonicu 266, Staré Čovice 53006 Pardubice Czech Republic); 7) «Панасонік Тайван Ко., Лтд.», Тайвань, ("Panasonic Taiwan Co., Ltd.", Car Electric Division, PAS Technology Domain Business 579, Yuan Shan Road, Chung-Ho District, New Taipei City, Taiwan); 8) «Панасонік Автомобілі Системс», Малайзія, ("Panasonic Automotive Systems", Malaysia Sdn. Bhd. Plot 10, Phase 4, Prai Industrial Estate, 13600 Prai Penang, Malaysia).
10. Підписано ТОВ «Радіо Тест Стандарт», 03115, м. Київ, вул. Львівська, 22А, к. 135, ЄДРПОУ 39205151 від імені та за дорученням "Panasonic Automotive Systems Co., Ltd.", Японія.

11. Наступне маркування стосується вищезазначеного продукту:



Шуман Д.В.

**Директор ТОВ «Радіо Тест Стандарт»**

(прізвище, ім'я та по батькові, посада)

Декларація взята на облік: **ООВ УКРЧАСТОТНАГЛЛВД**  
03179, м. Київ, пр-т Перемоги, 151; тел. +38 (044) 422-85-44  
**UA.TR.052**

(назва призначеного органу, адреса, ідентифікаційний код реєстру призначеного ООВ)

Обліковий номер: **Звіт про оцінювання № УЧН-22/0.034 від 07.04.2022**

(код для пошуку при реєстрації декларації про відповідність)

Керівник

ООВ УКРЧАСТОТНАГЛЛВД

М.П.



*(підпис)*

*О.Г. Лисенко*

Чинність Декларації можна перевірити в базі даних ООВ УКРЧАСТОТНАГЛЛВД на <http://ucrf.gov.ua>

Декларація взята на облік ООВ УКРЧАСТОТНАГЛЛВД за зверненням Виробника

Ukrainian models

Telematics Control Unit



модель: OGEY10

смуга радіочастот:

GSM900 (Rx: від 925 до 960 МГц)

GSM1800 (Rx: від 1805 до 1880 МГц)

WCDMA Band1 (Rx: від 2110 до 2170 МГц)

WCDMA Band3 (Rx: від 1805 до 1880 МГц)

WCDMA Band8 (Rx: від 925 до 960 МГц)

LTE Band1 (Rx: від 2110 до 2170 МГц)

LTE Band3 (Rx: від 1805 до 1880 МГц)

LTE Band7 (Rx: від 2620 до 2690 МГц)

LTE Band8 (Rx: від 925 до 960 МГц)

LTE Band20 (Rx: від 791 до 821 МГц)

GPS/GALILEO/EGNOS (Rx: 1575.42 МГц)

виробник: DENSO CORPORATION

адреса: 1-1, Showa-cho, Kariya-shi, Aichi-ken, 448-8661 Japan

Імпортер: Pride Motor LLC

адреса: 73, Lesi Ukrainky Str., Vyshneve, Kyiv oblast, 08132, Ukraine

справжнім DENSO CORPORATION заявляє, що тип радіообладнання відповідає Технічному регламенту радіообладнання;

повний текст декларації про відповідність доступний на веб-сайті за такою адресою:

<https://www.denso.com/global/en/contact-us/doc/>



**Ukrainian models**

**Digital Key**

Postal address:  
 Siemensstraße 12, D-93055 Regensburg, Germany  
 Manufacturer name: Continental Automotive Technologies GmbH  
 Operational frequency band:  
 BLE frequency range: 2.402GHz to 2.48GHz  
 Maximum Output Power:  
 BLE Maximum Output Power: +10dBm  
 Importer Name:  
 Ride Motor LLC  
 Postal address:  
 73, Lesi Ukrainsky Str., Vyshneve, Kyiv oblast, 08132, Ukraine

**ДЕКЛАРАЦІЯ ПРО ВІДПОВІДНІСТЬ**

1. Радіозабудованим: **Bluetooth (IEEE Std 802.15.1).**  
(виріб, який випускається на суверенній території)

2. ТОВ «Нормакон-Україна», офіс 314, вул. Крива 139, м. Мелітополь, Запорізька обл., 72319, Україна; код ЄДРПОУ 37463168.  
(випрошувачем або держателем сертифікату ДС. Всі технічні дані прописані в ДС)

3. Ця декларація відповідності видана під особисту відповідальність виробника.

4. Об'єкт декларації:  
 Назва об'єкта: система доступу до транспортного засобу (Smart Access ECU).  
 Модель: АХС75684.  
 Торговельна марка: «CONTINENTAL».  
 Назначення продукції життєвого циклу: 6,5 В - 16 В постійного струму.  
 Виробник: «Continental Automotive GmbH» (Siemensstrasse 12, D-93055 Regensburg, Germany) / «Континентал Аутомотів ГмбХ» (Siemensstrasse 12, D-93055 Regensburg, Німеччина).  
 На підприємстві: «Temic Automotive (Phil.), Inc.» (Bagsakan Road, FTI-Special Economic Zone, Taguig City 1630, Philippines) / «Темік Аутомотів (Філіп.), Інк.» (Багасакан роуд, ФТІАН-Спеціал Економік Зоун, Тагіг Сіті, Філіппіни).  
 Номер партії або серійний номер: продукція виготовляється серійно.  
(визначити рядок об'єкта, який має стосу до об'єкту вказаної в даній таблиці, зазначити відповідальність)

5. Об'єкт декларації відповідає вимогам «Технічного регламенту радіозабудованим», затвердженого постановою Кабінету Міністрів України від 24.05.2017р. № 355.

6. Стандарти з переліку національних стандартів, що були застосовані, та інші стандарти і технічні специфікації, щодо яких декларується відповідність:  
 з безпеки (згідно з технічним регламентом):  
 ДСТУ EN 62368-1:2017 (EN 62368-1:2014; AC:2015-05; AC:2015-02; AC:2015-11; AC:2017; A11:2017; IDT; IEC 62368-1:2014; MOD; Cser 1:2014; Cser 2:2015; IDT);  
 з електричної сумісності (згідно з технічним регламентом):  
 ДСТУ EN 301 489-1:2014 (EN 301 489-1 V1.9.2; IDT);  
 ДСТУ ETSI EN 301 489-17:2008 (ETSI EN 301 489-17:2008; IDT);  
 офіційне авторизоване розповсюдження продукції в Україні з технічного регламенту:  
 ДСТУ ETSI EN 300 328:2017 (ETSI EN 300 328:2016; IDT).  
(визначити рядок об'єкта, який має стосу до об'єкта вказаної в даній таблиці, зазначити відповідальність)

7. Призначений орган з оцінки відповідності **ООВ «Орган сертифікації Центр сертифікації матеріалів та виробів» (№ UA.TR.032)**  
(назва органу, сертифікаційний номер органу / реєстр органів призначеного органу)  
 Виконав роботи з оцінки відповідності за протоколом експертизи типу (Модуль В)  
(назва протоколу експертизи)  
 та видав сертифікат експертизи типу № UA.032.CT.0351-20 від 03 вересня 2020 р.  
(вказати номер протоколу експертизи / органу призначеного органу)

8. Додаткова інформація: програмна версія – V6.15.

Підписано від імені та за Дорученням № 6/н від 04.08.2020 р. «Continental Automotive GmbH» (Німеччина), уповноваженим представником в Україні - ТОВ «Нормакон-Україна» (Україна).

м. Мелітополь, Україна 03 вересня 2020 р.

Директор ТОВ «Нормакон-Україна» Шевчин Олександр Володимирович  
 М.П. ТОВ «ОС «ІСМВ»»  
 UA.032.D.00747-20  
 2020.09.03.16:40



Ukrainian models

Wireless Charger

справжнім Баш IBC Ко., Лтд.заявляє, що тип радіообладнання WC500HOC121 відповідає Технічному регламенту радіообладнання; повний текст декларації про відповідність доступний на веб-сайті за такою адресою: [http://bhevs.co.kr/bbs/board.php?tbl=e\\_bbs42\\_2](http://bhevs.co.kr/bbs/board.php?tbl=e_bbs42_2)

моделі; WC500HOC121

Manufacturer name: BH EVS Co.,Ltd.

Postal address:

Баш IBC Ко., Лтд.

25. Пхенчхон-ро 1996іон-джіл, Бапйонг-гу. Інчон. Республіка Корея

Operational frequency band: 111kHz

Maximum Output Power: 42dBuA/m @10m

Importer Name: Pride Motor LLC

Postal address: 73, Lesi Ukrainky Str., Vyshneve, Kyiv oblast, 08132, Ukraine

**ДЕКЛАРАЦІЯ ПРО ВІДПОВІДНІСТЬ**

- Бездротовий зарядний пристрій (Wireless Power Charger) т.л. HONDA моделі WC500HOC121 (індуктивне радіозв'язування)  
Радіообладнання (виріб, тип, номер партії чи серійний номер)
- Уповноважений представник виробника - ТОВ «ПрайдМоторс» (04070, Вул. Сагайдяного 12, М. Київ (Україна)) для зазначення:  
"BH EVS Co., Ltd", 25, Puchengchun-ro 1996ion-djil, Bapiong-gu, Incheon, Republic of Korea  
Найповніше та адресу виробника або його уповноваженого представника
- Ця декларація відповідності видана під особистою відповідальністю виробника.
- Об'єкт декларації (визначення радіообладнання, на яке дано зобов'язання щодо відповідності, згідно з вказаним номером)  
Об'єкт декларації (визначення радіообладнання, на яке дано зобов'язання щодо відповідності, згідно з вказаним номером)  
"Wireless Power Charger" (індуктивне радіозв'язування)



- Об'єкт декларації відповідає вимогам Технічного регламенту радіообладнання, затвердженого постановою НМ України від 24.05.2017 № 355.
- Об'єкт декларації відповідає вимогам наступних НД:  
ДСТУ EN 62368-1:2017 (EN 62368-1:2014, AC:2015-05, AC:2015-02, AC:2015-11, AC:2017, A11:2017, IOT1, IEC 62368-1:2014, MOC, Cor 1:2014, Cor 2:2015, IOT1), ДСТУ EN 62311:2014 (EN 62311:2008, IOT1), Draft ETSI EN 300-485-3 V2.2.1, ДСТУ EN 300-485-3:2009 (EN 300-485-3:2009, IOT1), ETSI EN 300-485-3 V1.1.3 (2017-09)  
Посилання на відповідні стандарти з повною назвою та номером, на будь-який з яких, або посилаючись на всі технічні стандарти, щодо яких декларована відповідність (за наявності цілого номера, версії та дати видання)
- Примовнений орган і місце відповідності:  
ООВ «Орган сертифікації» «Центр сертифікації матеріалів та виробів» (No. UA.18.032)  
(заявником, ідентифікаційний номер органу з реєстру промислових органів)  
вимогам добровільного відношення відповідності технічного проекту радіообладнання сформованого відповідно до Технічного регламенту радіообладнання, затвердженого постановою НМ України від 24.05.2017 № 355 за процедурою експертної типу (модель В) та видав сертифікат експертного типу № UA.032.СТ.0888-22 від 15 липня 2022 р.
- Додатковий інформації - місце зберігання технічного файлу поштою: jltm@parkbhevs.co.kr  
Підписано: BH EVS Co., Ltd. « 25, Puchengchun-ro 1996ion-djil, Bapiong-gu, Incheon, Republic of Korea)

**Jin Sup Park**  
BH EVS Vice President  
(Ім'я, прізвище та по батькові, посада)

18.07.2022р.  
(Дата)

Information





Moldova models

BCM  
Keyless Access System

Intended use:  
Short range device for remote control  
Postal address:  
Siemensstrasse 12  
D-93055 Regensburg  
Germany  
Manufacturer name:  
Continental Automotive GmbH  
Frequency band: 125KHz  
Maximum transmitted output: 10mW  
Importer Name:  
Honda Motor Europe Ltd - Aalst Office  
Postal address:  
Wijngaardveld 1 (Noord V) 9300 Aalst - Belgium



Information



Moldova models

Adaptive Cruise Control/ Collision Mitigation Braking System

<http://continental.automotive-approvals.com/>



Prin prezenta, ADC Automotive Distance Control Systems GmbH declară că tipul de echipamente radio ARS5-B este în conformitate cu Reglementarea tehnică „Punerea la dispoziție pe piață a echipamentelor radio” .

Textul integral al declarației de conformitate este disponibil la următoarea adresă de Internet:

<http://continental.automotive-approvals.com/>

Intended use:

SRD for RTTT and industrial use operating in the 76.0-77.0GHz range

Postal address:

Peter-Dornier-Strasse 10, 88131 Lindau, Germany

Operational frequency band:

76–77 GHz

Maximum Output Power:

2.0W (33dbm RMS EIRP)

Importer Name: Honda Motor Europe Ltd - Aalst Office

Postal address: Wijngaardveld 1 (Noord V) 9300 Aalst - Belgium

## Moldova models

## Hands-Free Telephone System

<http://www.ptc.panasonic.eu>



Prin prezenta, Panasonic Automotive Systems Co., Ltd. declară că echipamentul radio de tipul enumerat mai sus este în conformitate cu Directiva 2014/53/UE.

Accesați <http://www.ptc.panasonic.eu/>, faceți clic pe „Declaration of Conformity (Declarația de conformitate)”, introduceți cuvântul cheie de mai jos în caseta de căutare după cuvinte cheie și puteți să descărcați cea mai recentă „DECLARATION of CONFORMITY (DECLARAȚIE DE CONFORMITATE)” (DoC).

Prin prezenta, Panasonic Automotive Systems Co., Ltd. ție declară că tipul de echipamente radio [ \* ] este în conformitate cu Reglementarea tehnică „Punerea la dispoziție pe piață a echipamentelor radio”.

Textul integral al declarației de conformitate este disponibil la următoarea adresă de Internet:

<https://service.panasonic.ua>

Cuvânt cheie: [ \* ] Puteți vedea „Nr. ref” pe eticheta unității.

Keyword:

Model No. Keyword [ \* ]

CL-MH-----, CA-9H-----, CL-MH2CE6AD, CL-MH2CEAAD, CL-MH2CE7AD, CL-MH2CE8AD, CL-MH2DE3AD

You can see “Ref No” in unit label.

Intended use: Sistem audio auto (Bluetooth și WLAN)

Postal address:

Panasonic Automotive Systems Co., Ltd. 4261 Ikonobe-cho, Tsuzuki-ku, Yokohama-shi, Kanagawa-ken, 224-8520, Japan

Operational frequency band:

Specifications of Bluetooth Frequency band : 2402-2480MHz

Specifications of 2.4GHz WLAN Frequency band : 2412-2472MHz

Maximum transmitted output:

Specifications of Bluetooth Maximum output power: 0.1dBm

Specifications of 2.4GHz WLAN Maximum output power: 11.9dBm

Importer Name: Honda Motor Europe Ltd - Aalst Office

Postal address: Wijngaardveld 1 (Noord V) 9300 Aalst - Belgium

Moldova models

Blind Spot Information System/Cross Traffic Monitor

<http://continental.automotive-approvals.com/>



Prin prezenta, ADC Automotive Distance Control Systems GmbH declară că tipul de echipamente radio SRR5-B este în conformitate cu Reglementarea tehnică „Punerea la dispoziție pe piață a echipamentelor radio” . Textul integral al declarației de conformitate este disponibil la următoarea adresă de Internet: <http://continental.automotive-approvals.com/>

Intended use:

SRD for RTTT and industrial use operating in the 76.0-77.0GHz range

Postal address:

Peter-Dornier-Strasse 10, 88131 Lindau, Germany

Operational frequency band: 76-77 GHz

Maximum Output Power: 1.58 W (32dBm RMS EIRP)

Importer Name:

Honda Motor Europe Ltd - Aalst Office

Postal address:

Wijngaardveld 1 (Noord V) 9300 Aalst - Belgium

## Moldova models

## Telematics Control Unit

Prin prezenta, DENSO CORPORATION declară că tipul de echipamente radio este în conformitate cu Reglementarea tehnică „Punerea la dispoziție pe piață a echipamentelor radio”.

Textul integral al declarației de conformitate este disponibil la următoarea adresă de Internet:

<https://www.denso.com/global/en/contact-us/doc/>



Intended use: Telematics and Wi-Fi Hotspot device for Vehicle

Postal address: 1-1, Showa-cho, Kariya-shi, Aichi-ken, 448-8661, Japan

Operational frequency band: Model OGEY10

- 1) GSM900 (Tx: 880-915 MHz, Rx: 925-960 MHz)
- 2) GSM1800 (Tx: 1710-1785 MHz, Rx: 1805-1880 MHz)
- 3) WCDMA Band1 (Tx: 1920-1980MHz, Rx: 2110-2170 MHz)
- 4) WCDMA Band3 (Tx: 1710-1785 MHz, Rx: 1805-1880 MHz)
- 5) WCDMA Band8 (Tx: 880-915 MHz, Rx: 925-960 MHz)
- 6) LTE Band1 (Tx: 1920-1980MHz, Rx: 2110-2170 MHz)
- 7) LTE Band3 (Tx: 1710-1785 MHz, Rx: 1805-1880 MHz)
- 8) LTE Band7 (Tx: 2500-2570 MHz, Rx: 2620-2690 MHz)
- 9) LTE Band8 (Tx: 880-915 MHz, Rx: 925-960 MHz)
- 10) LTE Band20 (Tx: 832-862 MHz, Rx: 791-821 MHz)
- 11) WLAN IEEE802.11b (Tx/Rx: 2401-2473 MHz)
- 12) WLAN IEEE802.11g (Tx/Rx: 2402-2472 MHz)
- 13) WLAN IEEE802.11n (Tx/Rx: 2402-2472 MHz)
- 14) GPS (Rx: 1575.42 MHz)
- 15) GALILEO (Rx: 1575.42 MHz)
- 16) EGNOS (Rx: 1575.42 MHz)

Maximum Output Power:

- 1) 2 W 2) 1 W 3-5) 0.25 W 6)-10) 0.20 W 11) 0.032 W 12),13) 0.016 W

Importer Name: Honda Motor Europe Ltd - Aalst Office

Postal address: Wijngaardveld 1 (Noord V) 9300 Aalst - Belgium

Moldova models

Digital Key

<https://continental-homologation.com/honda>



Prin prezenta, Continental declară că tipul de echipamente radio A2C775684 este în conformitate cu Directiva 2014/53/UE. Textul integral al declarației UE de conformitate este disponibil la următoarea adresă internet

<https://continental-homologation.com/honda>

Intended use: Control Unit

Manufacturer name:

Continental Automotive Technologies GmbH

Postal address:

Siemensstraße 12, D-93055 Regensburg, Germany

Operational frequency band:

BLE frequency range: 2.402GHz to 2.48GHz

Maximum transmitted output:

BLE Maximum Output Power: +10dBm

Importer Name:

Honda Motor Europe Ltd - Aalst Office

Postal address:

Wijngaardveld 1 (Noord V) 9300 Aalst - Belgium

## Moldova models

## Wireless Charger

[http://bhevs.co.kr/bbs/board.php?tbl=e\\_bbs42\\_2](http://bhevs.co.kr/bbs/board.php?tbl=e_bbs42_2)

Prin prezenta, BH EVS Co.,Ltd. declară că tipul de echipamente radio WC500HOC121 este în conformitate cu Reglementarea tehnică „Punerea la dispoziție pe piață a echipamentelor radio” .

Textul integral al declarației de conformitate este disponibil la următoarea adresă de Internet:

[http://bhevs.co.kr/bbs/board.php?tbl=e\\_bbs42\\_2](http://bhevs.co.kr/bbs/board.php?tbl=e_bbs42_2)

Intended use: Wireless Power Charger for vehicle

Manufacturer name: BH EVS Co.,Ltd.

Postal address: Am Kronberger Hang 2 65824 Schwalbach am Taunus Germany

Operational frequency band: 111kHz

Maximum Output Power: 42dBuA/m @10m

Importer Name: Honda Motor Europe Ltd - Aalst Office

Postal address: Wijngaardveld 1 (Noord V) 9300 Aalst - Belgium

Moldova models

Remote Tuner

<https://service.panasonic.ua>



Prin prezenta, Panasonic Automotive Systems Co., Ltd. declară că tipul de echipamente radio [CQ-TH2BE0AD] este în conformitate cu Reglementarea tehnică „Punerea la dispoziție pe piață a echipamentelor radio”.

Textul integral al declarației de conformitate este disponibil la următoarea adresă de Internet:

<https://service.panasonic.ua>

Intended use: RADIO UNIT (Car radio tuner)

Postal address:

4261 Ikonobe-cho, Tsuzuki-ku, Yokohama-shi, Kanagawa-ken, 224-8520, Japan



Importer Name:

Honda Motor Europe Ltd - Aalst Office

Postal address:

Aalst Office Wijngaardveld 1 (Noord V) 9300 Aalst- Belgium

## EU Countries, Guadeloupe, North Macedonia, Martinique, Monaco, and Motenegro models

BCM Keyless Access System	FOB Keyless Remote
<a href="http://continental-homologation.com/honda">http://continental-homologation.com/honda</a>	<a href="http://continental-homologation.com/honda">http://continental-homologation.com/honda</a>
	
<p>Hereby, Continental Automotive GmbH declares that this model [41580430] is in compliance with the essential requirements and other relevant provisions of Directive 2014/53/EU.</p> <p>The full text of the EU declaration of conformity is available at the following internet address: <a href="https://continental-homologation.com/honda">https://continental-homologation.com/honda</a></p> <p>Intended use: Short range device for remote control</p> <p>Postal address: Siemensstrasse 12 D-93055 Regensburg Germany Manufacturer name: Continental Automotive GmbH Frequency band: 125KHz Maximum transmitted output: 10mW Importer Name: Honda Motor Europe Ltd - Aalst Office Postal address: Wijngaardveld 1 (Noord V) 9300 Aalst - Belgium</p>	<p>Hereby, Continental Automotive GmbH declares that this model [TP_4] is in compliance with the essential requirements and other relevant provisions of Directive 2014/53/EU.</p> <p>The full text of the EU declaration of conformity is available at the following internet address: <a href="https://continental-homologation.com/honda">https://continental-homologation.com/honda</a></p> <p>Intended use: Short range device for remote control</p> <p>Postal address: Siemensstrasse 12 D-93055 Regensburg Germany Manufacturer name: Continental Automotive GmbH Frequency band: 433.92MHz Maximum transmitted output: 1mW Importer Name: Honda Motor Europe Ltd - Aalst Office Postal address: Wijngaardveld 1 (Noord V) 9300 Aalst - Belgium</p>

EU Countries

Adaptive Cruise Control/ Collision Mitigation Braking System

<http://continental.automotive-approvals.com/>



Hereby, ADC Automotive Distance Control Systems GmbH declares that the radio equipment type ARS5-B is in compliance with Directive 2014/53/EU. The full text of the EU declaration of conformity is available at the following internet address: <http://continental.automotive-approvals.com/>

Intended use: Vehicle Distance Finding Radar

Postal address:

Peter-Dornier-Strasse 10, 88131 Lindau, Germany

Operational frequency band:

76–77 GHz



Maximum Output Power:

2.0W (33dbm RMS EIRP)

Importer Name: Honda Motor Europe Ltd - Aalst Office

Postal address: Wijngaardveld 1 (Noord V) 9300 Aalst - Belgium

## EU Countries

Hands-Free Telephone System	Blind spot information system/Cross Traffic Monitor
<a href="http://www.ptc.panasonic.eu/">http://www.ptc.panasonic.eu/</a>	<a href="http://continental.automotive-approvals.com/">http://continental.automotive-approvals.com/</a>
	
<p>Hereby, Panasonic Automotive Systems Co., Ltd. declares that the radio equipment type Listed above is in compliance with Directive 2014/53/EU. Access to <a href="http://www.ptc.panasonic.eu/">http://www.ptc.panasonic.eu/</a>, click "Declaration of Conformity", enter the below Keyword into the keyword search box, you can download the latest "DECLARATION of CONFORMITY" (DoC).</p> <p>Keyword: [CL-MH-----, CA-9H-----,CL-MH2CE9AD, CL-MH2DE2AD,CL-MH2CE2AD,CL-MH2CE3AD, CL-MH2CE6AD,CL-MH2CEAAD,CL-MH2CE7AD, CL-MH2DE0AD,CL-MH2CE8AD,CL-MH2DE3AD]</p> <p>You can see "Ref No" in unit label</p> <p>Intended use: Car Audio System (Bluetooth and WLAN)</p> <p>Postal address: Panasonic Automotive Systems Co., Ltd. 4261 Ikonobe-cho, Tsuzuki-ku, Yokohama-shi, Kanagawa-ken, 224-8520, Japan</p> <p>Operational frequency band: Specifications of Bluetooth Frequency band : 2402-2480MHz Specifications of 2.4GHz WLAN Frequency band : 2412-2472MHz Maximum Output Power: Specifications of Bluetooth Maximum output power : 0.1dBm Specifications of 2.4GHz WLAN Maximum output power : 11.9dBm Importer Name: Honda Motor Europe Ltd - Aalst Office Postal address: Wijngaardveld 1 (Noord V) 9300 Aalst - Belgium</p>	<p>Hereby, ADC Automotive Distance Control Systems GmbH declares that the radio equipment type SRR5-B is in compliance with Directive 2014/53/EU. The full text of the EU declaration of conformity is available at the following internet address: <a href="http://continental.automotive-approvals.com/">http://continental.automotive-approvals.com/</a></p> <p>Intended use: Automobile</p> <p>Postal address: Peter-Dornier-Strasse 10, 88131 Lindau, Germany</p> <p>Operational frequency band: 76–77 GHz</p> <p>Maximum Output Power: 1.58 W (32dBm RMS EIRP)</p> <p>Importer Name: Honda Motor Europe Ltd - Aalst Office</p> <p>Postal address: Wijngaardveld 1 (Noord V) 9300 Aalst - Belgium</p>

EU Countries

Telematics Control Unit

<https://www.denso.com/global/en/contact-us/doc/>



Hereby, DENSO CORPORATION declares that the radio equipment type is in compliance with Directive 2014/53/EU. The full text of the EU declaration of conformity is available at the following internet address:

<https://www.denso.com/global/en/contact-us/doc/>

Intended use: Telematics and Wi-Fi Hotspot device for Vehicle

Postal address:

1-1, Showa-cho, Kariya-shi, Aichi-ken, 448-8661, Japan

Operational frequency band: Model OGEY10

- 1) GSM900 (Tx: 880-915 MHz, Rx: 925-960 MHz)
- 2) GSM1800 (Tx: 1710-1785 MHz, Rx: 1805-1880 MHz)
- 3) WCDMA Band1 (Tx: 1920-1980 MHz, Rx: 2110-2170 MHz)
- 4) WCDMA Band3 (Tx: 1710-1785 MHz, Rx: 1805-1880 MHz)
- 5) WCDMA Band8 (Tx: 880-915 MHz, Rx: 925-960 MHz)
- 6) LTE Band1 (Tx: 1920-1980MHz, Rx: 2110-2170 MHz)
- 7) LTE Band3 (Tx: 1710-1785 MHz, Rx: 1805-1880 MHz)
- 8) LTE Band7 (Tx: 2500-2570 MHz, Rx: 2620-2690 MHz)
- 9) LTE Band8 (Tx: 880-915 MHz, Rx: 925-960 MHz)
- 10) LTE Band20 (Tx: 832-862 MHz, Rx: 791-821 MHz)
- 11) WLAN IEEE802.11b (Tx/Rx: 2401-2473 MHz)
- 12) WLAN IEEE802.11g (Tx/Rx: 2402-2472 MHz)
- 13) WLAN IEEE802.11n (Tx/Rx: 2402-2472 MHz)
- 14) GPS (Rx: 1575.42 MHz)
- 15) GALILEO (Rx: 1575.42 MHz)
- 16) EGNOS (Rx: 1575.42 MHz)

Maximum Output Power:

1) 2 W 2) 1 W 3-5) 0.25 W 6)-10) 0.20 W 11) 0.032 W 12),13) 0.016 W

Importer Name: Honda Motor Europe Ltd - Aalst Office

Postal address: Wijngaardveld 1 (Noord V) 9300 Aalst - Belgium

## EU Countries

## Digital Key

<https://continental-homologation.com/honda>



Hereby, Continental declares that the radio equipment type A2C775684 is in compliance with Directive 2014/53/EU. The full text of the EU declaration of conformity is available at the following internet address:

<https://continental-homologation.com/honda>

Intended use: Control Unit

Manufacturer name:

Continental Automotive Technologies GmbH

Postal address:

Siemensstraße 12, D-93055 Regensburg, Germany

Operational frequency band:

BLE frequency range: 2.402GHz to 2.48GHz

Maximum Output Power:

BLE Maximum Output Power: +10dBm

Importer Name:

Honda Motor Europe Ltd - Aalst Office

Postal address:

Wijngaardveld 1 (Noord V) 9300 Aalst - Belgium

EU Countries

Wireless Charger	Remote Tuner
<p><a href="http://bhevs.co.kr/bbs/board.php?tbl=e_bbs42_2">http://bhevs.co.kr/bbs/board.php?tbl=e_bbs42_2</a></p> <p>Hereby, BH EVS Co.,Ltd. declares that the radio equipment type WC500HOC121 is in compliance with Directive 2014/53/EU. The full text of the EU declaration of conformity is available at the following internet address: <a href="http://bhevs.co.kr/bbs/board.php?tbl=e_bbs42_2">http://bhevs.co.kr/bbs/board.php?tbl=e_bbs42_2</a></p> <p>Intended use: Wireless Power Charger for vehicle</p> <p>Manufacturer name: BH EVS Co.,Ltd. Postal address: Am Kronberger Hang 2 65824 Schwalbach am Taunus Germany</p> <p>Operational frequency band: 111kHz Maximum Output Power: 42dBuA/m @10m Importer Name: Honda Motor Europe Ltd - Aalst Office Postal address: Wijngaardveld 1 (Noord V) 9300 Aalst - Belgium</p>	<p><a href="http://www.ptc.panasonic.eu/">http://www.ptc.panasonic.eu/</a></p> <div data-bbox="1109 274 1197 341" style="text-align: center;">  </div> <p>Hereby, Panasonic Automotive Systems Co., Ltd. declares that the radio equipment type Listed above is in compliance with Directive 2014/53/EU. Access to <a href="http://www.ptc.panasonic.eu/">http://www.ptc.panasonic.eu/</a>, click "Declaration of Conformity", enter the below Keyword into the keyword search box, you can download the latest "DECLARATION of CONFORMITY" (DoC). Keyword: Model No. Keyword: [CQ-TH2BE0AD] You can see "Ref No" in unit label.</p> <p>Intended use: RADIO UNIT (Car radio tuner) Postal address: 4261 Ikonobe-cho, Tsuzuki-ku, Yokohama-shi, Kanagawa-ken, 224-8520, Japan Importer Name: Honda Motor Europe Ltd - Aalst Office Postal address: Wijngaardveld 1 (Noord V) 9300 Aalst - Belgium</p>

## British models

BCM Keyless Access System	FOB Keyless Remote
<a href="http://continental-homologation.com/honda">http://continental-homologation.com/honda</a>	<a href="http://continental-homologation.com/honda">http://continental-homologation.com/honda</a>
<b>UK CA</b>	<b>UK CA</b>
<p>Hereby, Continental Automotive GmbH declares that this model [41580430] is in compliance with the essential requirements and other relevant provisions of Radio Equipment Regulations 2017. The full text of the UK declaration of conformity is available at the following internet address: <a href="http://continental-homologation.com/honda">http://continental-homologation.com/honda</a></p> <p>Intended use: Short range device for remote control</p> <p>Postal address: Siemensstrasse 12 D-93055 Regensburg Germany Manufacturer name: Continental Automotive GmbH Frequency band: 125kHz +/- 3kHz Maximum transmitted output: 66dBuA/m at 10m</p> <p>Importer Name: Honda Motor Europe Ltd. Postal address: Cain Road, Bracknell, Berkshire, RG12 1HL, United Kingdom</p>	<p>Hereby, Continental Automotive GmbH declares that this model [TP_4] is in compliance with the essential requirements and other relevant provisions of Radio Equipment Regulations 2017. The full text of the UK declaration of conformity is available at the following internet address: <a href="http://continental-homologation.com/honda">http://continental-homologation.com/honda</a></p> <p>Intended use: Short range device for remote control</p> <p>Postal address: Siemensstrasse 12 D-93055 Regensburg Germany Manufacturer name: Continental Automotive GmbH Frequency band: 433.66MHz+/-16kHz 434.18MHz+/-16kHz Maximum transmitted output: 1mW</p> <p>Importer Name: Honda Motor Europe Ltd. Postal address: Cain Road, Bracknell, Berkshire, RG12 1HL, United Kingdom</p>

British models

**Adaptive Cruise Control/ Collision Mitigation Braking System**

<http://continental.automotive-approvals.com/>

Hereby, ADC Automotive Distance Control Systems GmbH declares that the radio equipment type ARS5-B is in compliance with Radio Equipment Regulations of the United Kingdom. The full text of the UK declaration of conformity is available at the following internet address: <http://continental.automotive-approvals.com/>

Intended use:SRD for RTTT and industrial use operating in the 76.0-77.0GHz range

Postal address:

Peter-Dornier-Strasse 10, 88131 Lindau, Germany

Operational frequency band:

76-77 GHz

Maximum Output Power:

2.0W (33dbm RMS EIRP)

Importer Name: Honda Motor Europe Ltd.

Postal address: Cain Road, Bracknell, Berkshire, RG12 1HL, United Kingdom

## British models

## Hands-Free Telephone System

<http://www.ptc.panasonic.eu/>



Hereby, Panasonic Automotive Systems Co., Ltd. declares that the radio equipment type [ \* ] is in compliance with The Radio Equipment Regulations 2017.

The full text of the UK declaration of conformity is available at the following internet address: <http://www.ptc.panasonic.eu/> enter the below Keyword into the keyword search box, you can download the latest "DECLARATION of CONFORMITY" (DoC).

Hereby, Panasonic Automotive Systems Co., Ltd. declares that the radio equipment type Listed above is in compliance with Directive 2014/53/EU. Access to <http://www.ptc.panasonic.eu/>, click "Declaration of Conformity", enter the below Keyword into the keyword search box, you can download the latest

"DECLARATION of CONFORMITY" (DoC).

Keyword: Model No. Keyword [\*] CL-MH-----, CA-9H-----,CL-MH2CE9AD,CL-MH2DE2AD,CL-MH2CE2AD,CL-MH2CE3AD

You can see "Ref No" in unit label.

Intended use: Car Audio System (Bluetooth and WLAN)

Postal address: Panasonic Automotive Systems Co., Ltd. 4261 Ikonobe-cho, Tsuzuki-ku, Yokohama-shi, Kanagawa-ken, 224-8520, Japan

Operational frequency band:

Specifications of Bluetooth

Frequency band : 2402-2480MHz

Specifications of 2.4GHz WLAN

Frequency band : 2412-2472MHz

Maximum Output Power:

Specifications of Bluetooth

Maximum output power : 0.1dBm

Specifications of 2.4GHz WLAN

Maximum output power : 11.9dBm

Importer Name: Honda Motor Europe Ltd.

Postal address: Cain Road, Bracknell, Berkshire, RG12 1HL, United Kingdom

British models

**Blind Spot Information System/Cross Traffic Monitor**

<http://continental.automotive-approvals.com/>

Hereby, ADC Automotive Distance Control Systems GmbH declares that the radio equipment type SRR5-B is in compliance with Radio Equipment Regulations of the United Kingdom. The full text of the UK declaration of conformity is available at the following internet address: <http://continental.automotive-approvals.com/>

Intended use:

SRD for RTTT and industrial use operating in the 76.0-77.0GHz range

Postal address:

Peter-Dornier-Strasse 10, 88131 Lindau, Germany

Operational frequency band: 76-77 GHz

Maximum Output Power: 1.58 W (32dBm RMS EIRP)

Importer Name:

Honda Motor Europe Ltd.

Postal address:

Cain Road, Bracknell, Berkshire, RG12 1HL, United Kingdom

## British models

## Telematics Control Unit

<https://www.denso.com/global/en/contact-us/doc/>



Hereby, DENSO CORPORATION declares that the radio equipment type is in compliance with the relevant statutory requirements. The full text of the UK declaration of conformity is available at the following internet address:

<https://www.denso.com/global/en/contact-us/doc/>

Intended use: Telematics and Wi-Fi Hotspot device for Vehicle

Postal address:

1-1, Showa-cho, Kariya-shi, Aichi-ken, 448-8661, Japan

Operational frequency band: Model OGEY10

- 1) GSM900 (Tx: 880-915 MHz, Rx: 925-960 MHz)
- 2) GSM1800 (Tx: 1710-1785 MHz, Rx: 1805-1880 MHz)
- 3) WCDMA Band1 (Tx: 1920-1980 MHz, Rx: 2110-2170 MHz)
- 4) WCDMA Band3 (Tx: 1710-1785 MHz, Rx: 1805-1880 MHz)
- 5) WCDMA Band8 (Tx: 880-915 MHz, Rx: 925-960 MHz)
- 6) LTE Band1 (Tx: 1920-1980MHz, Rx: 2110-2170 MHz)
- 7) LTE Band3 (Tx: 1710-1785 MHz, Rx: 1805-1880 MHz)
- 8) LTE Band7 (Tx: 2500-2570 MHz, Rx: 2620-2690 MHz)
- 9) LTE Band8 (Tx: 880-915 MHz, Rx: 925-960 MHz)
- 10) LTE Band20 (Tx: 832-862 MHz, Rx: 791-821 MHz)
- 11) WLAN IEEE802.11b (Tx/Rx: 2401-2473 MHz)
- 12) WLAN IEEE802.11g (Tx/Rx: 2402-2472 MHz)
- 13) WLAN IEEE802.11n (Tx/Rx: 2402-2472 MHz)
- 14) GPS (Rx: 1575.42 MHz)
- 15) GALILEO (Rx: 1575.42 MHz)
- 16) EGNOS (Rx: 1575.42 MHz)

Maximum Output Power:

1) 2 W 2) 1 W 3-5) 0.25 W 6)-10) 0.20 W 11) 0.032 W 12),13) 0.016 W

Importer Name: Honda Motor Europe Ltd.

Postal address: Cain Road, Bracknell, Berkshire, RG12 1HL, United Kingdom

British models

Digital Key

<https://continental-homologation.com/honda>



Hereby, Continental Automotive Technologies GmbH declares that this model [A2C775684] is in compliance with the essential requirements and other relevant provisions of Radio Equipment Regulations 2017.

The full text of the UK declaration of conformity is available at the following internet address:

<https://continental-homologation.com/honda>

Intended use: Control Unit

Manufacturer name:

Continental Automotive Technologies GmbH

Postal address:

Siemensstraße 12, D-93055 Regensburg, Germany

Operational frequency band:

BLE frequency range: 2.402GHz to 2.48GHz

Maximum Output Power:

BLE Maximum Output Power: +10dBm

Importer Name:

Honda Motor Europe Ltd.

Postal address:

Cain Road, Bracknell, Berkshire, RG12 1HL, United Kingdom

## British models

## Wireless Charger

[http://bhevs.co.kr/bbs/board.php?tbl=e\\_bbs42\\_2](http://bhevs.co.kr/bbs/board.php?tbl=e_bbs42_2)

Hereby, BH EVS Co.,Ltd. declares that the radio equipment type WC500HOC121 is in compliance with the Radio Equipment Regulations 2017. The full text of the declaration of conformity is available at the following internet address:

[http://bhevs.co.kr/bbs/board.php?tbl=e\\_bbs42\\_2](http://bhevs.co.kr/bbs/board.php?tbl=e_bbs42_2)

Intended use: Wireless Power Charger for vehicle

Manufacturer name: BH EVS Co.,Ltd.

Postal address: Am Kronberger Hang 2 65824 Schwalbach am Taunus Germany

Operational frequency band: 111kHz

Maximum Output Power: 42dBuA/m @10m

Importer Name: Honda Motor Europe Ltd.

Postal address: Cain Road, Bracknell, Berkshire, RG12 1HL, United Kingdom

British models

Remote Tuner

<http://www.ptc.panasonic.eu/>



Hereby, Panasonic Automotive Systems Co., Ltd. declares that the radio equipment type [ \* ] is in compliance with The Radio Equipment Regulations 2017.

The full text of the UK declaration of conformity is available at the following internet address:

<https://www.ptc.panasonic.eu/>

enter the below Keyword into the keyword search box, you can download the latest "DECLARATION of CONFORMITY" (DoC).

Keyword: Model No.

Keyword: [CQ-TH2BE0AD]

You can see "Ref No" in unit label.

Intended use:

RADIO UNIT (Car radio tuner)

Postal address:

4261 Ikonobe-cho, Tsuzuki-ku, Yokohama-shi, Kanagawa-ken, 224-8520, Japan

Importer Name:

Honda Motor Europe Ltd.

Postal address:

Cain Road, Bracknell, Berkshire, RG12 1HL, United Kingdom

## Compressor



**ContiMobilityKit**

563#####

EC Machinery Directive 2006/42/EC  
EMC Directive 2014/30/EU  
Noise Emission Direktive 2000/14/EC  
DIN EN ISO 12100:2011  
DIN EN 55025:2009 / EN 50498:2010  
ISO 7637-2:2011  
EN ISO 3744:2010

*Jürgen Busch* *Bala-Murali Krishna*  
Hannover, 06.03.2019 Hannover, 06.03.2019  
Jürgen Buschmann Bala-Murali Krishna  
Director BF Tire Systems Specialist Standards  
and Solutions & Regulations

**CE**

\* Continental Reifen Deutschland GmbH  
Vahrenwalder Straße 9  
30165 Hannover  
GERMANY

Continental ContiMobilityKit  
Compressor to pump  
sealant into tyres

563#####

**UK-DECLARATION OF CONFORMITY**  
in accordance with UK Government guidance

Manufacturer / Address: Continental Reifen Deutschland GmbH,  
Vahrenwalder Straße 9, 30165 Hannover, GERMANY

Continental Reifen Deutschland GmbH hereby confirms  
under its sole responsibility that the designated product,  
when used as intended, is in conformity with the essential  
requirements and other relevant requirements of following  
relevant regulations of the United Kingdom.

- Supply of Machinery (Safety) Regulations 2008
- Electromagnetic Compatibility Regulations 2016
- Noise Emission in the Environment by Equipment  
for Use Outdoors Regulations 2001

Applied designated standards in particular:  
DIN EN ISO 12100:2011 EN 50498:2010 EN ISO 3744:2010

Development, production, quality assurance and marketing  
are based on the standard IATF 16949.

**UK  
CA**

*Jürgen Busch* *A. Bahmann*  
Hannover, 13.07.2021 Hannover, 13.07.2021  
Jürgen Buschmann Adrian Bahmann  
Director BF ContiKit and Regulatory Compliance  
Accessories Specialist of Non-Tire Products

\* Not available on all models

## Compressor

<p><b>BG</b> ЕС декларация за съответствие Компресорна помпа с уплътнител за гуми Модел: Серийен номер:</p>	<p>Декларираме под собствена отговорност, че изброените продукти са в съответствие с всички приложими разпоредби на директивите и регламентите, изброени по-долу, както и със следните стандарти. Технически файл на: *</p>	<p><b>IT</b> Dichiarazione di conformità UE Compressore per l'iniezione di sigillante per pneumatici Modello: N. di serie:</p>	<p>Dichiariamo sotto la nostra sola responsabilità che i prodotti indicati sono conformi a tutte le disposizioni applicabili delle direttive e dei regolamenti sotto riportati, nonché agli standard seguenti. Scheda tecnica presso: *</p>
<p><b>CNR</b> EU-Deklaracija o usaglašenosti Компресор за помпанье зaptивача за гуми. Model: Serijski broj:</p>	<p>Izjavljujemo na našu isključivu odgovornost da su navedeni proizvodi u skladu sa svim relevantnim odredbama dole navedenih direktiva i propisa i u skladu sa sledećim standardima. Техничка документација: *</p>	<p><b>LT</b> ES atitikties deklaracija Padangoms skirtas kompresorius su sandariklio pompa Modelis: Serijos numeris:</p>	<p>Prisiimdami visą atsakomybę patvirtiname, kad nurodyti produktai atitinka visas galiojančias toliau pateiktų direktyvų ir reglamentų nuostatas bei nurodytų standartų reikalavimus. Techninis failas iš: *</p>
<p><b>CS</b> EU prohlášení o shodě Kompressor čerpadla těsniva pro pneumatiky Model: Výrobní číslo:</p>	<p>Na vlastní odpovědnost prohlašujeme, že uvedený výrobek vyhovuje všem platným ustanovením směrnic a nařízení, která jsou uvedena níže, a jsou v souladu s následujícími normami. Техничка документация в: *</p>	<p><b>LV</b> EK atbilstības deklarācija Riepu hermetizēšanas un piesūknēšanas ierīce Modelis: Sērijas numurs:</p>	<p>Mēs, uzņemoties pilnu atbildību, paziņojam, ka šie produkti atbilst visiem tālāk norādītajiem standartiem un direktīvu un noteikumu piemērojamajām prasībām. Техничка документација: *</p>
<p><b>DA</b> EU-erklæring om overensstemmelse Tætningspumpekompessor til dæk Model: Serienummer:</p>	<p>Vi erklærer under eget ansvar, at de angivne produkter overholder alle gældende bestemmelser i de nedenfor anførte direktiver og forskrifter og er i overensstemmelse med følgende standarder. Техничка фил пà: *</p>	<p><b>MT</b> Dikjarazzjoni tal-Konformità tal-UE Kompessor tal-pompa bis-sigilliant għat-tajers Mudell: Numru tas-serje:</p>	<p>Taht ir-responsabbiltà assoluta tagħna aħna niddikjaraw li l-prodotti msemmija huma konformi mad-dispożizzjonijiet kollha applikabbli tad-direttivi u r-regolamenti eleankati hawn isfel u huma konformi mal-istandards li ġejjin. File tekniku f': *</p>
<p><b>DE</b> EU-Konformitätserklärung Kompressor zum Pumpen von Dichtmittel für Reifen Modell: Seriennummer:</p>	<p>Wir erklären in alleiniger Verantwortung, dass die genannten Produkte allen einschlägigen Bestimmungen der nachfolgend aufgeführten Richtlinien und Verordnungen entsprechen und mit folgenden Normen übereinstimmen. Техниче Unterlagen bei: *</p>	<p><b>NL</b> EU-verklaring van overeenstemming Pompcompressor voor het sealen van banden Model: Serienummer:</p>	<p>Hiermee verklaren wij onder onze uitsluitende verantwoordelijkheid, dat de vermelde producten voldoen aan alle van toepassing zijnde bepalingen van de hieronder vermelde richtlijnen en verordeningen en in overeenstemming zijn met de volgende normen. Технич dossier bij: *</p>
<p><b>EL</b> Δήλωση συμμόρφωσης ΕΕ Κομπρεσέρ σφραγιστικού ελαστικών Μοντέλο: Σειριακός αριθμός:</p>	<p>Δηλώνουμε με αποκλειστική μας ευθύνη ότι τα αναφερόμενα προϊόντα συμμορφώνονται προς το σύνολο των εφαρμοστέων διατάξεων των οδηγιών και κανονισμών που παρατίθενται παρακάτω και πληρούν τα ακόλουθα πρότυπα. Τεχνικός φάκελος: *</p>	<p><b>NO</b> EU-samsvarserklæring Forsøglingspumpe-kompessor for dekk Modell: Serienummer:</p>	<p>Vi erklærer under eneansvar at de oppgitte produktene samsvarer med alle gjeldende bestemmelser i direktivene og forordningene oppført nedenfor, og er i samsvar med følgende standarder. Техничк фил пà: *</p>
<p><b>EN</b> EU Declaration of Conformity Compressor to pump sealant into tyres Model: Serial number:</p>	<p>We declare under our sole responsibility that the stated products comply with all applicable provisions of the directives and regulations listed below and are in conformity with the following standards. Техничка фил at: *</p>	<p><b>PL</b> Deklaracja zgodności UE Kompresor do pompowania uszczelnacza opon Model: Numer seryjny:</p>	<p>Deklarujemy z pełną odpowiedzialnością, że przedmiotowe produkty są zgodne z wszelkimi wymienionymi poniżej obowiązującymi przepisami dyrektyw i rozporządzeń oraz że spełniają poniższe normy. Dokumentacja techniczna: *</p>
<p><b>ES</b> Declaración UE de conformidad Compressor para bombeo de agente obturador para neumáticos Modelo: Número de serie:</p>	<p>Declaramos, bajo nuestra exclusiva responsabilidad, que los productos nombrados cumplen con todas las disposiciones correspondientes de las directivas y los reglamentos mencionados a continuación y están en conformidad con las siguientes normas. Documentación técnica en: *</p>	<p><b>PT</b> Declaração de conformidade UE Compressor da bomba de vedante para pneus Modelo: Número de série:</p>	<p>Declaramos sob a nossa exclusiva responsabilidade que os produtos mencionados respeitam todas as disposições aplicáveis das diretivas e regulamentos listados abaixo e que estão em conformidade com as seguintes normas. Ficha técnica em: *</p>

## Compressor

<b>ET</b> <b>ELI vastavusdeklaratsioon</b> Rehvikompressor hermeetiku pump Model: Seerianumber:	Kinnitame oma ainuvastutusel, et nimetatud tooted vastavad kõigi allpool nimetatud direktiivide ja määruste asjakohastele sätetele ning on kooskõlas alljärgnevatel sätetel: Tehnilise kausta leiate aadressilt: *	<b>RO</b> <b>Declarație de conformitate UE</b> Compresor cu pompă de material de etanșare pentru anvelope Model: Număr de serie:	Declarăm pe propria noastră răspundere că produsele menționate sunt în conformitate cu prevederile în vigoare ale directivelor și reglementărilor enumerate mai jos și sunt în conformitate cu următoarele standarde. Dosarul tehnic la: *
<b>FI</b> <b>EU-vaatimustenmukaisuusvakuutus</b> Kompressorit tiivisteaineen pumppaamiseksi renkaaseen Malli: Sarjanumero:	Vakuutamme yksinomaisella vastuullamme, että mainitut tuotteet noudattavat kaikkien alla lueteltujen direktiivien ja asetusten sovellettavia säännöksiä ja ovat seuraavien standardien mukaisia. Tekninen asiakirja: *	<b>SK</b> <b>Vyhľadanie o zhode EÚ</b> Kompresor čerpadla tesniaceho prostriedku pre pneumatiky Model: Sériové číslo:	Vyhlasujeme na našu vylučnú zodpovednosť, že uvedené produkty spĺňajú všetky príslušné ustanovenia nižšie uvedených smerníc a predpisov a že sú v súlade s nasledujúcimi normami. Technický súbor na: *
<b>FR</b> <b>Déclaration de conformité UE</b> Compresseur de gonflage avec injection de produit d'étanchéité pour pneus Modèle : Numéro de série :	Nous déclarons, sous notre entière responsabilité, que les produits indiqués sont conformes à toutes les dispositions applicables des directives et des règlements énumérés ci-dessous et qu'ils sont en conformité avec les normes suivantes. Fichier technique à: *	<b>SL</b> <b>Izjava EU o skladnosti</b> Kompresor črpalke za tesnilno sredstvo za pnevmatike Model: Serijska številka:	Z izključno odgovornostjo izjavljamo, da so navedeni izdelki skladni z vsemi veljavnimi določbami spodaj navedenih direktiv in predpisov ter so v skladu z naslednjimi standardi. Tehnična dokumentacija: *
<b>GA</b> <b>Dearbhú Comhréireachta AE</b> Comhbhrúiteoir teannaire séaltáin do bhoinn Múnla: Sraithuimhir:	Dearbhaimid faoinár bhfreagracht agus faoinár bhfreagracht féin amháin go gcomhlíonann na táirgí a leagtar síos gach foráil is infheidhme de na teoracha agus de na rialacháin a liostaítear thíos agus go bhfuil síd i gcomhréir leis na caighdeáin a leanas. Comhad teicniúil ag: *	<b>SR</b> <b>EU-Deklaracija o usaglašenosti</b> Kompresor za pumpanje zaptivača za gume. Model: Serijski broj:	Izjavljujemo na našu isključivu odgovornost da su navedeni proizvodi u skladu sa svim relevantnim odredbama dole navedenih direktiva i propisa i u skladu sa sledećim standardima. Tehnička dokumentacija: *
<b>HR</b> <b>EU izjava o usklađenosti</b> Kompresor brtvne pumpe za gume Model: Serijski broj:	Izjavljujemo pod isključivom odgovornošću da navedeni proizvodi udovoljavaju svim primjenjivim odredbama dole navedenih direktiva i propisa te su usklađeni sa sljedećim standardima. Tehnička datoteka: *	<b>SV</b> <b>EU-försäkran om överensstämmelse</b> Tättningsmedelpump för däck Modell: Serienummer:	Vi försäkras på eget ansvar att de angivna produkterna överensstämmer med alla gällande bestämmelser i de direktiv och föreskrifter som anges nedan och att de överensstämmer med följande standarder. Teknisk dokumentation finns på: *
<b>HU</b> <b>EU-megfelelősségi nyilatkozat</b> Tömítőanyag-kompresszor gumiabronsokhoz Modell: Sorozatszám:	Kizárólagos felelősségünk tudatában kijelentjük, hogy a megnevezett termékek megfelelnek az alább felsorolt irányelvek és szabályozások vonatkozó rendelkezéseinek, valamint megfelelnek a következő normáknak. Műszaki dokumentáció helye: *	<b>TR</b> <b>AB Uygunluk Beyanı</b> Lastikler için dolgu malzemesi pompa kompresörü Model: Seri numarası:	Tek sorumsuzu biz olarak, belirlenen ürünlerin aşağıdaki direktif ve yönetelerin uygulanabilir tüm hükümlerine uyumlu olduğunu ve aşağıdaki standartlara uygunluk taahhüdünü beyan ederiz. Teknik dosya konumu: *
<b>IS</b> <b>ESB Samræmisýfirlýsing</b> Innsiglisðæluþettir fyrir dækk Gerð: Raðnúmer:	Við lýsum því yfir á eigin ábyrgð að framangreindar yörur séu í samræmi við öll viðeigandi ákvæði tilskipana og reglugerða sem hér eru lýst og eru í samræmi við eftirfarandi staðla. Tækniskrá geymd hjá: *	<b>UK</b> <b>EU-Декларація відповідності</b> Компресор для накачування шинного герметика Модель: Серійний номер:	Ми заявляємо під нашу виключну відповідальність, що згадані продукти відповідають усім відповідним положенням інструкцій та правил, перелічених нижче, і відповідають наступним стандартам. Технічна документація: *

## ■ Meter open source licence

The software embedded in this product includes open source software. Refer to the following website for details regarding the open source software.

[https://www.nippon-seiki.co.jp/global/business\\_ic\\_meter/](https://www.nippon-seiki.co.jp/global/business_ic_meter/)

## ■ TCU open source licence

Free/Open Source Software Information

This product contains Free/Open Source Software(FOSS).

The licence information and/or the source code of such FOSS can be found at the following URL.

<https://www.denso.com/global/en/opensource/tcu/honda/>

## ■ Multi-View Camera open source licence

Free/Open Source Software Information

This product contains Free/Open Source Software(FOSS).

The licence information and/or the source code of such FOSS can be found at the following URL.

<http://car.panasonic.jp/oss/n03pkdl6>

## ■ Driver Monitoring Camera open source licence

Open Source Software Information

This product contains Open Source Software(OSS).

The licence information OSS can be found at the following URL.

[http://www.embedded-carmultimedia.jp/RTOS/License/oss/DMS\\_0301/](http://www.embedded-carmultimedia.jp/RTOS/License/oss/DMS_0301/)

## Numbers

<b>12-Volt Battery</b> .....	715
Charging System Indicator .....	121, 757
Maintenance	
(Checking the 12-Volt Battery) .....	715
Maintenance (Replacing) .....	718
<b>12-Volt Battery Charging System</b>	
Indicator .....	121, 757

## A

<b>ABS (Anti-lock Brake System)</b> .....	597
<b>Accessories and Modifications</b> .....	733
<b>Accessory Power Sockets</b> .....	276
<b>Acoustic Vehicle Alerting System</b> .....	444
<b>Active Lane Change Assist</b> .....	132, 570
<b>Adaptive Cruise Control (ACC) with Low Speed Follow</b> .....	526
Indicator (Amber) .....	130
Indicator (White/Green) .....	131
<b>Adaptive Damper System</b> .....	451
<b>Adaptive Driving Beam</b> .....	238
Indicator .....	126
<b>Adding</b>	
Coolant .....	696
Engine Oil .....	695
Washer .....	702
<b>Additives, Engine Oil</b> .....	692
<b>Adjustable Speed Limiter</b> .....	454
Indicator .....	131

<b>Adjusting</b>	
Armrest .....	262
Front Seats .....	252
Head Restraints .....	259
Headlights .....	237
Mirrors .....	248
Sound .....	312
Steering Wheel .....	247
<b>Adjusting Headlight Distribution</b> .....	478
<b>Agile Handling Assist</b> .....	468
<b>Air Conditioning System</b>	
<b>(Climate Control System)</b> .....	283
Changing the Mode .....	283
Defrosting the Windscreen and Windows .....	285
Dust and Pollen Filter .....	724
Recirculation/Fresh Air Mode .....	284
Sensors .....	288
Using Automatic Climate Control .....	283
<b>Air Pressure</b> .....	781
<b>Airbags</b> .....	62
After a Collision .....	64
Airbag Care .....	83
Centre Airbag .....	74
Event Data Recorder .....	1
Front Airbags (SRS) .....	64
Indicator .....	81, 123
Knee Airbags .....	70
Sensors .....	62
Side Airbags .....	76
Side Curtain Airbags .....	79

<b>AM/FM Radio</b> .....	320
<b>Ambient Meter</b> .....	159
<b>Android Auto</b> .....	348
<b>Anti-lock Brake System (ABS)</b> .....	597
Indicator .....	123
<b>Apple CarPlay</b> .....	343
<b>Armrest</b> .....	262
<b>Audio Remote Controls</b> .....	296
<b>Audio System</b> .....	290
Adjusting the Sound .....	312
AM/FM Radio .....	320
Android Auto .....	348
App Shortcut Function .....	303
Apple CarPlay .....	343
Audio Remote Controls .....	296
Audio System Function .....	293
Audio/Information Screen .....	302
Basic Operation .....	293
Bluetooth® Audio .....	334
Clock Setup .....	309
DAB .....	325
Display Setup .....	313
Error Messages .....	397
FLAC/PCM/WAVE/MP4/AVI/MKV/ASF/WMV .....	331
General Information .....	398
How to Update .....	314
How to Update Wirelessly .....	317
How to Update with a USB Device .....	318
iPod .....	328
MP3/WMA/AAC .....	331

- On-Board Owner's Manual ..... 298
  - PHEV Menu ..... 352
  - Power Flow..... 357
  - Radio Data System (RDS)..... 323
  - Reactivating..... 291
  - Security Code..... 291
  - Selecting an Audio Source ..... 308
  - Start Up..... 292
  - Status Area..... 308
  - System Updates ..... 314
  - System Updates Settings..... 315
  - Theft Protection..... 291
  - USB Flash Drives ..... 331, 398
  - USB Ports..... 295
  - Voice Control Operation..... 299
  - Wallpaper Setup..... 310
  - Wi-Fi Connection..... 341
  - Audio System Theft Protection** ..... 291
  - Audio/Information Screen**..... 302
  - Automatic Brake Hold**..... 594
    - Indicator..... 120, 594
  - Automatic Folding Door Mirror**
    - Function..... 250
  - Automatic Intermittent Wipers** ..... 242
  - Average Fuel Economy**..... 168
  - Average Speed**..... 171
- B**
- Battery**
    - 12-Volt Battery Charging System
      - Indicator..... 121, 757
    - Charging..... 654
    - High Voltage..... 667
    - If the 12-Volt Battery Is Dead..... 753
    - Safety Checklist..... 654
  - Belts (Seat)** ..... 49
  - Beverage Holders** ..... 268
  - Blind Spot Information System**..... 471
  - Bluetooth® Audio** ..... 334
  - Booster Seats (For Children)** ..... 111
  - Brake System** ..... 590
    - Anti-lock Brake System (ABS)..... 597
    - Automatic Brake Hold ..... 594
    - Brake Assist System ..... 598
    - Fluid..... 701
    - Foot Brake..... 593
    - Indicator..... 118, 119, 120, 759, 761
    - Parking Brake..... 590
  - Bulb Replacement**
    - Active Cornering Lights ..... 703
    - Brake Light, Taillight, Rear Side Marker Light, and Rear Turn Signal Lights ..... 703
    - Front Turn Signal, Position/Daytime Running Lights ..... 703
    - Headlights..... 703
    - High-Mount Brake Light ..... 704
    - Rear Licence Plate Light..... 704
    - Side Turn Signal/Emergency Indicator Lights..... 703
    - Taillight, Rear Fog Light, and Back-Up Lights..... 704
    - Vanity Mirror Lights ..... 705
  - Bulb Specifications**..... 780
- C**
- Carbon Monoxide Gas** ..... 113
  - Carrying Luggage** ..... 417, 419
  - Certification Label** ..... 783
  - Changing Bulbs**..... 703
  - Charge Timer Setting**..... 662
  - CHARGE/DECEL Gauge** ..... 158
  - Charging**..... 654
    - AC Charger ..... 656
    - Charge Indicator (Vehicle Side)..... 661
    - High Voltage Battery..... 667
    - Timer ..... 662
    - Unable to Disengage the Charging Connector..... 774
  - Child Restraint System** ..... 85
    - Booster Seats ..... 111
    - Child Restraint System for Infants..... 88
    - Child Restraint System for Small Children ..... 90
    - Installing a Child Restraint System with a Lap/Shoulder Seat Belt..... 106
    - Larger Children ..... 110
    - Rear-facing Child Restraint System ..... 88

Selecting a Child Restraint System.....	91	<b>Current Mode for ACC with Low Speed</b>	<b>Doors</b> .....	189
Using a Tether .....	108	<b>Follow, the LKAS, and Traffic Jam</b>	Keys .....	189
<b>Child Safety</b> .....	85	<b>Assist</b> .....	Locking/Unlocking the Doors	
<b>Childproof Door Locks</b> .....	201	Customize Display .....	from the Inside.....	199
<b>Cleaning the Exterior</b> .....	729	Customized Features .....	Locking/Unlocking the Doors	
<b>Cleaning the Interior</b> .....	726		from the Outside.....	192
<b>Climate Control System</b> .....	283		Lockout Prevention System.....	198
Changing the Mode.....	283	<b>D</b>	<b>Drive Mode Switch</b> .....	445
Defrosting the Windscreen and		<b>DAB</b> .....	<b>Driver Attention Monitor</b> .....	525
Windows .....	285	<b>Daytime Running Lights</b> .....	<b>Driver Information Interface</b> .....	161, 164
Dust and Pollen Filter .....	724	<b>Dead Battery</b> .....	Switching the Display .....	164
Recirculation/Fresh Air Mode.....	284	<b>Deceleration</b> .....	<b>Driver Monitoring Camera</b> .....	588
Sensors.....	288	<b>Deceleration Paddle Selector</b> .....	<b>Driver's Seat Lumbar Support</b> .....	253
Using Automatic Climate Control.....	283	<b>Declaration of conformity Content</b>	<b>Driving</b> .....	415
<b>Clock</b> .....	161, 188	<b>Outline</b> .....	Braking .....	590
<b>CMBS (Collision Mitigation Braking</b>		Defaulting All the Settings .....	Transmission .....	433
<b>System)</b> .....	484	<b>Deflation Warning System</b> .....	<b>Driving Guidelines for Your Utility</b>	
<b>Coat Hooks</b> .....	269	Calibration .....	<b>Vehicle</b> .....	431
<b>Collision Mitigation Braking System</b>		Indicator.....	<b>Driving Position Memory System</b> .....	245
<b>(CMBS)</b> .....	484	<b>Defrosting the Windscreen and</b>	<b>Dust and Pollen Filter</b> .....	724
<b>Console Compartment</b> .....	267	<b>Windows</b> .....		
<b>Controls</b> .....	187	Demister .....		
<b>Coolant (Engine)</b>		<b>Devices that Emit Radio Waves</b> .....		
Overheating.....	755	<b>Dimming</b>		
<b>Cooling System</b> .....	696	Headlights .....		
Adding to the Radiator .....	698	Rearview Mirror .....		
Adding to the Reserve Tank .....	696	<b>Dipstick (Engine Oil)</b> .....		
<b>Creeping</b> .....	433	<b>Display Audio</b> .....		
<b>Cross Traffic Monitor</b> .....	607	<b>Display Setup</b> .....		
		<b>Door Mirrors</b> .....		
			<b>E</b>	
			<b>eCall Indicator</b> .....	408
			<b>ECON Mode Indicator</b> .....	128
			<b>Elapsed Time</b> .....	171
			<b>Electric Power Steering (EPS) System</b>	
			Indicator.....	124, 760
			<b>Emergency Call (eCall)</b> .....	408
			Automatic Emergency Call .....	408
			Manual Emergency Call.....	410

Emergency Stop Signal.....	599
Emergency Towing.....	771
<b>Engine</b>	
If the 12-Volt Battery Is Dead.....	753
Number.....	783
Oil.....	692
Switch Buzzer.....	227, 228
<b>Engine Coolant</b>	
Overheating.....	755
<b>Engine Oil</b> .....	692
Adding.....	695
Checking.....	694
Engine Oil Pressure Low Warning.....	757
Recommended Engine Oil.....	692
<b>Engine Oil Pressure Low Warning</b> .....	757
<b>EPS (Electric Power Steering) System</b> .....	760
Indicator.....	124
<b>EV Indicator</b> .....	122
<b>Exhaust Gas Hazard</b>	
(Carbon Monoxide).....	113
<b>Exterior Care (Cleaning)</b> .....	729
<b>Exterior Mirrors</b> .....	249
<b>F</b>	
<b>Features</b> .....	289
<b>Filter</b>	
Dust and Pollen.....	724
<b>Flat Tyre</b> .....	736
<b>Floor Mats</b> .....	727

<b>Fluids</b>	
Brake.....	701
Cooling System.....	696
Windscreen Washer.....	702
<b>FM/AM Radio</b> .....	320
<b>Folding Down the Rear Seats</b> .....	256
<b>Foot Brake</b> .....	593
<b>Front Airbags (SRS)</b> .....	64
<b>Front Cross Traffic Warning</b> .....	504
<b>Front Seat Heaters</b> .....	281
<b>Front Seats</b> .....	251
Adjusting.....	252
<b>Front Sensor Camera</b> .....	585
<b>Fuel</b> .....	34, 651
Average Fuel Economy.....	168
Economy and CO <sub>2</sub> Emissions.....	669
Gauge.....	157
Instant Fuel Economy.....	168
Low Fuel Indicator.....	123
Range.....	168
Recommendation.....	651
Refueling.....	651
<b>Fuel Economy and CO<sub>2</sub> Emissions</b> .....	669
<b>Fuel Fill Cap</b> .....	34, 652
<b>Fuel Fill Door</b> .....	34, 652, 772
<b>Fuses</b> .....	764
Inspecting and Changing.....	768
Locations.....	764, 766

<b>G</b>	
<b>Gauges</b> .....	157
<b>Glass (care)</b> .....	726, 731
<b>Glove Box</b> .....	266

<b>H</b>	
<b>Hands-Free Telephone System</b> .....	379
Automatic Import of Mobile Phonebook and Recent calls.....	389
Automatic Transferring.....	390
Favourite Contacts.....	391
HFT Buttons.....	379
HFT Menus.....	383
HFT Status Display.....	381
Limitations for Manual Operation.....	382
Making a Call.....	393
Options During a Call.....	396
Phone Settings Screen.....	385
Phone Setup.....	386
Receiving a Call.....	395
Ringtone.....	390
<b>Hazard Warning Button</b> .....	6, 7
<b>Head Restraints</b> .....	259
<b>Headlights</b> .....	229
Adaptive Driving Beam.....	238
Adjuster.....	237
Aiming.....	703
Dimming.....	229
Operating.....	229
<b>Head-Up Display</b> .....	179

Heated Door Mirror Button .....	244	<b>Indicators</b> .....	116	Hill Descent Control System (White/Green).....	129
Heated Steering Wheel .....	280	12-Volt Battery Charging System .....	121, 757	Immobilizer System .....	127
Heaters (Front Seat).....	281	Active Lane Change Assist(Amber).....	132	Intelligent Speed Limiter (White/Green) ...	131
Heaters (Rear Seat) .....	282	Active Lane Change Assist (White/Green).....	132	Lane Keeping Assist System (LKAS) (Amber).....	132
HFT (Hands-Free Telephone).....	379	Adaptive Cruise Control (ACC) with Low Speed Follow (Amber) .....	130	Lane Keeping Assist System (LKAS) (White/Green).....	132
High Voltage Battery.....	667	Adaptive Cruise Control (ACC) with Low Speed Follow (White/Green).....	131	Lights On .....	126
Charging .....	654	Adaptive Cruise Control (ACC) with Low Speed Follow Interval .....	131, 545	Low Fuel .....	123
<b>High Voltage Battery Charge Level</b>		Adaptive Driving Beam .....	126	Low Tyre Pressure/Deflation Warning System .....	125, 762
Gauge .....	158	Adjustable Speed Limiter .....	131	Malfunction Indicator Lamp.....	121, 758
<b>Hill Descent Control System</b> .....	452	Anti-lock Brake System (ABS).....	123	NORMAL Mode.....	128
Indicator .....	129	AUTO Mode .....	129	Parking Brake and Brake System (Amber).....	120, 761
<b>Hill Start Assist System</b> .....	430	Automatic Brake Hold .....	120, 595	Parking Brake and Brake System (Red) .....	118, 119, 759, 761
<b>Honda Parking Pilot</b> .....	626	Automatic Brake Hold System.....	120, 594	Parking Sensor .....	130, 605
<b>Honda SENSING/</b>		CHARGE Mode.....	129	Passenger Front Airbag On/Off.....	82, 123
Honda SENSING 360.....	35, 479	Collision Mitigation Braking System (CMBS) (Amber) .....	133	Power System.....	122
<b>Hydrophilic Mirror</b> .....	732	Collision Mitigation Braking System (CMBS) (Grey) .....	133	Ready.....	122
		Deceleration Paddle Selector .....	122	Rear Fog Light .....	126
<b>I</b>		Driver Monitoring Camera (Amber).....	137	Road Departure Mitigation (Amber).....	133
<b>Identification Numbers</b> .....	783	Driver Monitoring Camera (Grey).....	137	Road Departure Mitigation (Grey).....	133
Engine, Motor and Transmission .....	783	ECON Mode .....	128	Road Departure Mitigation System Steering Assist Auto OFF .....	133
Vehicle Identification.....	783	Electric Power Steering (EPS) System.....	124, 760	Safety Support (Amber).....	134
<b>If the 12-Volt Battery Is Dead</b> .....	753	EV .....	122	Safety Support (Green/Grey).....	137
<b>If You Cannot Disengage the Charging</b>		EV Mode .....	129	SAVE Mode.....	129
Connector .....	774	High Beam .....	126	Seat Belt Reminder .....	51, 122
<b>If You Cannot Open the Charge Lid</b> .....	773				
<b>If You Cannot Open the Tailgate</b> .....	775				
<b>Immobilizer System</b> .....	213				
Indicator .....	127				

- Security System Alarm ..... 127
- Shift Position ..... 121
- SNOW Mode ..... 128
- SPORT Mode ..... 128
- Supplemental Restraint System ..... 81, 123
- System Message ..... 130
- TOW Mode..... 128
- Transmission System..... 121, 762
- Turn Signal and Hazard Warning ..... 126
- Vehicle Stability Assist (VSA) OFF..... 124, 467
- Vehicle Stability Assist (VSA) System..... 124
- Information**..... 779
- Instant Fuel Economy** ..... 168
- Instrument Panel** ..... 115
- Intelligent Speed Limiter**..... 460
  - Indicator ..... 131
- Interior Convenience Items** ..... 263
- Interior Lights** ..... 263
- Interior Rearview Mirror** ..... 248
- iPhone** ..... 398
- iPod**..... 328, 398
  
- J**
- Jacking Points** ..... 748
- Jump Starting**..... 753
  
- K**
- Key Number Tag**..... 190
- Keyless Lockout Prevention** ..... 198
- Keys**..... 189
  - Lockout Prevention..... 198
  - Number Tag ..... 190
  - Rear Door Won't Open..... 201
  - Remote Transmitter ..... 196
  - Types and Functions ..... 189
- Kickdown**..... 433
- Knee Airbags** ..... 70
  
- L**
- Lane Change Collision Mitigation**..... 518
- Lane Keeping Assist System (LKAS)**..... 550
  - Indicator (Amber) ..... 132
  - Indicator (White/Green) ..... 132
- LaneWatch**..... 475
- Legal Information on Apple CarPlay/Android Auto** ..... 406
- Lights**..... 229, 703
  - Active Cornering Lights ..... 235
  - Adaptive Driving Beam ..... 238
  - Bulb Replacement ..... 703
  - Daytime Running Lights..... 234
  - Fog Light..... 233
  - Front Fog Lights ..... 233
  - High Beam Indicator..... 126
  - Interior ..... 263
  - Light Switches ..... 229
  - Lights On Indicator..... 126
  - Luggage Area Lights ..... 265
- Load Limits** ..... 419
- Locking/Unlocking** ..... 189
  - Childproof Door Locks ..... 201
  - From Inside ..... 199
  - From Outside ..... 192
  - Keys..... 189
  - Using a Key..... 197
- Locking/Unlocking the Doors from the Outside** ..... 192
- Lockout Prevention System** ..... 198
- Low Battery Charge** ..... 757
- Low Fuel Indicator** ..... 123
- Low Keyless Remote Signal Strength** ..... 191
- Low Speed Braking Control** ..... 498
- Low Tyre Pressure/Deflation Warning System Indicator** ..... 125, 762
- Lower Anchorages**..... 101
- Lubricant Specifications Chart** ..... 781
- Luggage (Load Limit)**..... 419
- Luggage Hook**..... 270
- Lumbar Support**..... 253
  
- M**
- Maintenance** ..... 173, 671
  - 12-Volt Battery ..... 715
  - Brake Fluid..... 701
  - Cleaning ..... 726
  - Climate Control ..... 723

Cooling System.....	696
Oil .....	694
Precautions.....	672
Radiator.....	698
Remote Transmitter .....	721
Replacing Light Bulbs .....	703
Safety .....	673
Service Reminder System.....	676
Transmission Fluid.....	700
Tyres.....	710
Under the Bonnet .....	689
<b>Malfunction Indicator Lamp .....</b>	<b>121, 758</b>
<b>Map Light Switches.....</b>	<b>264</b>
<b>Maximum Charge Setting .....</b>	<b>664</b>
<b>Maximum Permissible Weight .....</b>	<b>419</b>
<b>Message.....</b>	<b>337</b>
<b>Mirrors .....</b>	<b>248</b>
Adjusting.....	248
Door.....	249
Interior Rearview.....	248
<b>Modifications (and Accessories).....</b>	<b>733</b>
<b>MP3/WMA/AAC.....</b>	<b>331</b>
<b>Multi-View Camera.....</b>	<b>612</b>

## N

Navigation.....	171
NORMAL Mode Indicator.....	128
Numbers (Identification).....	783

## O

<b>Odometer.....</b>	<b>159</b>
<b>Off-road Guidelines.....</b>	<b>426</b>
<b>Oil (Engine) .....</b>	<b>692</b>
Adding.....	695
Checking.....	694
Engine Oil Pressure Low Indicator .....	757
Recommended Engine Oil.....	692
Viscosity .....	692
<b>On-Board Owner's Manual .....</b>	<b>298</b>
Open the Owner's Manual .....	298
<b>Open Source Licences.....</b>	<b>401, 830</b>
<b>Opening/Closing .....</b>	<b>690</b>
Bonnet.....	690
Panoramic Roof.....	223
Power Windows .....	220
Tailgate .....	202
<b>Other Interior Convenience Items.....</b>	<b>276</b>
<b>Outside Temperature Display .....</b>	<b>159</b>
<b>Overheating.....</b>	<b>755</b>

## P

<b>Paddle Selector .....</b>	<b>122</b>
Indicator.....	122
<b>Panoramic Roof .....</b>	<b>223</b>
<b>Parking Brake .....</b>	<b>590</b>
Parking Brake and Brake System Indicator (Amber).....	120
Parking Brake and Brake System Indicator (Red).....	118, 119

<b>Parking Brake and Brake System Indicator.....</b>	<b>759</b>
<b>Parking Brake and Brake System Indicator (Amber).....</b>	<b>761</b>
<b>Parking Brake and Brake System Indicator (Red).....</b>	<b>761</b>
<b>Parking Sensor System .....</b>	<b>602</b>
<b>Passenger Front Airbag Off System .....</b>	<b>67</b>
<b>Passenger Front Airbag On/Off Indicator.....</b>	<b>82, 123</b>
<b>Passing Indicators.....</b>	<b>229</b>
<b>Petrol.....</b>	<b>34, 651</b>
Economy and CO <sub>2</sub> Emissions .....	669
Gauge.....	157
Information.....	651
Instant Fuel Economy .....	168
Low Fuel Indicator.....	123
Refueling.....	651
<b>PHEV Menu.....</b>	<b>352</b>
<b>Playing Bluetooth® Audio.....</b>	<b>334</b>
<b>POWER Button .....</b>	<b>227</b>
<b>Power Flow .....</b>	<b>357</b>
<b>Power Flow Monitor .....</b>	<b>166</b>
<b>POWER Gauge.....</b>	<b>158</b>
<b>Power System .....</b>	<b>749</b>
Won't Start.....	749
<b>Power System Indicator .....</b>	<b>122</b>
<b>Power Windows .....</b>	<b>220</b>
<b>Precautions While Driving .....</b>	<b>431</b>
Rain .....	432
<b>Pregnant Women.....</b>	<b>59</b>

Puncture (Tyre) ..... 736

## R

Radiator ..... 698

Radio (AM/FM) ..... 320

Radio Data System (RDS) ..... 323

Range ..... 168

RDS (Radio Data System) ..... 323

Ready Indicator ..... 122

Rear Demister ..... 244

Rear Fog Light Indicator ..... 126

Rear Seat Heaters ..... 282

Rear Seat Reminder ..... 257

Rear Seats ..... 255

Rearview Mirror ..... 248

Reduced Stopping Power Warning ..... 758

Refuel Recommend ..... 413

Refueling ..... 651

    Fuel Gauge ..... 157

    Low Fuel Indicator ..... 123

    Petrol ..... 651, 780

Regulations ..... 784

Remote Transmitter ..... 196

### Replacement

    12-Volt Battery ..... 718

    Bulbs ..... 703

    Fuses ..... 764, 766

    Rear Wiper Blade Rubber ..... 708

    Remote Battery ..... 721

    Wiper Blade Rubber ..... 706

Resetting a Trip Meter ..... 168

Reverse Tilt Door Mirror ..... 249

Road Departure Mitigation ..... 510

    Indicator ..... 133

    On and Off ..... 513

## S

Safe Driving ..... 43

Safety Labels ..... 114

Safety Message ..... 0

Safety Support ..... 173

    Indicator (Amber) ..... 134, 135

    Indicator (Green/Grey) ..... 137

Seat Belts ..... 49, 173

    Adjusting the Shoulder Anchorage ..... 56

    Checking ..... 60

    Fastening ..... 54

    Installing a Child Restraint System with a Lap/

        Shoulder Seat Belt ..... 106

    Pregnant Women ..... 59

    Reminder ..... 51

    Warning Indicator ..... 51, 52, 122

Seat Heaters ..... 281

Seat Ventilation ..... 281

Seats ..... 251

    Adjusting ..... 251

    Driver's Seat Lumbar Support ..... 253

    Front Seats ..... 251

    Rear Seats ..... 255

    Seat Belt Reminder Indicator ..... 122

    Seat Heaters ..... 281

    Seat Ventilation ..... 281

Security System ..... 213

    Immobilizer System Indicator ..... 127

    Security System Alarm Indicator ..... 127

    Super Locking ..... 218

    Tilt Sensor ..... 217

    Ultrasonic Sensors ..... 216

Selecting a Child Restraint System ..... 91

Service Reminder System ..... 676

Setting the Clock ..... 188

Shift Button ..... 434

    Operation ..... 436

Shift Position Indicator ..... 121

Shifting (Transmission) ..... 434

Shoulder Anchorage ..... 56

Side Airbags ..... 76

Side Curtain Airbags ..... 79

SNOW Mode Indicator ..... 128

SOS Button ..... 410

SOS Cancel Button ..... 410

Spark Plugs ..... 780

Specifications ..... 780

Specified Fuel ..... 651, 780

Speed Alarm ..... 172

Speed Limiter, Adjustable ..... 454

Speed Limiter, Intelligent ..... 460

Speed/Distance Units ..... 175

Speedometer ..... 157

SPORT Mode Indicator ..... 128

SRS Airbags (Airbags) ..... 64

Steering Wheel .....	247	Towing Your Vehicle		Tyres .....	710
Adjusting .....	247	Emergency .....	771	Air Pressure .....	781
Stopping .....	600	Traffic Jam Assist .....	561	Checking and Maintaining .....	710
Storage Items .....	266	Traffic Sign Recognition System .....	160, 576	Inspection .....	710
Sunglasses Holder .....	271	Transmission .....	433, 434	Rotation .....	713
Super Locking .....	218	Creeping .....	433	Tyre Chains .....	714
Supplemental Restraint System (SRS) .....	64	Fluid .....	700	Wear Indicators .....	711
Indicator .....	123	Indicator .....	121	Winter .....	714
Switches		Kickdown .....	433		
(Around the Steering Wheel) .....	6, 7, 8, 227	Number .....	783		
System Message Indicator .....	130	Operating the Shift Button .....	436		
System Updates .....	314	Shift Position Indicator .....	436		
		Trip Meter .....	168		
<b>T</b>		TRK (Temporary Repair Kit) .....	736	<b>U</b>	
Tailgate .....	202	Troubleshooting .....	735	Ultrasonic Sensors .....	216
TCU Open Source Licence .....	830	Blown Fuse .....	764, 766	Under-floor Storage Area .....	272
Temperature		Brake Pedal Vibrates .....	39	Unlocking the Doors .....	192
Outside Temperature Display .....	159	Buzzer Sounds When Opening Door .....	39	Unlocking the Front Doors	
Temperature Sensor .....	159, 288	Charge Lid Won't Open .....	773	from the Inside .....	25
Temporarily Repairing a Flat Tyre .....	736	Charging Connector Won't Disengage ....	774	USB Flash Drives .....	331, 398
Temporary Repair Kit (TRK) .....	736	Emergency Towing .....	771	USB Ports .....	295
Tie-down Anchorages .....	270	Noise When Braking .....	40, 41		
Tilt Sensor .....	217	Overheating .....	755	<b>V</b>	
Time (Setting) .....	188	Power System Won't Start .....	749	Vanity Mirrors .....	11
Timer .....	662	Rear Door Won't Open .....	39, 201	Vehicle Identification Numbers .....	783
TOW Mode Indicator .....	128	Warning Indicators .....	116	Vehicle Stability Assist (VSA) .....	466
Towing a Trailer .....	420	Turn signals		OFF Button .....	467
Equipment and Accessories .....	421	Indicators (Instrument Panel) .....	126	OFF Indicator .....	124
Load Limits .....	420	Turning on the Power .....	428	System Indicator .....	124
		Does Not Activate .....	749	Ventilation (Seat) .....	281
		If the 12-Volt Battery Is Dead .....	753	Viscosity (Oil) .....	692, 781

<b>Voice Control Operation</b> .....	299	<b>Winter Tyres</b> .....	714
Audio Commands.....	300	Tyre Chains .....	714
General Commands.....	300	<b>Wipers and Washers</b> .....	241
List Commands.....	301	Automatic Intermittent Wipers .....	242
Navigation Commands .....	301	Checking and Replacing Wiper Blades .....	706
Phone Commands .....	300	Front .....	241
Standard Commands.....	301	Rear .....	243
Voice Portal Screen.....	300	<b>Wireless Charger</b> .....	277
Voice Recognition.....	299	<b>WMA</b> .....	331
<b>VSA (Vehicle Stability Assist)</b> .....	466	<b>Worn Tyres</b> .....	710

## W

<b>Wallpaper</b> .....	310
<b>Warning and Information Message</b> .....	138
<b>Warning Indicator On/Blinking</b> .....	757
<b>Warning Labels</b> .....	114
<b>Warnings</b> .....	178
<b>Watts</b> .....	780
<b>Wear Indicators (Tyre)</b> .....	711
<b>Wi-Fi Connection</b> .....	341
<b>Window Washers</b> .....	241
Adding/Refilling Fluid.....	702
Switch .....	241
<b>Windows (Opening and Closing)</b> .....	220
<b>Windscreen</b> .....	241
Cleaning.....	726, 731
Defrosting/Defogging .....	244, 285
Washer Fluid.....	702
Wiper Blades .....	706
Wipers and Washers .....	241