

**HONDA**

# Lawn & Garden









When we designed our range of gardening products we looked at your life from every angle.

Everything we learn, from everything we do, goes into the development of our lawn and garden products, allowing us to create new technologies and new ways of solving problems. Not only making them the very best they can be, but making them a joy to use and own. So it's not just clever engineering, it's **ENGINEERING FOR** *Life*



## CONTENTS

03 Product key features

### ROBOTIC MOWERS

05 Honda robotic mower benefits

07 Miimo HRM 310/520

09 Miimo HRM 3000

11 Robotic mower specification

### LAWNMOWERS

13 Honda lawnmower benefits

15 HRE lawnmowers

17 HRG lawnmowers

19 HRX lawnmowers

21 Professional lawnmowers

23 Lawnmower specification

### RIDE-ON MOWERS & LAWN TRACTORS

27 Honda ride-on mower & lawn tractor benefits

29 HF ride-on mowers & lawn tractors

31 HF premium lawn tractors

33 Ride-on mower & lawn tractor specification

### HANDHELD RANGE

35 Honda cordless range benefits

37 Cordless range

39 Honda handheld benefits

41 Handheld brushcutters

43 Handheld Versatool™

45 Handheld hedgetrimmer & leaf blower

47 Handheld specification

### TILLER RANGE

49 Honda tiller benefits

51 Micro & mini tillers

53 Compact & versatile tillers

55 Counter-rotating tillers

57 Tiller specification

59 Power you rely on

61 World of Honda Power Equipment



# Product key features

All our latest technology explained in simple terms. At Honda we believe in constantly striving to improve. It's this spirit of self-challenge and passion for overcoming problems that allows us to create even more innovative ideas. So, whether it's making our products safer, more environmentally friendly, easier to use or simply helping your lawn to grow and flourish, you can rely on us to keep thinking of new ways to help you achieve your perfect lawn.



## MIIMO



### Rapid Reaction Bump and Lift Sensors

Miimo can sense contact, stopping the moment it touches an object or pet, turning and continuing in a different direction. It can also detect lifting or tilting, stopping the blades for absolute safety.



### Automatic Charging System

Miimo works for as long as you want. When needed, it heads off to recharge itself then gets straight back to work.



### Micro Mulching

Miimo cuts grass clippings into minute particles so they drop down through the grass and act as fertiliser. No more walking grass through the house.



### Zone Management

Zone management allows you to control when and where Miimo mows, to ensure complete coverage of your lawn, even in hard to reach areas.

AVAILABLE ON HRM 3000 ONLY



### Flexible Docking

Flexible docking allows you to position the docking station in a variety of positions in your garden, including corners, narrow passages or on your patio.



### Advanced Waterproofing

Not only is Miimo safe to use in the rain (all models are weatherproof), the HRM 3000 can even be washed with a hose pipe.



### Smartphone App

A simple and intuitive interface that allows you to change Miimo's set-up via Bluetooth™ with your smartphone.



### Electric Cutting Height Adjuster

The cutting height can be adjusted electronically, directly from the smartphone app.

## LAWNMOWER, RIDE-ON AND LAWN TRACTOR



### Auto-Choke

The intelligent auto-choke system automatically sets the choke to give optimum starting and running in all conditions.



### Electric Start

The electric key start ignition makes starting your lawnmower even easier and is fitted in addition to the standard recoil pull-start.



### Roto-Stop® Blade Brake Clutch

Stops the blades but leaves the engine running while you empty the grassbag or move across driveways with self-propelled models.



### Rear Roller

Models with a rear roller give your lawn that classic striped effect. A rear roller offers greater machine balance and control when cutting around the edge of your lawn.



### SMART Drive®

SMART Drive® is designed to give you fingertip control allowing you to adjust the speed control for greater accuracy.



### Select Drive

The all-new Select Drive additionally allows you to set a constant speed for relaxed mowing with increased comfort.



### Hydrostatic Drive

Hydrostatic Drive gives you greatest accuracy and a smooth, stepless speed control.



### Versamow™ Selective Mulching System

With a single lever, Honda's Versamow™ system will either collect the grass cuttings into the bag or finely shred and blow them down into the lawn to create a natural fertiliser.



### Versamow™ Variable Mulching System

With a single lever, Honda's Versamow™ system will either collect the grass cuttings into the bag or finely shred and blow them down into the lawn to create a natural fertiliser or the perfect mix of both.



### Pro Engine Pro Spec

Designed using steel and cast iron, these engines are built for more robust work.

AVAILABLE ON LAWN TRACTOR ONLY



### Optiflow\*

A fan improves air flow between the cutter deck and the high air flow grass bag. It significantly improves collecting performance of the lawnmower.



### Electric Grass Dump

The grass bag is opened with an electric motor at the touch of a switch.



### Synchronous Blade Cut

Both blades have an overlapping cutting area to create accurate mowing and avoid any uncut areas when turning.



## TILLER



### Side Clutch

The user-friendly side clutch stops the drive to either the right or the left tine, making changing direction easy.



### Side Discs

Side discs protect growing plants from flying debris or impact from slasher tines by keeping the tiller perfectly aligned when furrowing.



### Transport Wheel

For extra manoeuvrability, the transport wheel helps you move the tiller seamlessly between storage and work areas, even over kerbs and up hills.



### Power Take Off (PTO)

PTO draws power from the engine and makes it easy to connect and disconnect powered attachments to your tiller to make heavy jobs like hulling, spraying and mowing quicker.



### Gear Box

More gears means greater flexibility and power. The gearbox transfers the ideal power and torque to work the machine, letting you pick the perfect speed to match your pace.



### Counter-Rotating Tines

By rotating the tines in the opposite direction to each other the tiller becomes very balanced and easy to control, effortlessly breaking up the hardest soil quicker and more efficiently.



### Foldable Handle

Designed with convenient inward-facing knobs, this neat handle folds away for simple storage and transport.



### Swing Handle

With a reassuring safety release feature, the swing handle can be adjusted to swing left or right which allows you to work without leaving footprints behind you, and avoids compressing already cultivated soil and plants.





# Honda robotic mower benefits

**Miimo cuts your lawn so you don't have to.**

**Miimo is our range of clever robotic mowers that are completely autonomous and can look after your lawn without any assistance.**

Miimo is so clever, in fact, it can even recharge itself when it detects the batteries are low. It's thoughtful too, only working when it suits you, and because it is so quiet and efficient, Miimo can be set to work at night without disturbing you or your neighbours.

Miimo can be left to work safely and securely, automatically stopping its blades when it detects it's being picked up and automatically turning away from garden obstacles or pets.



## **Safety, our priority**

Miimo is equipped with sensors which stop the blades instantly when they detect any lifting or tilting. The 360° bump sensors modify its direction if an obstacle is detected, so it is safe to use around children or pets.

## **Long lasting lithium-ion batteries**

Lithium-ion batteries not only offer a quiet, reliable and long lasting power source, but they are also very cost efficient to run.





### Flexible Docking System\*

Miimo's unique docking station can be installed in any location on your lawn, whether this is under a bush, down a narrow strip of grass or in a tight corner - allowing you to position it discreetly in your garden.

\*Only available for HRM 3000.

### Bluetooth™ smartphone app\*

An intuitive and easy to use interface which allows you to modify your Miimo's set-up via Bluetooth™ on your smartphone.

\*Only available for HRM 3000.

### Waterproof

Miimo HRM 3000 is fully waterproof and can tackle any weather, automatically mowing more often when grass is growing rapidly. The HRM 3000 can even be washed with a hose pipe.

### Slope capacity and uneven ground

Miimo is capable of cutting slopes of up to 25° with its high level of traction and grip. Thanks to its rapid reaction lift sensors it will never get stuck in a hole or uneven ground.

### Anti theft

Every Miimo can be protected with the use of a unique security code, which ensures it cannot be used by anyone else but you. It stops and sounds an alarm as soon as it is lifted and only restarts once your pin number has been accepted.

### Adjustable cutting height

You can easily adjust the cutting height to suit your lawn, from 20 mm to 60 mm. It can be adjusted electronically through the smartphone app with the HRM 3000 or manually with the HRM 310/520.





# Miimo HRM 310/520

Trust Miimo to take care of your lawn



**SPECIFICATION**

HRM 310	HRM 520
<b>MOWING AREA</b> Up to <b>1,500 m<sup>2</sup></b>	<b>MOWING AREA</b> Up to <b>3,000 m<sup>2</sup></b>
<b>SLOPE CAPACITY</b> Up to <b>24°</b>	<b>SLOPE CAPACITY</b> Up to <b>24°</b>
<b>USER INTERFACE</b> Control Panel	<b>USER INTERFACE</b> Control Panel



HRM 520



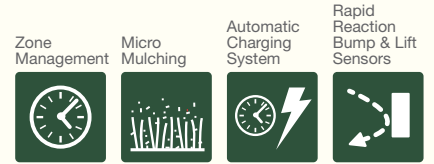

The Miimo HRM 310 and 520 robotic mower range is designed to cut your grass so you don't have to, making it the innovative and easy way for you to keep your lawn in perfect condition all-year round, with minimal effort.



*Recharging docking station*

**Autonomous and efficient**

Our intelligent robotic mower follows the layout of your garden, navigating between obstacles and mulching as it works to create a healthy, perfectly manicured lawn. Engineered for efficient performance and robust all-weather use, Miimo even knows when to recharge itself via its docking station.

**Quiet and reliable**

Because Miimo is powered by lithium-ion batteries, which are quiet and reliable, Miimo can be set to cut your lawn at night without disturbing you or your neighbours. It's also highly energy efficient, due to its low running costs and low environmental impact, with zero emissions.



*A clear and easy to use control panel which allows you to change Miimo's functions and set a security code*

**Safety first**

Miimo has been designed to be safe to use in any garden. It is equipped with sensors which detect any lifting or tilting motion and stop the blades instantly. Miimo uses a unique digital signal to guide itself round your garden, avoiding any possible interference from electronic devices nearby.



## Miimo HRM 3000

The high tech solution for a beautiful lawn



HRM 3000

### SPECIFICATION

#### HRM 3000

##### MOWING AREA

Up to  
**4,000 m<sup>2</sup>**

##### SLOPE CAPACITY

Up to  
**25°**

##### USER INTERFACE

Control Panel  
+  
smartphone app





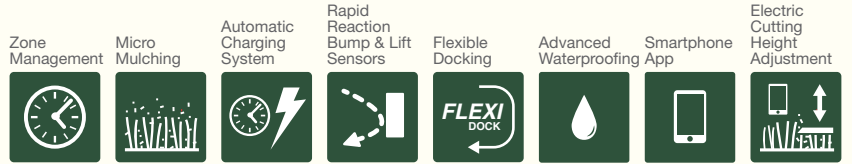

The Honda HRM 3000 is our very latest robotic lawnmower. It brings a whole world of new innovation to your garden and takes away a lot of the effort of keeping your lawn in perfect condition, giving you more time to do the things you love to do.



*Smooth-turn feature*



*Waterproof*

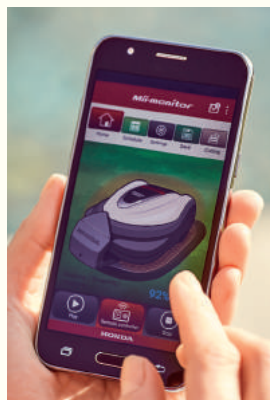

*Smartphone app allows you to control your Miimo remotely*

#### **Flexibility**

Miimo's docking station can be positioned in a variety of locations around your garden, giving you the flexibility to position it out of the way, in a quiet corner, in a narrow passage or behind the shed.

#### **Control**

Bluetooth™ connectivity comes as standard, with no additional components to be installed. The app has been designed to allow you to change settings, cutting height, start / stop or even drive Miimo by remote control. You can also access its monthly timer which allows you to stop Miimo cutting on a specific date.

#### **User friendly**



Miimo does all it can to make your life easier. It is waterproof, so it can cut your grass in any weather and you can clean it with a hose pipe. It can even look after itself if it encounters a problem, by sending a report via the app to a cloud support system which allows your dealer to check it remotely or update any software.

Miimo is quiet, giving it the flexibility to cut during the night without disturbing you or your neighbours. It is also highly efficient, featuring a smooth-turn facility, that enables it to turn away from the lawn edge without stopping.



# Robotic mower specification

Use our handy table to compare our robotic mowers and choose the right model for you.

ROBOTIC MOWER SPECIFICATION			
	HRM 310	HRM 520	HRM 3000
			
Area capacity	up to 1,500 m <sup>2</sup>	up to 3,000 m <sup>2</sup>	up to 4,000 m <sup>2</sup>
Working capacity	83 m <sup>2</sup> /h	125 m <sup>2</sup> /h	170 m <sup>2</sup> /h
Maximum incline mowing area	24° / 45%	24° / 45%	25° / 47%
Maximum incline wire on slope	10° / 17%	10° / 17%	15° / 27%
Noise level guaranteed*	62 dB(A)	62 dB(A)	59 dB(A)
Blade type	3 (Swing back type)	3 (Swing back type)	3 (Swing back type)
Cutting width	220 mm	220 mm	250 mm
Cutting height adjustment	Manual from 20 to 60 mm	Manual from 20 to 60 mm	Electric from 20 to 60 mm
Battery type	Li-ion 22.2V / 1.80Ah	Li-ion 22.2V / 3.6Ah	Li-ion 22.2V / 5.4Ah
Mowing time per charge	40 min	70 min	90 min
Charging time	30 min	60 min	45 min
Waterproofing	IPX4	IPX4	IPX5
Smartphone application**	-	-	Android and iOS
Docking station position	Parallel to boundary wire	Parallel to boundary wire	Flexible
Boundary wire and pegs supplied	200 m / 200 pegs	300 m / 300 pegs	-
Length x width x height	635 x 550 x 287 mm	635 x 550 x 287 mm	710 x 550 x 301 mm
Weight	11.6 kg	11.9 kg	13.8 kg

\*Quiet mode also available for even lower sound level.  
\*\*Smartphone must comply with minimal technical requirement to run the application.  
For further information, ask your Honda dealer.

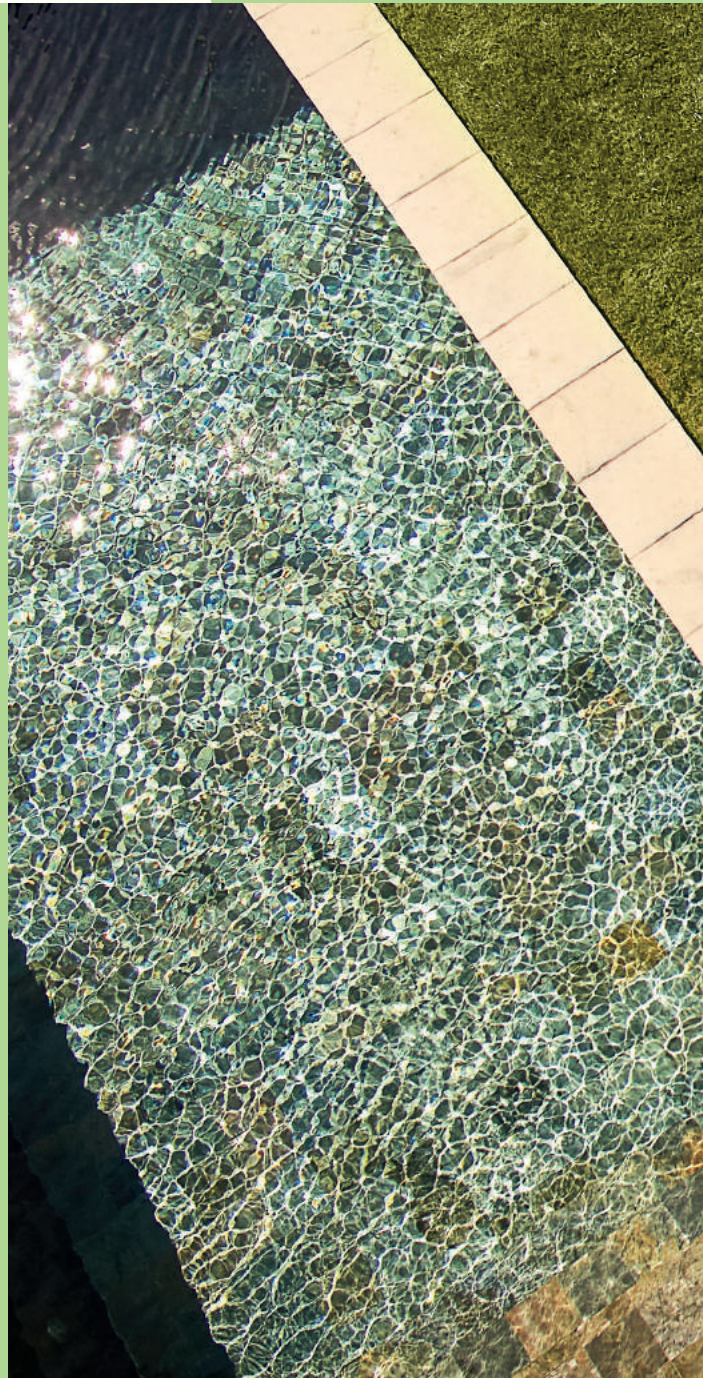

## Simulate Miimo cutting your lawn

Set Miimo to work in your garden with our clever Miimo lawn planner, which simulates Miimo navigating your own unique lawn.

It allows you to select the area you want Miimo to cut, customise its set-up and even suggest the model that is best suited to your garden.

Go to [honda http://www.honda.co.uk/lawn-and-garden/products/miimo/lawn-planner.html](http://www.honda.co.uk/lawn-and-garden/products/miimo/lawn-planner.html) click on Lawn planner and follow the easy steps.

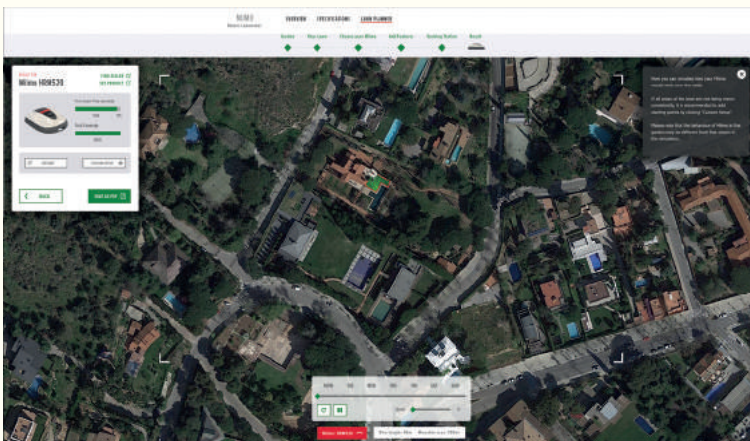





### **Your Honda dealer can help you**

A Honda authorised dealer can help you decide which Miimo suits your garden, and upon purchase can install the docking station and boundary wire. Our dealers are highly skilled and have followed specific training to ensure trouble free operation and installation, whatever the profile of your garden.



A wide range of accessories are available to enhance your experience. Find out more by visiting your local dealer, or heading to [www.honda.co.uk](http://www.honda.co.uk)



## Deck Materials

With three deck materials to choose from there is sure to be one to suit your needs.

**Cast aluminium decks** feature on the HRH and HRD series, these offer exceptionally high strength to weight ratio and resistance to corrosion.



**Polystyrene & Xenoy decks** as featured on the HRX series, are both very strong, durable polymer materials which are highly resistant to UV, corrosion and dents.



**Pressed steel, powder coated decks** as featured on the HRG series are built for durability and performance. They are lightweight for easy manoeuvrability whilst still being hard-wearing and resistant to deterioration from corrosion and UV rays.



## Safety systems

### Roto-stop® blade brake clutch

This feature enables you to release the blade engagement control which stops the blades, without turning off the engine. It allows you to move obstacles such as debris or toys from your mowing path, empty the grass bag or even cross over paths or driveways safely without the need to restart the engine.



**40th ANNIVERSARY**  
 Honda Lawnmowers  
 1978-2018

The HR21, Honda's first walk-behind lawn mower, was launched in August 1978. More than 300,000 units were sold across the world and the machine received rave reviews for its outstanding performance and ease of use.



# Honda lawnmower benefits

## Transmission Technology

Self-propelled lawnmowers make mowing the lawn easier, and Honda has three variable speed technologies: SMART Drive®, Select Drive and Hydrostatic Drive.

### SMART Drive®

Variable SMART Drive® is the latest self-propelled technology that provides subtle finger tip control, for accuracy around flowerbeds and borders.

### Select Drive

Variable Select Drive is a clever feature that enables you to set a constant speed whilst mowing, giving you a more relaxed and comfortable experience.

### Hydrostatic Drive

Honda's innovative Hydrostatic Drive gives you greater accuracy by providing smooth, stepless speed control.



## Honda Mulching

### Micro cut twin blade system

These are two stacked, offset blades, which allow grass to be cut into smaller pieces, producing a superior cut and finish to the lawn. The first blade makes the initial larger cut, the second blade a smaller cut. The clippings are then re-circulated around the deck with the blades continuing to cut them into finer and finer pieces. These fine pieces decompose quicker, giving a better result when mulching. They also take up less room when collecting, meaning less frequent emptying of the grass bag.

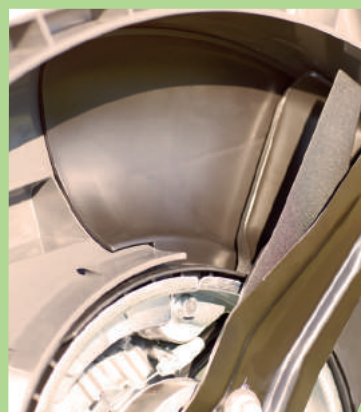

### Versamow™ selective

Switching between mulching, collecting or discharging is simply achieved by adjusting a lever. There is no need to insert a separate mulching plug when you wish to mulch, this capability is integrated and can be activated or deactivated quickly, easily and safely.

### Versamow™ variable

This system allows you to switch between mulching, collecting or discharging modes, via the easy to adjust lever. You can also control how much grass is collected or mulched. There are seven positions ranging from full collection to full mulching with five variable positions in-between, giving you any combination of the two. As the system is fully integrated, no additional tools or attachments are required.



Optiflow\*



\*Available on HRE 370 and HRE 410 only.



### SPECIFICATION

HRE 330 PLE	HRE 370 PLE	HRE 410 PE
<b>CUTTER DECK</b>	<b>CUTTER DECK</b>	<b>CUTTER DECK</b>
<b>33 cm</b>	<b>37 cm</b>	<b>41 cm</b>
<b>MOWING AREA</b>	<b>MOWING AREA</b>	<b>MOWING AREA</b>
Up to <b>200 m<sup>2</sup></b>	Up to <b>300 m<sup>2</sup></b>	Up to <b>500 m<sup>2</sup></b>
<b>ELECTRIC ENGINE</b>	<b>ELECTRIC ENGINE</b>	<b>ELECTRIC ENGINE</b>
<b>1,100 W</b>	<b>1,300 W</b>	<b>1,600 W</b>
<b>BAG CAPACITY</b>	<b>BAG CAPACITY</b>	<b>BAG CAPACITY</b>
<b>27 ltr</b>	<b>35 ltr</b>	<b>65 ltr</b>

Model availability is dependant on country, do not hesitate to ask your local Honda dealer.



A convenient carrying handle makes the HRE very easy to move whilst the main handle can be folded to make the most of storage space



Cutter deck height adjustment lever



## HRE lawnmowers

Electric, light and  
easy to handle



**Perfect for smaller gardens, our HRE range is powerful enough to cut your lawn with ease and light enough to be handled just as easily. With a choice of three different blade sizes, you can find the right one to suit your garden.**

### **Ease of use**

Each model has an easy to operate five position cutter deck height adjustment control. So you can achieve a perfect cut every time, by selecting the ideal height to suit your grass.

### **Performance**

The HRE 370 and 410 models both feature our unique Optiflow system. This utilises a specially designed fan, fixed to the blade, creating a powerful, controlled airflow that maximises grass collection.

### **Comfort and control**

A magnetic blade brake clutch system is conveniently operated from the main handle, making it easy to engage and disengage the cutting blades whilst an integrated cable loop system keeps the cable out of harms way.



HRE 330 PLE



## HRG lawnmowers

# Izy. The light and versatile mower

Lightweight, robust and easy to use, the Izy can turn in the tightest spaces making it perfect for small and medium sized gardens. The range includes the choice of either push-type, single speed or SMART Drive® self propelled machines.



Cutter height adjustment with 6 positions

### HRG SPECIFICATION

Models	Cutter deck size (cm) & material	TRANSMISSION					MULCHING				
		Fixed		Variable			Mulching Kit	Versamow™ (Selective)	Versamow™ (Variable)	Electric start	Roto-stop®
		Push	Single speed	SMART Drive®	Select Drive	Hydrostatic Drive					
HRG 416 PKEH	41 Steel	■									
HRG 416 SKEH			■				○				
HRG 466 PKEH	46 Steel	■					○				
HRG 466 SKEH			■				○				
HRG 466 SKEP			■					■			
HRG 536 SKEH	53 Steel		■				○				
HRG 536 VKEH				■				■			
HRG 536 VLEA					■					■	
HRG 536 VYEH					■				■		■

Model availability is dependant on country, do not hesitate to ask your local Honda dealer.

○ Available as an optional extra



Auto-Choke



SMART Drive®\*\*



Versamow™ Selective Mulching System\*



Roto-Stop®\*\*\*



Electric Start\*\*\*\*



\*Available on HRG 536 VKEH, VLEA and VYEA models only.  
\*\*Available on HRG 466 SKEP and HRG 536 VKEH, VLEA & VYEA models only.  
\*\*\*Available on HRG 536 VYEH only.  
\*\*\*\*Available on HRG 536 VLEA only.



Convenient electric start (HRG 536 VLEA)

### Ease of use

The engine is easy to start with an auto-choke and soft grip recoil control, conveniently mounted on the sturdy handle bar. This handle bar can be positioned for maximum comfort, via a three way adjusting system, then quickly folded down to save space when stored. The cutting height can be set to six different positions for optimum performance, with separate front and rear controls.

### Performance

The pressed steel, powder coated cutter deck is lightweight for manoeuvrability, whilst extremely hard wearing and resistant to deterioration from corrosion and UV rays. To optimise the collecting performance, all Izy mowers have high airflow collection bags which maximises grass pick-up.

### Comfort and control

Available with single fixed speed as well as our ergonomically designed SMART Drive® variable speed control, all Izy mowers are easy to use and control. We build them to our own exacting standards for longevity and reliability, meaning you can enjoy using them for many years to come.



HRG 416 SKEH

HRG 536 VKEH



# HRX lawnmowers

## Enjoy the choice

The HRX is a wide range of technologically advanced mowers, from a push-type to our unique SMART Drive® and variable speed models. All have Honda's reliable 4-stroke power and a special high tech polymer cutter deck, which is light, resistant to UV rays and will not rust. All you need to do is pick the one that is right for your lawn.



Central lever cutter deck adjustment (only on HRX 476)

High airflow grass airbag

### HRX SPECIFICATION

Models	Cutter deck size (cm) & material	TRANSMISSION					MULCHING					
		Fixed		Variable			Mulching Kit	Versamow™ (Selective)	Versamow™ (Variable)	Electric start	Roto-stop®	Rear roller
		Push	Single speed	SMART Drive®	Select Drive	Hydrostatic Drive						
HRX 426 PKEH	42 Polystrong	■					○					
HRX 426 SDEH			■				○					
HRX 426 SXEH			■				○				■	
HRX 426 QXEH			■								■	■
HRX 476 VKEH	47 Polystrong			■								
HRX 476 VYEH				■							■	
HRX 476 HYEH						■					■	
HRX 476 QXEH			■								■	■
HRX 537 VKEA	53 Xenoy				■							
HRX 537 VYEA					■						■	
HRX 537 HYEA						■					■	
HRX 537 HZEA						■				■	■	

Model availability is dependent on country, do not hesitate to ask your local Honda dealer.

○ Available as an optional extra



\*Available on selected models only, please see table below for details.  
 \*\*Available on HRX 537 HZEA model only.  
 \*\*\*Available on HRX 426 QXEH & HRX 476 QXEH models only.



### Ease of use

With the cutter deck adjuster situated on a single easy to use handle, you can effortlessly lower or raise the deck evenly over all four wheels for an accurate cut (only on HRX 476). Specially designed offset MicroCut twin-blades work efficiently to cut the grass cuttings into ultra-fine particles and recycle them back into your lawn, creating a natural fertiliser. The Versamow™ variable mulching system is easily operated by a multi-position lever to select the perfect ratio between collecting and mulching (only available on certain models).

### Performance

Our blades are designed to twist, not break, should you hit a solid obstacle while mowing. This Honda innovation not only increases safety, it also prevents

further damage to the engine and the cutter deck. With Honda's Roto-stop® technology you can disengage the blade without having to cut the engine. That means you don't have to stop and restart the engine every time you go over gravel or empty the grass bag.

### Comfort and control

Available with a choice of single speed, SMART Drive® or Select Drive as well as variable Hydrostatic Drive, there is a transmission system ideally suited to you and your garden. The handle bars can be adjusted using the four-way system to ensure a comfortable working position.



HRX 537 VYEA





\*Available on HRS 536 VKEA model only.  
 \*\*Available on selected models only, please see table below for details.



### SPECIFICATIONS

Models	Cutter deck size (cm) & material	TRANSMISSION					MULCHING					
		Fixed		Variable			Mulching Kit	Versamow™ (Selective)	Versamow™ (Variable)	Electric start	Roto-stop®	Roller type
		Push	Single speed	SMART Drive®	Triple speed	Hydrostatic Drive						
<b>HRS</b>												
HRS 536 VKEA	53 Steel			■			Side discharge or mulching					
<b>HRD</b>												
HRD 536 HXE	53 Aluminium					■	○					■
HRD 536 TXEH					■		○					■
HRD 536 QXE		■										■
<b>HRH</b>												
HRH 536 HXE	53 Aluminium					■	○					■
HRH 536 QXE		■					○					■

Model availability is dependent on country, do not hesitate to ask your local Honda dealer.

○ Available as an optional extra



## Professional lawnmowers

# Hard working mowers for hard working professionals

The HRD and HRH mowers, with our powerful Pro Spec engines and 53cm wide heavy duty cast aluminium cutter decks are robust, reliable and designed to meet the most demanding conditions. So if you require a mower that you can depend on, this is the professional choice.



Pro Spec GXV 160 engine

Reinforced cutter deck handle



Cast iron drive shaft

### Outstanding performance

Protected by a tough cast aluminium deck and a reinforced cutter deck handle, the HRD and HRH are built to take on the most demanding jobs time after time. Power comes from our Pro Spec GXV 160 engines (except HRD 536 TXEH), which have a durable cast iron cylinder sleeve and crankshaft, that runs on specially adapted bearings to extend its working life. They also feature dual air filters and an extra large 1.5 litre fuel tank for periods of extended use.

### A full professional range

Whatever the task, we have just the right mower to get the job done. The HRS, for instance, is designed to make short work of long grass, mulching clippings and blowing them back onto the lawn. It also has the ability to eject grass clippings from a side chute.

Our UM grass cutters are built for areas that are difficult to manage, like fields, orchards and roadsides. The free floating front wheels and hydrostatic transmission make work easy and safe.



HRD 536 TXEH

HRH 536 HXEA









HRS 536 VKEA

UM 536 EE



# Lawnmower specification

Use our handy table to compare our lawnmowers and choose the right model for you.

	ELECTRIC			IZY				
	HRE 330 PLE	HRE 370 PLE	HRE 410 PE	HRG 416 PKEH	HRG 416 SKEH	HRG 466 PKEH	HRG 466 SKEH	HRG 466 SKEP
								
Cutter deck size (cm)	33	37	41	41	41	46	46	46
Cutter deck material	Polyprop. Plastic	Polyprop. Plastic	ABS Plastic	Steel	Steel	Steel	Steel	Steel
Engine	Electric 1100 W	Electric 1300 W	Electric 1600 W	OHC 4-stroke	OHC 4-stroke	OHC 4-stroke	OHC 4-stroke	OHC 4-stroke
Engine displacement (cc)	-	-	-	160	160	160	160	160
Engine model	-	-	-	GCV 160	GCV 160	GCV 160	GCV 160	GCV 160
Engine rated power (KW/rpm)*	-	-	-	2.8/2,900	2.8/2,900	2.7/2,800	2.7/2,800	2.7/2,800
Dual air filter	-	-	-	-	-	-	-	-
Engine bearings	-	-	-	-	-	-	-	-
Fuel tank capacity (l)	-	-	-	0.91	0.91	0.91	0.91	0.91
Transmission	Push	Push	Push	Push	Single speed	Push	Single speed	Single speed
Driving speed (m/s)	-	-	-	-	0.92	-	0.89	0.89
Blade brake clutch (Roto-stop®)	-	-	-	-	-	-	-	-
Mulching (Versamow™-selective / variable)	-	-	-	-	-	-	-	Selective
Mulching kit	-	-	-	-	Optional	Optional	Optional	-
Positions & cutting height adjustment (mm)	3 (25-57)	5 (18-65)	5 (20-70)	6 (20-74)	6 (20-74)	6 (20-74)	6 (20-74)	6 (20-74)
Height adjustment points	1	1	2	2	2	2	2	2
Rear roller	-	-	-	-	-	-	-	-
Electric start	-	-	-	-	-	-	-	-
Grass bag capacity (l)	27	35	65	50	50	55	55	55
Guaranteed sound level dB(A)**	87	89	94	94	95	94	95	95
Dry weight (kg)	11.0	15.0	22.0	29.0	30.0	29.0	31.0	32.0
Dimensions (L x W x H (mm))	1,080 x 390 x 1,000	1,110 x 430 x 1,030	1,330 x 540 x 1,090	1,415 x 453 x 980	1,440 x 453 x 980	1,445 x 497 x 980	1,470 x 497 x 980	1,470 x 497 x 980

\*The power rating of engines in this document is the net power output tested on a production engine and measured in accordance with SAE J1349 at 3,600 rpm.

\*\*Guaranteed sound power level (in accordance with 2000/14/EC Directive) in dB(A).





IZY				HRX					
-----	--	--	--	-----	--	--	--	--	--

<b>HRG 536</b> SKEH	<b>HRG 536</b> VKEH	<b>HRG 536</b> VLEA	<b>HRG 536</b> VYEH	<b>HRX 426</b> PKEH	<b>HRX 426</b> SDEH	<b>HRX 426</b> SXEH	<b>HRX 426</b> QXEH	<b>HRX 476</b> VKEH	<b>HRX 476</b> VYEH
------------------------	------------------------	------------------------	------------------------	------------------------	------------------------	------------------------	------------------------	------------------------	------------------------



53	53	53	53	42	42	42	42	47	47
Steel	Steel	Steel	Steel	Polystrong	Polystrong	Polystrong	Polystrong	Polystrong	Polystrong
OHC 4-stroke	OHC 4-stroke	OHC 4-stroke	OHC 4-stroke	OHC 4-stroke	OHC 4-stroke	OHC 4-stroke	OHC 4-stroke	OHC 4-stroke	OHC 4-stroke
160	160	160	160	160	160	160	160	160	160
GCV 160	GCV 160	GCV 160	GCV 160	GCV 160	GCV 160	GCV 160	GCV 160	GCV 160	GCV 160
2.7/2,850	2.7/2,850	2.7/2,850	2.7/2,850	2.8/2,900	2.8/2,900	2.8/2,900	2.8/2,900	2.7/2,800	2.7/2,800
-	-	-	-	-	-	-	-	-	-
-	-	-	-	-	-	-	-	-	-
0.91	0.93	0.93	0.93	0.91	0.91	0.91	0.91	0.91	0.91
Single speed	Variable SMART Drive®	Variable SMART Drive®	Variable SMART Drive®	Push	Single speed	Single speed	Single speed	Variable SMART Drive®	Variable SMART Drive®
0.77	0-1.65 (progressive)	0-1.65 (progressive)	0-1.65 (progressive)	-	1.04	1.04	0.90	0-1.40	0-1.40
-	-	-	Yes	-	-	Yes	Yes	-	Yes
-	Selective	Selective	Selective	-	-	-	-	Variable	Variable
Optional	-	-	-	Optional	Optional	Optional	-	-	-
6 (19-80)	6 (28-102)	6 (28-102)	6 (28-102)	6 (25-78)	6 (25-78)	6 (25-78)	5 (19-55)	7 (25-79)	7 (25-79)
4	4	4	4	2	2	2	2	1	1
-	-	-	-	-	-	-	Yes	-	-
-	-	Yes	-	-	-	-	-	-	-
61	73	73	73	60	60	60	60	69	69
98	98	98	98	94	94	94	94	95	95
36.2	36.8	40.2	41.3	31.0	33.0	36.0	38	39.0	42.0
1,637 x 585 x 970	1,534 x 582 x 1,014	1,534 x 582 x 1,014	1,534 x 582 x 1,014	1,475 x 480 x 995	1,475 x 480 x 995	1,440 x 480 x 1,030	1,440 x 480 x 1,045	1,545 x 530 x 960	1,545 x 530 x 960

Model availability is dependant on country, do not hesitate to ask your local Honda dealer.



# Lawnmower specification

Use our handy table to compare our lawnmowers and choose the right model for you.











	HRX						HRS	HRD
	HRX 476 HYEH	HRX 476 QXEH	HRX 537 VKEA	HRX 537 VYEA	HRX 537 HYEA	HRX 537 HZE A	HRS 536 VKEA	HRD 536 HXE
Cutter deck size (cm)	47	47	53	53	53	53	53	53
Cutter deck material	Polystrong	Polystrong	Xenoy	Xenoy	Xenoy	Xenoy	Steel	Aluminium
Engine	OHC 4-stroke	OHC 4-stroke	OHC 4-stroke	OHC 4-stroke	OHC 4-stroke	OHC 4-stroke	OHC 4-stroke	OHV 4-stroke
Engine displacement (cc)	160	160	187	187	187	187	160	163
Engine model	GCV 160	GCV 160	GCV 190	GCV 190	GCV 190	GCV 190	GCV 160	GXV 160
Engine rated power (KW/rpm)*	2.7/2,800	2.7/2,750	3.2/2,850	3.2/2,850	3.2/2,850	3.2/2,850	2.7/2,850	2.7/2,800
Dual air filter	-	-	-	-	-	-	-	-
Engine bearings	-	-	-	-	-	-	-	-
Fuel tank capacity (l)	0.91	0.91	0.93	0.93	0.93	0.93	0.93	1.5
Transmission	Variable Hydrostatic	Single speed	Variable Select Drive	Variable Select Drive	Variable Hydrostatic	Variable Hydrostatic	Variable SMART Drive®	Variable Hydrostatic
Driving speed (m/s)	0-1.40	1.00	0-1.64	0-1.64	0-1.61	0-1.61	0.98	0-1.40
Blade brake clutch (Roto-stop®)	Yes	Yes	-	Yes	Yes	Yes	-	Yes
Mulching (Versamow™-selective/variable)	Variable	-	Variable	Variable	Variable	Variable	-	-
Mulching kit	-	-	-	-	-	-	-	Optional
Positions & cutting height adjustment (mm)	7 (25-79)	5 (19-58)	7 (19-101)	7 (19-101)	7 (19-101)	7 (19-101)	6 (26-88)	5 (14-52)
Height adjustment points	1	1	4	4	4	4	4	4
Rear roller	-	Yes	-	-	-	-	-	-
Electric start	-	-	-	-	-	Yes	-	-
Grass bag capacity (l)	69	73	85	85	85	85	-	80
Guaranteed sound level dB(A)**	95	94	98	98	98	98	98	98
Dry weight (kg)	44.0	42.0	40.1	43.9	44.7	46.4	31.1	49.3
Dimensions (L x W x H (mm))	1,610 x 530 x 1,035	1,520 x 530 x 1,055	1,638 x 585 x 1,016	1,638 x 585 x 1,016	1,825 x 585 x 1,115	1,825 x 585 x 1,115	1,621 x 585 x 948	1,575 x 574 x 1,018

\*The power rating of engines in this document is the net power output tested on a production engine and measured in accordance with SAE J1349 at 3,600 rpm.

\*\*Guaranteed sound power level (in accordance with 2000/14/EC Directive) in dB(A).





HRD			HRH		GRASS CUTTER			
HRD 536 HXEA	HRD 536 TXEH	HRD 536 QXE	HRH 536 HXE	HRH 536 QXE	UM 536 EE2	UM 536 EBE2	UM 616 EE2	UM 616 EBE2
								
53	53	53	53	53	53	53	61	61
Aluminium	Aluminium	Aluminium	Aluminium	Aluminium	Steel	Steel	Steel	Steel
OHC 4-stroke	OHC 4-stroke	OHV 4-stroke	OHV 4-stroke	OHV 4-stroke	OHV 4-stroke	OHV 4-stroke	OHV 4-stroke	OHV 4-stroke
160	160	163	163	163	163	163	163	163
GCV 160	GCV 160	GXV 160	GXV 160	GXV 160	GXV 160	GXV 160	GXV 160	GXV 160
2.7/2,800	2.7/2,800	2.7/2,800	2.7/2,800	2.7/2,800	3.2/3,600	3.2/3,600	3.2/3,600	3.2/3,600
-	-	-	Yes	Yes	-	-	-	-
-	-	-	Yes	Yes	-	-	-	-
0.91	0.91	1.5	1.5	1.5	1.6	1.6	1.6	1.6
Variable Hydrostatic	Three Speed	Single speed	Variable Hydrostatic	Single speed	Two speed	Two speed	Variable Hydrostatic	Variable Hydrostatic
0-1.40	0.80, 1.20 & 1.30	1.20	0-1.40	1.20	0.50 & 0.80	0.50 & 0.80	0.40-1.00	0.40-1.00
Yes	Yes	Yes	Yes	Yes	Yes	Yes	Yes	Yes
-	-	-	-	-	-	-	-	-
Optional	Optional	Optional	Optional	Optional	-	-	-	-
7 (14-76)	7 (14-76)	5 (14-52)	6 (21-76)	5 (14-52)	4 (25-85)	4 (25-85)	4 (20-80)	4 (20-80)
4	4	4	4	1	2	2	2	2
-	-	Yes	-	Yes	-	-	-	-
-	-	-	-	-	-	-	-	-
80	80	83	83	83	-	-	-	-
97	97	98	98	98	98	98	98	98
46.2	45.2	53.5	61.0	59.0	63.0	68.0	72.0	76.0
1,575 x 574 x 1,018	1,575 x 574 x 1,018	1,655 x 574 x 1,031	1,695 x 575 x 1,020	1,695 x 575 x 1,020	1,780 x 860 x 1,080	1,780 x 860 x 1,080	1,790 x 970 x 1,080	1,790 x 970 x 1,080

Model availability is dependant on country, do not hesitate to ask your local Honda dealer.



# Honda ride-on mower and lawn tractor benefits



Our ride-on mower range is packed with innovative, robust features that maximise cutting and collecting performance while ensuring they are enjoyable to use. From the compact HF 1211 to the premium HF 2622, you can find the right machine for you.





## Optiflow

Our Research and Development team has developed Honda Optiflow, a system that combines powerful suction with controlled and low turbulence air flow that reduces power loss, noise and grass accumulation, from the air intake **1** through the cutter deck **2** to the grass ejection **3** in the grass bag **4**. The air flow is powerful and constant enough to completely fill the grass bag whilst minimising dust.



## Synchronised blade belt system

Cutter decks with asynchronous blades use two independent unsynchronised blades that are slightly offset. Cutter decks with synchronous blades use two blades that are synchronised with a timing belt to keep a constant 90 degree angle. The benefit of a synchronous system is constant cutting performance to avoid uncut areas, even when turning and allows better air flow under the cutter deck, resulting in optimised grass collecting and a lower risk of clogging.

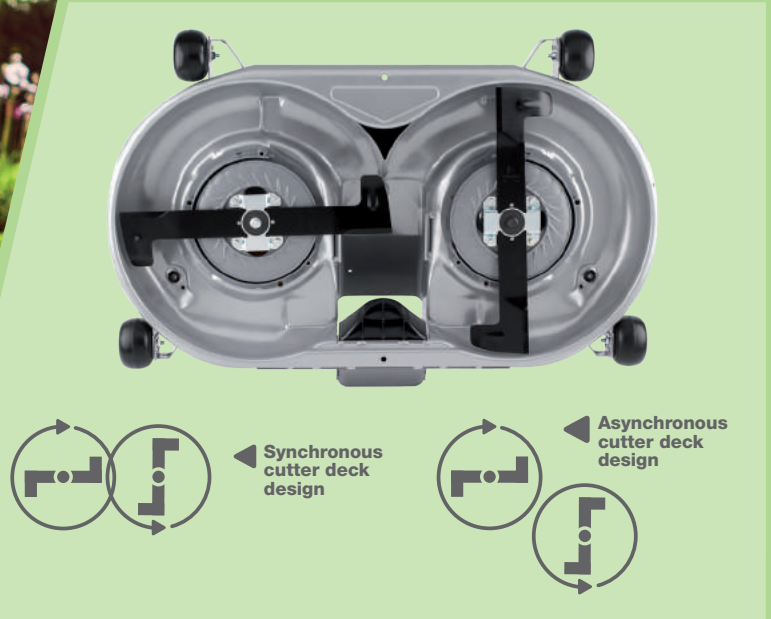

## Versamow™ selective

With a single lever, Honda's Versamow™ selective mulching system will either collect the grass cuttings into the bag or finely shred and blow them down into the lawn to create a natural fertiliser. If your grass is long or rough, you can mow your garden and collect grass clippings in one passage.



## Honda engine

Reliability, performance and cleaner exhaust gas emissions are the hallmark of Honda V-twin engines. Each model includes a decompressor for an easy start (and easy restart), and is one of the most fuel efficient engines on the market. The cast iron cylinder sleeve and the high capacity air filter ensure a long lifetime on even the toughest of workloads.



## HF ride-on mowers and lawn tractors

# Manoeuvrability and ease of use

The HF 1211 ride-on mower and HF 2315 lawn tractors are designed for larger lawns. They have excellent performance and are highly manoeuvrable. All make grass cutting effortless, with hydrostatic transmission and a grass box emptying lever, easily accessed from the comfort of your driving seat.



Hydrostatic transmission for an incomparable user experience

Optiflow offers an optimised collection capacity

### SPECIFICATION

Models	CUTTER DECK SIZE cm	ENGINE		TRANSMISSION		MULCHING		GRASS BAG CONTROL	
		GXV 340	GCV 520	Mechanical	Hydrostatic Drive	Mulching Kit	Versamow™	Manual	Electric
<b>RIDER</b>									
HF 1211 HE	71	■			■	○		■	
<b>HF</b>									
HF 2315 HME	92		■		■	○		■	

○ Available as an optional extra



Hydrostatic Drive\*

Optiflow\*\*



\*Available on HF 1211 HE and HF 2315 HME models only.  
\*\*Available on HF 2315 HME model only.



### Ease of use

The HF 1211 HE and HF 2315 HME are easily controlled by a single pedal that controls the hydrostatic forward speed. They are also highly manoeuvrable, with a tight turning circle and excellent visibility which makes cutting around obstacles simple. To save time and effort whilst working, a single, easy to reach lever can empty the grass bag box from the comfort of the driving seat.

### Performance

Equipped with our Pro Spec engines, the HF 2315's feature cast iron cylinder sleeves and crankshaft bearings for smooth running and longer engine life. These machines are reliable and provide outstanding performance time after time.

### Comfort and control

We have designed the HF 1211 and HF 2315 to be intuitive to use and easy to operate. From your comfortable seating position you'll find all the important controls within easy reach, so you can cut large areas of grass with the minimal effort and time. The hydrostatic transmission gives you smooth, variable speed, and the ability to regulate your pace without affecting the blade speed. That way you get a perfect result, whether you're in a hurry or taking your time.



HF 1211 HE





\*Available on HF 2417 HME/HTE & HF 2622 HME/HTE models only.  
 \*\*Available on HF 2622 HME/HTE models only.  
 \*\*\*Available on HF 2417 HTE & HF 2622 HTE models only.



**SPECIFICATION**

	CUTTER DECK SIZE		ENGINE		TRANSMISSION		MULCHING		GRASS BAG CONTROL	
	cm	cm	GCV 530	GXV 660	Mechanical	Hydrostatic Drive	Mulching Kit	Versamow™	Manual	Electric
<b>HF</b>										
HF 2417 HBE	102		■			■	○		■	
HF 2417 HME	102		■			■		■	■	
HF 2417 HTE	102		■			■		■		■
HF 2622 HME		122		■		■		■	■	
HF 2622 HTE		122		■		■		■		■

○ Available as an optional extra



## HF premium lawn tractors

# Premium comfort and performance

As you would expect from our flagship range of lawn tractors, the HF 2417 and HF 2622 series deliver outstanding performance from their V-Twin engines and are designed and built to take on any lawn.

They are robust, reliable and user friendly, with Versamow™ selective mulching, a tough bumper for protection and a cast iron front axle, that provides strength to the chassis and enhances the steering.

Versamow™ selective mulching



Control panel



Cast iron front axle and bumper



### Ease of use

If you're passionate about gardening, our lawn tractors will take the effort out of keeping your grass in perfect condition. The electromagnetic blade brake clutch for instance, makes it simple to switch between activating and deactivating the cutting blade and, with a maximum 350 litre capacity grass bag, you can continue mowing for longer.

### Performance

A unique Optiflow system created by Honda, provides the ultimate collecting performance, meaning there is no clogging in the collection chute. The cutting blades have an overlapping cutting area to create accurate mowing and avoid any uncut areas when turning. The powerful torque developed by the V-twin engine, combined with Hydrostatic Drive, will take you smoothly along at a pace you're happy with, without affecting the quality of the cut.

### Comfort and control

With options such as the electric grass bag emptying, these tractors provide the ultimate lawn care experience with superior driving comfort. Whilst our unique Versamow™ technology, which allows you to select whether you collect or mulch, can be operated by a single lever from your driving seat. The large tyres, with lawn protecting tread, ensure not only good traction but that no unsightly damage is done.





HF 2622 HTE



# Ride-on mower and lawn tractor specification

Use our handy table to compare our ride-on mowers and lawn tractors and choose the right model for you.

	RIDE-ON	LAWN TRACTORS	PREMIUM LAWN TRACTORS
	HF 1211 HE	HF 2315 HME	HF 2417 HBE
			
Cutter deck size (cm)	71	92	102
Engine	OHV 4-stroke	OHC V-twin 4-stroke	OHC V-twin 4-stroke
Engine displacement (cc)	337	530	530
Engine model	GXV 340	GCV 520	GCV 530
Engine rated power (KW/rpm)*	6.4/3,100	9.4/2,800	9.9/2,800
Fuel tank capacity (l)	3.6	5.4	5.4
Guaranteed sound power level dB(A)**	100	100	100
Transmission type	Variable Hydrostatic	Variable Hydrostatic	Variable Hydrostatic
Driving speed (km/h)	0-8.00	0-8.2	0-8.20
Optiflow	-	Yes	Yes
Number of blades	1	2	2
Blade positioning	-	Asynchronous	Synchronous
Blade brake clutch	Mechanical	Electromagnetic	Electromagnetic
Grass bag dumping	Manual	Manual	Manual
Positions & cutting height adjustment (mm)	7 (30-80)	7 (30-80)	7 (30-90)
Grass bag capacity (l)	170	280	300
Mulching (Versamow™ selective mulching)	-	-	-
Mulching kit	o	o	o
Rear deflector	-	o	o
Dry weight (kg)	172	219	237
Dimensions (L x W x H (mm))***	1,863 x 760 x 1,100	2,440 x 970 x 1,230	2,440 x 1,060 x 1,230
Front / rear tyres (diameter x width - rim (inch))	11 x 4.4 / 15 x 6.6	13 x 5.0 - 6.0 / 18 x 8.5-8.0	15 x 5.0 - 6.0 / 18 x 8.5-8.0
Turning radius (m)	1.4	1.8	1.8
Tow hitch	-	o	o

Standard • Optional o Not available -





## PREMIUM LAWN TRACTORS

**HF 2417**  
HME



**HF 2417**  
HTE



**HF 2622**  
HME



**HF 2622**  
HTE



102	102	122	122
OHC V-twin 4-stroke	OHC V-twin 4-stroke	OHV V-twin 4-stroke	OHV V-twin 4-stroke
530	530	688	688
GCV 530	GCV 530	GXV 660	GXV 660
9.9/2,800	9.9/2,800	13.9/2,800	13.9/2,800
8.5	8.5	8.5	8.5
100	100	105	105
Variable Hydrostatic	Variable Hydrostatic	Variable Hydrostatic	Variable Hydrostatic
0-8.20	0-8.20	0-8.20	0-8.20
Yes	Yes	Yes	Yes
2	2	2	2
Synchronous	Synchronous	Synchronous	Synchronous
Electromagnetic	Electromagnetic	Electromagnetic	Electromagnetic
Manual	Electric	Manual	Electric
7 (30-90)	7 (30-90)	7 (30-90)	7 (30-90)
300	300	350	350
Yes	Yes	Yes	Yes
-	-	-	-
o	o	o	o
239	250	263	272
2,445 x 1,060 x 1,230	2,445 x 1,060 x 1,230	2,445 x 1,260 x 1,230	2,445 x 1,260 x 1,230
15 x 5.0 - 6.0 / 18 x 8.5-8.0	15 x 5.0 - 6.0 / 18 x 8.5-8.0	15 x 5.0 - 6.0 / 18 x 8.5-8.0	15 x 5.0 - 6.0 / 18 x 8.5-8.0
1.8	1.8	1.6	1.6
o	o	o	o



\*The power rating of engines in this document is the net power output tested on a production engine and measured in accordance with SAE J1349 at 3,600 rpm.

\*\*Guaranteed sound power level (in accordance with directives 2000/14/EC, 2005/88/EC).

\*\*\*Dimensions: L - including grass bag, W - including cutter deck. Model availability is dependant on country, do not hesitate to ask your local Honda dealer.



# Honda cordless range benefits

## Cordless range

The Honda cordless range revolutionises gardening, with the use of one high performance interchangeable battery that is used to power any of the three Honda tools.

So hedge trimming, leaf blowing and lawn trimming can be accessed in any part of your garden without a cord. The specific 56 volt Honda batteries offer a long runtime, with a quiet and exhaust-free energy supply.

All the machines are easy to use, you just need to plug and play.





## Lithium-ion batteries

The Honda 56 volt lithium-ion batteries offer high capacity power storage in an extremely compact and lightweight format. Furthermore, they generate as much power at low capacity as they do when fully charged.

2 batteries (2.0 Ah and 4.0 Ah) and 2 chargers (210 W and 550 W) are available in the range.

## Balance

Whatever the product, the position of the battery has been optimised to ensure the best balance when in use. Excellent ergonomics and handling ensure high comfort for the user, even over long periods of work.



## Plug & play

The plug and play system offers an easy method of attaching the battery via runners, which guide it into the correct and safe position. With an audible click, the battery is engaged and ready to be used.



## V-shape batteries

Both battery models feature arch-shaped designs in order to provide a larger surface area for better cooling. This enables faster charging, higher output and a longer lifespan for your battery.





61 cm laser-cut blades for ultimate performance and precision

SPECIFICATION		
	2.0 Ah battery	4.0 Ah battery
MODELS	RUNNING TIME	
HEDGETRIMMER	up to 65 min	up to 130 min
LAWN TRIMMER	up to 28 min	up to 50 min
LEAF BLOWER (High mode)	up to 18 min	up to 31 min
	CHARGING TIME	
STANDARD CHARGER	40 min	80 min
FAST CHARGER	25 min	30 min

Running time for information only, many factors can affect the performance.



The lawn trimmer is equipped with tap and go technology. Just hit the head on the ground to feed the nylon thread



Cordless range

No Cord  
No Limits

*The leaf blower has 3 modes which offer 3 different airstream speeds*



**The Honda cordless range offers you the freedom to care for your garden without being tethered to an electricity supply. All these products have an interchangeable, independent and rechargeable battery pack that just clicks in and you are ready to get to work.**

#### **Hedgetrimmer**

The Honda cordless hedgetrimmer is equipped with 61 cm laser-cut steel blades that give smooth, precise operation with a super-sharp edge. Thanks to the dual action blades, the product can cut back and forth comfortably, with no need to turn the trimmer upside down. Even with the 2.0 Ah battery, the machine can offer more than one hour of working on dense and rough hedges.

#### **Lawn trimmer**

The Honda cordless lawn trimmer is perfect for tidying lawn edges, clearing long grass and dense foliage. Its balanced weight distribution ensures it's safe and effortless to use, while a variable speed control provides comfort and control to the user. A clever tap and go head feature feeds the nylon thread during use, allowing you to spend more time cutting, not stopping to re-thread the line.

#### **Leaf blower**

Compact and lightweight, the Honda blower features a powerful turbine fan capable of producing a 91 mph (147km/h) airstream. Which means it's powerful enough to shift even heavy and wet debris. It has three settings: low, high and turbo to control the air speed - perfect for clearing lawns, paths, patios and driveways.



## Honda handheld benefits



### **Honda 4-stroke engine**

The mini Honda 4-stroke GX25 and GX35 engines offer the performance you expect from larger engines, with strong torque available across the entire rev range, but in a very compact package.

These engines power the Honda handheld product range and have satisfied millions of customers around the globe. They are quiet and convenient to use, with minimal vibration levels and low emissions, with the added feature of not requiring a pre-mix of oil and fuel.



## Decompression system

The GX25 and GX35 are equipped with a mechanical decompression system combined with a super-lightweight flywheel which requires minimal effort on the pull-cord to start the engine.

## 360° lubrication

These engines feature a rotary slinger pumping lubrication system which provides a constant flow of lubrication whatever the position of the engine. This makes usage and storage very convenient.

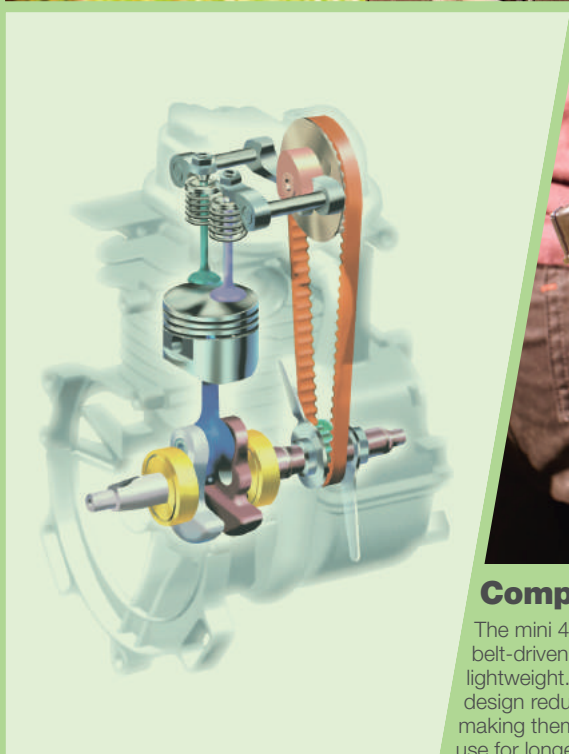

## Compact design

The mini 4-stroke Honda engines have a belt-driven OHC design which is compact and lightweight. In addition, the 4-stroke engine design reduces unpleasant mechanical noise, making them quieter and more comfortable to use for longer periods.

## High fuel efficiency

Whatever the application, these engines offer long running time between filling through their optimised fuel tank and low fuel consumption.

Fuel consumption at maximum power:  
Honda GX25 0.54 litre/hour at 7,000 rpm  
Honda GX35 0.71 litre/hour at 7,000 rpm





*The semi-automatic tap and go head feeds nylon line by simply tapping the head on the ground while using the brushcutter*

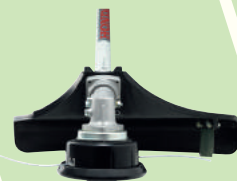

		UMK SPECIFICATION				UMR SPECIFICATION	UMS SPECIFICATION
		MODELS					
		UMK 425 UE	UMK 435 UE	UMK 425 LE	UMK 435 LE	UMR 435 LE	UMS 425 LN
SHAFT	Straight	■	■	■	■		
	Bent						■
	Flexible					■	
ENGINE	GX 25	■		■			■
	GX 35		■		■	■	
HANDLE	D-loop			■	■	■	■
	Bike type	Variable	■	■			
ACCESSORIES INCLUDED	Tap and go nylon head	■	■	■	■	■	■
	3 tooth blade	■	■	■	■	■	
	Harness	■	■	■	■	■	
	Protection glasses	■	■	■	■	■	■

### Sturdiness

The transmission is cast in aluminium to offer better shock resistance and higher reliability. The machine works through a 6 splined transmission shaft to ensure maximised torque transmission and reduced shaft breakage. They feature a non-contact sealing bearing which significantly increases the lifetime and dust proof performance.

### Comfort and performance

The Honda 4-stroke engines are not only the most compact and reliable of their kind, but they help to reduce mechanical noise, vibration and emissions.



## Handheld brushcutters

# Ready for heavy-duty work

Designed to be as comfortable to use as they are powerful. Delivering reliable, constant power and torque in the most demanding environments.



*Hedgetrimmer\**



*3 tooth blade\**



*4 tooth blade\**

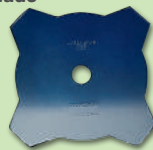

*Pruner\**



\*Accessory only

They are extremely manoeuvrable and come with an adjustable harness for maximum comfort. Bi-injected plastic and rubber handles offer excellent grip, whilst the bike type model can be adjusted on two planes without any tools, to find the most suitable and balanced position.

### A full range

A backpack brushcutter has been designed to make prolonged use more comfortable whilst offering complete manoeuvrability through a flexible shaft. It features a combination spring, which has been specifically designed to absorb the vibration from the engine.

Our bent shaft brushcutter comes fitted with the tap and go nylon head. Its light, well-balanced proportions enable you to control the unit easily as you work – so reaching really tricky spots is much easier.





## Handheld Versatool™

# The garden power tool that does it all

The Versatool™ is designed to take on a huge range of garden tasks. With eight push-and-click attachment options and a 4-stroke engine at its heart, it's the ultimate power tool for gardening perfection.



*Extensions*



*Edger*



*Hedgetrimmer*



*Blower*



*Pruner*



*Cultivator*





*Linecutter*

*Change your tools in one click*



*3 tooth blade*

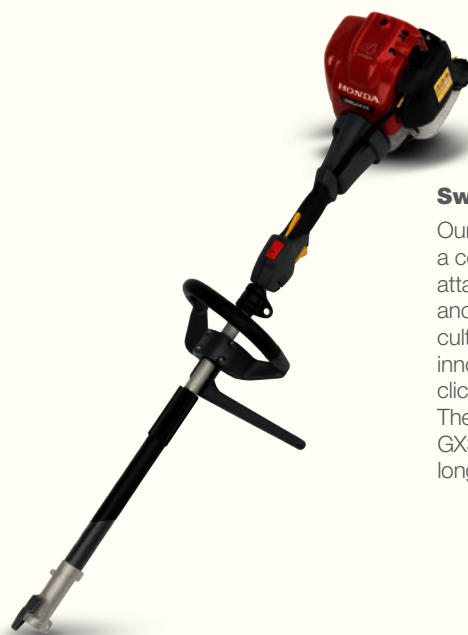

**UMC 435 E / 425 E**

**Switch, lock and go**

Our multipurpose Versatool™ features a comprehensive range of interchangeable attachments, from pruners, hedgetrimmers and linecutters to blowers, edgers and cultivators. All are easily attached via our innovative joint system: Simply push and click to lock your preferred attachment. The Versatool™ is available with a GX25 or GX35 engine which will guarantee a very long product lifespan.



## Handheld hedgetrimmer and leaf blower

### Blow and cut with ease

Both our handheld hedgetrimmer and leaf blower have the benefit of the unrivalled Honda GX25 engine, to make light work of the numerous jobs they can do in your garden.







HHB 25 E

#### **Perfect cutting finish**

Honda hedgetrimmers are designed for accurate trimming in gardens and parks. The 75 cm length double blade ensures fast and efficient work through a high bending performance. The ergonomically comfortable controls, adjustable handle, low vibration frame, and reliable 4-stroke engine make Honda hedgetrimmers indispensable.

#### **Compact and powerful blower**

The compact Honda lightweight blower is ideal for keeping gardens, parks, stadiums and streets neat and tidy all year round. The airflow can reach 600 m<sup>3</sup>/h which allows it to blow heavy and wet debris. Its cruise

control feature allows you to maintain the engine speed without having to hold the trigger – great for using it over long periods of time.

#### **Astonishing GX25**

The Honda micro engine is very different from competitor's petrol handheld products. The mechanical decompression system offers easy starting, whilst its 360° lubrication system allows you to work and store the machine in any position. The engine is designed to run smoothly with little vibration and low noise. You can trust your Honda engine.



# Handheld specification

Use our handy table to compare our handheld range and choose the right model for you.

	BRUSHCUTTERS						VERSATOOL™	
	UMK 425 LE	UMK 435 LE	UMK 425 UE	UMK 435 UE	UMR 435 T	UMS 425	UMC 425 E	UMC 435 E
								
Engine	4-stroke OHC	4-stroke OHC	4-stroke OHC	4-stroke OHC	4-stroke OHC	4-stroke OHC	4-stroke OHC	4-stroke OHC
Engine displacement (cc)	25	35	25	35	35	25	25	35
Engine model	GX25T	GX35T	GX25T	GX35T	GX35T	GX25T	GX25T	GX35T
Engine net power (kW/rpm)	0.72/7,000	1.0/7,000	0.72/7,000	1.0/7,000	1.0/7,000	0.72/7,000	0.72/7,000	1.0/7,000
Fuel tank capacity (litres)	0.58	0.63	0.58	0.63	0.63	0.58	0.58	0.63
Engine oil capacity (litres)	0.08	0.10	0.08	0.10	0.10	0.08	0.08	0.10
Transmission type	Low vibration centrifugal clutch	Low vibration centrifugal clutch	Low vibration centrifugal clutch	Low vibration centrifugal clutch	Centrifugal clutch	Centrifugal clutch	Low vibration centrifugal clutch	Low vibration centrifugal clutch
Shaft type	Straight	Straight	Straight	Straight	Flexible	Bent	Straight	Straight
Handle	D-loop	D-loop	Bike type	Bike type	D-loop	D-loop	D-loop	D-loop
Grass cutter attachments: Tap & go nylon head	•	•	•	•	•	•	See table below for attachment specification	
Grass cutter attachments: 3 tooth blade	•	•	•	•	•	-		
Hedgetrimmer attachment	◦	◦	-	-	-	-		
Pruner attachment	◦	◦	-	-	-	-		
Optional attachments	-	-	4 tooth blade and saw blade	4 tooth blade and saw blade	-	-		
Harness	Double shoulder comfort	Double shoulder comfort	Double shoulder comfort	Double shoulder comfort	Double shoulder comfort	-	Single strap	Double strap
Noise value - sound power level dB(A)*	109	109	109	109	111	109	-	-
Dimensions (L x W x H (mm))	1,859 x 384 x 252	1,870 x 384 x 258	1,859 x 671 x 517	1,870 x 671 x 521	2,810 x 375 x 565	1,708 x 223 x 413	1,135 x 315 x 245	1,145 x 325 x 255
Dry weight (kg)	5.98	7.22	6.28	7.53	10.70	5.49	5.10	6.00
Additional feature	Heavy duty transmission head	Heavy duty transmission head	Heavy duty transmission head	Heavy duty transmission head	-	-	Joint system	Joint system

## VERSATOOL™ ATTACHMENTS

	Powerhead 25 cc	Powerhead 35 cc	Brushcutter	Cultivator	Extension - long	Extension - short	Hedgetrimmer - long	Hedgetrimmer - short	Pruner	Blower	Edger
Dimensions (L x H x W (mm))	1,708 x 310 x 245	1,145 x 315 x 258	770 x 400 x 210	795 x 235 x 255	1,060 x 65 x 52	559 x 65 x 52	1,400 x 120 x 120	900 x 120 x 120	1,070 x 140 x 88	860 x 264 x 190	695 x 330 x 145
Dry weight (kg)	5.60	6.40	1.85	3.30	1.10	0.70	2.60	2.35	2.10	2.10	2.05

Standard • Optional ◦ Not available -





HEDGETRIMMERS				BLOWER	CORDLESS RANGE		
---------------	--	--	--	--------	----------------	--	--

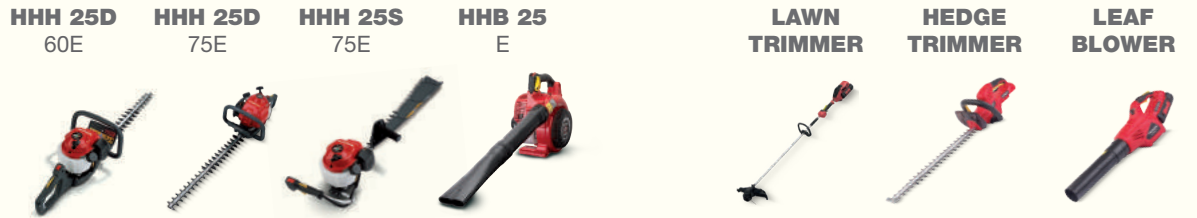

Engine	4-stroke OHC	4-stroke OHC	4-stroke OHC	4-stroke OHC
Engine displacement (cc)	25	25	25	25
Engine model	GX25T	GX25T	GX25T	GX25T
Engine net power (kW/rpm)	0.72/7,000	0.72/7,000	0.72/7,000	0.72/7,000
Fuel tank capacity (litres)	0.58	0.58	0.58	0.58
Engine oil capacity (litres)	0.08	0.08	0.08	0.08
Transmission type	Centrifugal clutch	Centrifugal clutch	Centrifugal clutch	-
Blade type (Dual / Single)	Dual	Dual	Single	-
Blade length (mm)	580	720	720	-
Blade spacing (mm)	36	36	36	-
Nominal air flow (with fan nozzle (m/sec))	-	-	-	600
Maximum wind speed (with fan nozzle (m/sec))	-	-	-	70
Noise value - sound power level dB(A)*	104	104	104	102
Dimensions (L x W x H (mm))	1,080 x 312 x 259	1,220 x 312 x 259	1,125 x 310 x 259	335 x 265
Dry weight (kg)	6.30	6.60	5.80	4.50
Additional feature	180° adjustable handle	180° adjustable handle	Clipping collector guard	Adjustable air flow

Motor	56V brushless DC	56V DC	56V brushless DC
Battery compatibility	Honda 2.0 Ah & 4.0 Ah batteries <sup>■</sup>	Honda 2.0 Ah & 4.0 Ah batteries <sup>■</sup>	Honda 2.0 Ah & 4.0 Ah batteries <sup>■</sup>
Weight (with battery)	4.3kg (with 2.0 Ah)	4.05kg (with 2.0 Ah)	3.6kg (with 2.0 Ah)
	5.24kg (with 4.0 Ah)	5.0kg (with 4.0 Ah)	4.55kg (with 4.0 Ah)
Noise**	76 dB(A) KPA=2.5 dB(A)	83 dB(A) KPA=2.5 dB(A)	82 dB(A) KPA=2.5 dB(A)
Vibration rear handle	1,011 m/s <sup>2</sup> K=1.5 m/s <sup>2</sup>	1,119 m/s <sup>2</sup> K=1.5 m/s <sup>2</sup>	1,067 m/s <sup>2</sup> K=1.5 m/s <sup>2</sup>
Vibration front handle	1,2421 m/s <sup>2</sup> K=1,5 m/s <sup>2</sup>	1,2421 m/s <sup>2</sup> K=1,5 m/s <sup>2</sup>	1,067 m/s <sup>2</sup> K=1,5 m/s <sup>2</sup>
Work time (Running time may vary, depending on conditions)	28 mins (with 2.0 Ah)	65 mins (with 2.0 Ah)	18 mins (with 2.0 Ah High mode)
	50 mins (with 4.0 Ah)	130 mins (with 4.0 Ah)	31 mins (with 4.0 Ah High mode)

CORDLESS - LAWN TRIMMER	
Cutting diameter	380 mm
Cutting speed	5,800 rpm
Speed control	Variable
Line diameter	2.4 mm

CORDLESS - HEDGETRIMMER	
Max cutting width	22 mm diameter
Cutting speed	2,600 spm
Blade dimensions	61 cm / 1.8 mm Dual Action

CORDLESS - BLOWER	
Air speed	Low: 72 km/h 20 m/s High: 120 km/h 33 m/s TURBO: 148 km/h 41 m/s
Air speed control	Variable
Air volume	Low: 420 m <sup>3</sup> /h High: 650 m <sup>3</sup> /h TURBO: 810 m <sup>3</sup> /h
Turbine speed	21,000 rpm +/- 10%

\*Guaranteed sound power level (in accordance with 2,000/14/EC Directive) in dB(A).

\*\*Sound pressure level at operator's ear LPA (measured according to ISO 22868).

■ Sold separately. Model availability is dependant on country, do not hesitate to ask your local Honda dealer.



# Honda tiller benefits

## Honda engineering

Looking after your garden or land can be a labour of love, but we don't believe it has to be labour intensive. Ever since our Honda 4-stroke tillers were introduced in 1967, they have been making light work of flowerbeds, vegetable patches and allotments around the world and are trusted by gardeners, commercial growers and contractors alike. They are all part of a highly efficient and user friendly tiller range designed to suit any requirement.

## 4-stroke technology

The Honda tiller range is powered by our ultra reliable 4-stroke engines, which are not only environmentally friendly with lower emissions, but are neighbourhood friendly, thanks to their low engine noise. They also save time and money, offering low fuel consumption and high torque even at low rpm, making sure you can drive through even the toughest earth. Our decompression mechanism ensures they start and restart easily, time and time again.





## Keeping you in control

Because soil can vary in consistency from garden to garden and every task demands high levels of flexibility, we have created a number of technologies to make work as effortless as possible, keeping you in control. For example, our tiller range features models with up to 6 forward gears enabling you to work at whatever speed the conditions require. Models with adjustable working width allow you to adapt the tiller to the specifics of your garden, whilst our Honda clutch control gives you precise direction control where and when you need it.



## Intuitive design

Our considerable experience in this sector has enabled us to design tillers that are easy, intuitive and a pleasure to use. They include features such as ergonomic controls and adjustable handles, that not only enable you to find your perfect working position, but on our Micro, Mini and Compact ranges, they fold for easier transport and storage.



## Multi-function capability

We offer a full range of attachments to make any Honda tiller, from our FG110 Micro to our impressive professional F720, a truly multi-function machine. You can add a lawn de-thatcher, aerator, scarifier, ridger, plough or potato lifter to your tiller, all of which have been specifically designed and built to perfectly compliment your Honda and give you the very best performance.



Transport Wheel



Foldable Handle



Side Discs\*



Swing Handle\*\*



\*Available on FG205 and F220 models only.  
\*\*Available on F220 model only.



### FG110 and FG201 outstanding micro tillers

The FG110 and FG201 are easy to use and transport, thanks to their lightweight design, intuitive controls and central carry handle. The main handlebar can also be folded down to maximise storage space.

For precise and accurate work, the tilling width of the FG201 can be adjusted between 16 and 30 cm.

Each machine comes with a set of 4 tines and a full range of optional attachments like border edger, lawn de-thatcher and aerator, so they enable you to complete different tasks.

### FG205 and F220 high performance mini tillers

Designed for lighter garden tasks, the Honda mini tillers come with a range of specialist tools as standard, from

crop protection side discs to safeguard delicate plants, to a unique Honda tine that digs and cultivates at the same time. They are practical and easy to use, with a low centre of gravity that ensures the machines are well balanced and manoeuvrable, whilst their foldable handles make transportation and storage simple.

	MICRO SPECIFICATION		MINI SPECIFICATION	
	FG110	FG201	FG205	F220
Weight	13.0 kg	17.0 kg	21.0 kg	30.0 kg
Forward tool rotation speed	182 rpm	197 rpm	135 rpm	130 rpm
Working width	23 cm	16 to 30 cm	25 to 45 cm	61.5 cm
Comes with	Set of 4 tines	Set of 4 tines	Set of 4 tines Side discs	Set of 4 tines Side discs
Attachment available	Lawn de-thatcher, aerator and border edger	Lawn de-thatcher, aerator and border edger	Lawn de-thatcher	Ridger and steel wheels



## Tiller micro and mini

### Small and tough

Our micro and mini tiller range is designed to be easily handled in smaller spaces and powerful enough to take care of flowerbeds, lawns and vegetable plots.



FG110



FG201



FG205



F220





\*FJ500 DE/DER model only.  
 \*\*FJ500 DE/DER & FJ500 SE/SER models only.  
 \*\*\*FJ500 DE/DER, F506, F510, F560 and F720 models only.  
 \*\*\*\*F560 & F720 models only.



### FG320 and FJ500 compact tiller range

Our compact tillers are light enough to be highly manoeuvrable, but heavy duty enough to cut out crucial time and effort on harder gardening tasks. Thanks to a powerful Honda engine and a manual gearbox, you can optimise speed and power for ease of use. The FJ500 is available in a choice of configurations, either with 1 forward and 1 reverse gear, or 2 forward and 1 reverse gear with a

swing handle feature. Both models can be fitted with a long list of attachments including multiple tine, scarifier, ridger, potato lifter, plough or snow blade.

### F506, F560 and F720 powerful and versatile range

A powerful and flexible range of tillers that are fitted with up to 6 forward and 2 reverse gears, transferring the ideal amount of torque and allowing you to pick the perfect rotation speed to match your pace

and earth conditions. All our versatile tillers come with a Power Take Off (PTO) shaft which can be used with specialist equipment for hulling, spraying, rear-rotary box tines etc. In order to make sure you are comfortable whilst working, the handle can be adjusted for height and width. The F560 and F720 are also fitted with a side clutch control, allowing you to accurately and precisely control your machine positioning.

	COMPACT SPECIFICATION			VERSATILE SPECIFICATION			
	FG320	FJ500 SE/SER	FJ500 DE/DER	F506	F510	F560	F720
Engine	GP160 - 163 cm <sup>3</sup>	GX160 - 163 cm <sup>3</sup>	GX160 - 163 cm <sup>3</sup>	GX160 - 163 cm <sup>3</sup>	GX160 - 163 cm <sup>3</sup>	GX160 - 163 cm <sup>3</sup>	GX200 - 196 cm <sup>3</sup>
Gearbox	1 forward + 1 reverse gear	1 forward + 1 reverse gear	2 forward + 1 reverse gear	3 forward + 1 reverse gear	6 forward + 2 reverse gear	6 forward + 2 reverse gear	6 forward + 2 reverse gear
Comes with	Side discs Set of tines	Side discs Set of tines (SER)	Side discs Transport wheel Set of tines (DER)	PTO (Power Take Off)	PTO (Power Take Off)	PTO Clutch control	PTO Clutch control



**Tiller** compact and versatile

## Smooth power and versatility

Our compact and versatile tiller range is powerful enough to tackle larger flowerbeds and vegetable patches. They are versatile too, with a wide selection of attachments designed for multiple tasks, soil types and desired finishes.



FJ500 DER



F720



## Tiller counter-rotating

# Ultimate tilling power

The FF300/500/750 feature our unique counter rotating tines that are powerful enough to cut through the most compacted soil with ease. Ideal for any dedicated gardener or commercial user.



FF300



FF500



FR750





**Performance**

Tough, reliable and powerful, these tillers have been designed to be easy to use and manoeuvre, with a low centre of gravity and a zero turn capability. They are controlled by an ergonomic loop handlebar which allows the user to find a grip position that suits them, whilst still maintaining complete clutch control.

The FF300/500 models both have height selectable front wheels that can be adjusted to 5 different positions to specify a desired tilling depth. They are also comfortable to work with, thanks to the counter rotating tines which reduce bucking.

**FR750: The ultimate tiller**

With a 600 mm tine width, 2 forward gears, 1 reverse and a deadman's clutch, the FR750 is built to make working safer and a lot easier. It also features our revolutionary Active Rotary System, a coaxial counter-rotating tine drive that dramatically improves stability, allowing smooth, easy operation.



Counter-rotating tines

COUNTER-ROTATING SPECIFICATION			
	FF300	FF500	FR750
Engine	GXV57 - 57 cm <sup>3</sup>	GX160 - 163 cm <sup>3</sup>	GX200 - 196 cm <sup>3</sup>
Forward tool rotation speed	131 rpm	141 rpm	238 rpm
Working width	29 to 45 cm	36 to 55 cm	51 cm



# Tiller specification

Use our handy table to compare our tiller models to choose the right one for you.

	MICRO		MINI		COMPACT	
	FG110	FG201	FG205	F220	FG320	FJ500 SE/SER
Engine	4-stroke OHC	4-stroke OHV	4-stroke OHV	4-stroke OHV	4-stroke OHV	4-stroke OHV
Engine model	GX25T	GXV50	GXV50	GXV57	GP160	GX160
Engine displacement (cc)	25.0	49.0	49.0	57.3	163.0	163.0
Engine net power kW/rpm	0.61/6,000	1.3/4,800	1.3/4,800	1.5/4,800	3.4/3,600	3.4/3,600
Engine net torque Nm/rpm	-	-	-	-	10.3/2,500	10.3/2,500
Fuel tank capacity (litres)	0.57	0.35	0.35	0.67	2.40	2.40
Engine oil capacity (litres)	0.08	0.30	0.30	0.30	0.58	0.58
Starter	Recoil	Recoil	Recoil	Recoil	Recoil	Recoil
Drive clutch	Automatic - centrifugal	Automatic - centrifugal	Automatic - centrifugal	Manual - expanding shoe	Manual - belt tension	Manual - belt tension
Transmission	Worm gear	Worm gear	Worm gear	Epicyclic gearing	Constant mesh	Constant mesh
Final transmission	-	-	-	Pinion and bevel gear	Chain	Chain
Differential/side clutch	-	-	-	-	-	-
Max tilling width (mm)	230	300	450	545	800	800
Max tilling depth (mm)	203	230	260	280	325	325
Forward speeds	1	1	1	1	1	1
Reverse speeds	-	-	-	-	1	1
Forward tool rotation speed (rpm or m/s)	182 rpm	197 rpm	135 rpm	130 rpm	108 rpm	113 rpm
Reverse tool rotation speed (rpm or m/s)	-	-	-	-	53 rpm	28 rpm
PTO rotation speed (low/high (rpm))	-	-	-	-	-	-
Rotors/tines supplied	4 x 6 tooth hoeing tines	4 x 4 tooth shredder tines	4 x 4 tooth digging tines	4 x 4 tooth digging tines	6 x 4 tooth digging tines	Multiple rotor options
Counter-rotating tines	-	-	-	-	-	-
Wheels	Rear transport	Rear transport	Rear transport	Front transport	Front transport	-
Side discs	-	-	•	•	•	•
Border edger	◦	◦	-	-	-	-
De-thatcher	◦	◦	◦	◦	-	◦
Aerator	◦	◦	-	-	-	-
Aerator/scarifier	-	-	-	◦	-	◦
Ridger	-	-	-	◦	-	◦
Foldable handle	•	•	•	•	-	•
Height adjustable handle	-	-	-	•	•	•
Swing handle	-	-	-	•	•	-
Dimensions (L x W x H (mm))	1,175 x 365 x 958	1,185 x 455 x 980	1,155 x 510 x 1,035	1,280 x 615 x 1,035	1,500 x 837 x 980	1,395 x 610 x 980
Dry weight (kg)	13.0*	17.0	21.0	30.0	53.0	45.0/57.0
Sound pressure at operators ears dB(A) <sup>◊</sup>	70.5	79.0	79.5	75.0	84.0	81.0
Guaranteed sound power level dB(A) <sup>◊</sup>	93	93	93	92	-	96
Vibration (m/sec <sup>2</sup> ) <sup>Δ</sup>	9.2	5.0	12.5	6.4	7.0	5.6

Standard • Optional ◦ Not available -





COMPACT			VERSATILE		COUNTER-ROTATING		
FJ500 DE/DER	F506	F510	F560	F720	FF300	FF500	FR750
4-stroke OHV	4-stroke OHV	4-stroke OHV	4-stroke OHV	4-stroke OHV	4-stroke OHV	4-stroke OHC	4-stroke OHV
GX160	GX160	GX160	GX160	GX200	GXV57	GCV160	GX200
163.0	163.0	163.0	163.0	196.0	57.0	160.0	196.0
3.6/3,600	3.6/3,600	3.6/3,600	3.6/3,600	4.1/3,600	1.5/4,800	3.3/3,600	4.1/3,600
10.3/2,500	10.3/2,500	10.3/2,500	10.3/2,500	-	-	-	-
2.40	2.60	2.30	2.20	2.10	0.78	1.70	2.50
0.58	0.60	0.60	0.60	0.60	0.30	0,55	0.60
Recoil	Recoil	Recoil	Recoil	Recoil	Recoil	Recoil	Recoil
Manual - belt tension	Manual - belt tension	Manual - belt tension	Manual - belt tension	Manual - belt tension	Manual - expanding shoe	Manual - expanding shoe	Manual - belt tension
Constant mesh	Constant mesh	Constant mesh	Constant mesh	Constant mesh	Wheels - epicyclic gearing to bevel gear	Wheels - epicyclic gearing to bevel gear	Variable sliding
Chain	Chain	Chain	Chain	Chain	Wheels - constant mesh/Tines - chain and gear	Wheels - constant mesh/Tines - chain and gear	Tines - chain
-	-	-	•	•	•	•	•
800	900	900	900	900	410	550	510
325	330	330	330	360	160	200	326
2	3	6	6	6	3	3	2
1	1	2	2	2	1	1	1
80 - 113 rpm	52 - 122 rpm	21 - 122 rpm	16 - 122 rpm	11 - 116 rpm	0.15 - 1 m/s	0.20 - 1 m/s	0.35 - 1.22 m/s
28 rpm	50 rpm	16 - 32 rpm	16 - 32 rpm	14 - 23 rpm	0.30 m/s	0.30 m/s	0.36 m/s
-	-	-	867/1,739	896/1,461	131	141	238
Multiple rotor options	Multiple rotor options	Multiple rotor options	Multiple rotor options	Multiple rotor options	Front counter rotation digging tines	Front counter rotation digging tines	Rear rotary tines
-	-	-	-	-	•	•	•
Front transport	Optional wheels & tyres	Optional wheels & tyres	Optional wheels & tyres	Optional wheels & tyres	Wheels & tyres	Wheels & tyres	Wheels & tyres
•	◦	◦	◦	◦	-	-	-
-	-	-	-	-	-	-	-
◦	◦	◦	◦	-	-	-	-
-	-	-	-	-	-	-	-
◦	◦	◦	◦	-	-	-	-
◦	◦	◦	◦	◦	◦	◦	-
•	-	-	-	-	-	-	-
•	•	•	•	•	•	•	•
•	•	•	•	•	-	-	-
1,395 x 610 x 980	1,585 x 610 x 865	1,585 x 610 x 865	1,610 x 610 x 990	1,630 x 660 x 1,095	1,465 x 465 x 1,010	1,730 x 585 x 1,045	1,500 x 570 x 1,140
49.0/62.0	47.0	50.0	53.0	72.0/75.0	50.5	77.0	91.0
81.0	80.0	83.0	81.0	79.0	74.0	79.0	79.0
96	97	97	97	97	92	93	97
5.6	6.0	6.0	13.2	6.2	4.5	4.8	3.5

\*Weight with attachments.

<sup>§</sup>Sound pressure (as per directives EN 709: 1997+A4 in dB(A)).

<sup>¶</sup>Guaranteed sound power level (as per directives 2000/14/EC, 2005/88/EC in dB(A)).

<sup>^</sup>Guaranteed vibration (as per directives EN 709: 1997+A4 in dB(A)).

Standard • Optional ◦ Not available -

Model availability is dependant on country, do not hesitate to ask your local Honda dealer.







# Power you rely on

Quiet, dependable and always ready to help, our comprehensive range of generators is trusted around the world. From equatorial jungles to research posts in the Arctic Circle, they provide versatile, powerful and reliable performance at a moment's notice. If you're looking for a backup power supply for your home or need assistance with outdoor activities, contact your local dealer and discover what our generators can do for you.



## HONDA GENERATORS AND WATER PUMPS





# World of Honda Power Equipment

For years, we've built our Power Equipment range around our clean Honda 4-stroke engine technology. That's because we're committed to making our products as user-friendly, fuel-efficient and reliable as we can - all without compromising performance. Class-leading 4-stroke principles still drive many of our products, but we're always pushing.





# HONDA

## AUTHORISED DEALER

### SALES SERVICE EXPERTISE

You deserve complete confidence that you've made the right choice, long after you've made the purchase. That's why we appoint our Honda Authorised Dealers with as much care as we build into our products.

Look for the seal of quality when you buy your Honda, or call **0845 200 8000\*\*** and we'll find the closest to you.



### Sales

Our Authorised Dealers not only feature a comprehensive display of Honda products to see and touch, but they know our product range inside-out. Every one follows an extensive Honda training programme with regular refresher courses – so you can trust in their valuable advice and experience to help you choose the product that's just right for you and your needs.



### Service

As well as offering the highest levels of after-sales service, our Authorised Dealers' factory-trained technicians perform a full Pre-Delivery Inspection (PDI) on every machine, and are fully equipped to keep your product in peak condition with cost-effective servicing. Of course, you can also be assured that only high quality, genuine Honda parts are used, with access to our 24hr parts delivery service for fast and efficient turnaround.



### Expertise

Our Authorised Dealers are true experts in their field, often with years of first-hand experience under their belt. In fact, their knowledge and experience plays an important role in making sure that our Research and Development team is given feedback from our customers, so we can ensure that new and improved models continue to meet your future needs too.

## Unrivalled quality, for peace of mind

There's a simple reason why you'll see so many old Honda products still in use. **Ours are built better, to last longer.**

That's not just an idle promise. It's fact. Our enviable reputation for durability and reliability is supported by our cast iron warranty, covering both parts and labour.

Our warranty maintains the same value throughout its lifetime too – meaning the last day of cover is exactly the same as the first: solid and dependable.

Core Range



Domestic Use

Izy Handheld Tiller Riding Mower



Domestic Use

Robotic Mower Electric Range



Domestic Use

Garden Range\*\*\*

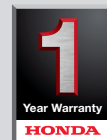

Commercial Use





## **Honda (UK)**

Cain Road, Bracknell, Berkshire, RG12 1HL  
United Kingdom  
Honda Contract Centre 0845 200 8000  
[www.honda.co.uk](http://www.honda.co.uk)

These specification details do not apply to any particular product which is supplied or offered for sale. The manufacturer reserves the right to vary their specification, including colours, with or without notice at such times in such manner as they think fit. Major as well as minor changes may be involved. Every effort, however, is made to ensure the accuracy of the particulars contained in this brochure. Consult the Dealer with whom your order is placed for details of the specification of any particular product. This publication shall not constitute in any circumstances whatsoever an offer by the Company to any person. All sales are made by the Distributor or Dealer concerned subject to and with the benefit of the standard Conditions of Sale and Warranty given by the Distributor. While efforts are made to ensure specification accuracy, brochures are prepared and printed several months in advance of distribution and consequently cannot always immediately reflect either changes in specification or in some isolated cases the provision of a particular feature. Customers are always advised to discuss specific details with the supplying Dealer, especially if a selection is dependent upon one of the features advertised.