

AFRICA TWIN

AFRICA TWIN

OWNER'S MANUAL

EN



This manual should be considered a permanent part of the vehicle and should remain with the vehicle when it is resold.

This publication includes the latest production information available before printing. Honda Motor Co., Ltd. reserves the right to make changes at any time without notice and without incurring any obligation.

No part of this publication may be reproduced without written permission.

The vehicle pictured in this owner's manual may not match your actual vehicle.

# Welcome

Congratulations on your purchase of a new Honda vehicle. Your selection of a Honda makes you part of a worldwide family of satisfied customers who appreciate Honda's reputation for building quality into every product.

To ensure your safety and riding pleasure:

- Read this owner's manual carefully.
- Follow all recommendations and procedures contained in this manual.
- Pay close attention to safety messages contained in this manual and on the vehicle.

- The following codes in this manual indicate each country.
- The illustrations here in are based on the CRF1100D4 II ED type.

### Country Codes

Code	Country
<b>CRF1100A</b>	
ED, II ED	European direct sales, France, South Africa, Turkey
<b>CRF1100A2</b>	
ED, II ED	European direct sales, France, South Africa, Turkey
<b>CRF1100A4</b>	
ED, II ED	European direct sales, France, South Africa, Turkey

### CRF1100D

ED, II ED	European direct sales, France, South Africa, Turkey
-----------	---

### CRF1100D2

ED, II ED	European direct sales, France, South Africa, Turkey
-----------	---

### CRF1100D4

ED, II ED	European direct sales, France, South Africa, Turkey
-----------	---

\*The specifications may vary with each locale.

## A Few Words About Safety

Your safety, and the safety of others, is very important. Operating this vehicle safely is an important responsibility.

To help you make informed decisions about safety, we have provided operating procedures and other information on safety labels and in this manual. This information alerts you to potential hazards that could hurt you or others.

Of course, it is not practical or possible to warn you about all hazards associated with operating or maintaining a vehicle. You must use your own good judgement.

You will find important safety information in a variety of forms, including:

- Safety labels on the vehicle
- Safety Messages preceded by a safety alert symbol  and one of three signal words: DANGER, WARNING, or CAUTION.

These signal words mean:

### **DANGER**

You **WILL** be **KILLED** or **SERIOUSLY HURT** if you don't follow instructions.

### **WARNING**

You **CAN** be **KILLED** or **SERIOUSLY HURT** if you don't follow instructions.

### **CAUTION**

You **CAN** be **HURT** if you don't follow instructions.

### **Other important information is provided under the following titles:**

**NOTICE** Information to help you avoid damage to your vehicle, other property, or the environment.



# Contents

**Vehicle Safety** P. 2

**Operation Guide** P. 20

**Maintenance** P. 232

**Troubleshooting** P. 298

**Information** P. 339

**Specifications** P. 359

**Index** P. 365

# Vehicle Safety

This section contains important information for safe riding of your vehicle.  
Please read this section carefully.

<b>Safety Guidelines</b> .....	P. 3
<b>Image Labels</b> .....	P. 7
<b>Safety Precautions</b> .....	P. 12
<b>Riding Precautions</b> .....	P. 13
<b>Accessories &amp; Modifications</b> .....	P. 17
<b>Off-Road Safety</b> .....	P. 18
<b>Loading</b> .....	P. 19



## Safety Guidelines

Follow these guidelines to enhance your safety:

- Perform all routine and regular inspections specified in this manual.
- Stop the engine and keep sparks and flame away before filling the fuel tank.
- Do not run the engine in enclosed or partly enclosed areas. Carbon monoxide in exhaust gases is toxic and can kill you.

### Always Wear a Helmet

It's a proven fact: helmets and protective apparel significantly reduce the number and severity of head and other injuries. So always wear an approved helmet and protective apparel. 📖 P. 12

### Before Riding

Make sure that you are physically fit, mentally focused and free of alcohol and drugs. Check that you and your passenger are both wearing an approved helmet and protective apparel. Instruct your passenger on holding onto the grab rail or your waist, leaning with you in turns, and keeping their feet on the footpegs, even when the vehicle is stopped.

### Take Time to Learn & Practice

Even if you have ridden other vehicles, practice riding in a safe area to become familiar with how this vehicle works and handles, and to become accustomed to the vehicle's size and weight.

### Ride Defensively

Always pay attention to other vehicles around you, and do not assume that other drivers see you. Be prepared to stop quickly or perform an evasive maneuver.

### **Make Yourself Easy to See**

Make yourself more visible, especially at night, by wearing bright reflective clothing, positioning yourself so other drivers can see you, signaling before turning or changing lanes, and using your horn when necessary.

### **Be Alert for Off-road Hazards**

The terrain can be present a variety of challenges when you ride off-road. Continually “read” the terrain for unexpected turns, drop-offs, rocks, ruts and other hazards. Always keep your speed low enough to allow time to see and react to hazards.

### **Ride within Your Limits**

Never ride beyond your personal abilities or faster than conditions warrant. Fatigue and inattention can impair your ability to use good judgement and ride safely.

### **Don't Drink and Ride**

Alcohol and riding don't mix. Even one alcoholic drink can reduce your ability to respond to changing conditions, and your reaction time gets worse with every additional drink. Don't drink and ride, and don't let your friends drink and ride either.

### **Keep Your Honda in Safe Condition**

It's important to keep your vehicle properly maintained and in safe riding condition. Having a breakdown can be difficult, especially if you are stranded off-road far from your base. Inspect your vehicle before every ride and perform all recommended maintenance. Never exceed load limits (➤ P. 19), and do not modify your vehicle or install accessories that would make your vehicle unsafe (➤ P. 17).

### If You are Involved in a Crash

Personal safety is your first priority. If you or anyone else has been injured, take time to assess the severity of the injuries and whether it is safe to continue riding. Call for emergency assistance if needed. Also follow applicable laws and regulations if another person or vehicle is involved in the crash.

If you decide to continue riding, first turn the ignition switch to the  (Off) position, and evaluate the condition of your vehicle. Inspect for fluid leaks, check the tightness of critical nuts and bolts, and check the handlebar, control levers, brakes, and wheels. Ride slowly and cautiously.

Your vehicle may have suffered damage that is not immediately apparent. Have your vehicle thoroughly checked at a qualified service facility as soon as possible.

### Lithium-Ion (Li-Ion) Battery

If you smell an unusual odor coming from the lithium-ion (li-ion) battery, park your vehicle in a safe place outside and away from flammable objects, then turn the ignition switch to the  (Off) position. Have your vehicle inspected by your dealer immediately.

### Carbon Monoxide Hazard

Exhaust contains poisonous carbon monoxide, a colourless, odorless gas. Breathing carbon monoxide can cause loss of consciousness and may lead to death.

If you run the engine in confined or even partly enclosed area, the air you breathe could contain a dangerous amount of carbon monoxide.

Never run your vehicle inside a garage or other enclosure.

### **WARNING**

Running the engine of your vehicle while in an enclosed or even partially enclosed area can cause a rapid build-up of toxic carbon monoxide gas.

Breathing this colourless, odorless gas can quickly cause unconsciousness and lead to death.

Only run your vehicle's engine when it is located in a well ventilated area outdoors.

## Image Labels

The following pages describe the label meanings. Some labels warn you of potential hazards that could cause serious injury. Others provide important safety information. Read this information carefully and don't remove the labels.

If a label comes off or becomes hard to read, contact your dealer for a replacement.

There is a specific symbol on each label. The meanings of each symbol and label are as follows.



Read instructions contained in Owner's Manual carefully.



Read instructions contained in Shop Manual carefully. In the interest of safety, take the vehicle to be serviced only by your dealer.



**DANGER (with RED background)**

You **WILL** be **KILLED** or **SERIOUSLY HURT** if you don't follow instructions.

**WARNING (with ORANGE background)**

You **CAN** be **KILLED** or **SERIOUSLY HURT** if you don't follow instructions.

**CAUTION (with YELLOW background)**

You **CAN** be **HURT** if you don't follow instructions.

**BATTERY LABEL****DANGER**

- Do not dismantle, modify or solder the main unit and battery terminals. Doing so may cause leakage, heat generation, explosion, fire or loss of vision due to leaked electrolyte.  
If electrolyte gets into one's eye, immediately wash the eye with plenty of water, and receive treatment from an eye specialist (ophthalmologist) as soon as possible.
- Keep this product away from fires and high temperature heat sources. Do not bring or cause fires (matches, lighters, cigarettes, sparks at terminals or from welding machines or grinders) close to the battery. Doing so may cause heat generation, explosion or fire.
- Carefully read this manual.  
If this product is handled incorrectly, it may lead to damage to the vehicle, heat generation, explosion, fire, loss of vision or burns.

**RADIATOR CAP LABEL****DANGER**

NEVER OPEN WHEN HOT.

Hot coolant will scald you.

Relief pressure valve begins to open at **1.1 kgf/cm<sup>2</sup>**.

## ACCESSORIES AND LOADING WARNING LABEL

### ACCESSORIES AND LOADING

#### CRF1100A/D



#### CRF1100A2/A4/D2/D4



- The safety stability and handling of this vehicle may be affected by the addition of accessories and luggage.
- Read carefully the instructions contained in user's manual and installation guide before installing any accessory.
- **CRF1100A/D**

The total weight of accessories and luggage added to rider's and passenger's weight should not exceed **220 kg (485 lb)**, which is the maximum weight capacity.

#### **CRF1100A2/A4/D2/D4**

The total weight of accessories and luggage added to rider's and passenger's weight should not exceed **218 kg (481 lb)**, which is the maximum weight capacity.

- The luggage weight must not exceed **29 kg (64 lb)** under any circumstances.
- The fitting of large fork-mounted or large handlebar mounted fairing is not recommended.



**REAR CUSHION LABEL**

GAS FILLED

Do not open. Do not heat.



**TYRE LABEL**

**WARNING**

If M+S tyres are installed, keep maximum speed to less than **160 km/h (99 mph)**.



**TYRE INFORMATION & DRIVE CHAIN LABEL**

Cold tyre pressure:

[Driver only]

Front **225 kPa (2.25 kgf/cm<sup>2</sup>, 33 psi)**Rear **250 kPa (2.50 kgf/cm<sup>2</sup>, 36 psi)**

[Driver and passenger]

Front **225 kPa (2.25 kgf/cm<sup>2</sup>, 33 psi)**Rear **280 kPa (2.80 kgf/cm<sup>2</sup>, 41 psi)**

Keep chain adjusted and lubricated.

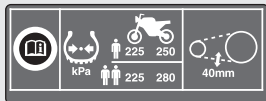
Freeplay **35 - 45 mm (1.4 - 1.8 in)****SAFETY REMINDER LABEL**

For your protection, always wear helmet, protective apparel.

**FUEL LABEL**

Unleaded petrol only

ETHANOL up to 10 % by volume

**REAR CARRIER LABEL****CRF1100A2/A4/D2/D4**Do not exceed **10 kg (22 lb)**.

# Safety Precautions

- Ride cautiously and keep your hands on the handlebar and feet on the footpegs.
- Keep passenger's hands onto the grab rail or your waist, passenger's feet on the footpegs while riding.
- Always consider the safety of your passenger, as well as other drivers and riders.

## Protective Apparel

Make sure that you and any passenger are wearing an approved helmet, eye protection, and high-visibility protective clothing. Ride defensively in response to weather and road conditions.

### ■ Helmet

Safety-standard certified, high-visibility, correct size for your head

- Must fit comfortably but securely, with the chin strap fastened.

- Face shield with unobstructed field of vision or other approved eye protection

## WARNING

Not wearing a helmet increases the chance of serious injury or death in a crash.

Make sure that you and any passenger always wear an approved helmet and protective apparel.

### ■ Gloves

Full-finger leather gloves with high abrasion resistance

### ■ Boots or Riding Shoes

Sturdy boots with non-slip soles and ankle protection

## ■ Jacket and Trousers

Protective, highly visible, long-sleeved jacket and durable trousers for riding (or a protective suit)

## ■ Additional Off-road Gear

On-road apparel may also be suitable for casual off-road riding. But if you plan on any serious off-road riding you will need more serious off-road gear. In addition to your helmet and eye protection, we recommend off-road motorcycle boots and gloves, riding pants with knee and hip pads, a jersey with elbow pads, and a chest/shoulder protector.

# Riding Precautions

## Running-in Period

During the first 500 km (300 miles) of running, follow these guidelines to ensure your vehicle's future reliability and performance.

- Avoid full-throttle starts and rapid acceleration.
- Avoid hard braking and rapid down-shifts.
- Ride conservatively.

## Brakes

Observe the following guidelines:

- Avoid excessively hard braking and downshifting.
  - ▶ Sudden braking can reduce the vehicle's stability.
  - ▶ Where possible, reduce speed before turning; otherwise you risk sliding out.

## Riding Precautions

- Exercise caution on low traction surfaces.
  - ▶ The tyres slip more easily on such surfaces and braking distances are longer.
- Avoid continuous braking.
  - ▶ Repeated braking, such as when descending long, steep slopes can seriously overheat the brakes, reducing their effectiveness. Use engine braking with intermittent use of the brakes to reduce speed.
- For full braking effectiveness, operate both the front and rear brakes together.

### ■ Anti-lock Brake System (ABS)

This model is equipped with an Anti-lock Brake System (ABS) designed to help prevent the brakes from locking up during hard braking. The ABS functions with information provided by the IMU (Inertia Measurement Unit).

- ABS does not reduce braking distance. In certain circumstances, ABS may result in a longer stopping distance.

- ABS does not function at speeds below 10 km/h (6 mph).
- The brake lever and pedal may recoil slightly when applying the brakes. This is normal.
- Always use the recommended front/rear tyres and sprockets to ensure correct ABS operation.

### ■ Engine Braking

Engine braking helps slow your vehicle down when you release the throttle. For further slowing action, downshift to a lower gear. Use engine braking with intermittent use of the brakes to reduce speed when descending long, steep slopes.

### ■ Wet or Rainy Conditions

Road surfaces are slippery when wet, and wet brakes further reduce braking efficiency. Exercise extra caution when braking in wet conditions.

If the brakes get wet, apply the brakes while riding at low speed to help them dry.

## Parking

- Park on a firm, level surface.
- If you must park on a slight incline or loose surface, park so that the vehicle cannot move or fall over.
- Make sure that high-temperature parts cannot come into contact with flammable materials.
- Do not touch the engine, muffler, brakes and other high-temperature parts until they cool down.
- To reduce the likelihood of theft, always lock the handlebar and remove the key when leaving the vehicle unattended. Use of an anti-theft device is also recommended.

## ■ Parking with the Side Stand

1. Stop the engine.
2. Push the side stand down.
3. Slowly lean the vehicle to the left until its weight rests on the side stand.

4. Turn the handlebar fully to the left.
  - ▶ Turning the handlebar to the right reduces stability and may cause the vehicle to fall.
5. Turn the ignition switch to the  (Lock) position and remove the key. ➤ P. 121

## Refuelling and Fuel Guidelines

Follow these guidelines to protect the engine, fuel system and catalytic converter:

- Use only unleaded petrol.
- Use recommended octane number. Using lower octane petrol will result in decreased engine performance.
- Do not use fuels containing a high concentration of alcohol. ➤ P. 353
- Do not use stale or contaminated petrol or an oil/petrol mixture.
- Avoid getting dirt or water in the fuel tank.

### **Honda selectable torque control**

When the Honda selectable torque control (Torque Control) detects rear wheel spin during acceleration, the system will limit the amount of torque applied to the rear wheel based on the Torque Control level selected.

Additionally, the system eases the rapid motion during the wheelie when accelerating based on the Torque Control level selected.

Torque Control will allow some wheel spin during acceleration at the lower Torque Control levels settings. Select a level that is appropriate for your skill and riding conditions.

Torque Control does not work during deceleration and will not prevent the rear wheel from skidding due to engine braking. Do not close the throttle suddenly, especially when riding on slippery surfaces.

Torque Control may not compensate for rough road conditions or rapid throttle operation.

Always consider road and weather conditions, as well as your skills and condition, when applying throttle.

If your vehicle gets stuck in mud, snow or sand, it may be easier to free it by turning off the Torque Control temporarily.

Temporarily turning off Torque Control also may help you maintain control and balance when riding on off-road terrain.

Always use the recommended tyres and sprockets to ensure correct Torque Control operation.

## Accessories & Modifications

We strongly advise that you do not add any accessories that were not specifically designed for your vehicle by Honda or make modifications to your vehicle from its original design. Doing so can make it unsafe. Modifying your vehicle may also void your warranty and make your vehicle illegal to operate on public roads. Before deciding to install accessories on your vehicle be certain the modification is safe and legal.

### **WARNING**

Improper accessories or modifications can cause a crash in which you can be seriously hurt or killed.

Follow all instructions in this owner's manual regarding accessories and modifications.

Do not pull a trailer with, or attach a sidecar to, your vehicle. Your vehicle was not designed for these attachments, and their use can seriously impair your vehicle's handling.

## Off-Road Safety

Learn to ride in an uncongested off-road area free of obstacles before venturing onto unfamiliar terrain.

- Always obey local off-road riding laws and regulations.
- Obtain permission to ride on private property. Avoid posted areas and obey "NO Trespassing" signs.
- Ride with a friend on another vehicle so that you can assist each other in case of trouble.
- Familiarity with your vehicle is critically important should a problem occur far from help.

- Never ride beyond your ability and experience or faster than conditions warrant.
- If you are not familiar with the terrain, ride cautiously. Hidden rocks, holes, or ravines could spell disaster.
- A muffler is required in most off-road areas. Don't modify your exhaust system. Remember that excessive noise bothers everyone and creates a bad image for motorcycling.



## Loading

- Carrying extra weight affects your vehicle's handling, braking and stability. Always ride at a safe speed for the load you are carrying.
- Avoid carrying an excessive load and keep within specified load limits.

**Maximum weight capacity / Maximum luggage weight** ➤ P. 359

- Tie all luggage securely, evenly balanced and close to the centre of the vehicle.
- Do not place objects near the lights or the muffler.

Also follow these guidelines when you ride off-road on rough terrain:

- Do not carry a passenger.
- Keep cargo small and light weight. Make sure it cannot easily be caught on brush or other objects, and that it does not interfere with your ability to shift position to maintain balance and stability.

### **WARNING**

Overloading or improper loading can cause a crash and you can be seriously hurt or killed.

Follow all load limits and other loading guidelines in this manual.

# Parts Location

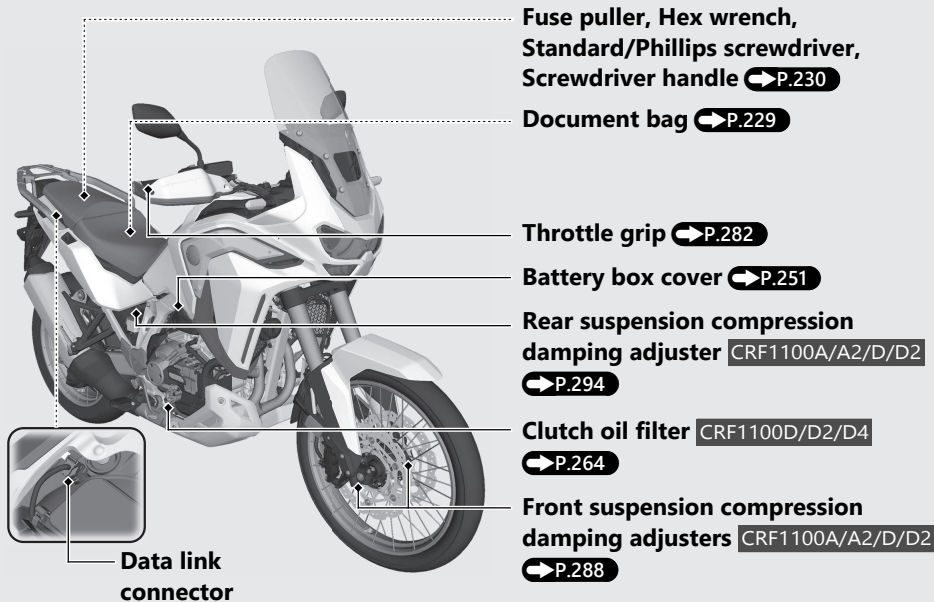

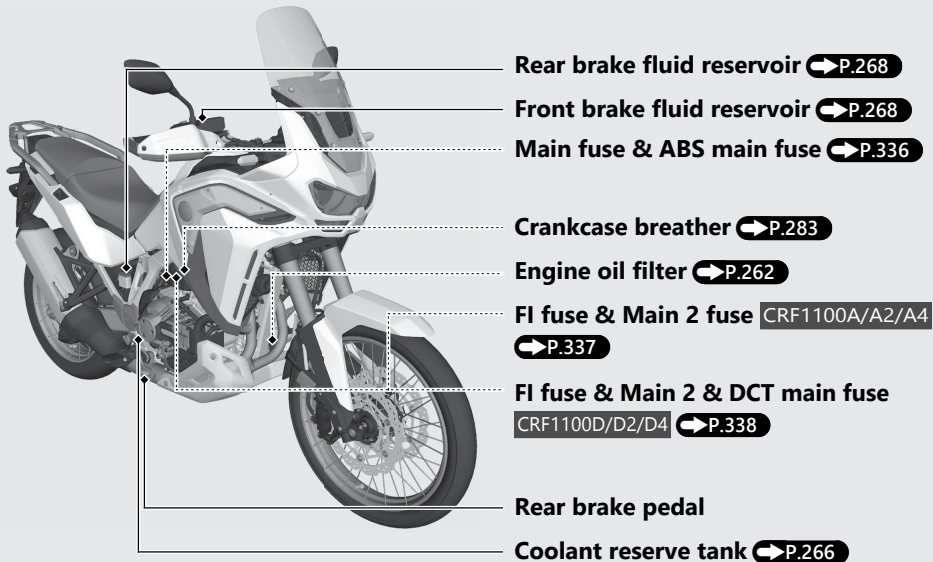

## Parts Location *(Continued)*

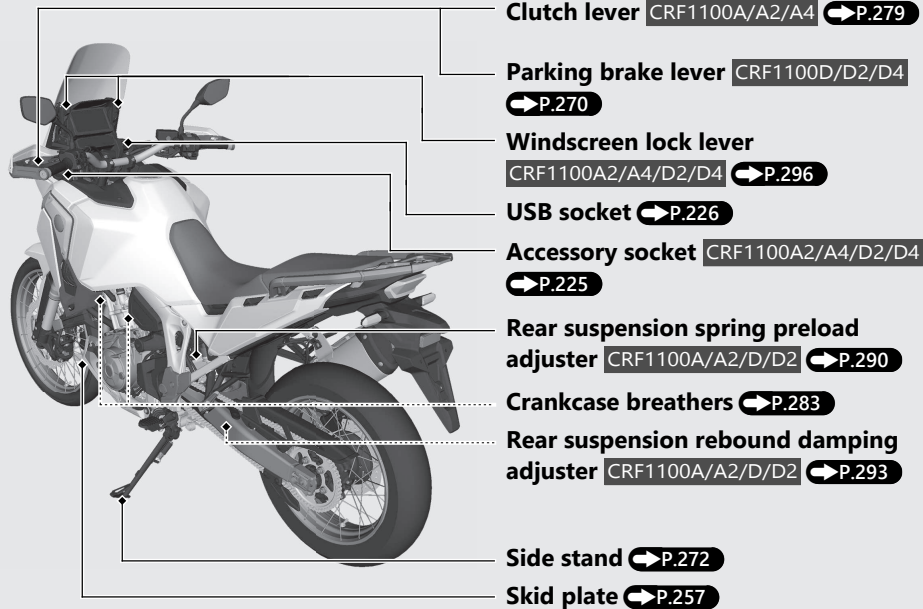

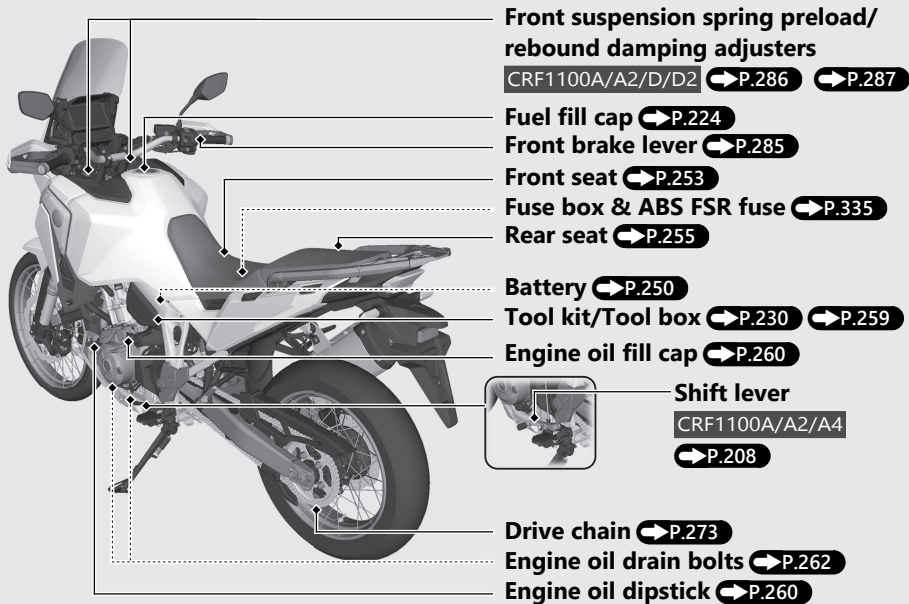

# Instruments

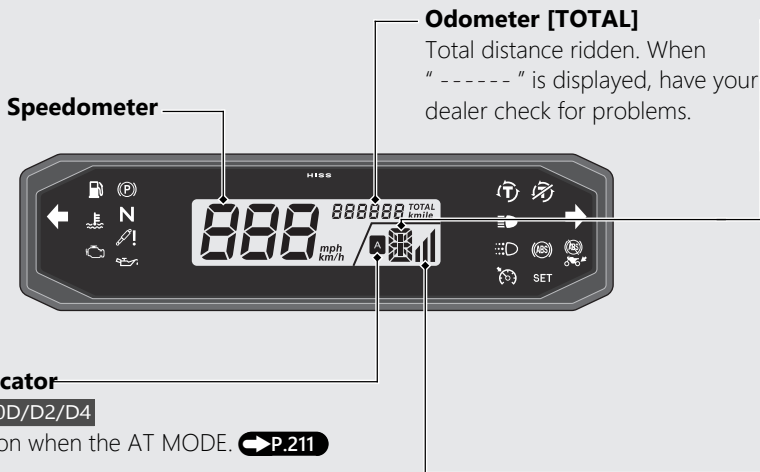

## Display Check

When the ignition switch is turned to the **I** (On) position, all the mode and digital segments will show. If any part of these displays does not come on when it should, have your dealer check for problems.

## Gear position indicator

### CRF1100A/A2/A4

The gear position is shown in the gear position indicator.



- ▶ "-" appears when the transmission is not shifted properly.

### CRF1100D/D2/D4

The gear position is shown in the gear position indicator when the MT MODE is selected.

The indicator may flash if:

- ▶ The front wheel leaves the ground.
- ▶ You turn the wheel while the vehicle is upright on the stand.

This is normal. To operate the system again, turn the ignition switch to the  (Off) position, and then to the  (On) position again.

D is shown in the gear position indicator when the D mode is selected in the AT MODE.

S is shown in the gear position indicator when the S mode is selected in the AT MODE.

**If the "-" indicator is blinking in the gear position window while riding:  P.305**

## S mode level indicator P.211

### CRF1100D/D2/D4

## Instruments *(Continued)*

### Multi-information display

Your vehicle is equipped with a multi-information display that presents various functions and settings.

The multi-information display is a screen. You can operate by touching the screen.

- Certain manual functions and settings are disabled or inoperable while the vehicle is in motion. You cannot select a greyed-out menu until the vehicle is stopped.

When the ignition switch is turned **I** (On), the Notice message appears on the screen for a few seconds.

Read the Notice message, and then press the **ENT** switch or touch [OK] on the screen.

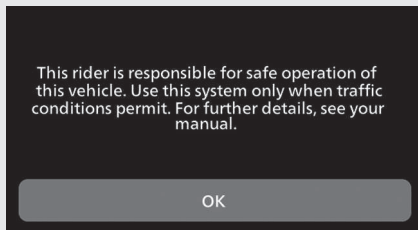



## Home Screen

From this screen, you can go to various functions and setup options.

**To return to the Home screen:** ➔ P.38

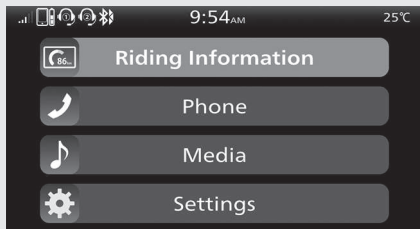

## Riding Information

You can go back to the riding information. Riding information has 3 displays, Gold image display, Silver image display and Bronze image display.

These displays are switched according to riding mode.

Gold image display ➔ P.28

Silver image display ➔ P.32

Bronze image display ➔ P.35

To change the display setting on each riding mode ➔ P.81

## Phone

You can make calls using a *Bluetooth*® connected *Bluetooth*® audio devices.

## Media

You can play music from *Bluetooth*® devices.

## Settings

You can select various settings.

## Instruments (Continued)

### Riding Information

#### Gold image display

#### Clock (12-hour or 24-hour display)

To set the clock: ➔ P.90

#### Riding mode display

➔ P.142

#### Side stand indicator

➔ P.66

#### Sub-information indicator

➔ P.41

#### Cruise Control Set Speed

The speed set for cruise control is displayed.

Cruise Control: ➔ P.215

#### Air temperature gauge

➔ P.66



#### Speedometer

## Tachometer

### NOTICE

Do not operate the engine in the Tachometer red zone.  
Excessive engine speed can adversely affect engine life.

## Tachometer red zone

(excessive engine rpm range)

## Fuel gauge

Remaining fuel when only E (1st) segment starts flashing:

Approximately 3.6 L (0.95 US gal, 0.79 Imp gal) (CRF1100A/D)

Approximately 3.9 L (1.03 US gal, 0.86 Imp gal) (CRF1100A2/A4/D2/D4)

**If the fuel gauge indicator flashes: ➔ P.306**

### NOTICE

You should refuel when the reading approaches the E (1st) segment.  
Running out of fuel can cause the engine to misfire, damaging the catalytic converter.



## Coolant temperature gauge

When the coolant is over specified temperature, all segments turn red and the H (6th) segment flashes and high coolant temperature indicator lamps. ➔ P.300

**If the coolant temperature gauge indicator flashes: ➔ P.307**



## Instruments (Continued)

### Torque Control level [T] indicator P.133

When the indicator flashes, have your dealer check for problems.

### [EB] [Engine Brake] level indicator P.142

When the indicator flashes, have your dealer check for problems.

### [P] [Power] level indicator P.142

When the indicator flashes, have your dealer check for problems.



### G switch [G] indicator P.126 CRF1100D/D2/D4

When the indicator flashes, have your dealer check for problems.

### ABS mode [ABS] indicator P.142

When the indicator flashes, have your dealer check for problems.

### [S] [Overall] indicator P.142 CRF1100A4/D4

When the indicator flashes, have your dealer check for problems.

## Handle grip heater status icon

CRF1100A2/A4/D2/D4

The handle grip heater status icon will appear while the handle grip heater is on.  **P.132**

**If the handle grip heater status icon flashes:**  **P.307**

## Gear position indicator



CRF1100A/A2/A4

The gear position is shown in the gear position indicator.  
 ▶ “-” appears when the transmission is not shifted properly.

CRF1100D/D2/D4

The gear position is shown in the gear position indicator.  
 The indicator may flash if:

- ▶ The front wheel leaves the ground.
- ▶ You turn the wheel while the vehicle is upright on the stand.

This is normal. To operate the system again, turn the ignition switch to the  (Off) position, and then to the  (On) position again.

D is shown in the gear position indicator when the D mode is selected in the AT MODE.

S is shown in the gear position indicator when the S mode is selected in the AT MODE.

 **S mode level indicator**  **P.211**

**If the “-” indicator is blinking in the gear position window while riding:**  **P.305**

## Instruments *(Continued)*

### Silver image display

Side stand indicator

➔ P.66

Riding mode display

➔ P.142

Clock (12-hour or 24-hour display)

To set the clock: ➔ P.90

#### NOTICE

You should refuel when the reading approaches the E (1st) segment. Running out of fuel can cause the engine to misfire, damaging the catalytic converter.



**Fuel gauge**

Remaining fuel when only E (1st) segment starts flashing:

Approximately 3.6 L (0.95 US gal, 0.79 Imp gal) (CRF1100A/D)

Approximately 3.9 L (1.03 US gal, 0.86 Imp gal) (CRF1100A2/A4/D2/D4)

**If the fuel gauge indicator flashes: ➔ P.306**

## **Handle grip heater status icon**

CRF1100A2/A4/D2/D4

The handle grip heater status icon will appear while the handle grip heater is on.

 **P.132**

**If the handle grip heater status icon flashes:**  **P.307**

**Air temperature gauge**  **P.66**

## **Tachometer**

### **NOTICE**

Do not operate the engine in the Tachometer red zone.  
Excessive engine speed can adversely affect engine life.

## **Tachometer red zone**

(excessive engine rpm range)

## **Speedometer**

## **Cruise Control Set Speed**

The speed set for cruise control is displayed.

**Cruise Control:**  **P.215**

## Instruments *(Continued)*

### Torque Control level [T] indicator P.133

When the indicator flashes, have your dealer check for problems.

### [EB] [Engine Brake] level indicator P.142

When the indicator flashes, have your dealer check for problems.

### [P] [Power] level indicator P.142

When the indicator flashes, have your dealer check for problems.

### Sub-information indicator P.41

### ABS mode [ABS] indicator

 P.142

When the indicator flashes, have your dealer check for problems.



### [S] [Overall] indicator P.142

CRF1100A4/D4

When the indicator flashes, have your dealer check for problems.



## Bronze image display

**Clock (12-hour or 24-hour display)**

To set the clock: ➔ P.90

**Riding mode display**

➔ P.142

**Side stand indicator**

➔ P.66



**Cruise Control Set Speed**

The speed set for cruise control is displayed.

**Cruise Control:** ➔ P.215

## Instruments (Continued)

### Handle grip heater status icon

CRF1100A2/A4/D2/D4

The handle grip heater status icon will appear while the handle grip heater is on.

➔ P.132

**If the handle grip heater status icon flashes:**

➔ P.307



**[P] [Power] level indicator** ➔ P.142

When the indicator flashes, have your dealer check for problems.

**Torque Control level [T] indicator** ➔ P.133

When the indicator flashes, have your dealer check for problems.

**[S] [Overall] indicator** ➔ P.142

CRF1100A4/D4

When the indicator flashes, have your dealer check for problems.

**Air temperature gauge** ➡ P.66

## Tachometer

### NOTICE

Do not operate the engine in the Tachometer red zone.  
Excessive engine speed can adversely affect engine life.

## Tachometer red zone

(excessive engine rpm range)

## Fuel gauge

Remaining fuel when only E (1st) segment starts flashing:

Approximately 3.6 L (0.95 US gal, 0.79 Imp gal) (CRF1100A/D)

Approximately 3.9 L (1.03 US gal, 0.86 Imp gal) (CRF1100A2/A4/D2/D4)

**If the fuel gauge indicator flashes:** ➡ P.306

### NOTICE

You should refuel when the reading approaches the E (1st) segment.  
Running out of fuel can cause the engine to misfire, damaging the catalytic converter.



## Instruments *(Continued)*

### Basic Operations

You can operate and set the various functions of your vehicle using the switches on the left handlebar and  function switch on the right handlebar or touch screen. However, you cannot operate some functions while the vehicle is in motion.

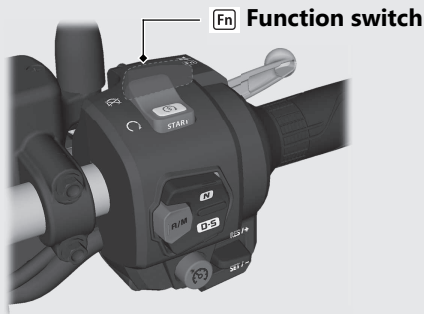

### To Return to the Home Screen

To return to the Home screen:  
Pull backward and hold the  page switch on the left handlebar or touch the clock area of the multi-information display with your vehicle stopped.

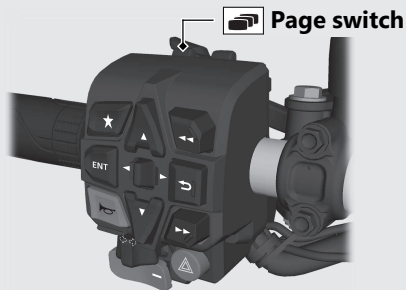

## To Select a Desired Setting Menu

To operate with the ▲ sel up switch or ▼ sel down switch on the left handlebar:

Press ▲ or ▼ to select the available choices.

To operate with the ◀▶ sel left/right switch on the left handlebar:

Push ◀ or ▶ to select the available choices.

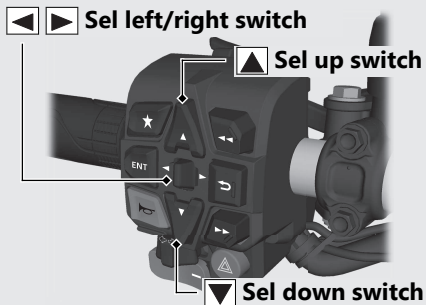

To operate with the touch screen:

Touch the menu to be selected on the touch screen.

## To Set Your Selection

To operate with the ENT switch on the left handlebar:

Press the ENT switch on the left handlebar to set your selection.

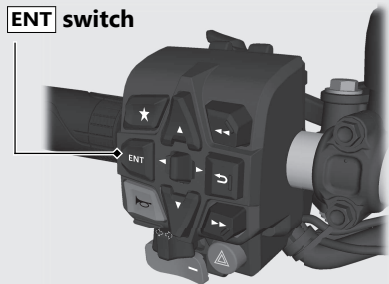

## Instruments *(Continued)*

To operate with the touch screen:

Touch the menu to be selected on the touch screen.

### To Exit the Setting Menu

To return to the riding information:

Pull backward the  page switch on the left handlebar.

To return to the Home screen:

Pull backward and hold the  page switch on the left handlebar.

To return the previous screen:

Press the  back switch on the left handlebar.

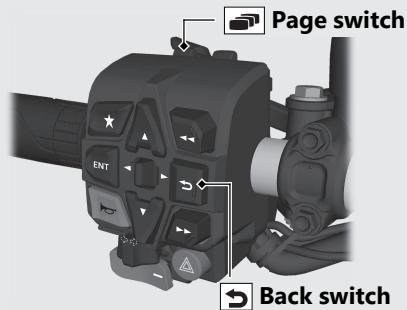

To operate with the touch screen:

Touch the  to be selected on the touch screen.

Also, the setting mode ends when your vehicle speed reaches approximately 6 km/h (4 mph).

**Page 1:**

Page 1 shows the following items: Tripmeter A [TRIP A] and three items related to Tripmeter A [TRIP A] and Tripmeter B [TRIP B]. ➔P.86

- Tripmeter A average fuel mileage [AVG. CONS.] display ➔P.46
- Tripmeter A average speed [AVG. SPD.] display ➔P.52
- Tripmeter A current fuel mileage [CONS.] display ➔P.48
- Tripmeter A elapsed [ELAPSED] display ➔P.49

1	2	3	4
<b>TRIP A</b>			
		60.0 km	
<b>AVG. CONS.</b>			
		5.6 l/100 km	
<b>AVG. SPD.</b>			
		55 km/h	
<b>CONS.</b>			
		6.6 L	

## Instruments *(Continued)*

### Page 2:

Page 2 shows the following items: Tripmeter B [TRIP B] and three items related to Tripmeter B [TRIP B]. ➔P.86

- Tripmeter B average fuel mileage [AVG. CONS.] display ➔P.51
- Tripmeter B average speed [AVG. SPD.] display ➔P.52
- Tripmeter B current fuel mileage [CONS.] display ➔P.53
- Tripmeter B elapsed [ELAPSED] display ➔P.54

1	2	3	4
TRIP B			
		30.0 km	
AVG. CONS.			
		6.2 l/100km	
AVG. SPD.			
		45 km/h	
CONS.			
		1.8 L	



**Page 3:**

Page 3 shows four items selected from the following items. ➡P.86

- Current fuel mileage [INST. CONS.] display ➡P.55
- Available driving distance [RANGE] display ➡P.56
- Battery voltage [VOLTAGE] display ➡P.57
- Date [DATE] display ➡P.57
- Average fuel mileage [AVG. CONS.] display ➡P.58
- Fuel consumption [CONS.] display ➡P.59
- Elapsed time [ELAPSED] display ➡P.59
- Subtraction trip [-TRIP] display ➡P.60

1	2	3	4
INST. CONS.		5.8 l/100 km	
AVG. CONS.		6.2 l/100 km	
CONS.		3.2 L	
ELAPSED		02:42	

## Instruments *(Continued)*

### Page 4:

Page 4 shows the setting values of the following items.

- ABS function on the rear wheel [ABS RR] display **P.61**
- Honda Selectable Torque Control level [HSTC] display **P.62**
- Wheelie Control level [W] display **P.63**
- **CRF1100A4/D4**  
Rear suspension preload level [PRELOAD] display **P.64**
- **CRF1100D/D2/D4**  
G switch [G] display **P.65**

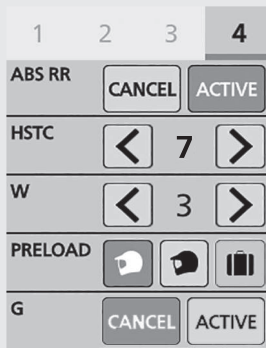

## To Switch the Page of Display

- 1 Select the gold image display. P.81
- 2 Push the or of the sel left/right switch until the desired page is displayed.

You can also perform the above settings by using the touch screen.

## To Switch the Page 1 or Fuel Gauge

- 1 Select the silver image display. P.81
- 2 Push the or of the sel left/right switch to switch the page or fuel gauge.

## Tripmeter A [TRIP A]

Distance ridden since the tripmeter A was reset.

1	2	3	4
TRIP A	60.0 km		
AVG. CONS.	5.6 l/100 km		
AVG. SPD.	55 km/h		
CONS.	6.6 L		

When "---.-" flashes, have your dealer check for problems.

## To reset the tripmeter A [TRIP A]:

P.68

## Instruments *(Continued)*

### Tripmeter A Average Fuel Mileage [AVG. CONS.]

Displays the average fuel mileage since the tripmeter A was reset.

The average fuel mileage will be calculated based on the value displayed on the selected tripmeter A. Also, the average fuel mileage for tripmeter A will be displayed when the odometer is selected.

Display range: 0.0 to 299.9 l/100 km (km/l, mpg or mile/L)

- Initial display: "---.-" is displayed.
- More than 299.9 l/100 km (km/l, mpg or mile/L): "299.9" is displayed.
- When the tripmeter A is reset: "---.-" is displayed.

1	2	3	4
TRIP A			
		60.0 km	
AVG. CONS.			
		5.6 l/100 km	
AVG. SPD.			
		55 km/h	
CONS.			
		6.6 L	

When "---.-" flashes, have your dealer check for problems.

**To reset the tripmeter A average fuel mileage [AVG. CONS.]:**  **P.68**

## Tripmeter A Average Speed [AVG. SPD.]

Displays the average speed since the tripmeter A was reset.

The average speed will be calculated based on the value displayed on the selected tripmeter A.

Also, the average speed for tripmeter A will be displayed when the odometer is selected.

- Initial display: "0" is displayed.

Display range: 0 to 299 km/h or 0 to 186 mph

1	2	3	4
TRIP A			
		60.0 km	
AVG. CONS.			
		5.6 l/100 km	
AVG. SPD.			
		55 km/h	
CONS.			
		6.6 L	

**To reset the tripmeter A average speed [AVG. SPD.]:**  **P.68**

## Instruments *(Continued)*

### Tripmeter A Fuel Consumption [CONS.]

Displays the tripmeter A fuel consumption since the tripmeter A was reset.

Display range: 0.0 to 300.0 L (gal)

- Above 300.0 L (gal): "300.0" is displayed.
- When the tripmeter A fuel consumption is reset: "---.-" is displayed.

1	2	3	4
TRIP A	60.0 km		
AVG. CONS.	5.6 l/100 km		
AVG. SPD.	55 km/h		
CONS.	6.6 L		

To reset the tripmeter A fuel consumption [CONS.]:  P.68

## ■ Tripmeter A Elapsed [ELAPSED]

Displays the tripmeter A elapsed since the tripmeter A was reset.

Display range: 00:00 to 99:59 (hours:minutes)

- The display locks at "99:59" when the read-out exceeds 99:59.

1	2	3	4
TRIP A			
		60.0 km	
AVG. CONS.			
		5.6 l/100 km	
AVG. SPD.			
		55 km/h	
ELAPSED			
		01:39	

When "00:00" flashes, have your dealer check for problems.

**To reset the tripmeter A elapsed [ELAPSED]:**  P.68

## Instruments *(Continued)*

### ■ Tripmeter B [TRIP B]

Distance ridden since the tripmeter B was reset.

1	2	3	4
TRIP B			
30.0 km			
AVG. CONS.			
6.2 l/100 km			
AVG. SPD.			
45 km/h			
CONS.			
1.8 L			

When “---.-” flashes, have your dealer check for problems.

### To reset the tripmeter B [TRIP B]:

➡ P.69



## Tripmeter B Average Fuel Mileage [AVG. CONS.]

Displays the average fuel mileage since the tripmeter B was reset.

The average fuel mileage will be calculated based on the value displayed on the selected tripmeter B. Also, the average fuel mileage for tripmeter B will be displayed when the odometer is selected.

Display range: 0.0 to 299.9 l/100 km (km/l, mpg or mile/L)

- Initial display: "---.-" is displayed.
- More than 299.9 l/100 km (km/l, mpg or mile/L): "299.9" is displayed.
- When the tripmeter B is reset: "---.-" is displayed.

1	2	3	4
TRIP B			
		30.0 km	
AVG. CONS.		6.2 l/100 km	
AVG. SPD.		45 km/h	
CONS.		1.8 L	

When "---.-" flashes, have your dealer check for problems.

**To reset the tripmeter B average fuel mileage [AVG. CONS.]:**  P.69

## Instruments *(Continued)*

### Tripmeter B Average Speed [AVG. SPD.]

Displays the average speed since the tripmeter B was reset.

The average speed will be calculated based on the value displayed on the selected tripmeter B.

Also, the average speed for tripmeter B will be displayed when the odometer is selected.

- Initial display: "0" is displayed.

Display range: 0 to 299 km/h or 0 to 186 mph

1	2	3	4
TRIP B		30.0 km	
AVG. CONS.		6.2 l/100 km	
AVG. SPD.		45 km/h	
CONS.		1.8 L	

**To reset the tripmeter B average speed [AVG. SPD.]:**  **P.69**

## Tripmeter B Fuel Consumption [CONS.]

Displays the tripmeter B fuel consumption since the tripmeter B was reset.

Display range: 0.0 to 300.0 L (gal)

- Above 300.0 L (gal): "300.0" is displayed.
- When the tripmeter B fuel consumption is reset: "---.-" is displayed.

1	2	3	4
TRIP B			
30.0 km			
AVG. CONS.			
6.2 l/100 km			
AVG. SPD.			
45 km/h			
CONS.			
1.8 L			

To reset the tripmeter B fuel consumption [CONS.]:  P.69

## Instruments *(Continued)*

### ▮ Tripmeter B Elapsed [ELAPSED]

Displays the tripmeter B elapsed since the tripmeter B was reset.

Display range: 00:00 to 99:59 (hours:minutes)

- The display locks at "99:59" when the read-out exceeds 99:59.

1	2	3	4
TRIP B			
30.0 km			
AVG. CONS.			
6.2 l/100 km			
AVG. SPD.			
45 km/h			
ELAPSED			
00:39			

When "00:00" flashes, have your dealer check for problems.

### To reset the tripmeter B elapsed

[ELAPSED]:  P.69

## Current Fuel Mileage [INST. CONS.]

Displays the current instant fuel mileage  
 Display range: 0.0 to 299.9 l/100 km (km/l, mpg or mile/L)

- When your speed is less than 3 km/h (1 mph): "--.-" is displayed.
- Above 299.9 l/100 km (km/l, mpg or mile/L): "299.9" is displayed.

1	2	3	4
<b>INST. CONS.</b>			
		5.8	l/100 km
<b>AVG. CONS.</b>			
		6.2	l/100 km
<b>CONS.</b>			
		3.2	L
<b>ELAPSED</b>			
		02:42	

When "--.-" flashes, have your dealer check for problems.

## Instruments *(Continued)*

### Available Driving Distance [RANGE]

Displays the estimated distance you can travel on the remaining fuel.

Display range: 999 to 0 km (999 to 0 mile)

- Above 999 km (mile): "999" is displayed.
- Initial display: "0" is displayed.
- When the available driving distance is below 5 km (3 mile) or the amount of remaining fuel is below 1.0 L (0.2 gal), "---" is displayed.

1	2	3	4
INST. CONS.		5.8 <small>l/100 km</small>	
AVG. CONS.		6.2 <small>l/100 km</small>	
RANGE		32 km	
-TRIP		155 km	

## Battery Voltage [VOLTAGE]

Displays the current battery voltage.

Display range: 7.5 to 18.5 V

1	2	3	4
INST. CONS.		5.8 l/100 km	
AVG. CONS.		6.2 l/100 km	
VOLTAGE		 12.0 v	
DATE		Wed, 15, May, 2019	

When “---.-” flashes, have your dealer check for problems.

## Date [DATE]

Displays today's date.

1	2	3	4
INST. CONS.		5.8 l/100 km	
AVG. CONS.		6.2 l/100 km	
VOLTAGE		 12.0 v	
DATE		Wed, 15, May, 2019	

To set the current date:  **P.90**

## Instruments *(Continued)*

### Average Fuel Mileage [AVG. CONS.]

Displays the average fuel mileage since the engine was started.

Display range: 0.1 to 299.9 l/100 km (km/l, mpg or mile/L)

- Initial display: "---.-" is displayed.
- More than 299.9 l/100 km (km/l, mpg or mile/L): "299.9" is displayed.
- When the average fuel mileage [AVG. CONS.] is reset: "---.-" is displayed.

1	2	3	4
INST. CONS.		5.8 l/100 km	
AVG. CONS.		6.2 l/100 km	
CONS.		3.2 L	
ELAPSED		02:42	

When "---.-" flashes, have your dealer check for problems.

**To reset the average fuel mileage [AVG. CONS.]:**  **P.70**



## Fuel Consumption [CONS.]

Displays the fuel consumption since the engine was started.

Display range: 0.0 to 300.0 L or 0.0 to 300.0 gal

- Above 300.0 L (gal): "300.0" is displayed.
- When the engine is starts: "---.-" is displayed.

1	2	3	4
<b>INST. CONS.</b>			
		5.8	l/100 km
<b>AVG. CONS.</b>			
		6.2	l/100 km
<b>CONS.</b>			
		3.2	L
<b>ELAPSED</b>			
		02:42	

## Elapsed Time [ELAPSED]

Displays operating time since the engine was started.

Display range: 00:00 to 99:59 (hours:minutes)

- The display locks at "99:59" when the read-out exceeds 99:59.

1	2	3	4
<b>INST. CONS.</b>			
		5.8	l/100 km
<b>AVG. CONS.</b>			
		6.2	l/100 km
<b>CONS.</b>			
		3.2	L
<b>ELAPSED</b>			
		02:42	

When "00:00" flashes, have your dealer check for problems.

## Instruments *(Continued)*

### Subtraction Trip [-TRIP]

Distance travelled is subtracted from a preset figure, since the subtraction trip was set up.

Display range: 1,607.3 to -1,609.0 km or 999.0 to -1,000.0 mile

The display locks at "-1609.0" km ("-1000.0" mile) when the read-out exceeds -1609.0 km (-1000.0 mile).

To set the subtraction trip:  P.78

**Default:** 000

1	2	3	4
INST. CONS.			
		5.8 <small>l/100 km</small>	
AVG. CONS.			
		6.2 <small>l/100 km</small>	
RANGE			
		32 km	
-TRIP			
		155 km	

## ABS Function on the Rear Wheel [ABS RR]

Displays the selected status of the ABS function on the rear wheel [ABS RR].



**Available settings:** [ACTIVE]/[CANCEL]

**Default:** [ACTIVE]

**To select the ABS function on the rear wheel [ABS RR]:** P.122

## Instruments *(Continued)*

### Honda Selectable Torque Control Level [HSTC]

Display the selected value of the Honda Selectable Torque Control level [HSTC].



**Setting range:** Level 1 to 7 or 0 (Off)

**To select the Honda Selectable Torque Control level [HSTC]:** **P.133**

## Wheelie Control Level [W]

Display the selected value of the wheelie control level [W].



**Setting range:** Level 1 to 3 or 0 (Off)

**To select the wheelie control level [W]:**

➔ P.138













## Instruments *(Continued)*

### Rear Suspension Preload Mode [PRELOAD]

CRF1100A4/D4

Displays the selected status of the rear suspension preload mode [PRELOAD].



Status icon	Riding condition
  	Rider only (Minimum preload)
  	Rider and luggage
  	Rider and passenger
  	Rider, passenger and luggage (Maximum preload)

**Default:** Rider only

**To select the rear suspension preload mode [PRELOAD]:**  P.291

## G Switch [G]

CRF1100D/D2/D4

Displays the selected status of the G switch [G].

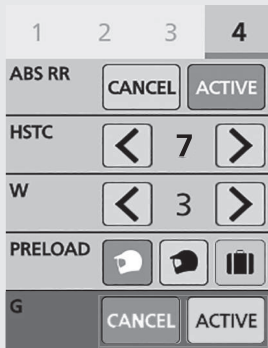

**Available settings:** [ACTIVE]/[CANCEL]

**Default:**

- [TOUR MODE]: [CANCEL]
- [URBAN MODE]: [CANCEL]
- [GRAVEL MODE]: [CANCEL]
- [OFF ROAD MODE]: [ACTIVE]
- [USER 1 MODE]: [CANCEL]
- [USER 2 MODE]: [CANCEL]

**To select the G switch [G]:** P.126

## Instruments *(Continued)*

### Side Stand Indicator

The side stand indicator comes on when the side stand is put down. It goes off when the side stand is raised.

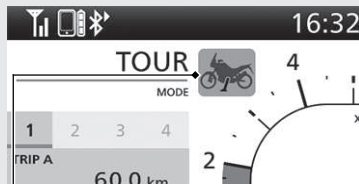

**Side stand indicator**

### Air temperature gauge

Displays the ambient temperature.



**Air temperature gauge**



Display range: -10 °C to 50 °C

- Below -11°C: "---" is displayed
- Above 50°C: 50°C flashes

Road heat and exhaust from another vehicle can affect the temperature reading when your vehicle speed is less than 30 km/h (19 mph). It may take several minutes for the display to be updated after the temperature reading has stabilized.

## Cruise Control Set Speed

The speed set for cruise control is displayed.



**Cruise control set speed**

**To set the cruise control set speed:**

**➔ P.217**

## Instruments *(Continued)*

### To Reset the Tripmeter A [TRIP A], Tripmeter A Average Fuel Mileage [AVG. CONS.], Tripmeter A Average Speed [AVG. SPD.], Tripmeter A Fuel Consumption [CONS.] and Tripmeter A Elapsed [ELAPSED]

To reset the tripmeter A [TRIP A], tripmeter A average fuel mileage [AVG. CONS.], tripmeter A average speed [AVG. SPD.], tripmeter A fuel consumption [CONS.] and tripmeter A elapsed [ELAPSED], press and hold the **ENT** switch while page 1 is displayed or touch and hold the page 1 area.

1	2	3	4
TRIP A	60.0 km		
AVG. CONS.	5.6 l/100km		
AVG. SPD.	55 km/h		
CONS.	6.6 L		

**To Reset the Tripmeter B [TRIP B],  
Tripmeter B Average Fuel Mileage  
[AVG. CONS.], Tripmeter B Average  
Speed [AVG. SPD.], Tripmeter B Fuel  
Consumption [CONS.] and Tripmeter B  
Elapsed [ELAPSED]**

To reset the tripmeter B [TRIP B], tripmeter B average fuel mileage [AVG. CONS.], tripmeter B average speed [AVG. SPD.], tripmeter B fuel consumption [CONS.] and tripmeter B elapsed [ELAPSED], press and hold the **ENT** switch while page 2 is displayed or touch and hold the page 2 area.

1	2	3	4
TRIP B	30.0 km		
AVG. CONS.	6.2 l/100 km		
AVG. SPD.	45 km/h		
CONS.	1.8 L		

## Instruments *(Continued)*









### To Reset the Average Fuel Mileage [AVG. CONS.]

To reset the average fuel mileage [AVG. CONS.], press and hold the **ENT** switch while page 3 is displayed or touch and hold the page 3 area.

1	2	3	4
INST. CONS.		5.8 l/100km	
AVG. CONS.		6.2 l/100km	
CONS.		3.2 L	
ELAPSED		02:42	







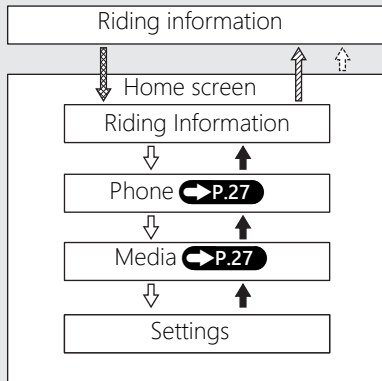

## Setting mode

### To Shift to the Menu of the Multi-Information Display

-  Pull backward and hold the  page switch or touch the clock area of the multi-information display.
-  Select [Riding Information], and then press the **ENT** switch or touch the [Riding Information] of the multi-information display.
-  Pull backward the  page switch.
-  Press the  sel up switch.
-  Press the  sel down switch.



## Instruments *(Continued)*

-  Press the **ENT** switch.
-  Press the  back switch or touch the  of the multi-information display.
-  Press the  sel up switch.
-  Press the  sel down switch.

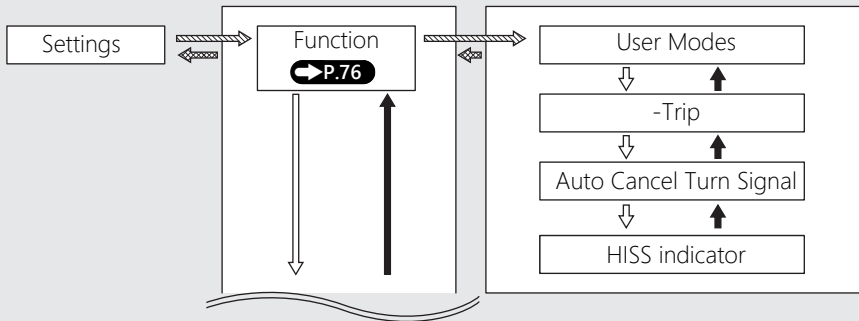

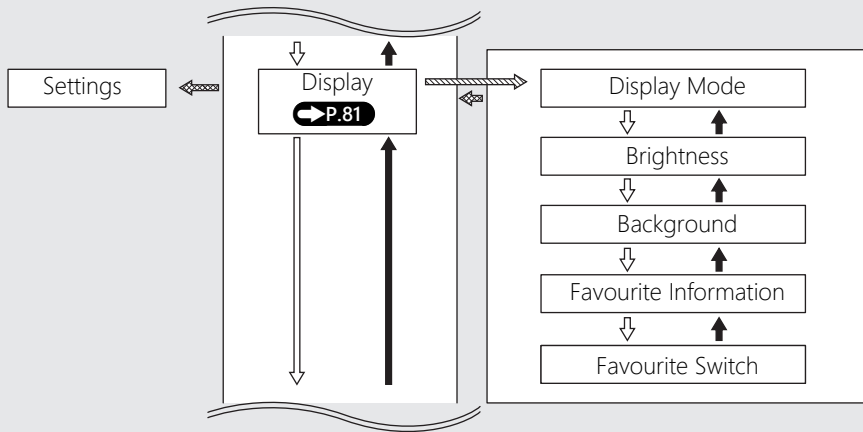

## Instruments *(Continued)*

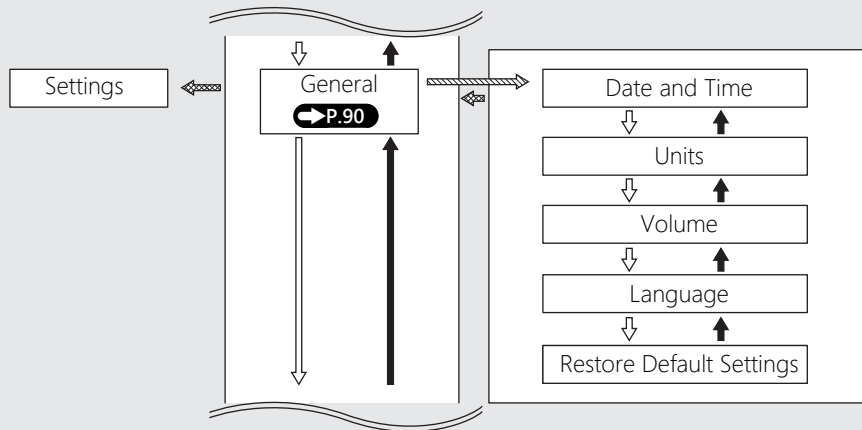



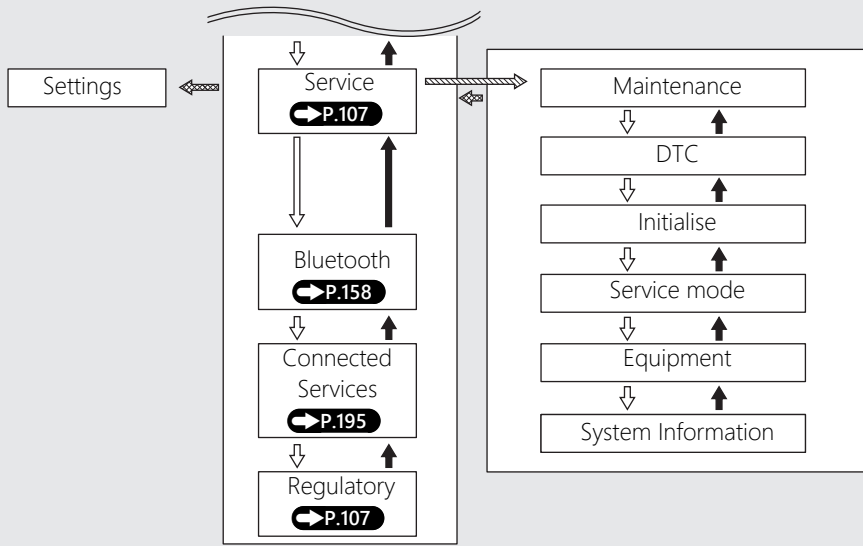



## Instruments *(Continued)*

### Function

Following items can be changed sequentially.

- User Modes (this page)
- -Trip  **P.78**
- Auto Cancel Turn Signal  **P.79**
- HISS indicator  **P.80**

### User Modes

You can change the [Power], [Engine Brake], [Overall], [Front], [Rear], [ABS], [Preload] values in [USER 1 MODE] and [USER 2 MODE].

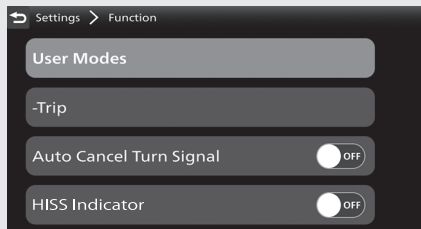

- 1 Select [User Modes], and then press the **ENT** switch.
- 2 Select [User 1] or [User 2] using the ▲ sel up or ▼ sel down switch, and then press the **ENT** switch.

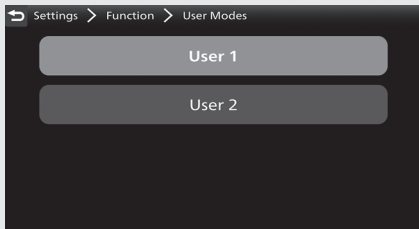

- 3 Press the ▲ sel up switch or ▼ sel down switch to select a setting menu.
- 4 Push the ◀ or ▶ of the ◀▶ sel left/right switch until the desired value is displayed.
  - ▶ Push and hold the ◀ or ▶ of the ◀▶ sel left/right switch to advance the figure fast.

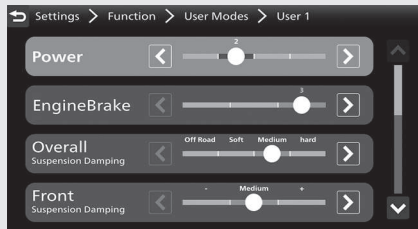

- 5 Return to the riding information, previous screen or Home screen. ➡P.40  
You can also perform the above settings by using the touch screen.

**Available settings:** ➡P.146

**Default:** ➡P.144

## Instruments *(Continued)*

### -Trip

You can also adjust value of the subtraction trip [-TRIP].

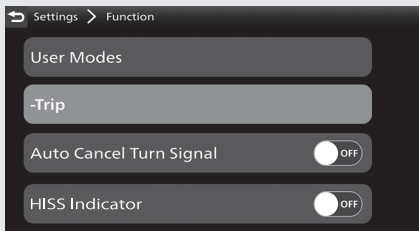

- 1 Select [-Trip], and then press the **ENT** switch.
- 2 Select the digits using the or of the sel left/right switch.
- 3 To increase value: Press the sel up switch, until the desired value is displayed.  
To decrease value: Press the sel down switch, until the desired value is displayed.

- ▶ Press and hold the sel up switch or sel down switch to advance the figure fast.

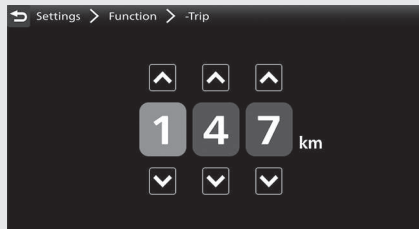

- 4 Return to the riding information, previous screen or Home screen. **P.40**

You can also perform the above settings by using the touch screen.

**Setting range:** 000 to 999

**Default:** 000

## Auto Cancel Turn Signal

You can enable/disable turn signal automatic cancellation.

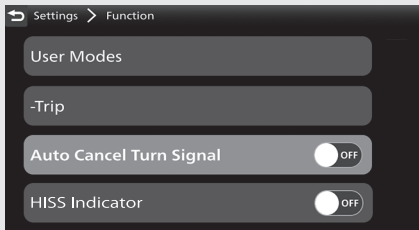

- 1 Select [Auto Cancel Turn Signal], and then press the **ENT** switch to [ON] (enable) or [OFF] (disable) the function.
- 2 Return to the riding information, previous screen or Home screen. **➡ P.40**

You can also perform the above settings by using the touch screen.

**Available settings:** [ON]/[OFF]

**Default:** [ON]

## Instruments *(Continued)*

### HISS Indicator

You can select the blink or off the HISS indicator.

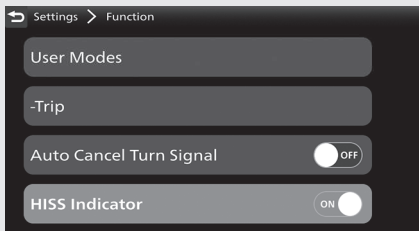

- 1 Select [HISS Indicator], and then press the **ENT** switch to select [ON] (blink) or [OFF] (off) the function.
- 2 Return to the riding information, previous screen or Home screen. **➡P.40**

You can also perform the above settings by using the touch screen.

**Available settings:** [ON]/[OFF]

**Default:** [ON]

## Display

Following items can be changed sequentially.

- Display Mode (this page)
- Brightness → P.83
- Background → P.84
- Favourite Information → P.86
- Favourite Switch → P.88

## Display Mode

You can select the riding information image.

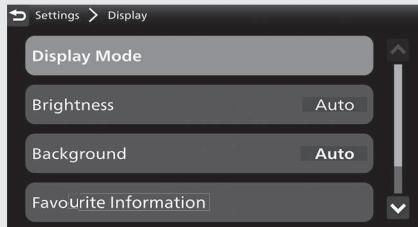

## Instruments (Continued)

- 1 Select [Display Mode], and then press the **ENT** switch.
- 2 Press the ▲ sel up switch or ▼ sel down switch to select a setting menu.
- 3 Push the ◀ or ▶ of the ◀ ▶ sel left/right switch to select your desired display.

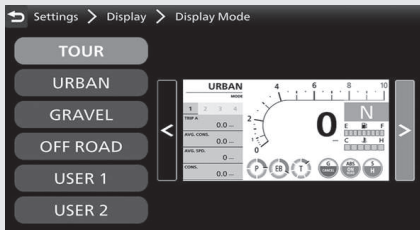

- 4 Return to the riding information, previous screen or Home screen. ➡ **P.40**

You can also perform the above settings by using the touch screen.

**Available settings:** Gold image/Silver image/Bronze image

### Default:

- [TOUR MODE]: Gold image
- [URBAN MODE]: Silver image
- [GRAVEL MODE]: Silver image
- [OFF ROAD MODE]: Bronze image
- [USER 1 MODE]: Silver image
- [USER 2 MODE]: Bronze image



## Brightness

You can select the backlight brightness.

The display can become dark when the display is very hot. If it does not restore the original brightness, contact your dealer.

### Automatic Brightness Control: P.345

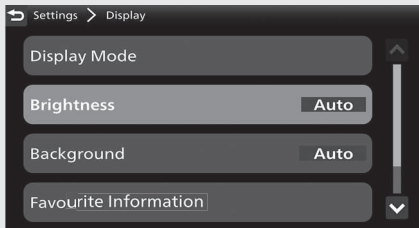

- 1 Select [Brightness], and then press the **ENT** switch.
- 2 Select [Auto], and then press the **ENT** switch to [ON] (auto) or [OFF] (manual) the function.

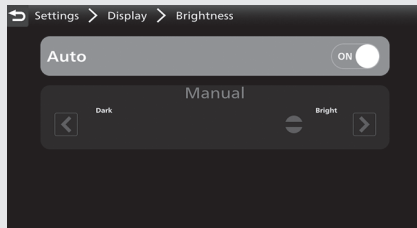

## Instruments *(Continued)*

- 3 If you select to [OFF] (manual) push the ◀ or ▶ of the ◀▶ sel left/right switch to select your preferred level.
- ▶ Push and hold the ◀ or ▶ of the ◀▶ sel left/right switch to advance the figure fast.

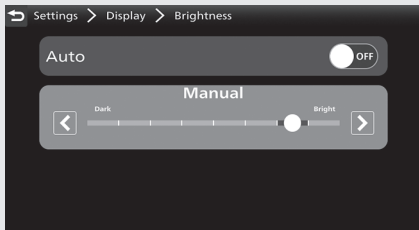

- 4 Return to the riding information, previous screen or Home screen. ➡ P.40

You can also perform the above settings by using the touch screen.

**Setting range:** Level 1 to 8 or [Auto]

**Default:** [Auto]

## Background

You can select the background.

### Automatic Background Control:

➡ P.345

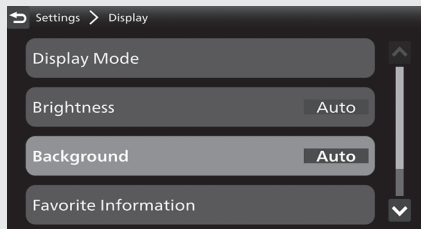

- 1 Select [Background], and then press the **ENT** switch.
- 2 Select [Auto], and then press the **ENT** switch to [ON] (auto) or [OFF] (manual) the function.
- 3 If you select to [ON] (auto), push the ◀ or ▶ of the ◀▶ sel left/right switch to select your preferred level.
  - ▶ Push and hold the ◀ or ▶ of the ◀▶ sel left/right switch to advance the figure fast.

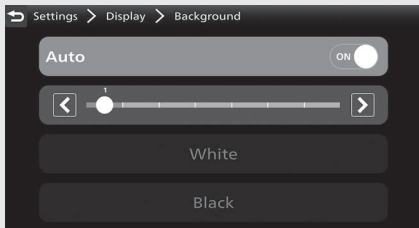

If you select to [OFF] (manual), press the ▲ sel up switch or ▼ sel down switch to select the [White] or [Black].

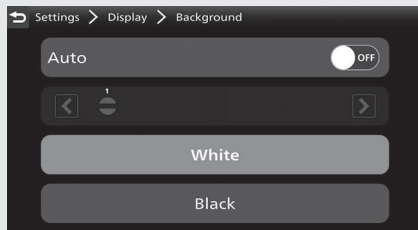

- 4 Return to the riding information, previous screen or Home screen. ➔ **P.40**
- You can also perform the above settings by using the touch screen.

**Setting range:** Auto Level 1 to 7, White or Black

**Default:** Auto 1

## Instruments *(Continued)*





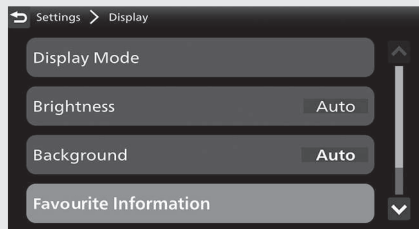

### Favourite Information

You can select the following:



- Page 1
  - Tripmeter A average fuel mileage [AVG. CONS.]
  - Tripmeter A average speed [AVG. SPD.]
  - Tripmeter A current fuel mileage [CONS.]
  - Tripmeter A elapsed [ELAPSED]
  - Tripmeter B [TRIP B]
- Page 2
  - Tripmeter B average fuel mileage [AVG. CONS.]
  - Tripmeter B average speed [AVG. SPD.]
  - Tripmeter B current fuel mileage [CONS.]
  - Tripmeter B elapsed [ELAPSED] display

- Page 3
  - Current fuel mileage [INST. CONS.]
  - Available driving distance [RANGE]
  - Battery voltage [VOLTAGE]
  - Date [DATE]
  - Average fuel mileage [AVG. CONS.]
  - Fuel consumption [CONS.]
  - Elapsed time [ELAPSED]
  - Subtraction trip [-TRIP]



- 1 Select [Favourite Information], and then press the **ENT** switch.
- 2 Push the  or  of the   sel left/right switch until the desired page is displayed.
- 3 Press  /  to select the available choices, and then press the **ENT** switch.



- 4 Press  /  to select the available choices, and then press the **ENT** switch.



- 5 Return to the riding information, previous screen or Home screen. **➡ P.40**  
 You can also perform the above settings by using the touch screen.

## Instruments *(Continued)*

### Default:

- Page 1
  - Tripmeter A average fuel mileage [AVG. CONS.]
  - Tripmeter A average speed [AVG. SPD.]
  - Tripmeter A current fuel mileage [CONS.]
- Page 2
  - Tripmeter B average fuel mileage [AVG. CONS.]
  - Tripmeter B average speed [AVG. SPD.]
  - Tripmeter B current fuel mileage [CONS.]
- Page 3
  - Current fuel mileage [INST. CONS.]
  - Available driving distance [RANGE]
  - Battery voltage [VOLTAGE]
  - Date [DATE]

### Favourite Switch



- 1 Select [Favourite Switch], and then press the **ENT** switch.
- 2 Press the ▲ sel up switch or ▼ sel down switch to select your desired mode.

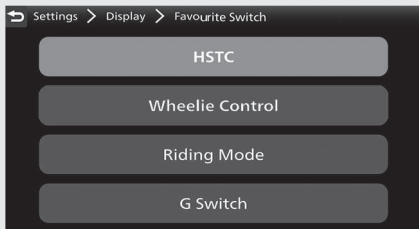

- 3 Return to the riding information, previous screen or Home screen. ➡ **P.40**

You can also perform the above settings by using the touch screen.

**Available settings:** [HSTC]/  
[Wheelie Control]/[Riding Mode]/  
[G Switch] **CRF1100D/D2/D4**

**Default:** [HSTC]

## Instruments *(Continued)*

### General

Following items can be changed sequentially.

- Date and Time (this page)
- Units → P.93
- Volume → P.95
- Language → P.97

### Date and Time

The multi-information display receives signals from GPS satellites and updates the date and time automatically.

You can also adjust the date and time manually.

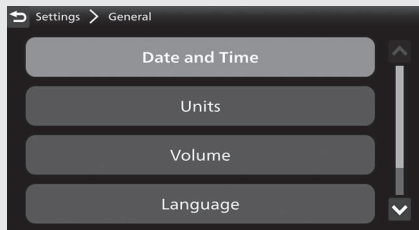



To [ON] (auto) or [OFF] (manual) adjust time automatically function:

- 1 Select [Date and Time], and then press the **ENT** switch.
- 2 Select [Adjust Time Automatically], and then press the **ENT** switch to [ON] (auto) or [OFF] (manual) the function.

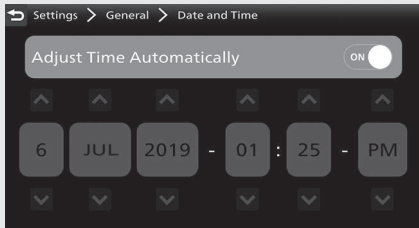

When GPS cannot be located. Read the notice message, and then press the **ENT** switch.

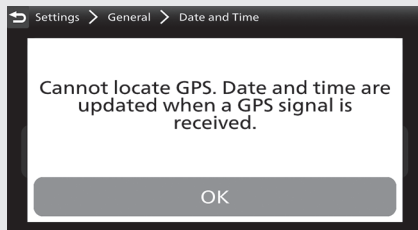

- 3 Return to the riding information, previous screen or Home screen. **➡ P.40**
- You can also perform the above settings by using the touch screen.

## Instruments *(Continued)*

To adjust the clock manually:

- 1 Select [Date and Time], and then press the **ENT** switch.
- 2 Select [Adjust Time Automatically], and then press the **ENT** switch to [OFF] (manual) the function.

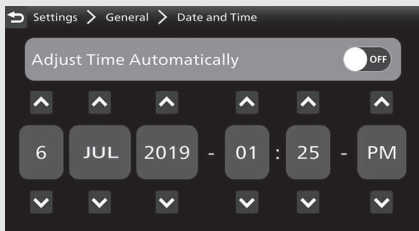

- 3 Press **◀** / **▶** on the sel **◀ ▶** left/right switch to select a day, month, year, hour, minute or time format section.
  - To advance the day, month, year, hour or minute: Press the **▲** sel up switch, and then press the **ENT** switch until the desired value is displayed. To delay the day, month, year, hour or minute: Press the **▼** sel down switch, and then press the **ENT** switch until the desired value is displayed.
    - ▶ Press and hold the **ENT** switch to advance the figure fast.
  - To select the time format: Press the **▲** sel up switch or **▼** sel down switch, and then press the **ENT** switch until the desired time format is displayed.
    - ▶ Press and hold the **ENT** switch to advance the figure fast.

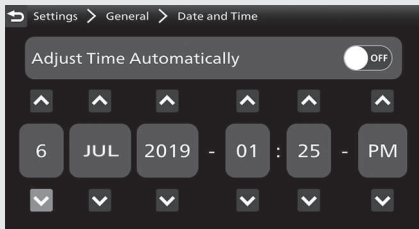

- 4 Return to the riding information, previous screen or Home screen. ➔ P.40

You can also perform the above settings by using the touch screen.

**Available settings:** [ON] (auto)/[OFF] (manual)

**Default:** [ON] (auto)

## Units

You can change the following units.

- [Speed]: [km/h] or [mph]
- [Fuel Consumption]: [l/100 km] or [km/l]  
If the [mph] for speed is selected, the fuel mileage shown by [mpg] or [mile/L].

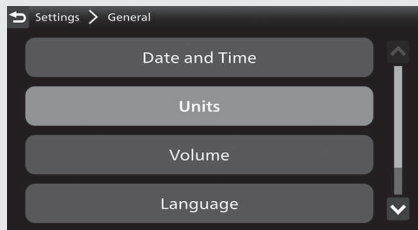

## Instruments *(Continued)*

- 1 Select [Units], and then press the **ENT** switch.
- 2 Press the **▲** sel up switch or **▼** sel down switch to select a setting menu.
- 3 Push the **◀** or **▶** of the **◀▶** sel left/right switch to select your desired unit.



- 4 Return to the riding information, previous screen or Home screen. **➡ P.40**

You can also perform the above settings by using the touch screen.

### Available settings:

- [Speed]: [km/h]/[mph]
- [Fuel Consumption]: [l/100 km]/[km/l]/[mpg]/[mil/L]

### Default:

- [Speed]: [km/h]
- [Fuel Consumption]: [l/100 km]

## Volume

Selects the volume setting to automatically increase volume from the headsets as the speed of the vehicle increases.

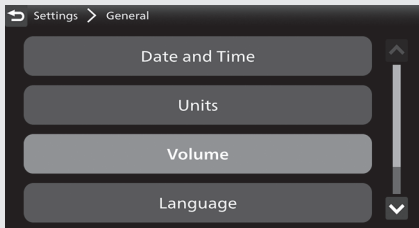

To [Off] (disable), [Low] or [High] automatic volume function:

- 1 Select [Volume], and then press the **ENT** switch.
- 2 Select [Automatic Volume], and then press the **ENT** switch.

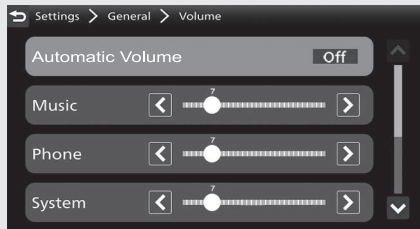

- 3 Press the **▲** sel up switch or **▼** sel down switch to set your selection.

## Instruments *(Continued)*

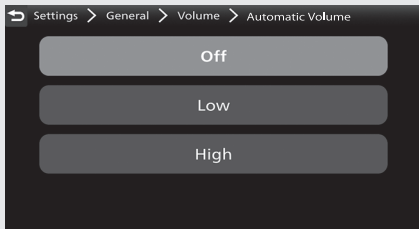

- 4 Return to the riding information, previous screen or Home screen. **→ P.40**

You can also perform the above settings by using the touch screen.

**Available settings:** [Off] (disable)/[Low]/[High]

**Default:** [Off] (disable)

To adjust the volume:

- 1 Select [Volume], and then press the **ENT** switch.
- 2 Press the ▲ sel up switch or ▼ sel down switch to select a setting menu.
- 3 Push the ◀ or ▶ of the ◀ ▶ sel left/right switch to select your preferred level.
  - ▶ Push and hold the ◀ or ▶ of the ◀ ▶ sel left/right switch to advance the figure fast.

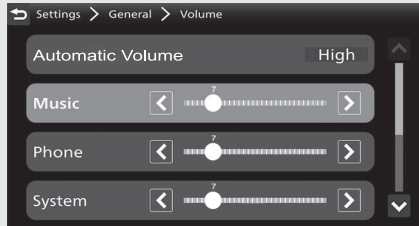

- 4 Return to the riding information, previous screen or Home screen. **→P.40**

You can also perform the above settings by using the touch screen.

### **VOLUME level range:**

Other than Microphone: Level 0 to 30

Micro phone: Level 0 to 14

### **Default:**

- Music: 7
- Phone: 7
- System: 7
- Ringtone: 7
- Voice: 7
- CarPlay: 7
- Microphone: 7

## **Language**

Changes the system language.

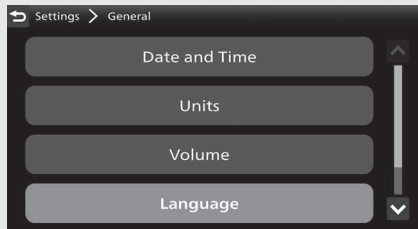

- 1 Select [Language], and then press the **ENT** switch.
- 2 Press the **▲** sel up switch or **▼** sel down switch to select the display language that you want to use on the screen

## Instruments (Continued)

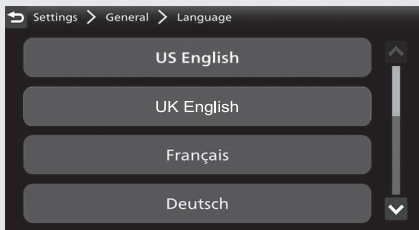

- Return to the riding information, previous screen or Home screen. **→ P.40**

You can also perform the above settings by using the touch screen.

**Default:** [UK English]

## Restore Default Settings

The set values can be returned to default settings.

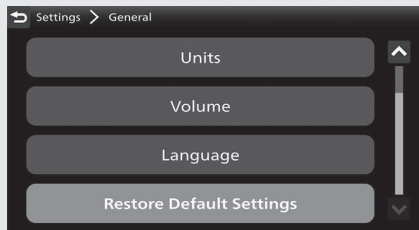

- Select [Restore Default Settings], and then press the **ENT** switch.



- 2 Select the [No] (not restore) or [Yes] (restore) using the ▲ sel up or ▼ sel down switch.

3 **When the [No] is selected**

Press the **ENT** switch.

The set value is maintained, and then the display returns to the [General] menu screen.

**When the [Yes] is selected**

Press the **ENT** switch.

The display changes to the confirmation screen.



- 4 Select the [No] (not restore) or [Yes] (restore) using the ▲ sel up or ▼ sel down switch on the confirmation screen.

5 **When the [No] is selected**

Press the **ENT** switch.

The set value is maintained, and then the display returns to the [General] menu screen.

**When the [Yes] is selected**

Press the **ENT** switch.

The set value return to default setting, and then the display returns to the [General] menu screen.

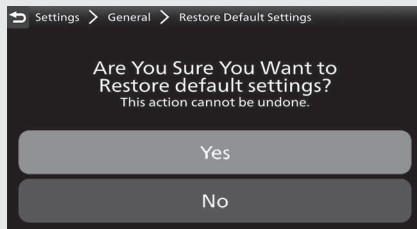

## Instruments *(Continued)*

- 6 Return to the riding information, previous screen or Home screen.  **P.40**

You can also perform the above settings by using the touch screen.

### Default setting values:

- -TRIP: 000
- Display mode:
  - ▶ [TOUR MODE]: Gold image
  - ▶ [URBAN MODE]: Silver image
  - ▶ [GRAVEL MODE]: Silver image
  - ▶ [OFF ROAD MODE]: Bronze image
  - ▶ [USER 1 MODE]: Silver image
  - ▶ [USER 2 MODE]: Bronze image
- Brightness: Auto
- Background: Auto 1
- Favourite information:
  - ▶ Page 1:
    - Tripmeter A average fuel mileage [AVG. CONS.]
    - Tripmeter A average speed [AVG. SPD.]
    - Tripmeter A current fuel mileage [CONS.]
  - ▶ Page 2:
    - Tripmeter B average fuel mileage [AVG. CONS.]
    - Tripmeter B average speed [AVG. SPD.]
    - Tripmeter B current fuel mileage [CONS.]
  - ▶ Page 3:
    - Current fuel mileage [INST. CONS.]
    - Available driving distance [RANGE]
    - Battery voltage [VOLTAGE]
    - Date [DATE]

- Favourite switch: [HSTC]
- Automatic Volume: [OFF]
- Periodic Maintenance:
  - Distance: "-----"
  - Date: "----/--"
- Oil Change:
  - Distance: "-----"
  - Date: "----/--"
- Delete the *Bluetooth*<sup>®</sup> paired device

## Service

Following items can be changed sequentially.

- Maintenance → P.102
- DTC → P.104
- Initialise → P.105
- Service mode → P.106
- Equipment → P.107
- System Information → P.107

## Instruments *(Continued)*

### Maintenance

You can check the next periodic inspection time and next engine oil change.

You can change the setting of the next periodic inspection and next engine oil change.

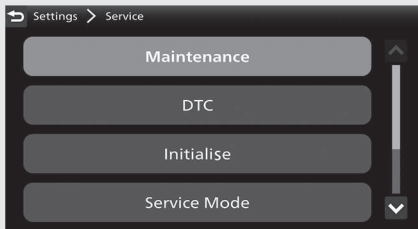

- 1 Select [Maintenance], and then press the **ENT** switch.
- 2 Press the ▲ sel up switch or ▼ sel down switch to select a setting menu, and then press the **ENT** switch.

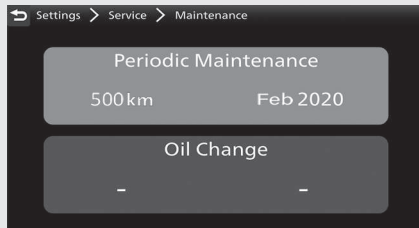

- 3 Press ◀ or ▶ of the ◀ ▶ sel left/right switch to select a distance, month or year section.

- To advance the distance, month or year: Press the ▲ sel up switch, and then press the ENT switch until the desired value is displayed.  
To delay the distance, month or year: Press the ▼ sel down switch, and then press the ENT switch until the desired value is displayed.
- ▶ Press and hold the ENT switch to advance the figure fast.

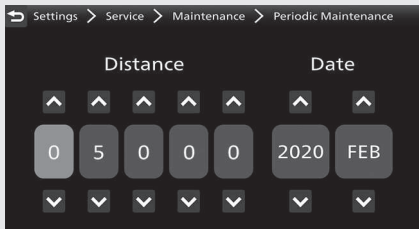

- 4 Return to the riding information, previous screen or Home screen. ➡ P.40

You can also perform the above settings by using the touch screen.

### Setting range:

- Periodic Maintenance:
  - Distance: 100 to 12,000 km or 100 to 8,000 mile
  - Date: 2000/JAN to 2099/DEC
- Oil Change:
  - Distance: 100 to 12,000 km or 100 to 8,000 mile
  - Date: 2000/JAN to 2099/DEC

### Default:

- Periodic Maintenance:
  - Distance: "-----"
  - Date: "----/---"
- Oil Change:
  - Distance: "-----"
  - Date: "----/---"

## Instruments *(Continued)*

### DTC

You can check for a current problem with the PGM-FI system.

If your vehicle has problem, DTC index is displayed.

Reduce speed and have your vehicle inspected by your dealer as soon as possible.

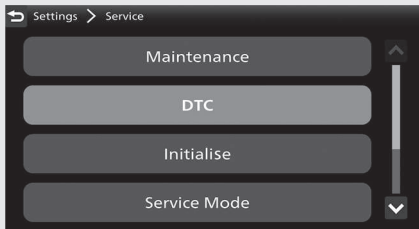

- 1 Select [DTC], and then press the **ENT** switch.

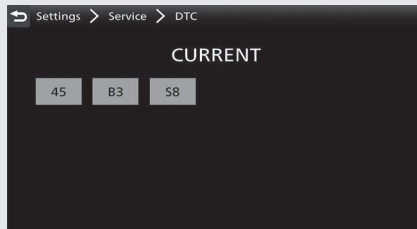

- 2 Return to the riding information, previous screen or Home screen. **➡ P.40**

You can also perform the above settings by using the touch screen.

## Initialise

You can calibrate of the touch screen.

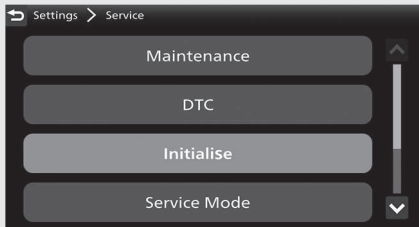

- 1 Select [Initialise], and then press the **ENT** switch.
- 2 Select [Touchscreen Calibration], and then press the **ENT** switch.

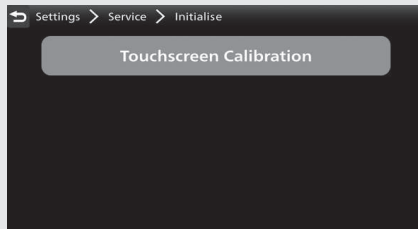

## Instruments *(Continued)*

- 3 Touch the centre of the cross four times.
  - ▶ The screen flashes green when calibration is complete.
  - If calibration fails, the screen flashes red.
  - Try step 3 again.



- 4 Return to the riding information, previous screen or Home screen. ➡ P.40
- You can also perform the above settings by using the touch screen.

## Service Mode

The DRL and cornering light (CRF1100A2/A4/D2/D4) can be turned on when the vehicle is stopped for inspection.

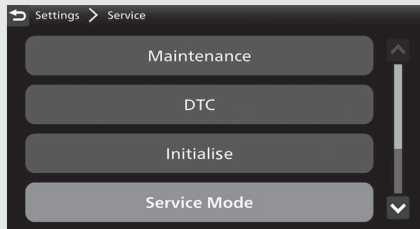

- 1 Start the engine. ➡ P.206
- 2 Stop the vehicle.
- 3 Select [Service Mode], and then press the **ENT** switch.



**4** CRF1100A2/A4/D2/D4

Press the ▲ sel up switch or ▼ sel down switch to select a menu.

**5** Press the **ENT** switch.

The light of the selected menu lights up.

- ▶ The service mode will automatically stop in 5 minutes.

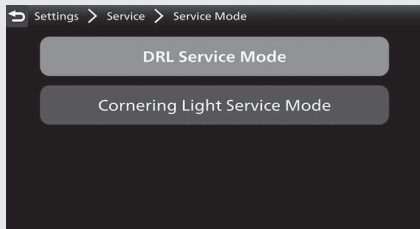
**6** Return to the riding information, previous screen or Home screen. ➡ **P.40**

You can also perform the above settings by using the touch screen.

**Equipment**

This menu cannot be selected.

**System Information**

Shows various information of the multi-information display.

- [Software Version]
- [Software update]: Cannot be selected.
- [Hardware Information]
- [GPS Reception Status]
- [EULAs]
- [Copyright and Acknowledgements]

**Regulatory**

Shows regulatory information of the multi-information display.

## Instruments *(Continued)*



### Pop-up information

In the following cases, pop-up information is displayed at the bottom of the multi-information display.

- Maintenance information:

When the inspection time of your vehicle is approaching.

### Maintenance information

Indication	Explanation	Remedy
	When the periodic inspection time of your vehicle is approaching	Have your vehicle inspected by your dealer.
	When the oil change time of your vehicle is approaching	Change the engine oil. 



# Indicators

If one of these indicators does not come on when it should, have your dealer check for problems.

## **High coolant temperature indicator**

Comes on briefly when the ignition switch is turned to the **I** (On) position.

**If it comes on while riding:**  **P.300**

## **Left turn signal indicator**

## **PGM-FI (Programmed Fuel Injection) malfunction indicator lamp (MIL)**

Comes on briefly when the ignition switch is turned to the **I** (On) position.

**If it comes on or flashes while engine is running:**  **P.302**

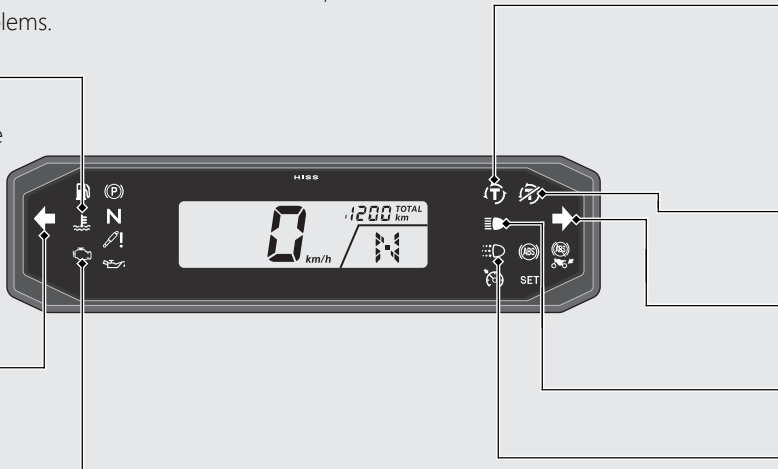

 **Torque Control indicator**

- Comes on when the ignition switch is turned to the **I** (On) position. Goes off when your speed reaches approximately 5 km/h (3 mph) to indicate Torque Control is ready to work.
- Blinks when Torque Control is operating.

**If it comes on while riding:**  **P.304**

 **Torque Control OFF Indicator**

- Comes on when the Torque Control is turned Off.

 **Right turn signal indicator** **High beam indicator** **DRL indicator**  **P.222**

## Indicators *(Continued)*

### **(P) Parking brake indicator**

**CRF1100D/D2/D4**

Lights as a reminder that you have not released the parking brake lever.

### **(N) Neutral indicator**

Comes on when the transmission is in Neutral.



### **Low fuel indicator**

- Comes on briefly when the ignition switch is turned to the **I** (On) position.
- Comes on when there is only reserve fuel left in the fuel tank. Remaining fuel when low fuel indicator comes on:

Approximately 3.6 L (0.95 US gal, 0.79 Imp gal) **(CRF1100A/D)**

Approximately 3.9 L (1.03 US gal, 0.86 Imp gal) **(CRF1100A2/A4/D2/D4)**

**If the indicator comes on and the fuel gauge indicator flashes:  P.306**

 **ABS (Anti-lock Brake System) indicator**

- Comes on briefly when the ignition switch is turned to the **I** (On) position.
- Goes off when your speed reaches approximately 10 km/h (6 mph).

**If it comes on while riding:**  **P.303**

 **Rear ABS (Anti-lock Brake System) OFF Indicator**

- Comes on briefly when the ignition switch is turned to the **I** (On) position.
- Comes on when the ABS function on the rear wheel is turned off.  **P.122**

**SET** **Cruise control SET indicator**

Comes on if you have set a speed for cruise control.

**Cruise Control:**  **P.215**

 **Cruise control main indicator**

Comes on when you press  cruise control main switch.

**Cruise Control:**  **P.215**

## Indicators (Continued)

### **Suspension indicator** CRF1100A4/D4

- Comes on when the suspension initialization is waiting.
- Stop your vehicle and wait for a few seconds until the indicator turns off.

If indicator dose not turn off, contact your dealer.

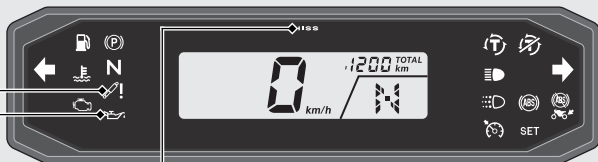

### **Low oil pressure indicator**

- Comes on when the ignition switch is turned to the **I** (On) position.
- Goes off when the engine starts.

**If it comes on while engine is running:**  **P.301**

### **HISS indicator** **P.342**

- Comes on briefly when the ignition switch is turned to the **I** (On) position. Goes off if the ignition key has the correct coding.
- Flashes every 2 seconds for 24 hours when the ignition switch is turned to the **O** (Off) position.





# Switches

**Left handlebar switch** ➔ P.118

**Right handlebar switch** ➔ P.117

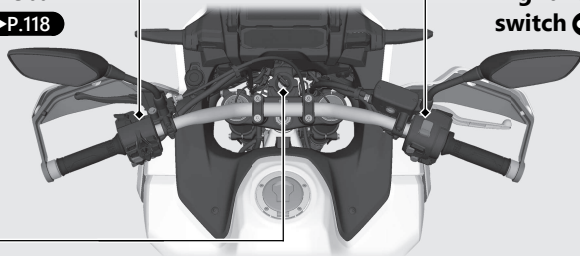

## Ignition switch

Switches the electrical system on/off, locks the steering.

► Key can be removed when in the

○ (Off) or  (Lock) position.

**Steering Lock:** ➔ P.121

**| (On)**

Turns electrical system on for starting/riding.

**○ (Off)**

Turns engine off.

** (Lock)**

Locks steering.

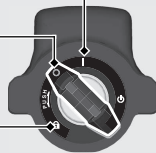

## Right handlebar switch

### Engine stop switch/

#### START button

Should normally remain in the  (Run) position.

- ▶ In an emergency, switch to the  (Stop) position to stop the engine.
- ▶ To start the engine.

 **P.206**

### AT/MT switch

**CRF1100D/D2/D4**

To shift between the AT MODE and MT MODE.

 **P.212**

### Cruise control main switch

Press to activate the cruise control system.  **P.215**

### Function switch

Press to display the pop-up information on the multi-information display.

### N-D switch

**CRF1100D/D2/D4**

To shift between Neutral and AT MODE.  **P.212**

### Cruise control lever

Push up or down to set the speed or adjust the set speed.  **P.217**

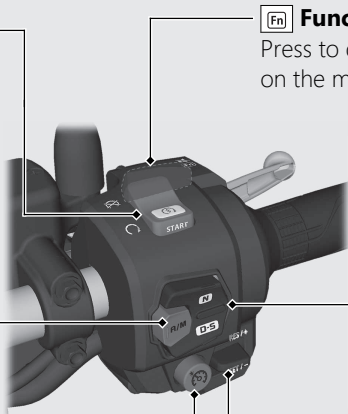

## Switches *(Continued)*

### Left handlebar switch

#### ★ Favourite switch

Favourite switch can be assigned to the HSTC switch, wheelie control switch, riding mode switch or G switch. ➡ **P.88**

#### 📢 Horn button

#### ↔ Turn signal switch

The turn signal will automatically stop when you complete the turn. (You can manually cancel the lights by pressing the switch in.) When used for a lane change, the turn signal will automatically stop in 7 seconds or after riding 120 m (131 yards). In some cases, the timing at which the turn signal stops could be less or more. Always use the recommended tyres to ensure correct automatic cancellation operation.

#### Shift down switch (-)

**CRF1100D/D2/D4**

To shift down the gear. ➡ **P.214**

#### ⚠ Hazard switch

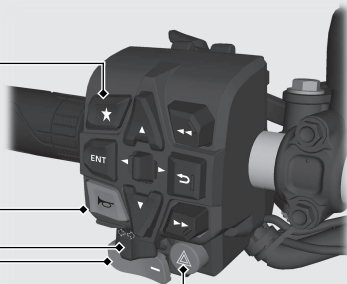

Switchable when the ignition switch is turned to the **I** (On) position. Can be turned to off regardless of the ignition switch position.

- ▶ The signals continue flashing with the ignition switch in **O** (Off) or **I** (Lock) after the hazard switch is on.

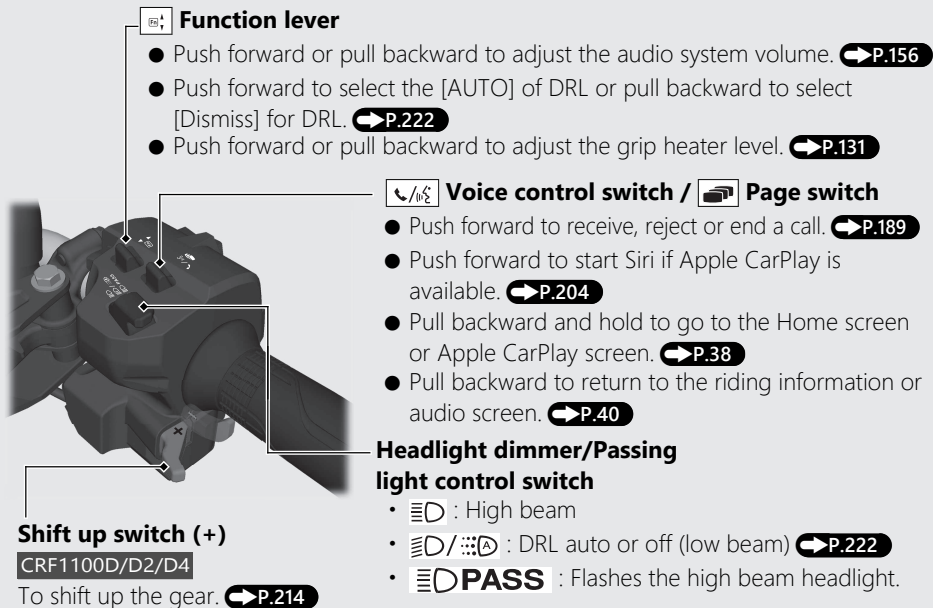











### **Function lever**

- Push forward or pull backward to adjust the audio system volume.  **P.156**
- Push forward to select the [AUTO] of DRL or pull backward to select [Dismiss] for DRL.  **P.222**
- Push forward or pull backward to adjust the grip heater level.  **P.131**

### **Voice control switch /** **Page switch**

- Push forward to receive, reject or end a call.  **P.189**
- Push forward to start Siri if Apple CarPlay is available.  **P.204**
- Pull backward and hold to go to the Home screen or Apple CarPlay screen.  **P.38**
- Pull backward to return to the riding information or audio screen.  **P.40**

### **Headlight dimmer/Passing light control switch**

-  : High beam
-  : DRL auto or off (low beam)  **P.222**
-  **PASS** : Flashes the high beam headlight.

### **Shift up switch (+)**

CRF1100D/D2/D4

To shift up the gear.  **P.214**

## Switches *(Continued)*

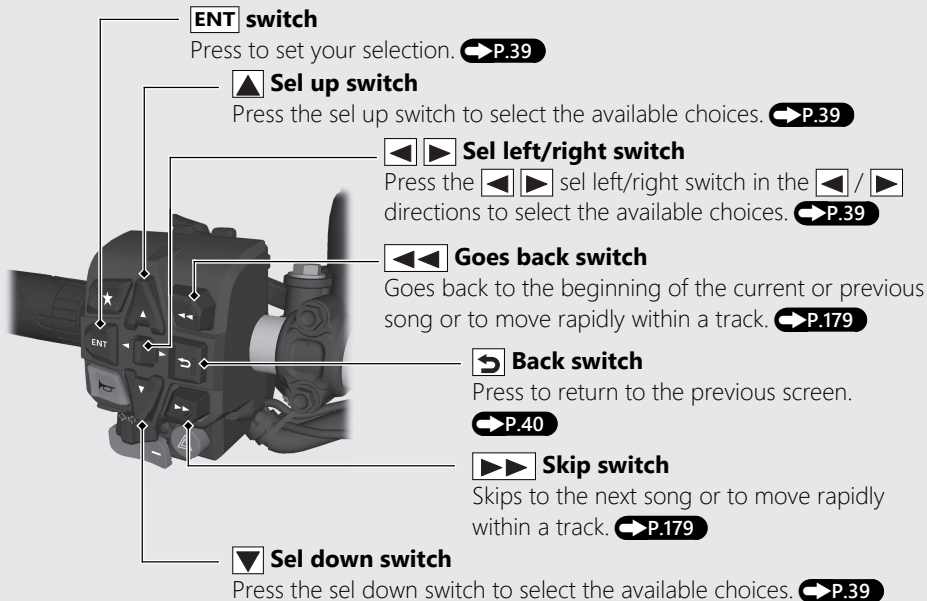

## Steering Lock

Lock the steering when parking to help prevent theft.

A U-shaped wheel lock or similar device is also recommended.

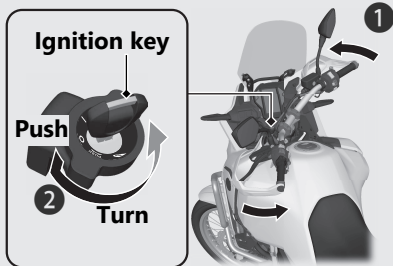

## Locking

- 1 Turn the handlebar all the way to the left.
- 2 Push the key down, and turn the ignition switch to the  (Lock) position.
  - ▶ Jiggle the handlebar if the lock is difficult to engage.
- 3 Remove the key.

## Unlocking

Insert the key, push it in, and turn the ignition switch to the  (Off) position.

# ABS function on the rear wheel

The ABS function on the rear wheel can be optionally turned off for off-road riding. You can turn off the rear wheel ABS function in [OFF ROAD MODE], [USER 1 MODE] or [USER 2 MODE].

- ▶ Each time the ignition switch is turned to the **I** (On) position, the ABS function on both wheels will automatically be turned on [ACTIVE], but the ABS will maintain the rear wheel [CANCEL] off-function when engine stopped by using the engine stop switch.
- ▶ Select [ON ROAD] of ABS mode [ABS], the ABS function on both wheels [ABS RR] will automatically be turned on [ACTIVE].
- ▶ When changing the riding mode, the ABS function on both wheels will automatically be turned on [ACTIVE].

## To turn off the ABS function on the rear wheel



- 1 Stop the vehicle and close the throttle completely.
- 2 Select [OFF ROAD MODE], [USER 1 MODE] or [USER 2 MODE] mode of riding mode.

➡ **P.148**

If [USER 1 MODE] or [USER 2 MODE] is selected, select [OFF ROAD] for ABS mode [ABS]. ➡ **P.76**

- 3 Select the gold image display. ➡ **P.81**
- 4 Select page 4. ➡ **P.45**



- 5 Press the **ENT** switch.
- 6 Select [ABS RR].
- 7 Press  on the  sel left/right switch to select [CANCEL] (off).

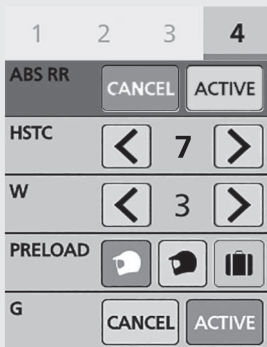

- 8 Read the notice message.
- 9 Select [Yes], and then press the **ENT** switch.

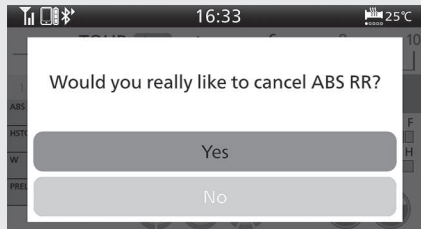

- 10 Press the  back switch.
  - ▶ The rear ABS OFF indicator is on, when the ABS function on the rear wheel [ABS RR] is turned [CANCEL] (off).

You can also perform the above settings by using the touch screen.

## ABS function on the rear wheel *(Continued)*

### To turn on the ABS function on both wheels

- ① Stop the vehicle and close the throttle completely.
- ② Select the gold image display. ➡ P.81
- ③ Select page 4. ➡ P.45

- ④ Press the **ENT** switch.
- ⑤ Select [ABS RR].
- ⑥ Press **▶** on the **◀ ▶** sel left/right switch to select [ACTIVE] (on).
  - ▶ The rear ABS OFF indicator flashes several times, and then off, when the ABS function on the rear wheel [ABS RR] is turned on [ACTIVE].



- 7 Press the  back switch.  
You can also perform the above settings by using the touch screen.

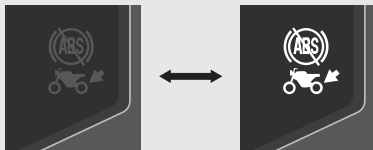

### When the gold image is selected:



**ABS function on both wheels is [ACTIVE] (on).**

**ABS function on rear wheel is [CANCEL] (off).**

**Available settings:** [ACTIVE]/[CANCEL]

**Default:** [ACTIVE]

# G switch

CRF1100D/D2/D4

The G switch can change the engine characteristics of your vehicle to help improve traction and machine control for off-road riding by reducing the amount of clutch slip during throttle operation.

▶ Other than USER 1 and USER 2 MODE

Each time the ignition switch is turned to the **I** (On) position, the G switch [G] will automatically be set to default setting.

USER 1 and USER 2 MODE

The G switch [G] setting will be maintained even if the ignition switch is turned to the **O** (Off) position.

▶ The G switch [G] may not compensate for rough road conditions.

Always consider road and weather conditions, as well as your skills and condition, when applying throttle.

## G switch on or off

- When using the **★** favourite switch.
  - 1 Stop the vehicle and close the throttle completely.
  - 2 Select [G Switch] of the **★** favourite switch. **➡ P.88**
  - 3 Press the **★** favourite switch.

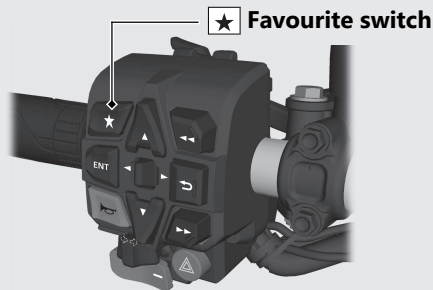

- When using the multi-information display:

- ① Stop the vehicle and close the throttle completely.
- ② Select the gold image display. ➡P.81
- ③ Select page 4. ➡P.45
- ④ Press the **ENT** switch.
- ⑤ Select [G].

- ⑥ Press ◀ on the ◀ ▶ sel left/right switch to select [CANCEL] (off). Press ▶ on the ◀ ▶ sel left/right switch to select [ACTIVE] (on).

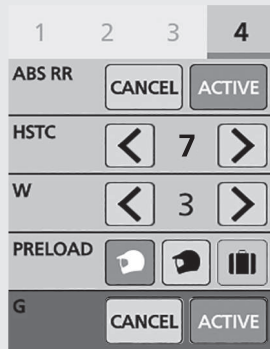

- ⑦ Press the ↶ back switch. You can also perform the above settings by using the touch screen.

## G switch *(Continued)*

When the gold image is selected:

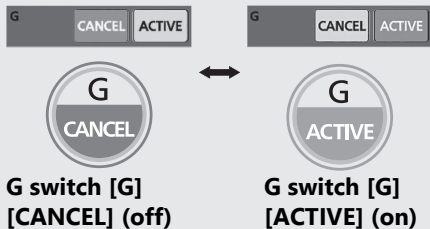

**Available settings:** [ACTIVE]/[CANCEL]

**Default:**

- [TOUR MODE]: [CANCEL]
- [URBAN MODE]: [CANCEL]
- [GRAVEL MODE]: [CANCEL]
- [OFF ROAD MODE]: [ACTIVE]
- [USER 1 MODE]: [CANCEL]
- [USER 2 MODE]: [CANCEL]

# Parking Brake

CRF1100D/D2/D4

## Parking Brake Lever

Be sure the parking brake is applied while parking and warming up the engine.

- ▶ Make sure the parking brake lever is released before riding.

### To apply the parking brake

Squeeze the parking brake lever (①) fully then rotate the lock lever (②) clockwise until it engages the slot on the parking brake lever bracket back to lock the rear wheel.

- ▶ The parking brake lock will not function if the parking brake is not adjusted properly.

➡ P.270

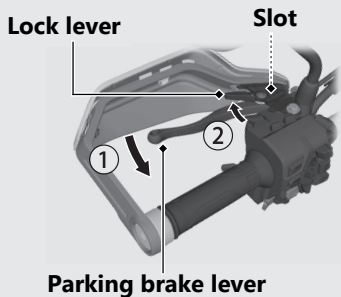

### To release the parking brake

Squeeze the parking brake lever until the lock lever is released from the slot on the parking brake lever bracket.

- ▶ Before riding, check that the parking brake indicator is turned off and make sure that the parking brake is fully released so there is no drag on the rear wheel.

# Handle Grip Heater

CRF1100A2/A4/D2/D4

This vehicle is equipped with a handle grip heater that warms up your hands during ride. Wear gloves to protect your hands from the heated grips.

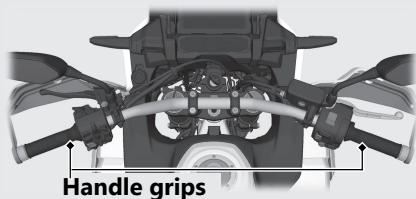

## Handle grip heater indicator:

The selected heater level is indicated by the number of times the indicator blinks when the heater is turned on and the heater level is changed. For example, If you select heater level 5, the indicator blinks 5 times and repeats it 7 times.

## Heater level:

The selected heater level is indicated for a few seconds in the clock area, when the handle grip heater switch is operated.

## Handle grip heater status icon: P.132

Displayed when the handle grip heater is on.



## To operate handle grip heater

- 1 Start the engine. → P.206
- 2 Select the handle grip heater display of pop-up information using the **[Fn]** function switch.

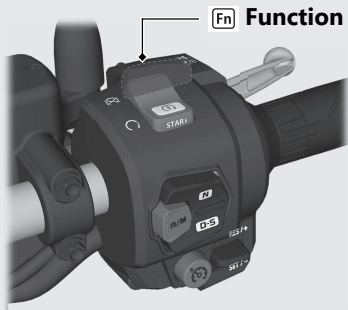

- 3 Push forward or pull backward the **[Fn]** function lever to select the handle grip heater level.

- ▶ The status icon will be appeared on the display when the handle grip heater operates.
- ▶ Do not leave the handle grip heater in the high position for a long time on a warm day.

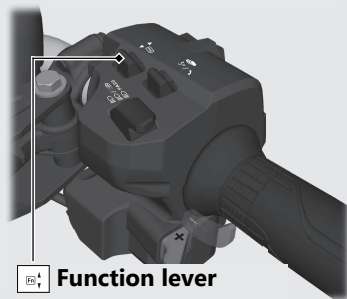

## Handle Grip Heater (Continued)

### To turn off handle grip heater

① Select the handle grip heater display of pop-up information using the **[Fn]** function switch.

② Pull backward the **[Fn]** function lever several times to select the handle grip heater off.

Do not use the handle grip heater with the engine at idle for a long time. It may result in a low (or dead) battery.

Maintains the selected level when the ignition switch is turned to the **○** (Off) position.

► The heater level is not changed if the ignition switch is turned to the **○** (Off) position within 5 seconds after heater level changed.

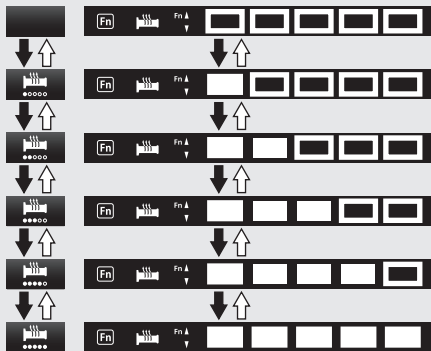

**No indication (Off)**

**Level 1** lowest temperature

**Level 2**

**Level 3**

**Level 4**

**Level 5** highest temperature

**→ Push forward the **[Fn]** function lever**

**← Pull backward the **[Fn]** function lever**

# Honda selectable torque control





Torque Control level (engine power control) can be selected or turned on/off.

- ▶ Do not change the Torque Control level while riding.  
Stop the vehicle first, turn the Torque Control off or on and select the desired level.
- ▶ The Torque Control setting cannot be changed or turned off when the system is activated (Torque Control indicator flashing).





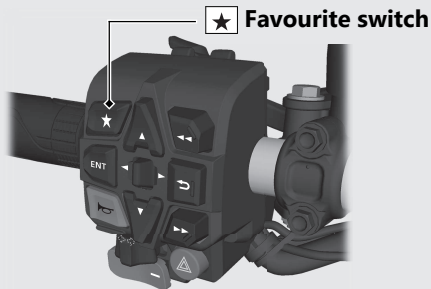

- ▶ In the following cases, the Torque Control will be turned on and the specific Torque Control level will automatically be set as below.
  - Each time the ignition switch is turned to the **I** (On) position, the Torque Control level will automatically be set to level it was set to. However, if the level was set to [0] (off), it will become level 1.
- ▶ When the Torque Control is turned from the [0] (off) position to the on position, it will automatically be set to level of before turning off the Torque Control.

## Honda selectable torque control *(Continued)*

### Torque Control level setting

- When using the  favourite switch:
  - 1 Stop the vehicle.
  - 2 Select the [HSTC] of the  favourite switch.  P.88
  - 3 Press the  favourite switch.
    - ▶ 7: the maximum Torque Control level
    - ▶ 1: the minimum Torque Control level











- When using the multi-information display:
  - 1 Stop the vehicle.
  - 2 Select the gold image display.  P.81
  - 3 Select page 4.  P.45
  - 4 Press the **ENT** switch.
  - 5 Select [HSTC].
  - 6 Push the  or  of the   sel left/right switch to select your preferred level.



7 Press the  back switch.

You can also perform the above settings by using the touch screen.

### Torque Control on and off

- 1 Stop the vehicle.
- 2 Select the gold image display.  P.81
- 3 Select page 4.  P.45
- 4 Press the **ENT** switch.
- 5 Select [HSTC].
- 6 Press and hold  on the   sel left/right switch to set the [0] (off).  
Press and hold  on the   sel left/right switch to set to level of before turning [0] (off) the Torque Control.



7 Press the  back switch.

You can also perform the above settings by using the touch screen.

**Setting range:** Level 1 to 7 or 0 (Off)

## Honda selectable torque control *(Continued)*

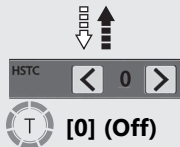
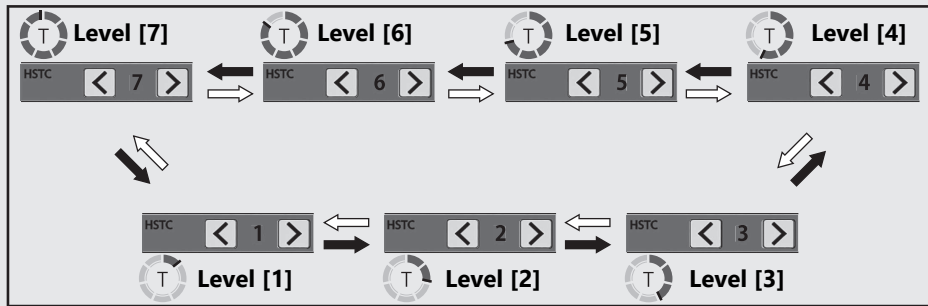

- Push on the sel left/right switch
- Push on the sel left/right switch or press the favourite switch
- Push and hold on the sel left/right switch
- Push and hold on the sel left/right switch



# Wheelie Control



Wheelie Control level [W] can be selected or turned on/off.

- ▶ Do not change the wheelie control level [W] while riding.  
Stop the vehicle first, then select the wheelie control level [W].





- ▶ In the following cases, the wheelie control [W] will be turned on and the specific wheelie control level [W] will automatically be set as below.
  - Each time the ignition switch is turned to the **I** (On) position, the wheelie control level [W] will automatically be set to level it was set to. However, if the level was set to 0 (off), it will automatically be set to level of before turning off the wheelie control level [W].
- ▶ When the wheelie control [W] is turned from the [0] (off) position to the on position, it will automatically be set to level of before turning off the wheelie control [W].

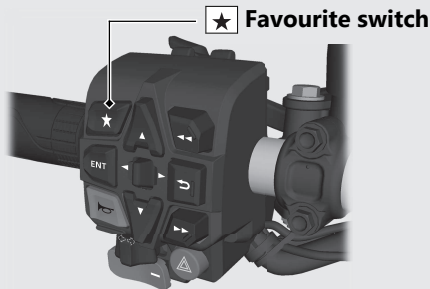

## Wheelie Control Level setting

- When using the  favourite switch:
  - 1 Stop the vehicle.
  - 2 Select the [W] of the  favourite switch. **➔P.88**
  - 3 Press the  favourite switch.
    - ▶ 3: the maximum wheelie control level [W]
    - ▶ 1: the minimum wheelie control level [W]



- When using the multi-information display:
  - 1 Stop the vehicle.
  - 2 Select the gold image display. **➔P.81**
  - 3 Select page 4. **➔P.45**
  - 4 Press the **ENT** switch.
  - 5 Select [W].
  - 6 Push the  or  of the   sel left/right switch to select your preferred level.



## Wheelie Control *(Continued)*

7 Press the  back switch.

You can also perform the above settings by using the touch screen.

### Wheelie Control on and off

1 Stop the vehicle.



2 Select the gold image display.  P.81

3 Select page 4.  P.45

4 Press the **ENT** switch.

5 Select [W].

6 Press and hold  on the   sel left/right switch to set the [0] (off).

Press and hold  on the   sel left/right switch to set to level of before turning [0] (off) the wheelie control.

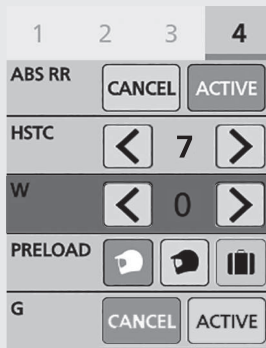







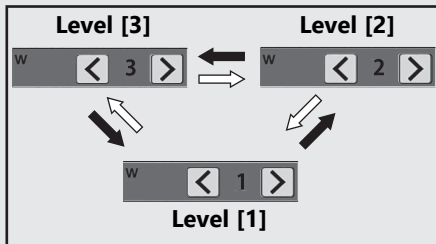









7 Press the  back switch.

You can also perform the above settings by using the touch screen.

**Setting range:** Level 1 to 3 or 0 (Off)



[0] (Off)

-  Push  on the   sel left/right switch
-  Push  on the   sel left/right switch or press the  favourite switch
-  Push and hold  on the   sel left/right switch
-  Push and hold  on the   sel left/right switch

# Riding mode

You can change the riding mode.

The riding mode consists of the following parameters.

[P] Power: Engine output level

[EB] Engine brake: Engine brake level

## CRF1100A4/D4

[S] [Overall]: Suspension damping

[Front]: Suspension damping

[Rear]: Suspension damping

## CRF1100D/D2/D4

[G] G switch:  **P.126**

[ABS] ABS mode:

- [OFF ROAD]: Off road mode
- [ON ROAD]: On road mode

## CRF1100A4/D4

[PRELOAD] [Preload]: Rear suspension preload

- (Rider): Rider only (Minimum preload)
- (Rider+Cargo): Rider and luggage
- (Rider+Passenger): Rider and passenger
- (Rider+Passenger+Cargo): Rider, passenger and luggage (Maximum preload)

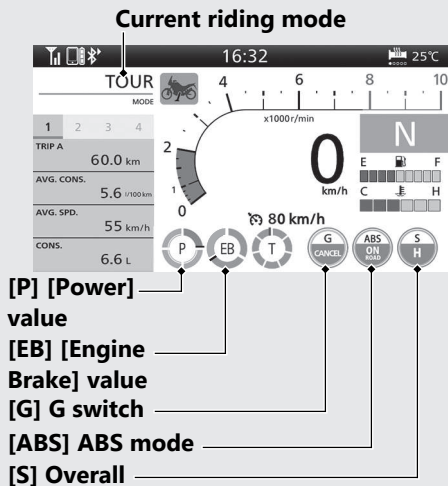

Riding mode has 6 modes.

Available riding modes: [TOUR MODE], [URBAN MODE], [GRAVEL MODE], [OFF ROAD MODE], [USER 1 MODE] and [USER 2 MODE]

[TOUR MODE], [URBAN MODE], [GRAVEL MODE] and [OFF ROAD MODE]

- ▶ **[TOUR MODE]**: Enables smooth acceleration even when riding with a passenger or a full load of luggage.
- ▶ **[URBAN MODE]**: Standard, all-round mode for a variety of situations.
- ▶ **[GRAVEL MODE]**: Good for stable riding on slippery surfaces such as dirt roads.
- ▶ **[OFF ROAD MODE]**: Suitable for enjoying off-road sports riding.

Each initial setting value cannot be changed.

**[USER 1 MODE]** and **[USER 2 MODE]**

Each initial setting value can be changed.

## Riding mode *(Continued)*

### Initial setting

Riding modes	[P] [Power] value	[EB] [Engine Brake] value	Suspension damping			[ABS] ABS mode	[G] G switch *2
			[S] [Overall] *1	[Front] *1	[Rear] *1		
[TOUR MODE]	1	2	H	STD	STD	ON ROAD	CANCEL*3
[URBAN MODE]	2	2	M	STD	STD	ON ROAD	CANCEL*3
[GRAVEL MODE]	4	3	S	STD	STD	OFF ROAD	CANCEL*3
[OFF ROAD MODE]	3	3	O	STD	STD	OFF ROAD	ACTIVE*3
[USER 1 MODE]	2*3	2*3	M*3	STD*3	STD*3	ON ROAD*3	CANCEL*3
[USER 2 MODE]	4*3	3*3	S*3	STD*3	STD*3	OFF ROAD*3	CANCEL*3

Notes:

\*1 : CRF1100A4/D4

\*2 : CRF1100D/D2/D4

\*3 : Value can be changed.

<b>Riding modes</b>	<b>[PRELOAD] [Preload] (Rider) <sup>*1</sup></b>	<b>[PRELOAD] [Preload] (Rider+ Cargo) <sup>*1</sup></b>	<b>[PRELOAD] [Preload] (Rider+ Passenger) <sup>*1</sup></b>	<b>[PRELOAD] [Preload] (Rider+ Passenger+ Cargo) <sup>*1</sup></b>
[TOUR MODE]	5	10	15	20
[URBAN MODE]	5	10	15	20
[GRAVEL MODE]	5	10	15	20
[OFF ROAD MODE]	5	10	15	20
[USER 1 MODE]	5 <sup>*2</sup>	10 <sup>*2</sup>	15 <sup>*2</sup>	20 <sup>*2</sup>
[USER 2 MODE]	5 <sup>*2</sup>	10 <sup>*2</sup>	15 <sup>*2</sup>	20 <sup>*2</sup>

Notes:

\*1 : CRF1100A4/D4

\*2 : Value can be changed.

## Riding mode *(Continued)*

### [P] Power value (Engine output level)

[P] Power value has four setting levels.

Available setting range: 1 to 4

- ▶ Level 1 has the maximum power.
- ▶ Level 4 has the minimum power.

### [EB] Engine brake value (Engine brake level)

EB value has three setting levels.

Available setting range: 1 to 3

- ▶ Level 1 has the strongest engine braking effect.
- ▶ Level 3 has the weakest engine braking effect.

### [S] Overall: suspension damping

**CRF1100A4/D4**

[S] Overall value has four setting levels.

Available setting range: [H] Hard / [M] Medium / [S] Soft / [O] Off Road

- ▶ [H] Hard has the maximum suspension damping.
- ▶ [S] Soft has the minimum suspension damping.
- ▶ [O] Off Road is for off road settings.

### [Front]: suspension damping

**CRF1100A4/D4**

[Front] has three setting levels.

Available setting range: - / STD / +

- ▶ + has the maximum suspension damping.
- ▶ - has the minimum suspension damping.



**[Rear]: suspension damping****CRF1100A4/D4**

[Rear] has three setting levels.

Available setting range: - / STD / +

- ▶ + has the maximum suspension damping.
- ▶ - has the minimum suspension damping.

**ABS mode [ABS]**

ABS mode [ABS] has two setting levels.

Available setting range: [OFF ROAD] or [ON ROAD]

- ▶ [OFF ROAD] is for off road settings.
- ▶ [ON ROAD] is for on road settings.

**[G] G switch** ➡ **P.126****[PRELOAD] [Preload] (Rider), (Rider +Cargo), (Rider+Passenger) and (Rider +Passenger+Cargo): rear suspension preload****CRF1100A4/D4**

[PRELOAD] [Preload] Preload has twenty four setting levels.

Available setting range: 1 to 24

- ▶ Level 24 has the maximum suspension preload.
- ▶ Level 1 has the minimum suspension preload.

## Riding mode *(Continued)*

### Selecting the riding mode

When change the riding mode, the rear wheel ABS function [ABS RR] will automatically be set to [ACTIVE].

- When using the ▲ sel up switch and ▼ sel down switch:
  - 1 Press the ▲ sel up switch or ▼ sel down switch.

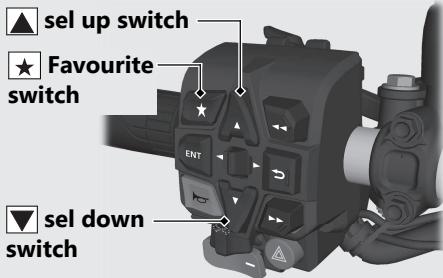

You can also perform the above settings by using the touch screen.

- When using the ★ favourite switch:
  - 1 Select the [Riding Mode] of the ★ favourite switch. ➔ P.88
  - 2 Press the ★ favourite switch.

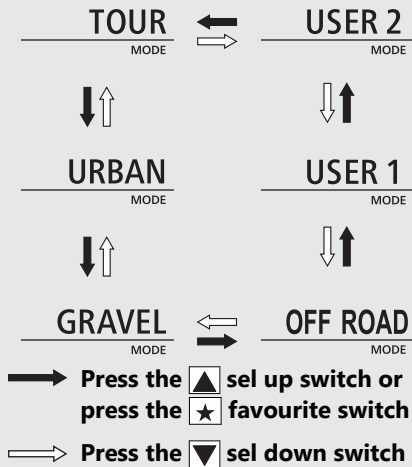

## Setting the riding mode

You can change the [P] [Power], [EB] [Engine Brake], [S] [Overall], [Front], [Rear], ABS mode [ABS] and [PRELOAD] [Preload] on the [USER 1 MODE] and [USER 2 MODE] of the riding mode.  **P.76**

# Audio System

## About Your Audio System

This audio system can play audio files on *Bluetooth*® audio devices (mobile phone, digital audio player or equivalents).

The audio system can pair with *Bluetooth*® sound devices (speakers, headsets, communication devices or equivalents).

You can operate the audio system from the switches on the left handlebar and multi-information display. However, you cannot operate some functions by the touch screen while the vehicle is in motion.

- Local laws may prohibit the operation of handheld electronic devices while operating a vehicle.
- Only operate audio switches when safe to do so.

- Set the volume at a level that still allows horns and emergency vehicles to be heard.
- Some audio devices, iPhone and *Bluetooth*® sound devices may not be compatible.
- We shall not be liable for any damages or trouble in the use of audio device.
- iPhone, iPad, iPad Air, iPad Mini, iPod, iPod touch, iPod classic, iPod shuffle and iPod nano are trademarks of Apple Inc.

## About *Bluetooth*® audio

- Only one *Bluetooth*® audio device and two *Bluetooth*® sound devices can be paired with the audio system at a time. When another device is paired, the information on the previously registered device is cancelled.
- If you receive a call to a paired phone while playing an audio, the paired phone may stop playing.
- When unable to connect your *Bluetooth*® device to the audio system or when sounds skip or noises mix while playing, change the storage location of the *Bluetooth*® device.

## *Bluetooth*® Wireless Technology

The *Bluetooth*® word mark and logos are registered trademarks owned by Bluetooth SIG, Inc., and any use of such marks by Honda Motors Co., Ltd., is under license. Other trademarks and trade names are those of their respective owners.

## Audio System *(Continued)*

### Audio System Location

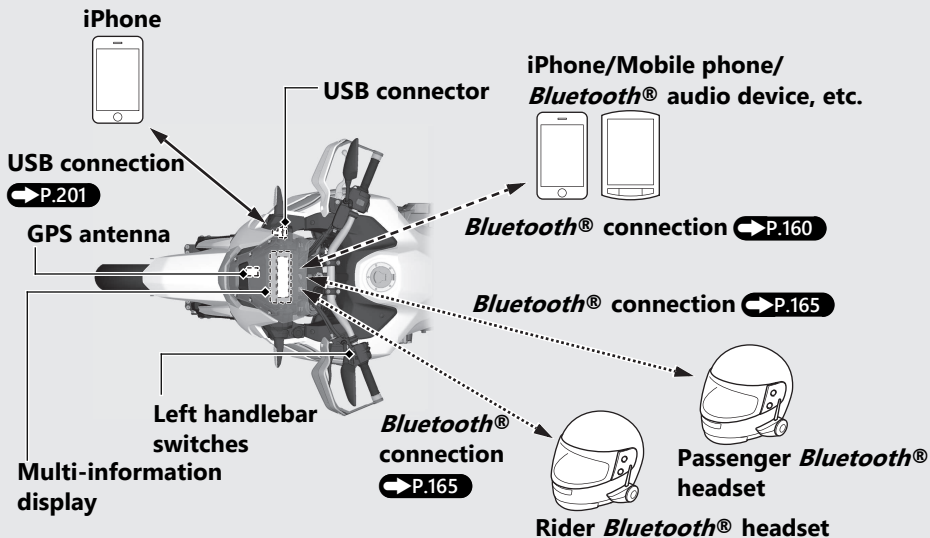

 **USB connection for Apple CarPlay** **Audio system supported profiles:**

- HFP ver. 1.5
- A2DP ver. 1.2
- AVRCP ver. 1.4
- PBAP ver. 1.0

 **Headset supported profiles:**

- HFP ver. 1.7
- A2DP ver. 1.2







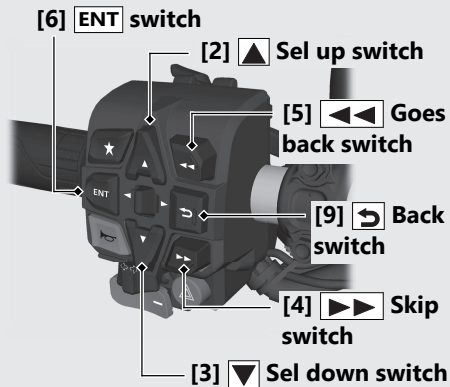
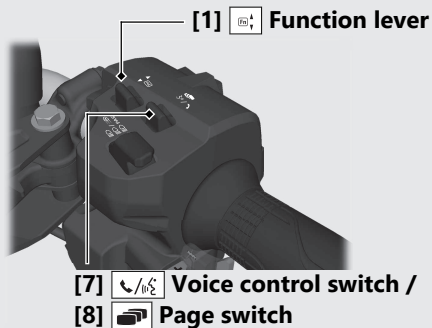

## Audio System *(Continued)*

### Basic Operations

You can operate and set the various functions of the audio system using the touch screen and/or switches on the left handlebar. However, you cannot operate some functions by the touch screen while the vehicle is in motion.





- [1]  Function lever: Push forward or pull backward the lever to adjust the volume.
- To increase the volume: Push forward the lever.
  - To decrease the volume: Pull backward the lever.
  - To increase the volume rapidly: Push forward and hold the lever.
  - To decrease the volume rapidly: Pull backward and hold the lever.
- [2]  Sel up switch: Press the switch to select a menu item.
- [3]  Sel down switch: Press the switch to select a menu item.
- [4]  Skip switch:
- To skip to the next song: Press the switch.
  - To move rapidly within a track: Press and hold the switch.
- [5]  Goes back switch:
- To go back to the beginning of the current or previous song: Press the switch.
  - To move rapidly within a track: Press and hold the switch
- [6]  ENT switch: Press to set your selection.
- [7]  Voice control switch:
- To receive or end a call. Starts Siri if Apple CarPlay is available: Push forward the switch.
  - To reject a call: Push forward and hold the switch.
- [8]  Page switch:
- To return to the riding information or audio screen: Pull backward the switch.
  - To return to the home screen or Apple CarPlay screen: Pull backward and hold the switch.
- [9]  Back switch:
- To return to the previous screen: Press the switch.
  - To return to the audio screen: Press and hold the switch.

## Audio System *(Continued)*

### To Adjust the Volume

You can adjust the volume settings for the headsets.

The system has the following unique volume levels.

Adjust the volume while in the individual modes.

- [Music]
- [Phone]
- [System]
- [Ringtone]
- [Voice]
- [CarPlay]
- [Microphone]

Each volume can also be set from the menu.

➔ P.95

When you push forward or pull backward the  function lever, the volume control level appears on the pop-up information.

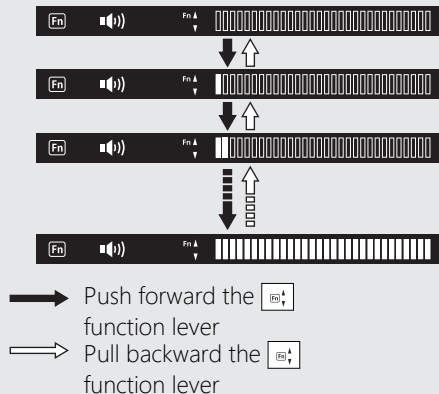

To increase the volume: push forward the  function lever.

- ▶ To increase the volume rapidly, push forward and hold the  function lever.

To decrease the volume: pull backward the  function lever.

- ▶ To decrease the volume rapidly, pull backward and hold the  function lever.

### Volume level range:

Other than Micro phone: Level 0 to 30  
Microphone: Level 0 to 14

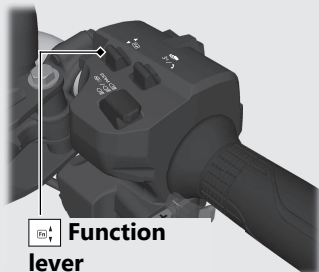

### Automatic Volume

Selects the volume setting to automatically increase volume from the headsets as the speed of the vehicle increases.

#### To select the Automatic Volume:

 P.95

**Available settings:** [Off]/[Low]/[High]

**Default:** [Off]

## Audio System *(Continued)*

### **Bluetooth® Audio**

#### **Bluetooth® Setting**

You can connect with your *Bluetooth*® audio device (mobile phone, digital audio player or equivalents) and *Bluetooth*® headsets via *Bluetooth*®.

Available devices are as follows:

- [Phone Pairing] (For *Bluetooth*® audio device) ➔ **P.160**
- [Headset Pairing] (For rider headset and passenger headset) ➔ **P.165**

## Supported *Bluetooth*® version/profiles

<i>Bluetooth</i> ® version	Bluetooth 2.1 + EDR
<i>Bluetooth</i> ® profiles (For iPhone, mobile phone or <i>Bluetooth</i> ® device)	HFP (Hand Free Profile) ver. 1.5
	A2DP (Advanced Audio Distribution Profile) ver. 1.2
	AVRCP (Audio/Video Remote Control Profile) ver. 1.4
	PBAP (Phone Book Access Profile) ver. 1.0
<i>Bluetooth</i> ® profiles (For rider and passenger headsets)	HFP (Hand Free Profile) ver. 1.7
	A2DP (Advanced Audio Distribution Profile) ver. 1.2

- You cannot pair a *Bluetooth*® device and *Bluetooth*® headsets while the vehicle is moving. When pairing, park your vehicle in a safe place.
- *Bluetooth*® connection cannot be established while launching Apple CarPlay.
- Your vehicle is not equipped with intercom function. If you want to use the intercom function, use the intercom function of your headset.
- Some local governments prohibit the use of a headset by the operator of a motor vehicle. Always obey applicable laws and regulations.

## Audio System *(Continued)*

### Phone Pairing

You can establish a *Bluetooth*® connection in two ways.

- [Visible]: Search from the device.
- [Phone Pairing]: Search from the system.

This function is disabled while the vehicle is in motion.

1 Enable the *Bluetooth*® function on your device.

▶ For details, refer to the instruction manual of your device.

2 Select [Bluetooth], and then press the **ENT** switch.

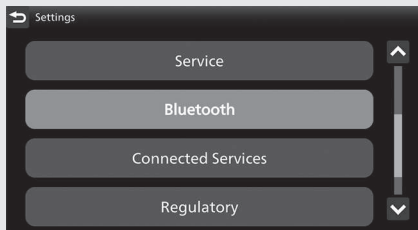

- 3 Select [Bluetooth], and then press the **ENT** switch to [ON] (enable) the function.

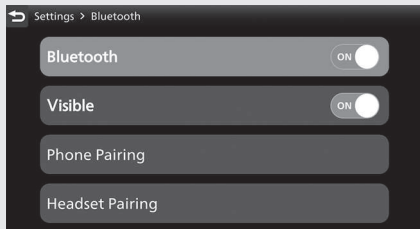

### [Visible]

- 4 Select [Visible], and then press the **ENT** switch to [ON] (enable) the function.

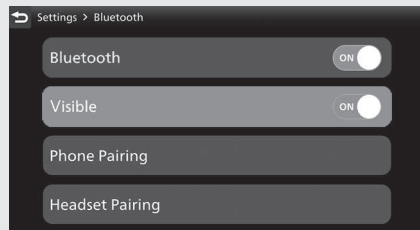

- 5 Tap "Honda Motorcycle #\*\*\*\*\*" on the *Bluetooth*® setting menu of the target device.
  - ▶ The part of \*\*\*\*\* is different letter for each vehicle.
- 6 When a request message appears on the target device, tap "Pair."

## Audio System *(Continued)*

- 7 The device name and Pass Key appear on the screen. Select [Yes], and then press the **ENT** switch.

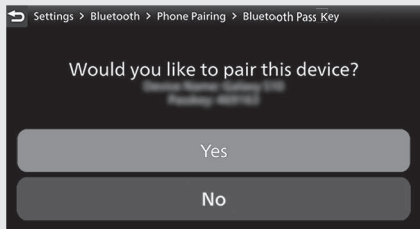

- 8 When the pairing is complete, the name of the paired device are displayed.  
Icon status:

 : Phone function connected

 : Music function connected

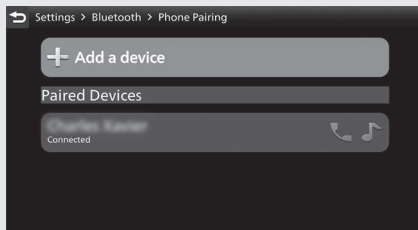

- 9 Return to the riding information, previous screen or Home screen. **➡ P.40**  
You can also perform the above settings by using the touch screen.



## [Phone Pairing]

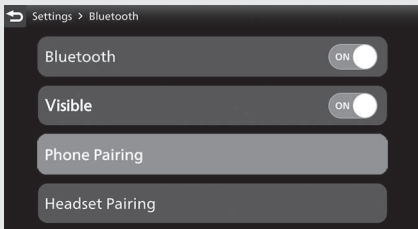

- 4 Select [Phone Pairing], and then press the **ENT** switch.

- 5 Select [+Add a device], and then press the **ENT** switch.

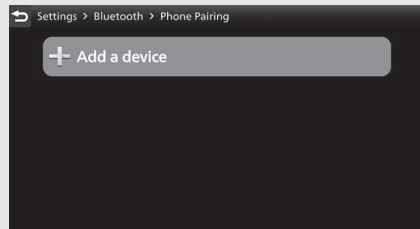

- 6 The names of the detected device are displayed.
- ▶ If many *Bluetooth*® devices are detected, the target device may be detected under the list, scroll down the list.

## Audio System *(Continued)*

- 7 Select a target device name, and then press the **ENT** switch.

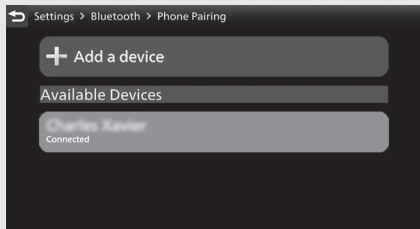

- 8 Select [Yes], and then press the **ENT** switch.

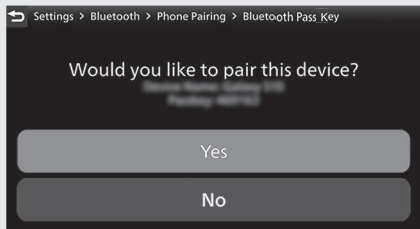

- 9 When a request message appears on the target device, tap "Pair."
- 10 When the pairing is complete, the name of the paired device are displayed. Icon status:

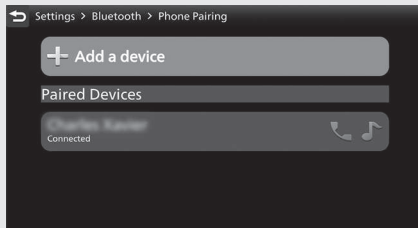
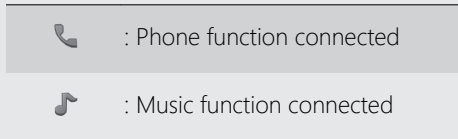

- 11 Return to the riding information, previous screen or Home screen. **➡ P.40**

You can also perform the above settings by using the touch screen.

**To disconnect the phone:** → P.168

## Headset Pairing

This function is disabled while the vehicle is in motion.

- 1 Enable the *Bluetooth*® function on your device.
  - ▶ For details, refer to the instruction manual of your device.
- 2 Select [Bluetooth], and then press the **ENT** switch.

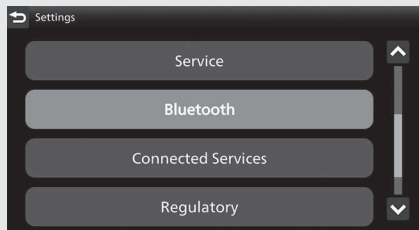

## Audio System *(Continued)*

- 3 Select [Bluetooth], and then press the **ENT** switch to [ON] (enable) the function.

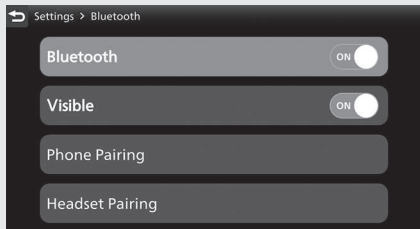

- 4 Select [Headset Pairing], and then press the **ENT** switch.

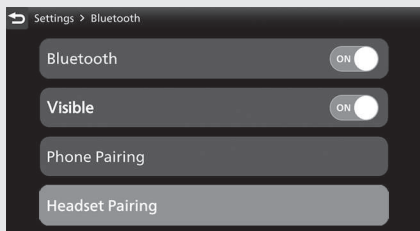

- 5 Select [+ Add a device], and then press the **ENT** switch.

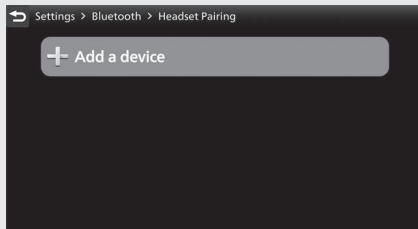

- 6 The names of the detected device are displayed.
- ▶ If many *Bluetooth*® devices are detected, the target device may be detected under the list, scroll down the list.

- 7 Select a target device name, and then press the **ENT** switch.

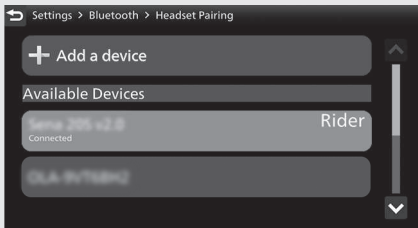

- 8 When the pairing is complete, a message to inform you that pairing was successful appears on the screen.

Rider	When pairing rider headset
Passenger	When pairing passenger headset

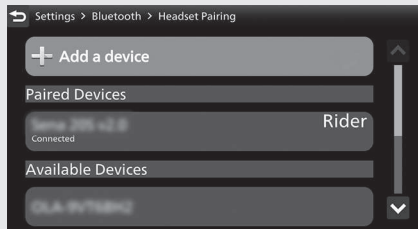

- 9 Return to the riding information, previous screen or Home screen. ➡ **P.40**

You can also perform the above settings by using the touch screen.

**To disconnect the headset:** ➡ **P.168**

## Audio System *(Continued)*

### To Reconnect a Paired Device Automatically

When the ignition switch is turned **I** (On) position, the system reconnects with registered devices automatically.

- ▶ If the system finds multiple paired devices, the system will reconnect with the device that was connected last.
- ▶ After reconnecting, the song that was last played will be played automatically.

### To Connect/Disconnect Available Functions Individually

Depending on the connected device, this function may not be able to establish a connection.

- 1 Select [Bluetooth], and then press the **ENT** switch.

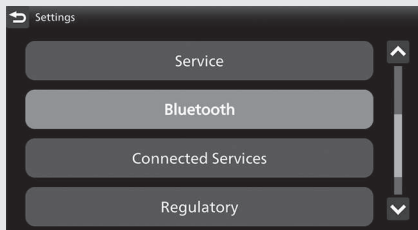

To connect functions:

- 2 [Phone Pairing]
  1. Select [Phone Pairing], and then press the **ENT** switch to enter the setting menu.

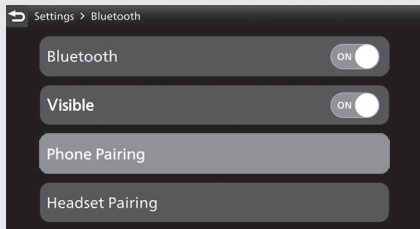

2. Select the paired device, and then press the **ENT** switch.

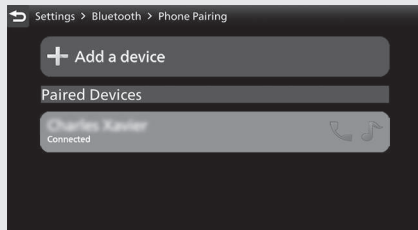

## Audio System *(Continued)*

3. Select [Connect a Phone] or [Connect Music], and then press the **ENT** switch to [ON] (enable) the function.

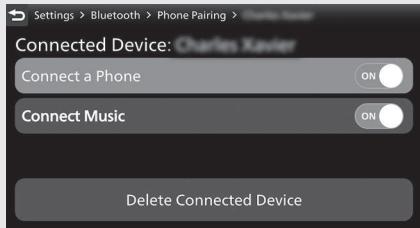

## 2 [Headset Pairing]

1. Select [Headset Pairing], and then press the **ENT** switch to enter the setting menu.





2. Select the paired device, and then press the **ENT** switch.

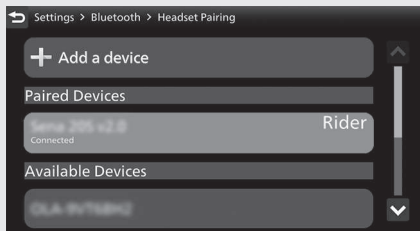

3. Select [Designate as a Rider] or [Connect Headset], and then press the **ENT** switch to [ON] (enable) the function.

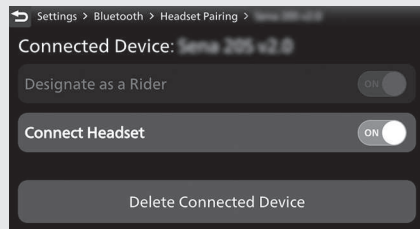

- 3 Return to the riding information, previous screen or Home screen. **➡ P.40**  
You can also perform the above settings by using the touch screen.

## Audio System *(Continued)*

To disconnect functions:

- 2 [Phone Pairing]
  1. Select [Phone Pairing], and then press the **ENT** switch to enter the setting menu.

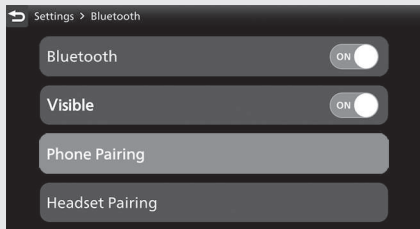

2. Select the paired device, and then press the **ENT** switch.

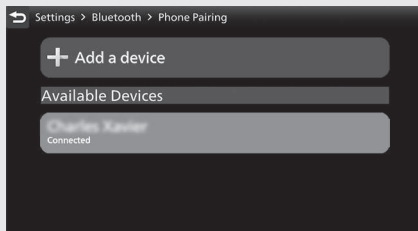

3. Select [Connect a Phone] or [Connect Music], and then press the **ENT** switch to [OFF] (disable) the function.

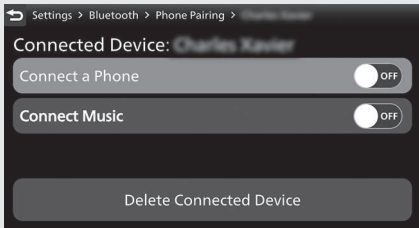

- 2 [Headset Pairing]
  1. Select [Headset Pairing], and then press the **ENT** switch to enter the setting menu.



## Audio System *(Continued)*

2. Select the paired device, and then press the **ENT** switch.

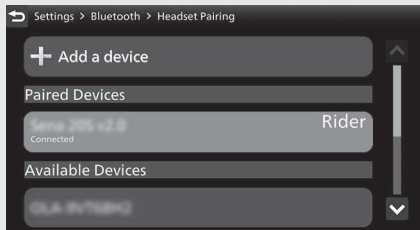

3. Select [Designate as a Rider] or [Connect Headset], and then press the **ENT** switch to [OFF] (disable) the function.

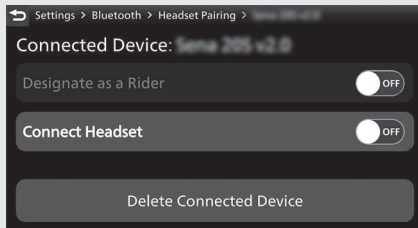

- 3 Return to the riding information, previous screen or Home screen. **➡ P.40**

You can also perform the above settings by using the touch screen.

## To Delete Connected Device

- 1 Select [Bluetooth], and then press the **ENT** switch.

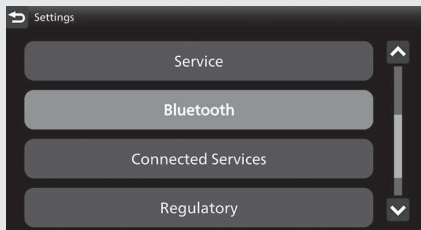

- 2 Select [Phone Pairing] or [Headset Pairing], and then press the **ENT** switch to enter the setting menu.

- 3 Select the paired device, and then press the **ENT** switch.

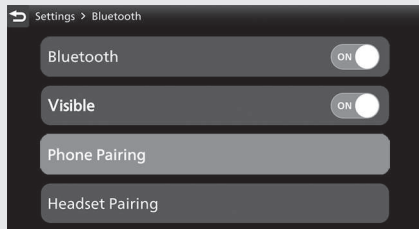

- 4 Select [Delete Connected Device], and then press the **ENT** switch.

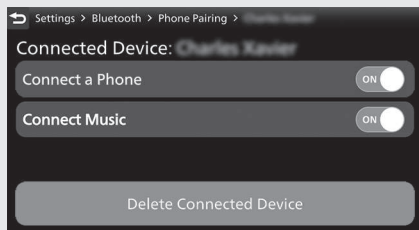

## Audio System (Continued)

- 5 The name of the device disappears from the screen.

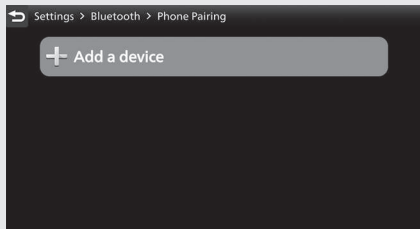

- 6 Return to the riding information, previous screen or Home screen. ➡ P.40

You can also perform the above settings by using the touch screen.

## Playing Audio

The audio system can play music stored on a device connected via *Bluetooth*®.

### [3] Album title

#### [2] Artist name

#### [1] Song title

#### [5] Progress bar

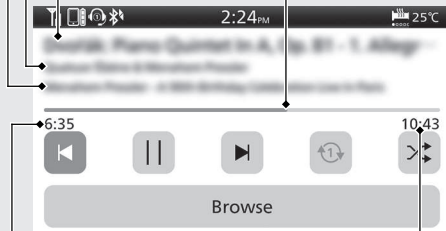

#### [4] Play time

#### [6] Total time

## Screen Information

The information displayed on the screen differs depending on the connected device and the type of file being played back. The system supports ID3 tag information. If a track does not have an ID3 tag, the song title or file name is displayed.

- [1] Song title
- [2] Artist name
- [3] Album title (Folder name)
- [4] Play time
- [5] Progress bar
- [6] Total time

## To Play a Track

- 1 Connect the device you want to play from.  
**Bluetooth® setting:**  **P.168**
- 2 Select [Media], and then press the **ENT** switch.

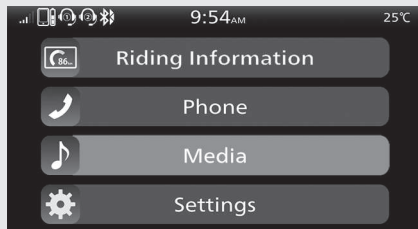

## Audio System *(Continued)*

- 3 Select , and then press the **ENT** switch.

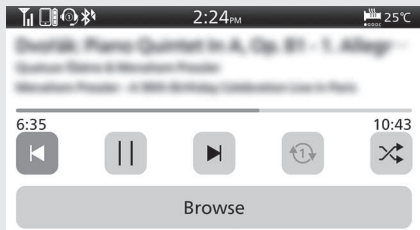

- 4 Return to the riding information, previous screen or Home screen.  **P.40**





You can also perform the above settings by using the touch screen.

## To Pause a Track

Select , and then press the **ENT** switch. You can also perform the above settings by using the touch screen.



## To Change a Track

- To skip to the next song: Press the  skip switch.
- To move rapidly within a track: Press and hold the  skip switch.
- To go back to the beginning of the current or previous song: Press the  goes back switch.
- To move rapidly within a track: Press and hold the  goes back switch.

You can also perform the above settings by using the touch screen.

## To Select the Play Mode

You can select repeat and random modes. The audio play mode status icon or colour of the audio play mode status icon changes.

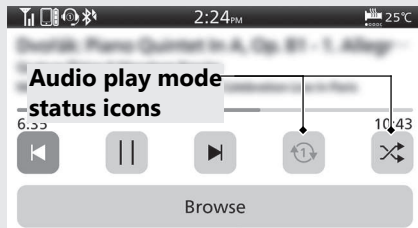

## Audio System *(Continued)*

Cycles through the play modes as follows:

Select , and then press the **ENT** switch.



(Black) No repeat mode: No repeat.



(Blue) Album repeat play mode: Repeats all tracks in the current playlist ([Artists], [Albums] or [Songs], etc.).



(Blue) Track repeat play mode: Repeats the current track.

Select , and then press the **ENT** switch.



(Black) Normal play mode: Plays tracks in original order.



(Blue) Random play mode: Plays tracks randomly.

---

You can also perform the above settings by using the touch screen.

## Handsfree Calling

### Using *Bluetooth*® Handsfree Calling

*Bluetooth*® handsfree calling allows you to make and receive phone calls using your vehicle's audio system, without handling your mobile phone.

To use the handsfree calling, you need a *Bluetooth*® compatible mobile phone and *Bluetooth*® headsets.

- You cannot operate the handsfree calling functions by the touch screen while the vehicle is in motion.
- If *Bluetooth*® connection is unstable due to surrounding conditions or radio wave conditions, the handsfree calling functions may not be available.

- While talking, you may be hard to hear due to wind noise during running or external noise. In that case, try to change the position of the microphone or to adjust the windscreen height

(CRF1100A2/A4/D2/D4).  P.296

## Audio System *(Continued)*

### Preparation

- 1 Connect with the paired mobile phone. **➡ P.160**
  - ▶ The phonebook is updated after every connection. Call history is updated after every connection or call.
- 2 Connect the paired rider headset. **➡ P.165**
- 3 Select [Phone], and then press the **ENT** switch.

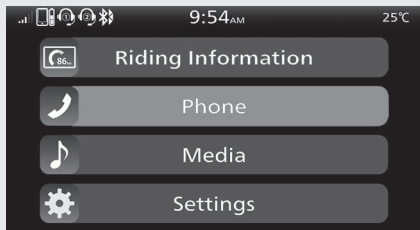

- 4 Return to the riding information, previous screen or Home screen. **➡ P.40**  
You can also perform the above settings by using the touch screen.

### Making a Call

You can make calls by inputting a phone number or by using the phonebook, call history or speed dial entries.

To change the call mode, push **◀** or **▶** on the **◀ ▶** sel left/right switch.

Changes the call modes as follows:

[Call History] ⇄ [Speed Dial] ⇄ [Contacts]  
⇄ [Dial Number] ⇄ [Settings]

- Certain manual functions are disabled while the vehicle is in motion. You cannot select a greyed-out option until the vehicle is stopped.
- Only previously stored speed dial entries and call history can be called while the vehicle is in motion.

**To adjust the phone volume:** **➡ P.95**

## To Make a Call Using the Call History [Call History]

You can make a call using the call history while the vehicle is in motion.

Call history displays the last 30 dialed, received, or missed calls.

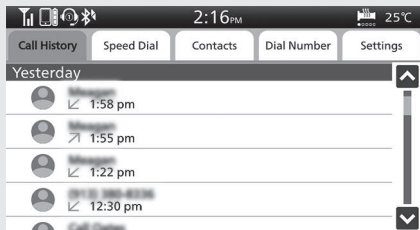



- 1 Select [Call History].
- 2 Select the phone number you want to call, and then press the **ENT** switch.

 (blue): Dialed call

 (blue): Received call

 (red): Missed call

- 3 To end the call, push forward the  voice control switch on the left handlebar.
  - ▶ The same action can be done by selecting [End Call] on the screen.
- 4 Return to the riding information, previous screen or Home screen.  **P.40**

You can also perform the above settings by using the touch screen.

## Audio System *(Continued)*

### To Make a Call Using a Speed Dial Entry [Speed Dial]

You can make a call using the speed dial while the vehicle is in motion.

To make a call using the speed dial, you need to store the speed dial number in advance. ➡ **P.187**

Up to 20 speed dial numbers can be stored.

- 1 Select [Speed Dial].
- 2 Select a person you want to call, and then press the **ENT** switch.  
Dialling starts automatically.

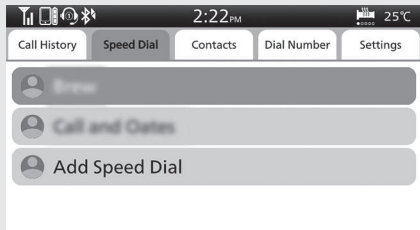

- 3 To end the call, push forward the  voice control switch on the left handlebar.
  - ▶ The same action can be done by selecting [End Call] on the screen.
- 4 Return to the riding information, previous screen or Home screen. ➡ **P.40**

You can also perform the above settings by using the touch screen.

## To Make a Call Using the Phonebook [Contacts]

This function is disabled while the vehicle is in motion.

- 1 Stop the vehicle.
- 2 Select [Contacts].
- 3 The phonebook is stored alphabetically.  
Select a name, and then press the **ENT** switch.
- 4 Select the phone number you want to call, and then press the **ENT** switch.

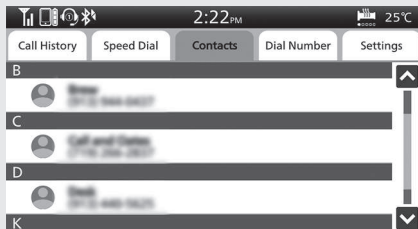

- 5 To end the call, push forward the  voice control switch on the left handlebar.
  - ▶ The same action can be done by selecting [End Call] on the screen.
- 6 Return to the riding information, previous screen or Home screen. **➡ P.40**

You can also perform the above settings by using the touch screen.

## Audio System *(Continued)*

### To Make a Call Using a Phone Number [Dial Number]

This function is disabled while the vehicle is in motion.

- 1 Select [Dial Number].
- 2 Press the ▲ sel switch or ▼ sel switch or push ◀ or ▶ on the ◀ ▶ sel left/right switch to enter a number, and then press the ENT switch to set the number.
  - ▶ When using [+]: Select [0], and then press and hold the ENT switch.

- 3 Select [CALL], and then press the ENT switch to make a call.

- ▶ To cancel the call, press the ENT switch.
- ▶ When making a call 1 second after the ENT switch pressed: Select [+ Wait], and then press the ENT switch.
- ▶ When making a call 2 seconds after the ENT switch pressed: Select [+ 2 sec], and then press the ENT switch.

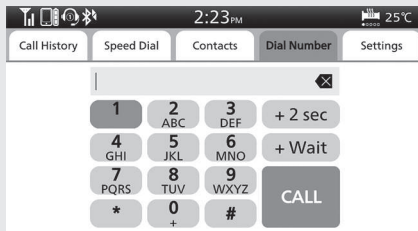



- 4 To end the call, push forward the  voice control switch on the left handlebar.
- ▶ The same action can be done by selecting [End Call] on the screen.

- 5 Return to the riding information, previous screen or Home screen.  **P.40**

You can also perform the above settings by using the touch screen.

## To Store a Phone Number in the Speed Dial List

Speed dial numbers can be stored.

- 1 Select [Speed Dial].
- 2 Select [Add Speed Dial], and then press the  switch.

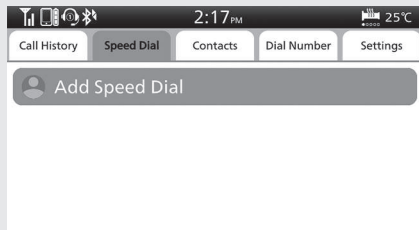

- 3 The phonebook appears.

## Audio System *(Continued)*

- Select the phone number you want to store, and then press and hold the **ENT** switch. The phone number will be stored in the speed dial list.

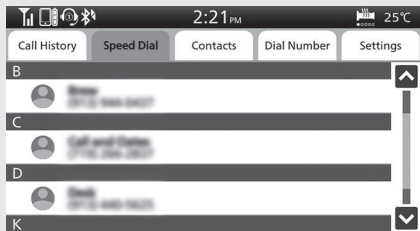

- Return to the riding information, previous screen or Home screen. **➡ P.40**  
You can also perform the above settings by using the touch screen.

## To Delete a Stored Speed Dial Number

- Select [Settings].
- Select the [Edit Speed Dial], and then press the **ENT** switch.

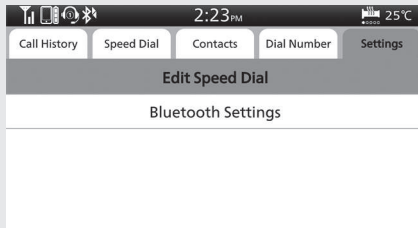

- 3 Select the phone number you want to delete, and then press and hold the **ENT** switch.

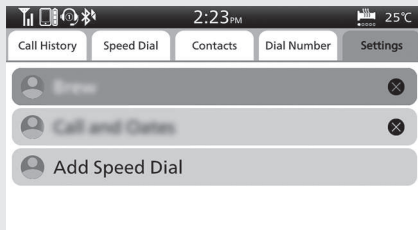

- 4 Return to the riding information, previous screen or Home screen. **➡P.40**  
 You can also perform the above settings by using the touch screen.

## Receiving a Call

When there is an incoming call, an audible notification sounds and the Incoming Call screen appears.

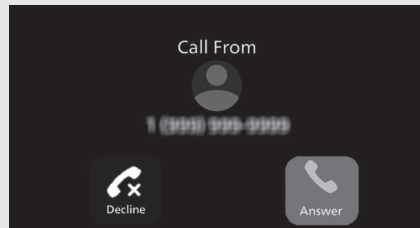

## Audio System *(Continued)*

### Ring Tone

If the connected mobile phone supports “in band ring tone”, the ring tone stored on the phone sounds automatically while receiving a call.

If “in band ring tone” is not supported, the ring tone stored in the audio system sounds.

### To Receive a Call

- 1 When a call comes in, push forward the  voice control switch on the left handlebar to receive the call.
  - ▶ The same action can be done by selecting [Answer] on the screen.

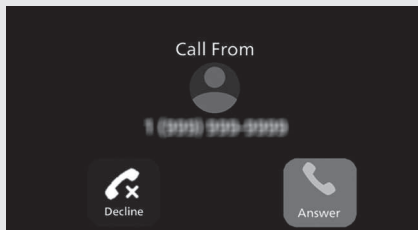

To adjust the phone volume:  P.95

## To Decline a Call

- 1 When a call comes in, push forward and hold the  voice control switch on the left handlebar to reject a call.
  - ▶ The same action can be done by selecting [Decline] on the screen.

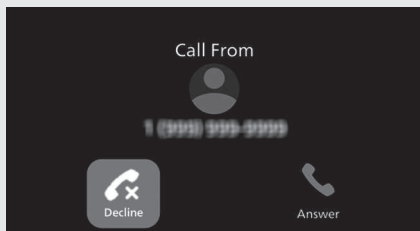

## To End a Call

- 1 While talking, push forward the  voice control switch on the left handlebar to end the call.
  - ▶ The same action can be done by selecting [End Call] on the screen.

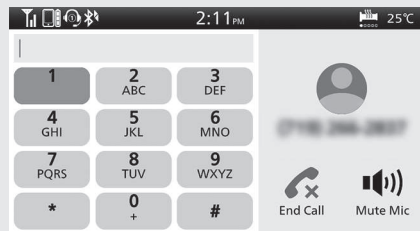

## **Audio System** *(Continued)*

### **Apple CarPlay**

If you connect an Apple CarPlay-compatible iPhone to the system via USB, you can use the multi-information display, instead of the iPhone display, to make phone calls, listen to music, view maps (navigation), and access messages.

- Only iPhone 5 or newer versions with iOS 10 or later are compatible with Apple CarPlay.
- Park your vehicle in a safe place before connecting your iPhone to Apple CarPlay and when launching any compatible apps.
- In no event shall Honda be liable for any damage or trouble that occurs in the use of iPhone.
- If a mobile network communication is unstable due to surrounding conditions or signal strength conditions, Apple CarPlay functions may not be available.
- To use Apple CarPlay, a headset connection is necessary. If headset connection is broken due to headset battery depletion or communication failure, Apple CarPlay cannot be used until the connection is restored.
- You cannot operate Apple CarPlay by the touch screen while the vehicle is in motion.

- Application and menu items displayed on the screen may differ depending on the connected device and iOS version.
- While connected to Apple CarPlay, calls are only made through Apple CarPlay. If you want to make a call with *Bluetooth*® handsfree calling, disconnect the USB cable from your iPhone and connect your iPhone via *Bluetooth*®.
- For details on countries and regions where Apple CarPlay is available, as well as information pertaining to function, refer to the Apple homepage.
- Apple CarPlay is a trademark of Apple Inc.

**To connect the paired device:**

➔ P.160

## **Audio System** *(Continued)*

### **Apple CarPlay Operating Requirements & Limitations**

Apple CarPlay requires a compatible iPhone with an active cellular connection and data plan. Your carrier's rate plans will apply.

Changes in operating systems, hardware, software, and other technology integral to providing Apple CarPlay functionality, as well as new or revised governmental regulations, may result in a decrease or cessation of Apple CarPlay functionality and services. Honda cannot and does not provide any warranty or guarantee of future Apple CarPlay performance or functionality.

It is possible to use 3rd party apps if they are compatible with Apple CarPlay. Refer to the Apple homepage for information on compatible apps.

### **Use of User and Vehicle Information**

The use and handling of user and vehicle information transmitted to/from your iPhone by Apple CarPlay is governed by the Apple iOS terms and conditions and Apple's Privacy Policy.



## Connected Services Settings

From this screen, you can go to various setup options for Apple CarPlay.

## To Setup Apple CarPlay

Use of Apple CarPlay will result in the transmission of certain user and vehicle information (such as vehicle location, speed, and status) to your iPhone to enhance the Apple CarPlay experience. You will need to consent to the sharing of this information on the screen.

- 1 Pair the headsets. ➔ P.165
  - 2 Connect your iPhone using a certified cable to the USB socket. ➔ P.201
    - ▶ If the following screen is displayed, Apple CarPlay can not be used, but USB power can be supplied.
1. Select [OK], and then press the **ENT** switch.

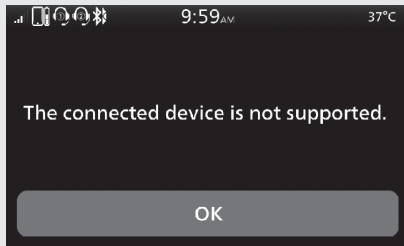

To enable Apple CarPlay: ➔ P.197

## Audio System *(Continued)*

- 3 When the disclaimer message appears on the screen, select [Enable], and then press the **[ENT]** switch.
  - ▶ Set [Remember My Choice] to ON so that you will not be asked the next time you connect.

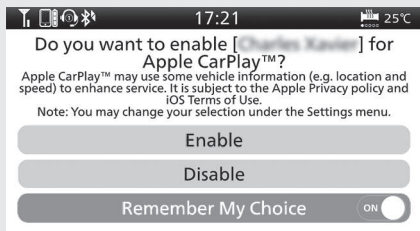

**[Enable] when [Remember My Choice] is [OFF]:** Allows only once. (Prompt shows again next time.)

**[Enable] when [Remember My Choice] is [ON]:** Allows anytime. (Prompt does not show again.)

**[Disable] when [Remember My Choice] is [OFF]:** Does not allow this consent.

**[Disable] when [Remember My Choice] is [ON]:** Does not allow anytime. (Prompt does not show again.)

- 4 Enable the Apple CarPlay setting. ➡ P.197
- 5 Apple CarPlay menu screen appears.

You can also perform the above settings by using the touch screen.

**To display the prompt:** ➡ P.199

## To Enable or Disable Apple CarPlay

- 1 Select [Connected Services], and then press the **ENT** switch.

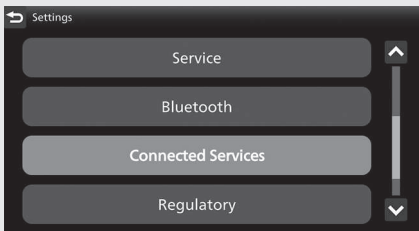

- 2 Select [Apple CarPlay], and then press the **ENT** switch.

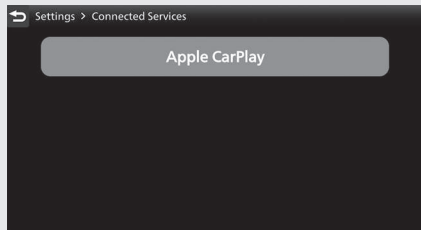

- 3 Select a target device name, and then press the **ENT** switch.

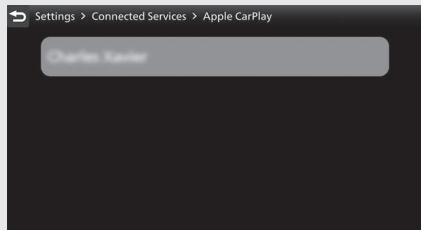

## Audio System *(Continued)*

To enable Apple CarPlay:

- 4 Select [Enable Apple CarPlay], and then press the **ENT** switch to [ON] (enable) the function.

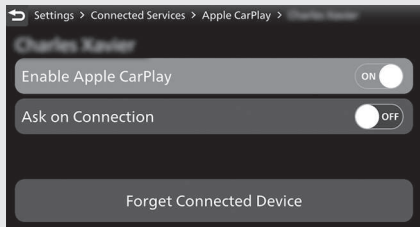

- 5 Return to the riding information, previous screen or Home screen. ➡ P.40

You can also perform the above settings by using the touch screen.

To disable Apple CarPlay:

- 4 Select [Enable Apple CarPlay], and then press the **ENT** switch to [OFF] (disable) the function.

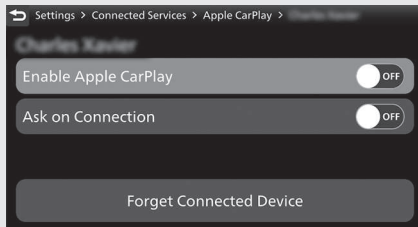

- 5 Return to the riding information, previous screen or Home screen. ➡ P.40

You can also perform the above settings by using the touch screen.

## To Select Ask On or Ask Off of the Apple CarPlay disclaimer Screen

- 1 Select [Connected Services], and then press the **ENT** switch.

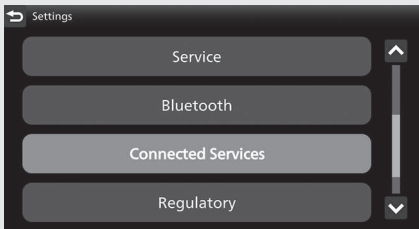

- 2 Select [Apple CarPlay], and then press the **ENT** switch.

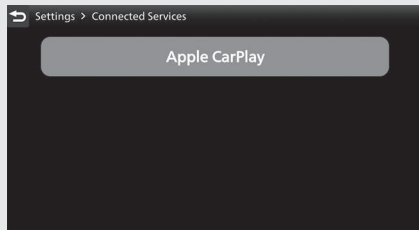

- 3 Select a target device name, and then press the **ENT** switch.

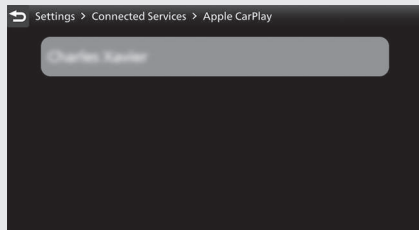

## Audio System *(Continued)*

To ask on connection:

- 4 Select [Ask on Connection], and then press the **ENT** switch to [ON] (ask on) the function.

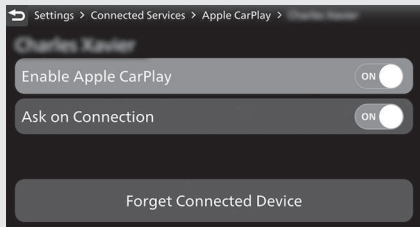

- 5 Return to the riding information, previous screen or Home screen. ➡P.40

You can also perform the above settings by using the touch screen.

To ask off connection:

- 4 Select [Ask on Connection], and then press the **ENT** switch to [OFF] (ask off) the function.

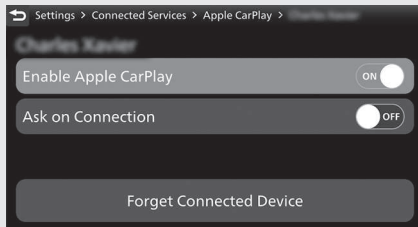

- 5 Return to the riding information, previous screen or Home screen. ➡P.40

You can also perform the above settings by using the touch screen.

## **| To Connect Your iPhone**

- Do not leave your device in the vehicle (under the front seat or under the rear seat etc.). High heat will damage it.
- We recommend backing up your data before playing it.
- iPhone can be charged with the USB cable when the ignition switch is in the **|** (On) position. The charging time may be longer than usual.
- We recommend covering your devices with an audio pouch, or soft fabric or cover to protect them from damage.
- Be careful to not get the USB connector wet.
- Do not connect with a hub.
- Do not connect incompatible devices.
- If the audio system does not recognise the iPhone, try reconnecting it a few times or reboot the device.

**To connect your iPhone:**  **P.226**

## **| To Disconnect Your iPhone**

You can disconnect your iPhone at any time. Make sure to follow the device's instructions on how to disconnect the device from the cable.

## Audio System *(Continued)*

### Apple CarPlay Menu

#### Apple CarPlay menu screen



Go back to Home screen

Go back to Apple CarPlay menu screen

#### Home screen

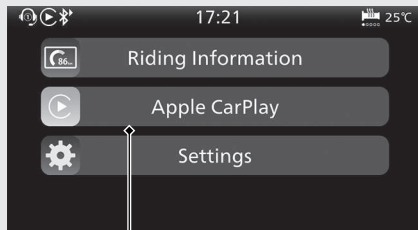

Go to Apple CarPlay menu screen



**Phone**

Access the contact list, make phone calls, or listen to voice mail.

**Music**

Play music stored on your iPhone.

**Maps**

Display Apple CarPlay map and use the navigation function just as you would on your iPhone.

**Messages**

Check and reply to text messages, or have messages read to you.

**Honda**

Go back to the Home screen.



Go back to the Apple CarPlay menu screen.

## Audio System *(Continued)*

### Operating Apple CarPlay with Siri

To activate Siri, pairing with device such as a headset (for rider) must be paired. ➔P.165

#### To Activate Siri

- 1 Start Apple CarPlay. ➔P.195
- 2 Unlock your iPhone and enable Siri.
  - ▶ For details, refer to the iPhone User Guide, etc.
- 3 Push forward the  voice control switch on the left handlebar.

- 4 Say a voice command through the paired headset.

Siri may not be recognised correctly due to the effect of wind noise during running or external noise. In that case, try to change the position of the microphone or to adjust the windscreen height (CRF1100A2/A4/D2/D4). ➔P.296

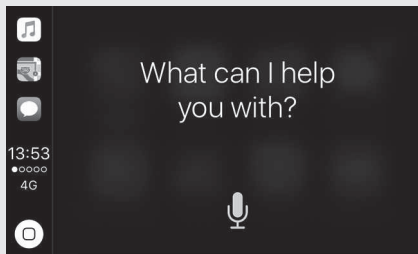

## Below Are Examples of Questions and Commands for Siri

Please visit [www.apple.com/ios/siri](http://www.apple.com/ios/siri).

## To Deactivate Siri

- 1 Push forward the  voice control switch on the left handlebar.

You can also perform the above settings by using the touch screen.

Siri is a trademark of Apple Inc.

# Starting the Engine

## CRF1100A/A2/A4

Start your engine using the following procedure, regardless of whether the engine is cold or warm.

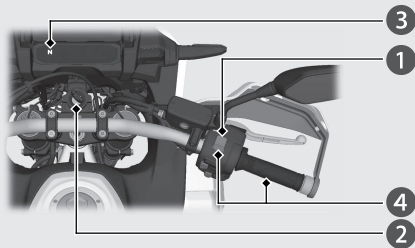

### NOTICE

- If the engine does not start within 5 seconds, turn the ignition switch to the **○** (Off) position and wait 10 seconds before trying to start the engine again to recover battery voltage.
- Extended fast idling and reving the engine can damage the engine, and the exhaust system.
- Snapping the throttle or fast idling for more than about 5 minutes may cause exhaust pipe discoloration.
- The engine will not start if the throttle is fully open.

- 1 Make sure the engine stop switch is in the **○** (Run) position.
- 2 Turn the ignition switch to the **I** (On) position.
- 3 Shift the transmission to Neutral (**N** indicator come on). Alternatively, pull in the clutch lever to start your vehicle with the transmission in gear so long as the side stand is raised.
- 4 Press the **START** **Ⓢ** button with the throttle completely closed.

### If the engine does not start:

- 1 Open the throttle fully and press the **START** **Ⓢ** button for 5 seconds.
- 2 Repeat the normal starting procedure.
- 3 If the engine starts, open the throttle slightly if idling is unstable.
- 4 If the engine does not start, wait 10 seconds before trying steps 1 & 2 again.

**If Engine Will Not Start** ➔ P.299

**CRF1100D/D2/D4**

Start your engine using the following procedure, regardless of whether the engine is cold or warm.

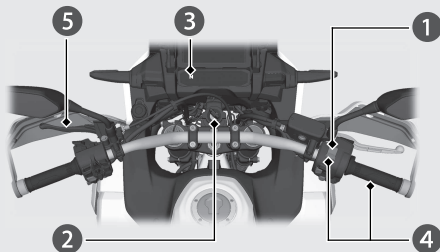
**NOTICE**

- If the engine does not start within 5 seconds, turn the ignition switch to the **○** (Off) position and wait 10 seconds before trying to start the engine again to recover battery voltage.
- Extended fast idling and revving the engine can damage the engine, and the exhaust system.
- Snapping the throttle or fast idling for more than about 5 minutes may cause exhaust pipe discoloration.
- The engine will not start if the throttle is fully open.

- ① Make sure the engine stop switch is in the **○** (Run) position.
- ② Turn the ignition switch to the **I** (On) position.
- ③ Check the transmission in Neutral (**N** indicator come on).
- ④ Press the **START** (**⚡**) button with the throttle completely closed.
- ⑤ Make sure the parking brake lever is released before riding. **➡ P.129**

**| If Engine Does Not Start ➡ P.206****When you stop the engine**

- ① To stop the engine, shift the transmission to Neutral (**N** indicator comes on).
  - ▶ If you turn the ignition switch to the **○** (Off) position when the vehicle in gear, the engine will shut off with the clutch disengaged.
- ② Turn the ignition switch to the **○** (Off) position.
- ③ Set the parking brake when you park the vehicle. **➡ P. 129**

# Shifting Gears

## CRF1100A/A2/A4

Your vehicle transmission has 6 forward gears in a one-down, five-up shift pattern.

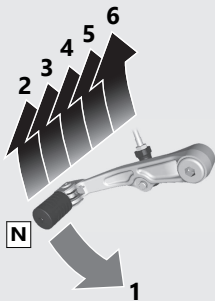

If you put the vehicle in gear with the side stand down, the engine will shut off.

## CRF1100D/D2/D4

Your vehicle is equipped with an automatically controlled 6-speed transmission. It can be shifted automatically (by AT MODE) or manually (by MT MODE).

## Dual Clutch Transmission

### CRF1100D/D2/D4

In order to respond to rider demands in a broad range of situations, the transmission is equipped with three operating modes, AT MODE (including D mode for regular operation and three levels of S mode for sporty riding); and MT MODE (MT mode for a 6-speed manual operation), which delivers the same shift feel as a manual transmission.

- ▶ Always use the recommended tyres and sprockets to ensure correct Dual Clutch Transmission operation.

The Dual Clutch Transmission system runs a self check immediately after starting the engine.

"N" appears in the gear position indicator window for a few seconds, then goes out. While "N" appears, you cannot shift into gear.

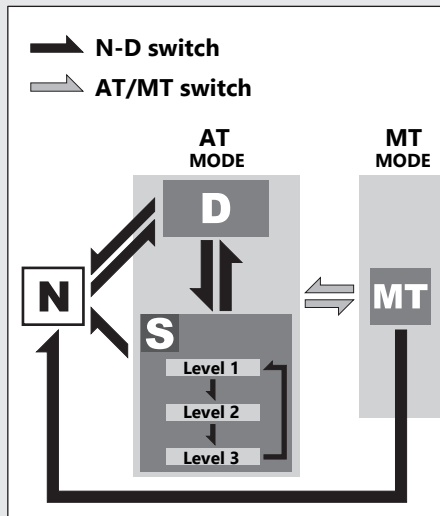

## Shifting Gears *(Continued)*

**Neutral (N):** Neutral is selected automatically when you turn the ignition switch to the **I** (On) position.

### **If neutral is not selected when you turn the ignition switch to the **I** (On) position.**

- ▶ Turn the ignition switch to the **O** (Off) position and then to the **I** (On) position again.
- ▶ If neutral is still not selected after turning the ignition switch to the **O** (Off) position, and then to the **I** (On) position again. **➡ P.305**  
You may hear (click) noises when the transmission shifts to Neutral (N). This is normal.

### **When you can change between N and D**

- ▶ Vehicle is stopped and the engine is idling.
- ▶ Throttle is completely closed. It is not possible to change from Neutral to D mode while the throttle is applied.
- ▶ You cannot change between N and D mode while the wheels are rotating.
- ▶ Side stand is raised.

#### **NOTICE**

To prevent clutch damage, do not use the throttle to keep the vehicle stopped uphill.



**AT MODE:** In this mode the gears are shifted automatically according to your riding conditions.

And also using the shift up switch (+) or shift down switch (-), you can temporarily shift up or down in AT MODE by using the shift switch. These switches are convenient when you want to temporarily down-shift in front of a curve, etc.  **P.214**

You can choose between two modes within AT MODE: D mode and S mode.

**D mode (AT):** This is the standard mode when AT MODE is selected. Select D mode for regular operation and efficient fuel economy.

**S mode (AT):** Select this mode while riding in AT MODE when you need more power, such as when overtaking, climbing hills, pulling away.

S mode has three levels of adjustment.

**MT MODE:** MT MODE (6-speed manual operation) You can choose between 6 gears in this mode.

## Shifting Gears *(Continued)*

### Changing between Neutral and AT MODE/MT MODE

#### Changing from Neutral (N) to AT MODE

Press the **D-S** side of the N-D switch (①).  
The D mode indicator comes on, "1" is shown in the gear position indicator and first gear is selected.

#### Changing from AT or MT MODE to Neutral

Press **N** on the N-D switch (②).

#### Changing between D mode and S mode while in AT MODE

Press the **D-S** side of the N-D switch. The S or D is shown in the gear position indicator. (③, ④).

### Changing between AT MODE and MT MODE

Press the AT/MT switch (⑤).

The AT indicator goes out while MT MODE is selected (⑥).

The gear position is displayed on the gear position indicator while MT MODE is selected (⑥).

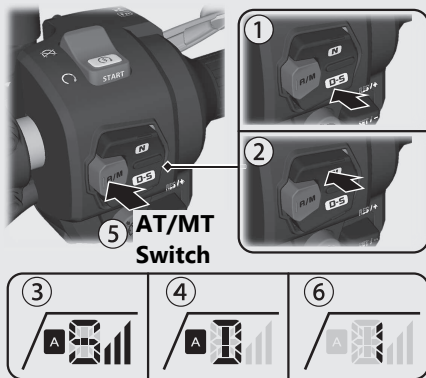



## S mode level selecting while in AT MODE

While in S mode, press and hold the **D-S** side of the N-D (1) switch.

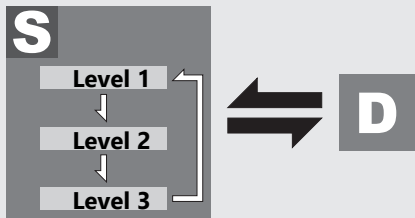
- ▶ Close the throttle completely. Then select the desired level of the S mode.



 Press and hold the **D-S** side of the N-D switch

 Press the **D-S** side of the N-D switch

### N-D switch

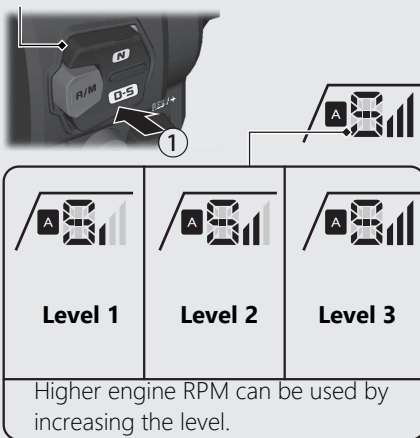

The selected level is maintained even when the ignition switch is turned to the  (Off) position, or transmission is switched to out of S mode.

## Shifting Gears *(Continued)*

### Riding in MT MODE

Shift up and down with the shift up switch (+) and shift down switch (-).

The selected gear is shown on the gear position indicator.

- ▶ If the MT MODE is selected, the transmission does not shift up automatically. Do not allow the engine revs to go into the red zone.
- ▶ The transmission automatically shifts down when you slow down, even in MT MODE.
- ▶ You will start from 1st gear even if MT MODE is selected.

### Gear shift operation

Shifting Up:

Press the shift up switch (+) (7).

Shifting Down:

Press the shift down switch (-) (8).

You cannot continue shifting gear by keeping the shift switch pressed.

To continue shifting gear release the switch and press it again.

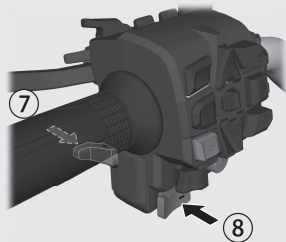

### Shift Limit

You cannot downshift if the engine will exceed the rev limit.

# Cruise Control

The cruise control system allows you to maintain a steady speed within a specified range.

The available speed setting range and operating gear are listed below:

## CRF1100A/A2/A4

Available Speed setting range	50 – 160 km/h (30 - 100 mph)
Operating gear	From 4th to 6th gear

## CRF1100D/D2/D4

Available Speed setting range	50 – 160 km/h (30 - 100 mph)
Operating gear	From 3rd to 6th gear

When cruise control is on, your speed will still vary slightly, particularly going up and down hills.

Cruise control is intended for use only on straight, uncongested highways. Do not use cruise control on city streets, winding roads, during bad weather, or at any other time when you need total control of the throttle.



## WARNING

Improper use of the cruise control can lead to a crash in which you could be seriously hurt or killed.

Use the cruise control only when travelling on open highways in good weather.

## Cruise Control *(Continued)*

### To Set Cruise Control

- 1 Make sure the travelling speed and operating gear are conformed to the requirements of the system.  
Any speed other than the available range will not be memorised.
- 2 Press the  cruise control main switch. (The  cruise control main indicator will come on.)
- 3 Accelerate to the desired speed.
- 4 Push the **RES / +** **SET / -** cruise control lever to **SET / -** side. (The cruise control **SET** indicator will come on.) Your current travelling speed is memorised.

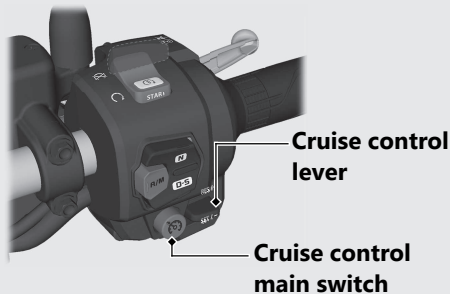
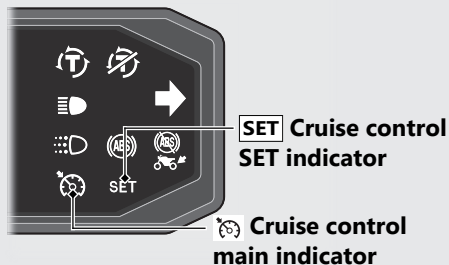

## To Change the Set Speed To Fine Tune the Set Speed

- 1 Select the riding information. **➔ P.40**
- 2 Display the cruise control set speed on the multi-information display.
- 3 To increase the set speed: tap the **RES / +** **SET / -** cruise control lever to **RES / +** side.  
To decrease the set speed: tap the **RES / +** **SET / -** cruise control lever to **SET / -** side.
- 4 The set speed is displayed in the multi-information display.



**Cruise control set speed**

Each quick tap (brief push and release) on either side will change your speed by 1 km/h or 1 mph (depending on mileage meter set unit).

Any speed other than the possible setting range will not be indicated (stops at the upper or lower limit speed).

The system will accelerate your vehicle automatically. When you reach the desired speed, release the **RES / +** **SET / -** cruise control lever.

### To Change the Set Speed Continuously

- To increase the set speed: push and hold the **RES / +** **SET / -** cruise control lever to **RES / +** side.  
If the **RES / +** **SET / -** cruise control lever is pushed and held to **RES / +** side continuously, the set speed indicated in the multi-information display stops at the upper limit of the possible setting range.

## Cruise Control *(Continued)*

- To decrease speed: push and hold the **RES / +** **SET / -** cruise control lever to **SET / -** side. The system will automatically slow your motorcycle. When you reach the desired speed, release the **RES / +** **SET / -** cruise control lever. If the **RES / +** **SET / -** cruise control lever is pushed and held to **SET / -** side continuously, the set speed indicated in the multi-information display stops at the lower limit of the possible setting range.

### To Manually Increase the Set Speed

- 1 Use the throttle to accelerate until you reach the desired speed.
- 2 Push and release the **RES / +** **SET / -** cruise control lever to **SET / -** side.

### To Manually Increase Vehicle Speed

- 1 Use the throttle in the normal manner to accelerate.
- 2 To return to the set speed, close the throttle and coast without applying the brakes. The cruise system will maintain the speed you previously set.

### To Cancel Cruise Control

#### To Disengage the System

- Press the cruise control main switch. (The  cruise control main indicator goes off and the set speed will be erased from memory.)



## To Temporarily Disengage the System

- 1 Perform one of the following operations to disengage the system temporarily. (**SET** Cruise control SET indicator temporarily goes off but the set speed remains in memory.)
  - Apply the brake lever or pedal.
  - Rotate the throttle grip past the automatically closed position in the deceleration direction.
  - **CRF1100A/A2/A4**  
Disengage the clutch or operate the shift lever.

- 2 To resume cruise control:
  - If you are still over 50 km/h (30 mph), push and release the **RES / +** **SET / -** cruise control lever to **RES / +** side.
  - If you are under 50 km/h (30 mph), use the throttle to increase road speed above 50 km/h (30 mph) and then push and release the **RES / +** **SET / -** cruise control lever to **RES / +** side.

# Emergency Stop Signal

Emergency stop signal activates when the system detects hard braking about 50 km/h (31 mph) or above to alert drivers behind you about sudden braking by rapidly flashing both turn signal lights. This may help to alert drivers behind you to take appropriate means to avoid a possible collision with your vehicle.

The emergency stop signal stops operating when:

- You release the brake lever and pedal.
- The ABS is deactivated.
- Your vehicle's decelerating speed becomes moderate.
- You press the hazard switch.

## When the system activates:



**1 Hard braking**

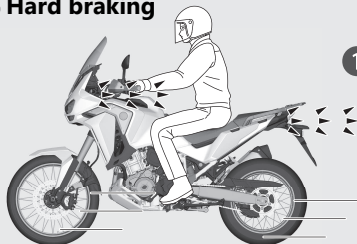

**1 Brakelight come on**

**2 Both turn signals flash**

**2 Both turn signal indicators blink**

- ▶ The emergency stop signal is not a system that can prevent a possible rear-end collision caused by your hard braking. It is always recommended to avoid hard braking unless it is absolutely necessary.
- ▶ The emergency stop signal does not activate with the hazard switch pressed in.
- ▶ If the ABS stops working for a certain period during braking, the emergency stop signal may not activate at all.

# DRL (Daytime Running Light)

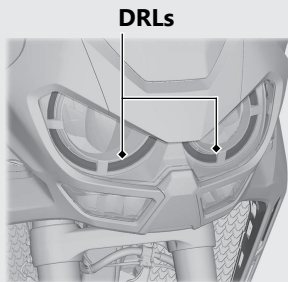

When the headlight dimmer/passing light control switch is turned to the  position, the headlights and DRL are switched automatically according to the ambient brightness.

When it gets brighter, DRL lights up, and when it gets dark, low beam lights up and DRL decreases to the brightness of the position light.



## To select the DRL auto and off

Each time the ignition switch is turned to the (On) position, the DRL will automatically be set to on.

- 1 Start the engine.
- 2 Select the DRL of pop-up information using the  function switch.
- 3 Push forward or pull backward the  function lever to select the [AUTO] or [Dismiss] of the DRL.



⇨ **Push forward the function lever** 

⇨ **Pull backward the function lever** 

# Cornering Light

The cornering light lights up the direction of travel of the vehicle when cornering.

## Operating conditions:

When the headlights are on:

- Vehicle has been ridden at a speed of over 10 km/h (6 mph).
- When the vehicle banking left or right.

Three-step lighting state is switched by the bank angle.

## Cornering light adjusting screw location

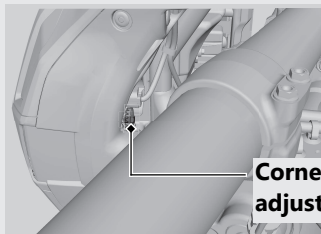

Cornering light adjusting screw

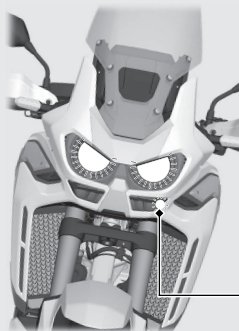

Cornering light

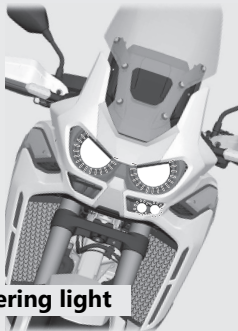

# Refuelling

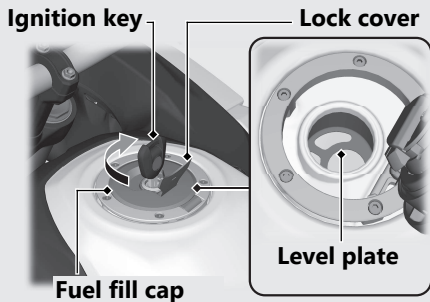

Do not fill with fuel above the level plate.

**Fuel type:** Unleaded petrol only

**Fuel octane number:** Your vehicle is designed to use Research Octane Number (RON) 91 or higher.

**Tank capacity:**

CRF1100A/D 18.8 L (4.97 US gal, 4.14 Imp gal)

CRF1100A2/A4/D2/D4 24.8 L (6.55 US gal, 5.46 Imp gal)

**Refuelling and Fuel Guidelines** ➔ P.15

## Opening the Fuel Fill Cap

Open the lock cover, insert the ignition key, and turn it clockwise to open the fuel fill cap.

## Closing the Fuel Fill Cap

- 1 After refuelling, push the fuel fill cap closed until it locks.
- 2 Remove the key and close the lock cover.
  - ▶ The key cannot be removed if the fuel fill cap is not locked.

## **⚠ WARNING**

Petrol is highly flammable and explosive. You can be burned or seriously injured when handling fuel.

- Stop the engine, and keep heat, sparks, and flame away.
- Handle fuel only outdoors.
- Wipe up spills immediately.

# Accessory Socket

CRF1100A2/A4/D2/D4

The accessory socket is located in the left side inner panel cover.

Use accessory devices at your own risk. In no event shall Honda be liable for any damages to your accessory device when in use.

Open the cover to access the socket.

Rated capacity is

**24 W (12 V, 2 A).**

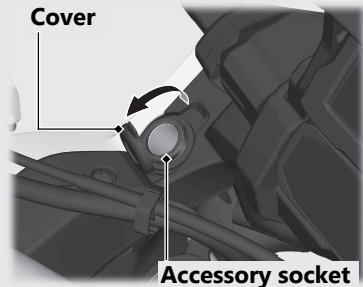

- ▶ To prevent the battery from becoming weak (or dead), keep the engine running while drawing current from the socket.
- ▶ To prevent entry of foreign matter into the socket, be sure to close the cover when the socket is not used.
- ▶ Carefully secure all connected devices, as vibration may cause damage to them or they could shift unexpectedly.

## NOTICE

- Using any heat-generating accessory or improperly rated accessory can damage the socket.
- Do not use the socket in wet conditions, when or while washing or any other wet conditions as these will damage the socket.
- Do not allow the accessory's harness to become pinched or trapped.
- Do not allow the accessory's harness to interfere with the steering or controls.

# USB Socket

The USB socket is located in the right side front turn signal light cover (CRF1100A/D) or right side inner panel cover (CRF1100A2/A4/D2/D4).

Use USB devices at your own risk. In no event shall Honda be liable for any damage to your USB device when in use.

Only USB devices within the following specifications can be connected.

Open the cover to access the socket.

Rated capacity is

**7.5 W (5 V, 1.5 A).**

## To connect your USB device

- 1 Open the cover to access the USB socket.

USB socket

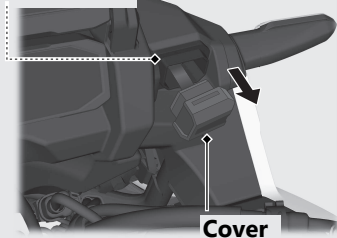



- 2 Connect a certified USB cable to the socket.
- 3 Route the USB cable along the recess.
- 4 Pass the USB cable through the cover slit and close the cover.

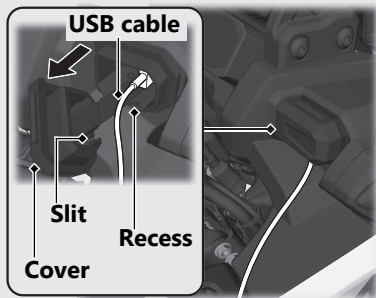

- ▶ To prevent the battery from becoming weak (or dead), keep the engine running while drawing current from the socket.
- ▶ To prevent entry of foreign matter into the socket, be sure to close the cover.
- ▶ Carefully secure all connected devices, as vibration may cause damage to them or they could shift unexpectedly.

**NOTICE**

- Using any heat-generating USB devices or improperly rated USB devices can damage the socket.
- Do not use the USB socket in wet conditions, when or while washing or any other wet conditions as these will damage the USB socket.
- Do not allow the USB's harness to become pinched or trapped.
- Do not allow the USB's harness to interfere with the steering or controls.

# Storage Equipment

## Helmet holder

A helmet holder is located under the rear seat.

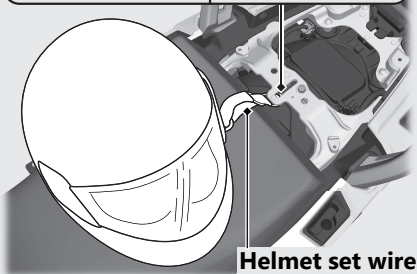
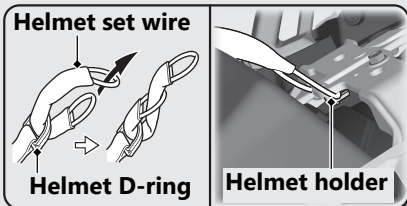

► Use the helmet holder only when parked.

**Removing the rear seat** ➔ P.255

## **⚠WARNING**

Riding with a helmet attached to the holder can interfere with your ability to safely operate the vehicle and could lead to a crash in which you can be seriously hurt or killed.

Use the helmet holder only while parked. Do not ride with a helmet secured by the holder.

## Helmet Set Wire

The helmet set wire is secured on the rear fender under the rear seat.

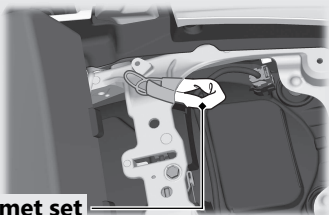

**Helmet set wire**

**Removing the rear seat** ➔ P.255

## Document Bag

The document bag is located on the underside of the front seat.



**Document bag**

**Removing the front seat** ➔ P.253

## Storage Equipment *(Continued)*

### Fuse Puller, Hex Wrench, Standard/Phillips Screwdriver, Screwdriver Handle

The fuse puller, hex wrench, standard/phillips screwdriver and screwdriver handle are located on the underside of the rear seat.

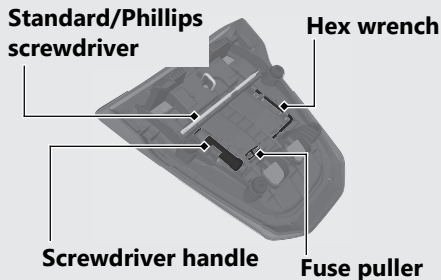

Removing the rear seat → P.255

## Tool Kit

The tool kit is located in the tool box.

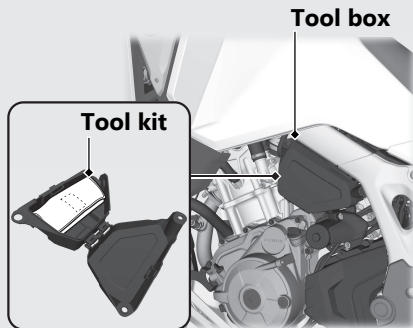

Removing the tool box → P.259

## Rear Carrier

CRF1100A2/A4/D2/D4

Never exceed the maximum weight limit.

**Maximum Weight:** 10 kg (22 lb)

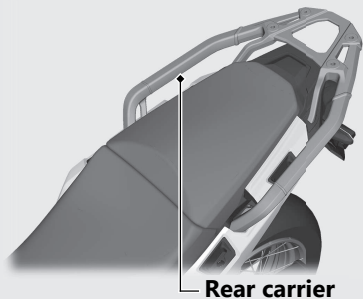

# Maintenance

Please read "Importance of Maintenance" and "Maintenance Fundamentals" carefully before attempting any maintenance. Refer to "Specifications" for service data.

<b>Importance of Maintenance</b> .....	P. 233	<b>Coolant</b> .....	P. 266
<b>Maintenance Schedule</b> .....	P. 234	<b>Brakes</b> .....	P. 268
<b>Maintenance Fundamentals</b> .....	P. 237	<b>Side Stand</b> .....	P. 272
<b>Tool</b> .....	P. 249	<b>Drive Chain</b> .....	P. 273
<b>Removing &amp; Installing Body</b>		<b>Wheels</b> .....	P. 277
<b>Components</b> .....	P. 250	<b>Clutch</b> .....	P. 279
Battery.....	P. 250	<b>Throttle</b> .....	P. 282
Battery Box Cover .....	P. 251	<b>Crankcase Breather</b> .....	P. 283
Clip.....	P. 252	<b>Other Adjustments</b> .....	P. 284
Front Seat.....	P. 253	Adjusting the Headlight Aim .....	P. 284
Rear Seat.....	P. 255	Adjusting the Brake Lever .....	P. 285
Skid Plate.....	P. 257	Adjusting the Front Suspension .....	P. 286
Tool Box .....	P. 259	Adjusting the Rear Suspension.....	P. 290
<b>Engine Oil</b> .....	P. 260	Adjusting the Windscreen Height.....	P. 296

## Importance of Maintenance

Keeping your vehicle well-maintained is absolutely essential to your safety and to protect your investment, obtain maximum performance, avoid breakdowns, and reduce air pollution. Maintenance is the owner's responsibility. Be sure to inspect your vehicle before each ride, and perform the periodic checks specified in the Maintenance Schedule.

➔ P. 234

### **⚠ WARNING**

Improperly maintaining your vehicle or failing to correct a problem before you ride can cause a crash in which you can be seriously hurt or killed.

Always follow the inspection and maintenance recommendations and schedules in this owner's manual.

## Maintenance Safety

Always read the maintenance instructions before you begin each task, and make sure that you have the tools, parts, and skills required. We cannot warn you of every conceivable hazard that can arise in performing maintenance. Only you can decide whether or not you should perform a given task.

Follow these guidelines when performing maintenance.

- Stop the engine and remove the key.
- Place your vehicle on a firm, level surface using the side stand or a maintenance stand to provide support.
- Allow the engine, muffler, brakes, and other high-temperature parts to cool before servicing as you can get burned.
- Run the engine only when instructed, and do so in a well-ventilated area.

## Maintenance Schedule

The maintenance schedule specifies the maintenance requirements necessary to ensure safe, dependable performance, and proper emission control.

Maintenance work should be performed in accordance with Honda's standards and specifications by properly trained and equipped technicians. Your dealer meets all of these requirements. Keep an accurate record of maintenance to help ensure that your vehicle is properly maintained.

Make sure that whomever performs the maintenance completes this record.

All scheduled maintenance is considered a normal owner operating cost and will be charged to you by your dealer. Retain all receipts. If you sell the vehicle, these receipts should be transferred with the vehicle to the new owner.

Honda recommends that your dealer should road test your vehicle after each periodic maintenance is carried out.



Items		Pre-ride Check P. 237	Frequency*1						Annual Check	Regular Replace	Refer to page
			× 1,000 km	1	12	24	36	48			
			× 1,000 mi	0.6	8	16	24	32			
Fuel Line	🔧			I	I	I	I	I		-	
Fuel Level		I								224	
Throttle Operation	🔧	I		I	I	I	I	I		282	
Air Cleaner *2	🔧				R		R			248	
Crankcase Breather*3				C	C	C	C			283	
Spark Plug	🔧				I		R			-	
Valve Clearance	🔧				I		I			-	
Engine Oil		I		R	R	R	R	R	R	262	
Engine Oil Filter				R		R		R		262	
Clutch Oil Filter*6				R		R		R		264	
Engine Idle Speed	🔧			I	I	I	I	I		-	
Radiator Coolant *5		I		I	I	I	I	I	3 Years	266	
Cooling System	🔧			I	I	I	I	I		-	
Secondary Air Supply System	🔧				I		I			-	
Evaporative Emission Control System	🔧				I		I			-	

### Maintenance Level

- 🔧 : Intermediate. We recommend service by your dealer, unless you have the necessary tools and are mechanically skilled. Procedures are provided in an official Honda Shop Manual.
- 🔧 : Technical. In the interest of safety, have your vehicle serviced by your dealer.

### Maintenance Legend

- I : Inspect (clean, adjust, lubricate, or replace, if necessary)
- L : Lubricate
- R : Replace
- C : Clean

## Maintenance Schedule

Items	Pre-ride Check P. 237	Frequency*1					Annual Check	Regular Replace	Refer to page	
		× 1,000 km	1	12	24	36				48
		× 1,000 mi	0.6	8	16	24				32
Exhaust Gas Control Actuator Cable	✘				☑	☑			–	
Drive Chain*4	☑	Every 1,000 km (600 mi): ☑ ☑							273	
Drive Chain Slider*4			☑	☑	☑	☑			276	
Brake Fluid *5	☑		☑	☑	☑	☑	☑	2 Years	268	
Brake Pads Wear	☑		☑	☑	☑	☑	☑		269	
Brake System			☑	☑	☑	☑	☑		237	
Brakelight Switch			☑	☑	☑	☑	☑		271	
Brake Lock Operation*6	✘		☑	☑	☑	☑			270	
Headlight Aim			☑	☑	☑	☑	☑		284	
Lights/Horn	☑								–	
Engine Stop Switch	☑								–	
Clutch System*7	☑		☑	☑	☑	☑	☑		279	
Side Stand	☑		☑	☑	☑	☑	☑		272	
Suspension	✘		☑	☑	☑	☑	☑		–	
Nuts, Bolts, Fasteners*4	✘		☑	☑	☑	☑	☑		–	
Wheels/Tyres*4	✘	☑	Every 6,000 km (4,000 mi): ☑				☑		245, 277	
Steering Head Bearings	✘		☑	☑	☑	☑	☑		–	

### Notes:

\*1: At higher odometer readings, repeat at the frequency interval established here.

\*2: Service more frequently when riding in unusually wet or dusty areas.

\*3: Service more frequently when riding in rain or at full throttle.

\*4: Service more frequently when riding OFF-ROAD.

\*5: Replacement requires mechanical skill.

\*6: CRF1100D/D2/D4 only

\*7: CRF1100A/A2/A4 only

## Pre-ride Inspection

To ensure safety, it is your responsibility to perform a pre-ride inspection and make sure that any problem you find is corrected. A pre-ride inspection is a must, not only for safety, but because having a breakdown, or even a flat tyre, can be a major inconvenience.

Check the following items before you get on your vehicle:

- Fuel level - Fill fuel tank when necessary. ➔ P. 224
- Throttle - Check for smooth opening and full closing in all steering positions. ➔ P. 282
- Engine oil level - Add engine oil if necessary. Check for leaks. ➔ P. 260
- Coolant level - Add coolant if required. Check for leaks. ➔ P. 266

- Drive chain - Check condition and slack, adjust and lubricate if necessary. ➔ P. 273
- Brakes - Check operation;  
Front and Rear: check brake fluid level and pads wear. ➔ P. 268, ➔ P. 269
- Lights and horn - Check that lights, indicators and horn function properly.
- Engine stop switch - Check for proper function. ➔ P. 117
- **CRF1100A/A2/A4**  
Clutch - Check operation;  
Adjust freeplay if necessary. ➔ P. 279
- Side stand ignition cut-off system - Check for proper function. ➔ P. 272
- Wheels and tyres - Check condition, air pressure and adjust if necessary. ➔ P. 245

## Maintenance Fundamentals

Before riding off-road check all of the preceding plus the following:

- Make sure spokes are tight. Check the rims for any damage. ➤ P. 277
- Be sure the fuel fill cap is securely fastened. ➤ P. 224
- Check for loose cables and other parts, and anything that appears abnormal.
- Use a wrench to check the tightness of all accessible nuts, bolts and fasteners.

### Replacing Parts

Always use Honda Genuine Parts or their equivalents to ensure reliability and safety. When ordering coloured components, specify the model name, colour, and code mentioned on the colour label.

The colour label is attached to the rear fender under the rear seat. ➤ P. 255

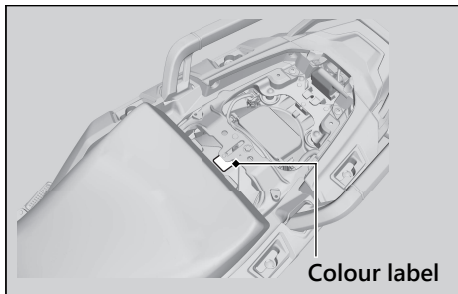

### **⚠ WARNING**

Installing non-Honda parts may make your vehicle unsafe and cause a crash in which you can be seriously hurt or killed.

Always use Honda Genuine Parts or equivalents that have been designed and approved for your vehicle.

## Lithium-Ion (Li-Ion) Battery

Your vehicle has a lithium-ion (li-ion) battery. Clean the battery terminals if they become dirty or corroded.



This symbol on the battery means that this product must not be treated as household waste.

### NOTICE

An improperly disposed of battery can be harmful to the environment and human health. Always confirm local regulations for proper battery disposal instruction.

### What to do in an emergency

If any of the following occurs, immediately see your doctor.

- Electrolyte splashes into your eyes:
  - ▶ Wash your eyes repeatedly with cool water for at 15 minutes. Using water under pressure can damage your eyes.
- Electrolyte splashes onto your skin:
  - ▶ Remove affected clothing and wash your skin thoroughly using water.

- Electrolyte splashes into your mouth
  - ▶ Rinse mouth thoroughly with water, and do not swallow.

## ⚠ WARNING

The battery contains flammable organic solvent as electrolyte.

You can be burned or seriously injured if the battery is handled improperly.

- Keep the battery away from heat, sparks, and flame.
- Keep the battery out of the reach of children.
- Do not disassemble or modify the battery or battery terminals.
- Do not short-circuit the battery with metal tools or other metal objects.
- Do not subject the battery to impacts.

### Cleaning the Battery Terminals

1. Remove the battery. ➤ P. 250
2. If the terminals are starting to corrode and are coated with a white substance, wash with warm water and wipe clean.
3. If the terminals are heavily corroded, clean and polish the terminals with a wire brush or sandpaper. Wear safety glasses.

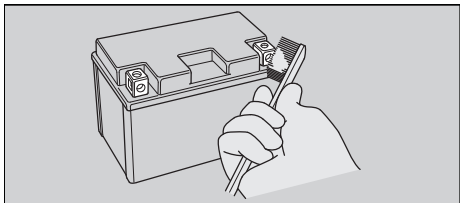

4. After cleaning, reinstall the battery. The battery has a limited life span. Consult your dealer about when you should replace the battery. Always replace the battery with another lithium-ion (li-ion) battery of the same type.

#### NOTICE

Installing non-Honda electrical accessories can overload the electrical system, discharging the battery and possibly damaging the system.

#### Fuses

Fuses protect the electrical circuits on your vehicle. If something electrical on your vehicle stops working, check for and replace any blown fuses. ➤ P. 335

## Inspecting and Replacing Fuses

Turn the ignition switch to the **○** (Off) position to remove and inspect fuses. If a fuse is blown, replace with a fuse of the same rating. For fuse ratings, see "Specifications." ➤ P. 364

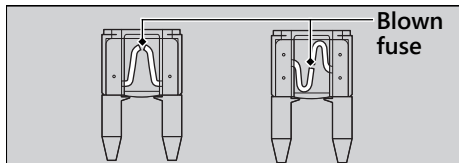

### NOTICE

Replacing a fuse with one that has a higher rating greatly increases the chance of damage to the electrical system.

If a fuse fails repeatedly, you likely have an electrical fault. Have your vehicle inspected by your dealer.

## Engine Oil

Engine oil consumption varies and oil quality deteriorates according to riding conditions and time elapsed.

Check the engine oil level regularly, and add the recommended engine oil if necessary. Dirty oil or old oil should be changed as soon as possible.

## Selecting the Engine Oil

For recommended engine oil, see "Specifications." ➤ P. 363

If you use non-Honda engine oil, check the label to make sure that the oil satisfies all of the following standards:

- JASO T 903 standard\*<sup>1</sup>: MA
- SAE standard\*<sup>2</sup>: 10W-30
- API classification\*<sup>3</sup>: SG or higher

\*<sup>1</sup>. The JASO T 903 standard is an index for engine oils for 4-stroke motorcycle engines. There are two classes: MA and MB. For example, the following label shows the MA classification.

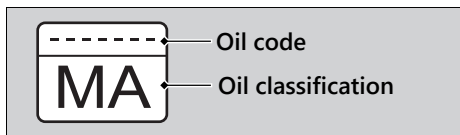

- \*2. The SAE standard grades oils by their viscosity.
- \*3. The API classification specifies the quality and performance rating of engine oils. Use SG or higher oils, excluding oils marked as "Energy Conserving" or "Resource Conserving" on the circular API service symbol.

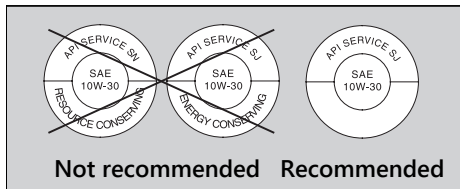

### Brake Fluid

Do not add or replace brake fluid, except in an emergency. Use only fresh brake fluid from a sealed container. If you do add fluid, have the brake system serviced by your dealer as soon as possible.

#### NOTICE

Brake fluid can damage plastic and painted surfaces. Wipe up spills immediately and wash thoroughly.

#### Recommended brake fluid:

Honda DOT 4 Brake Fluid or equivalent



## Drive Chain

The drive chain must be inspected and lubricated regularly. Inspect the chain more frequently if you often ride on bad roads, ride at high speed, or ride with repeated fast acceleration.  P. 273

If the chain does not move smoothly, makes strange noises, has damaged rollers, has loose pins, has missing O-rings, or kinks, have the chain inspected by your dealer.

Also inspect the drive sprocket and driven sprocket. If either has worn or damaged teeth, have the sprocket replaced by your dealer.

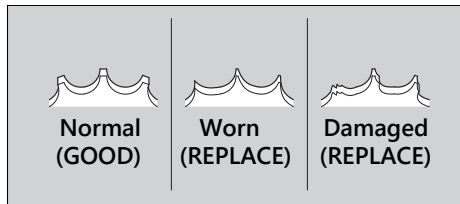

### NOTICE

Use of a new chain with worn sprockets will cause rapid chain wear.

### Cleaning and Lubricating

After inspecting the slack, clean the chain and sprockets while rotating the rear wheel. Use a dry cloth with chain cleaner designed specifically for O-ring chains, or neutral detergent. Use a soft brush if the chain is dirty.

After cleaning, wipe dry and lubricate with the recommended lubricant.

#### Recommended lubricant:

Drive chain lubricant designed specifically for O-ring chains  
If not available, use SAE 80 or 90 gear oil.

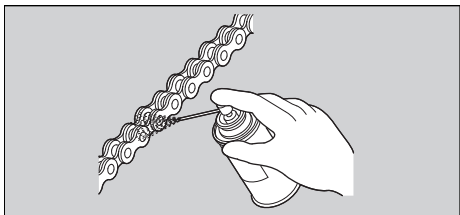

Do not use a steam cleaner, a high pressure cleaner, a wire brush, volatile solvent such as petrol and benzene, abrasive cleaner, chain cleaner or lubricant NOT designed specifically for O-ring chains as these can damage the rubber O-ring seals.

Avoid getting lubricant on the brakes or tyres.  
Avoid applying excess chain lubricant to prevent spray onto your clothes and the vehicle.

### Recommended Coolant

Pro Honda HP Coolant is a pre-mixed solution of antifreeze and distilled water.

#### Concentration:

50% antifreeze and 50% distilled water

A concentration of antifreeze below 40% will not provide proper corrosion and cold temperature protection.

A concentration of up to 60% will provide better protection in colder climates.

#### NOTICE

Using coolant not specified for aluminium engines or tap/mineral water can cause corrosion.

## Crankcase Breathers

Service more frequently when riding in rain, at full throttle, or after the vehicle is washed or overturned. Service if the deposit level can be seen in the transparent section of the drain tube.

If the drain tube overflows, the air filter may become contaminated with engine oil causing poor engine performance. ➔ P. 283

## Tyres (Inspecting/Replacing)

### Checking the Air Pressure

Visually inspect your tyres and use an air pressure gauge to measure the air pressure before each off-road ride and whenever you return to pavement after riding off-road. If you only ride on pavement, check the pressure at least once a month or any time you think the tyres look low. Always check air pressure when your tyres are cold.

If you decide to adjust the tyre pressure for a particular off-road riding condition, make changes a little at a time.

### CRF1100A2/A4/D2/D4

Even if the direction of the valve stem is changed, do not return it to the original position. Have your vehicle inspected by your dealer.

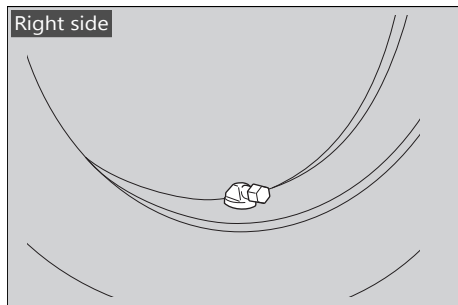

### Inspecting for Damage

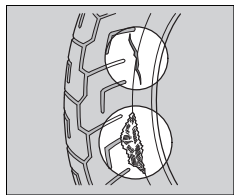

Inspect the tyres for cuts, slits, or cracks that exposes fabric or cords, or nails or other foreign objects embedded in the side of the tyre or the tread.

Also inspect for any unusual bumps or bulges in the side walls of the tyres.

### Inspecting for Abnormal Wear

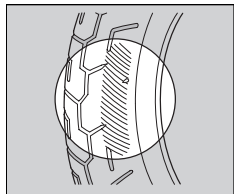

Inspect the tyres for signs of abnormal wear on the contact surface.

### Inspecting Tread Depth

Inspect the tread wear indicators. If they become visible, replace the tyres immediately. For safe riding, you should replace the tyres when the minimum tread depth is reached.

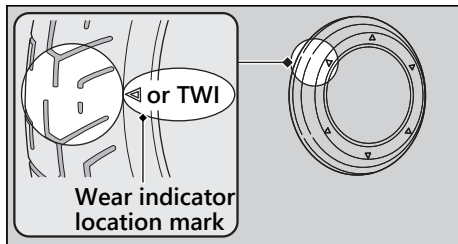

## Inspecting Rims and Valve Stems

Inspect the rims for damage and loose spokes. Also inspect the valve stems for their positions. A tilted valve stem indicates the tube is slipping inside the tyre or the tyre is slipping on the rim. See your dealer.

### **⚠ WARNING**

Riding on tyres that are excessively worn or improperly inflated can cause a crash in which you can be seriously hurt or killed.

Follow all instructions in this owner's manual regarding tyre inflation and maintenance.

#### Germany

German law prohibits use of tyres whose tread depth is less than 1.6 mm.

Have your tyres replaced by your dealer. For recommended tyres, air pressure and minimum tread depth, see "Specifications."

➤ P. 360

Follow these guidelines whenever you replace tyres.

- Use the recommended tyres or equivalents of the same size, construction, speed rating, and load range.
- Have the wheel balanced with Honda Genuine balance weights or equivalent after the tyre is installed.
- **CRF1100A2/A4/D2/D4**  
Do not install a tube inside a tubeless tyre on this vehicle. Excessive heat build-up can cause the tube to burst.
- **CRF1100A2/A4/D2/D4**  
Use only tubeless tyres on this vehicle. The rims are designed for tubeless tyres, and during hard acceleration or braking, a tube-type tyre could slip on the rim and cause the tyre to rapidly deflate.

- Remember to replace the inner tube whenever you replace a tyre. The old tube will probably be stretched, and it could fail if installed in a new tyre.
- If M+S tyres are installed, keep maximum speed to less than 160 km/h (99 mph). The vehicle will not be stable when traveling at speeds of 160 km/h (99 mph) or faster.

### **⚠ WARNING**

Installing improper tyres on your vehicle can adversely affect handling and stability, and can cause a crash in which you can be seriously hurt or killed.

Always use the size and type of tyres recommended in this owner's manual.

### **Air Cleaner**

This vehicle is equipped with a viscous type air cleaner element.

Air blow cleaning or any other cleaning can degrade the viscous element performance and cause the intake of dust.

Do not perform the maintenance. Should be serviced by your dealer.

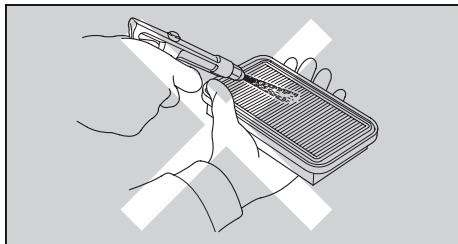

The tool kit is stored in the tool box. ➤ P. 230

You can perform some roadside repairs, minor adjustments and parts replacement with the provided tools.

- Spark plug wrench
- 10 × 14 mm Open end wrench
- 14 × 17 mm Open end wrench
- 19 mm Box end wrench

The helmet set wire is secured with the rear fender under the rear seat. ➤ P. 229

- Helmet set wire

The 5 mm hex wrench, standard/phillips screwdriver, screwdriver handle and fuse puller are located on the underside of the rear seat.

➤ P. 230

- 5 mm Hex wrench
- Standard/Phillips screwdriver
- Screwdriver handle
- Fuse puller

## Battery

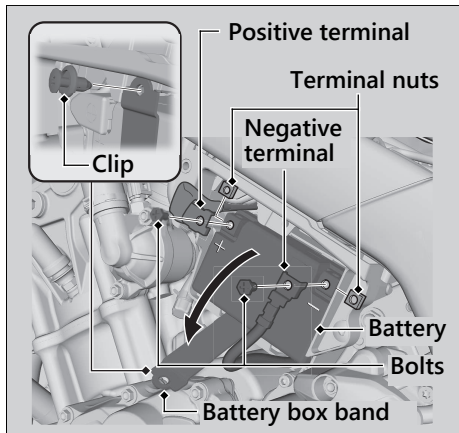

### Removal

Make sure the ignition switch is in the **O** (Off) position.

1. Remove the tool box. ➤ P. 259
2. Disconnect the negative  $\ominus$  terminal from the battery.
3. Disconnect the positive  $\oplus$  terminal from the battery.
4. Remove the clip. ➤ P. 252
5. Open the battery box band.
6. Remove the battery from the battery case taking care not to drop the terminal nuts.

### Installation

Install the parts in the reverse order of removal. Always connect the positive  $\oplus$  terminal first.

Make sure that bolts and nuts are tight. Make sure the clock information is correct after the battery is reconnected. ➤ P. 90



For proper handling of the battery, see "Maintenance Fundamentals." ► P. 239  
"Battery Goes Dead." ► P. 331

## Battery Box Cover

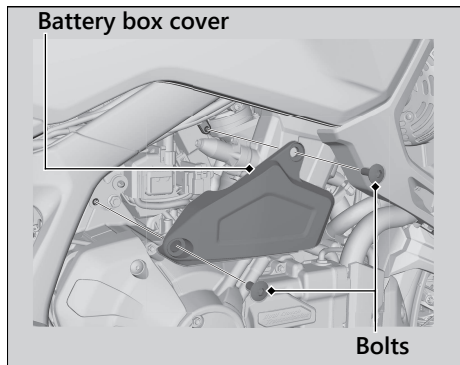

### Removal

1. Remove the bolts using the hex wrench provided on the underside of the rear seat. ► P. 230
2. Remove the battery box cover.

### Installation

Install the parts in the reverse order of removal.

## Clip

### Removal

1. Remove the pin by a Phillips screwdriver.
2. Pull the clip out of the hole.

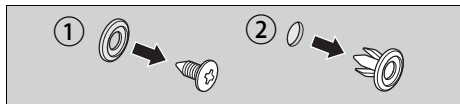

### Installation

1. Insert the clip into the hole.
2. Push the pin in.

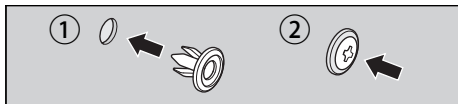

## Front Seat

### Removal

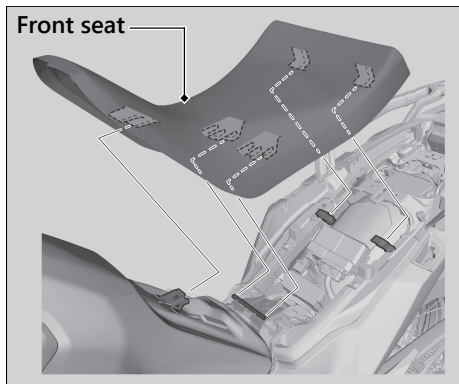

1. Remove the rear seat. ► P. 255
2. Remove the front seat while pulling it backward and upward.

### Installation

1. **When setting the high seat position:**  
Insert the front lower prong and centre lower prongs into the front stay and centre stays on the fuel tank, and insert the rear hooks into the upper slot.
- When setting the low seat position:**  
Insert the front upper prong and centre upper prongs into the front stay and centre stays on the fuel tank, and insert the rear hooks into the lower slot.

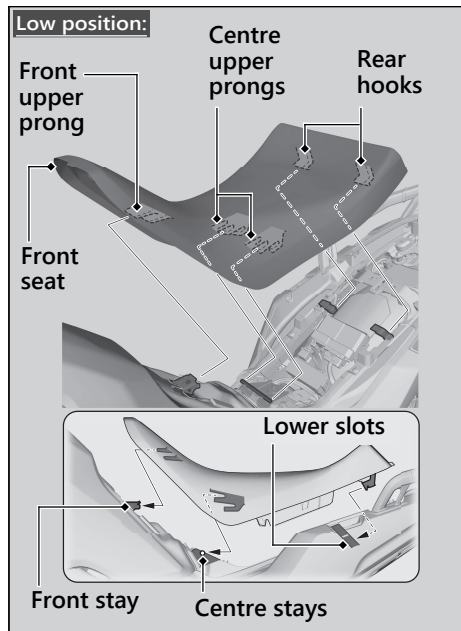
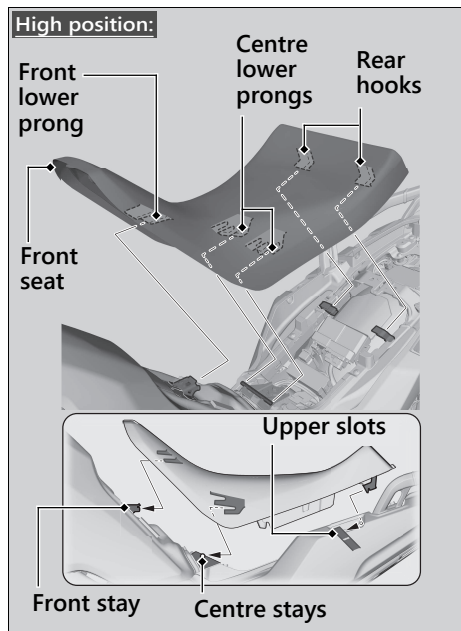

2. Install the front seat while pushing it forward and downward.
  - Make sure that the seat is locked securely in position by pulling it up lightly.

## Rear Seat

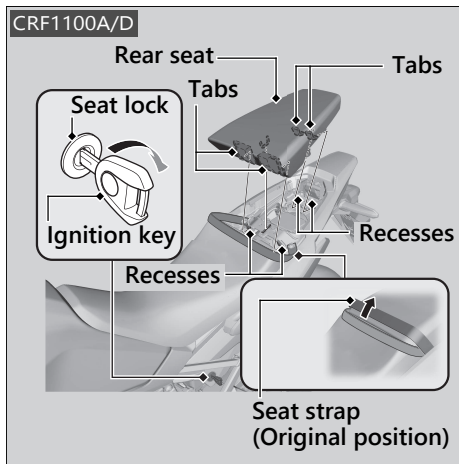

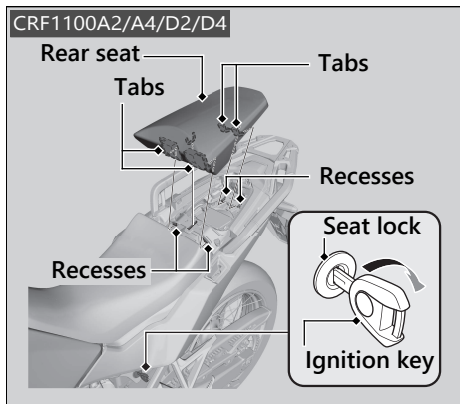

## Removal

- CRF1100A/D**  
Move the seat strap forward.
- Insert the ignition key into the seat lock.
- Turn the ignition key clockwise, then push the rear seat forward and up.

## Installation

- Insert the tabs into the recesses.
- Push down on the front of the rear seat until it locks in place.  
► Make sure that the seat is locked securely in position by pulling it up lightly.
- CRF1100A/D**  
Move the seat strap to its original position.

The seat locks automatically when closed. Take care not to lock your key in the compartment under the rear seat.

## Skid Plate

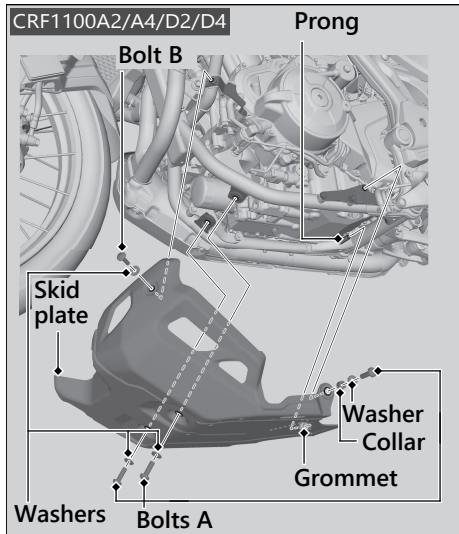
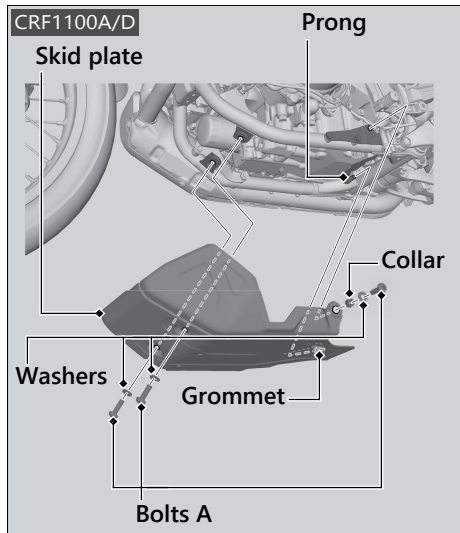

## Removal

1. **CRF1100A/D**  
Remove the bolts A and washers, using the hex wrench provided on the underside of the rear seat. ➤ P. 255
2. **CRF1100A2/A4/D2/D4**  
Remove the bolt B, bolts A and washers, using the hex wrench provided on the underside of the rear seat. ➤ P. 255
3. Remove the collar.
4. Remove the skid plate by releasing its grommet from the prong.

## Installation

1. Install the skid plate in the reverse order of removal.
2. Install the collar.
3. Install the washers onto the bolts A.
4. Tighten the bolts A.

**Torque:** 26 N·m (2.7 kgf·m, 19 lbf·ft).

5. **CRF1100A2/A4/D2/D4**  
Tighten the bolt B.

**Torque:** 12 N·m (1.2 kgf·m, 9 lbf·ft).



## Tool Box

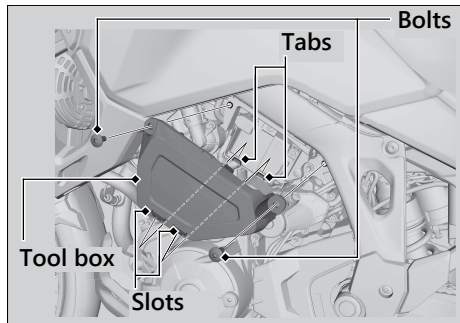

### Removal

1. Remove the bolts using the hex wrench provided on the underside of the rear seat. ► P. 230
2. Remove the tool box by releasing its slots from the tabs.

### Installation

Install the parts in the reverse order of removal.

## Checking the Engine Oil

1. Place your vehicle on its side stand on a firm, level surface.
2. If the engine is cold, idle the engine for 3 to 5 minutes.
3. Turn the ignition switch to the **○** (Off) position and wait for 2 to 3 minutes.
4. Place your vehicle in an upright position on a firm, level surface.
5. Remove the dipstick and wipe it clean.
6. Insert the dipstick until it seats, but don't screw it in.
7. Check that the oil level is between the upper level and lower level marks on the dipstick.
8. Securely install the dipstick.

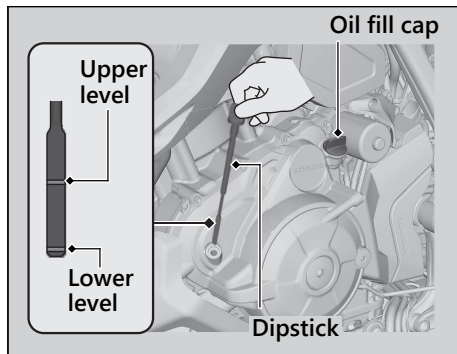

## Adding Engine Oil

---

If the engine oil is below or near the lower level mark, add the recommended engine oil.

► P. 241, ► P. 363

1. Remove the oil fill cap. Add the recommended oil until it reaches the upper level mark.
  - Place your vehicle in an upright position on a firm, level surface when checking the oil level.
  - Do not overfill above the upper level mark.
  - Make sure no foreign objects enter the oil filler opening.
  - Wipe up any spills immediately.

2. Securely reinstall the oil fill cap.

### NOTICE

Overfilling with oil or operating with insufficient oil can cause damage to your engine. Do not mix different brands and grades of oil. They may affect lubrication and clutch operation.

For the recommended oil and oil selection guidelines, see "Maintenance Fundamentals."

► P. 241

## Changing Engine Oil & Filter

Changing the oil and filter requires special tools. We recommend that you have your vehicle serviced by your dealer.

Use a new Honda Genuine oil filter or equivalent specified for your model.

### NOTICE

Using the wrong oil filter can result in serious damage to the engine.

1. Remove the skid plate. ► P. 257
2. If the engine is cold, idle the engine for 3 to 5 minutes.
3. Turn the ignition switch to the **○** (Off) position and wait for 2 to 3 minutes.
4. Place your vehicle on a firm, level surface.
5. Place a drain pan under the drain bolts.

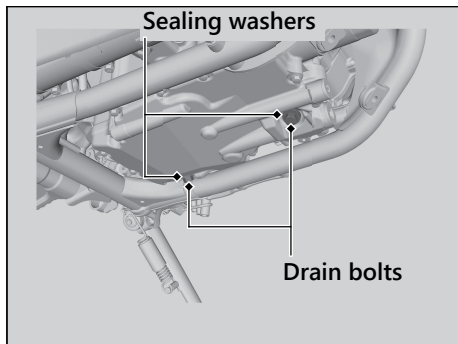

6. Remove the oil fill cap, drain bolts, and sealing washers to drain the oil.
7. Remove the oil filter with a filter wrench and let the remaining oil drain out. Make sure the prior seal is not stuck to the engine.
  - Discard the oil and oil filter at an approved recycling centre.

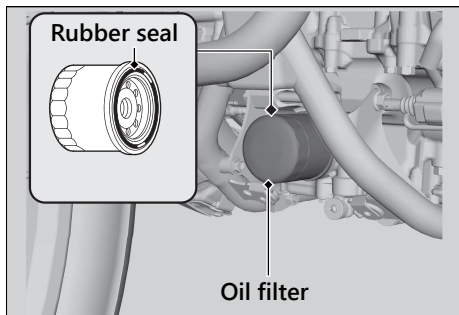

8. Apply a thin coat of engine oil to the rubber seal of a new oil filter.
9. Install the new oil filter and tighten.

**Torque:** 26 N·m (2.7 kgf·m, 19 lbf·ft)

10. Install new sealing washers onto the drain bolts. Tighten the drain bolts.

**Torque:** 30 N·m (3.1 kgf·m, 22 lbf·ft)

11. Fill the crankcase with the recommended oil (► P. 241, ► P. 363) and install the oil fill cap.

### Required oil

#### When changing oil & engine oil filter:

**CRF1100A/A2/A4**

4.0 L (4.2 US qt, 3.5 Imp qt)

**CRF1100D/D2/D4**

4.2 L (4.4 US qt, 3.7 Imp qt)

#### When changing oil only:

**CRF1100A/A2/A4**

3.9 L (4.1 US qt, 3.4 Imp qt)

**CRF1100D/D2/D4**

4.0 L (4.2 US qt, 3.5 Imp qt)

12. Check the oil level. ► P. 260
13. Check that there are no oil leaks.
14. Install the skid plate. ► P. 257

## Changing Clutch Oil Filter

CRF1100D/D2/D4

Use a new Honda Genuine clutch oil filter or equivalent specified for your model.

### NOTICE

Using the wrong clutch oil filter can result in serious damage to the transmission.

1. Follow the steps 1-7 of Changing Engine Oil & Filter. ► P. 262

2. Remove the clutch oil filter cover, clutch oil filter and spring by removing the clutch oil filter cover bolts.  
► Discard the oil and clutch oil filter at an approved recycling centre.

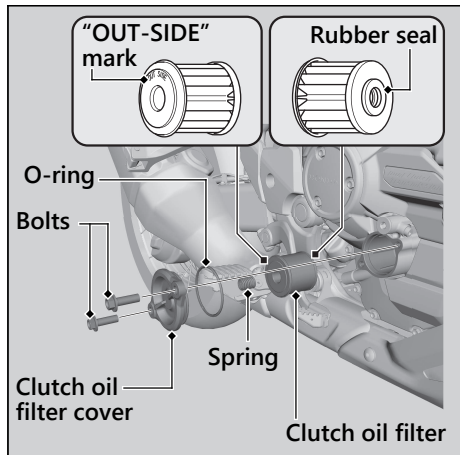

3. Install the new clutch oil filter with the rubber seal facing in, toward the engine. You will see "OUT-SIDE" mark on the clutch oil filter body, toward the filter cover.
4. Replace the O-ring and apply a thin coat of engine oil to the new O-ring when before installing it.
5. Install the spring and the clutch oil filter cover.
6. Install the clutch oil filter cover bolts and tighten.

**Torque:** 12 N·m (1.2 kgf·m, 9 lbf·ft)

7. Apply a thin coat of engine oil to the rubber seal of a new engine oil filter.  
 ➤ P. 263
8. Install a new engine oil filter and tighten.

**Torque:** 26 N·m (2.7 kgf·m, 19 lbf·ft)

9. Install a new sealing washers onto the drain bolts. Tighten the drain bolts.

**Torque:** 30 N·m (3.1 kgf·m, 22 lbf·ft)

10. Fill the crankcase with the recommended oil (➤ P. 241, ➤ P. 363) and install the oil fill cap.

#### Required oil

##### When changing oil, engine oil filter & clutch oil filter:

4.2 L (4.4 US qt, 3.7 Imp qt)

11. Check the oil level. ➤ P. 260
12. Check that there are no oil leaks.
13. Install the skid plate. ➤ P. 257

## Checking the Coolant

Check the coolant level in the reserve tank while the engine is cold.

1. Place your vehicle on a firm, level surface.
2. Hold your vehicle in an upright position.
3. Check that the coolant level is between the UPPER level and LOWER level marks on the reserve tank.

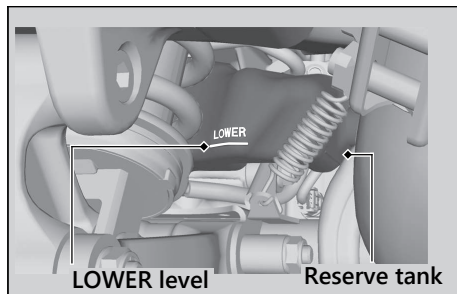
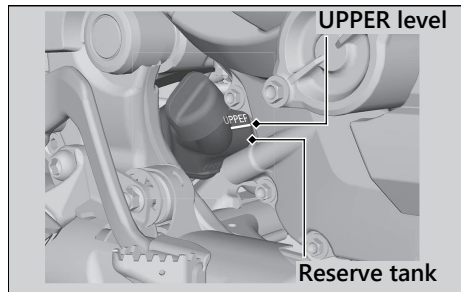

If the coolant level is dropping noticeably or the reserve tank is empty, you likely have a serious leak. Have your vehicle inspected by your dealer.

## Adding Coolant

If the coolant level is below the LOWER level mark, add the recommended coolant (➤ P. 244) until the level reaches the UPPER level mark. Add fluid only from the reserve tank cap and do not remove the radiator cap.



1. Remove the reserve tank cap and add fluid while monitoring the coolant level.
  - Do not overfill above the UPPER level mark.
  - Make sure no foreign objects enter the reserve tank opening.
2. Securely reinstall the reserve tank cap.

## **⚠ WARNING**

Removing the radiator cap while the engine is hot can cause the coolant to spray out, potentially scalding you.

Always let the engine and radiator cool down before removing the radiator cap.

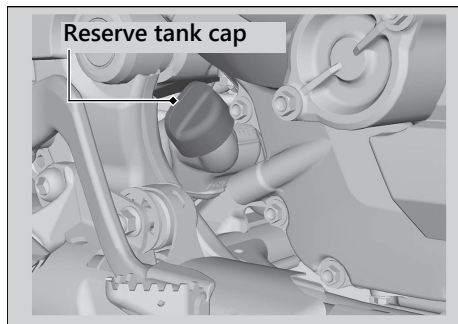

## **Changing Coolant**

Have your dealer change the coolant unless you have the proper tools and are mechanically qualified.

## Checking Brake Fluid

1. Place your vehicle in an upright position on a firm, level surface.
2. **Front** Check that the brake fluid reservoir is horizontal and that the fluid level is above the LOWER level mark.  
**Rear** Check that the brake fluid reservoir is horizontal and that the fluid level is between the LOWER level and UPPER level marks.

If the brake fluid level in either reservoir is below the LOWER level mark or the brake lever and pedal freeplay becomes excessive, inspect the brake pads for wear.

If the brake pads are not worn, you most likely have a leak. Have your vehicle inspected by your dealer.

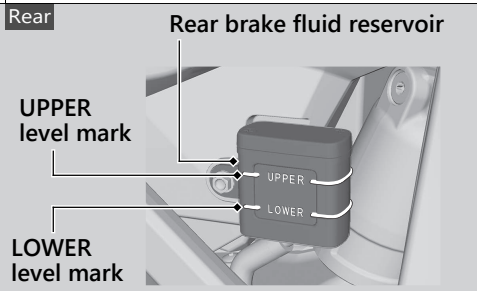
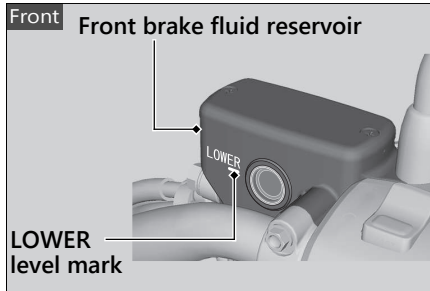

## Inspecting the Brake Pads

Check the condition of the brake pad wear indicators.

**Front** The pads need to be replaced if a brake pad is worn to the bottom of the indicator.

**Rear** The pads need to be replaced if a brake pad is worn to the indicator.

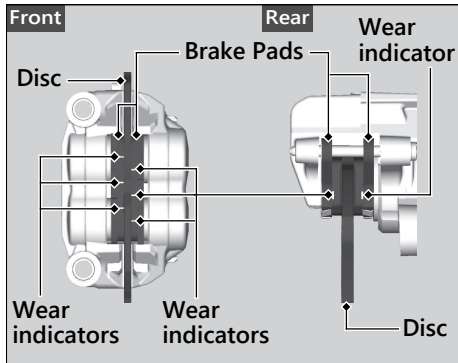

1. **Front** Inspect the brake pads from in front of the brake caliper.
  - Always inspect both left and right brake calipers.
2. **Rear** Inspect the brake pads from the rear right of the vehicle.

If necessary have the pads replaced by your dealer.

Always replace both left and right brake pads at the same time.

## Checking the Parking Brake

CRF1100D/D2/D4

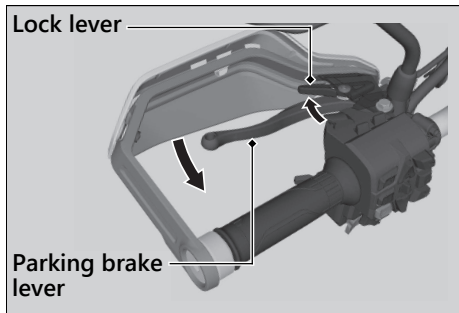

Place your vehicle on a firm, level surface. Stop the engine and push your vehicle while set the parking brake to check the efficacy of the parking brake.

If the efficacy of the parking brake becomes weak, have the brake adjusted by your dealer.

## Adjusting the Brakelight Switch

Check the operation of the brakelight switch. Hold the brakelight switch and turn the adjusting nut in the direction A if the switch operates too late, or turn the nut in the direction B if the switch operates too soon.

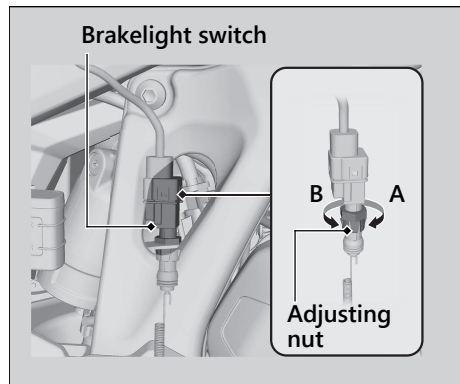

## Checking the Side Stand

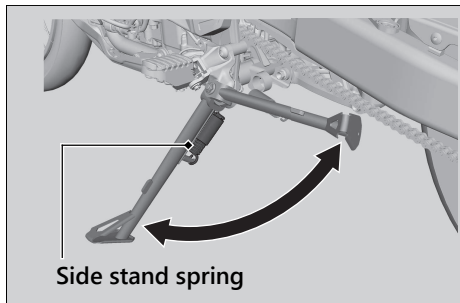

1. Check that the side stand operates smoothly. If the side stand is stiff or squeaky, clean the pivot area and lubricate the pivot bolt with clean grease.
2. Check the spring for damage or loss of tension.

3. **CRF1100A/A2/A4**  
Sit on the vehicle, shift the transmission to Neutral, and raise the side stand.  
**CRF1100D/D2/D4**
4. Sit on the vehicle and raise the side stand.
5. **CRF1100A/A2/A4**  
Start the engine, pull the clutch lever in, and shift the transmission into gear.  
**CRF1100D/D2/D4**  
Start the engine and press the **D-S** side of N-D switch to switch the transmission into D mode.
6. Lower the side stand all the way. The engine should stop as you lower the side stand. If the engine doesn't stop, have your vehicle inspected by your dealer.

## Inspecting the Drive Chain Slack

Check the drive chain slack at several points along the chain. If the slack is not constant at all points, some links may be kinked and binding.

Have the chain inspected by your dealer.

1. Shift the transmission to Neutral. Stop the engine.
2. Place your vehicle on its side stand on a firm, level surface.

3. Check the slack in the lower half of the drive chain midway between the sprockets.

### Drive chain slack:

35 - 45 mm (1.4 - 1.8 in)

- Do not ride your vehicle if the slack exceeds 60 mm (2.4 in).

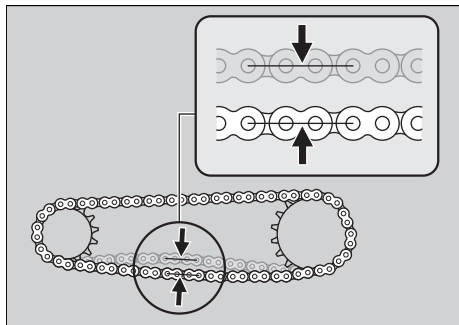

4. Roll the vehicle forward and check that the chain moves smoothly.

5. Inspect the sprockets. 📄 P. 243
6. Clean and lubricate the drive chain.  
📄 P. 243

## Adjusting the Drive Chain Slack

Adjusting the chain requires special tools. Have the drive chain slack adjusted by your dealer.

When adjusting the drive chain slack, be careful not to damage the wheel speed sensor and pulser ring.

1. Shift the transmission to Neutral. Stop the engine.
2. Place your vehicle on its side stand on a firm, level surface.
3. Loosen the rear axle nut.
4. Loosen the lock nuts on both adjusting bolts.

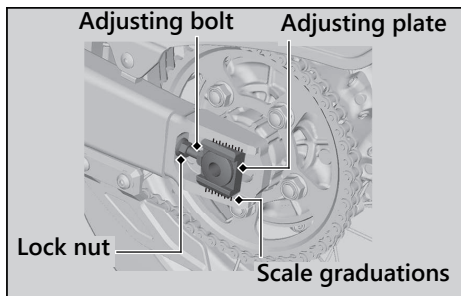
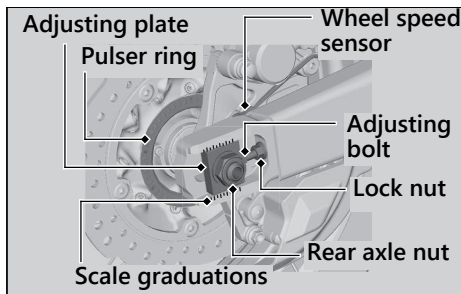



5. Turn both adjusting bolts an equal number of turns until the correct drive chain slack is obtained. Turn the adjusting bolts counterclockwise to tighten the chain. Turn the adjusting bolts clockwise and push the rear wheel toward the front to provide more slack.

Adjust the slack at a point midway between the drive sprocket and the driven sprocket.

Check the drive chain slack.  P. 273

6. Check rear axle alignment by making sure the indicator groove on the chain adjusting plate aligns with the scale graduations on both sides of the swingarm.

Both marks should correspond. If the axle is misaligned, turn the right or left adjusting bolt until the marks are aligned and recheck chain slack.

7. Tighten the rear axle nut.

**Torque:** 100 N·m (10.2 kgf·m, 74 lbf·ft)

8. Hold the adjusting bolts and tighten the lock nuts.

**Torque:** 27 N·m (2.8 kgf·m, 20 lbf·ft)

9. Recheck drive chain slack.

If a torque wrench was not used for installation, see your dealer as soon as possible to verify proper assembly. Improper assembly may lead to loss of braking capacity.

## Checking the Drive Chain Wear

Check the chain wear label when adjusting the drive chain. If the indicator groove on the adjusting plate enters the red zone on the label after the chain has been adjusted to the proper slack, the chain is excessively worn and must be replaced.

**Chain:** DID 525HV3

If necessary have the drive chain replaced by your dealer.

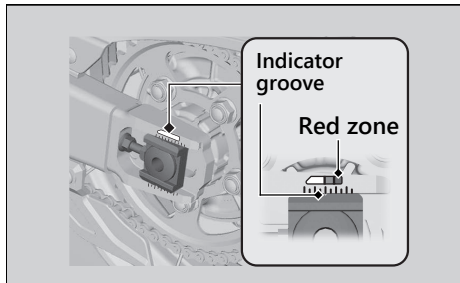

## Checking the Drive Chain Slider

Check the condition of the drive chain slider. The drive chain slider will need to be replaced if the chain slider is worn to the wear limit line. If necessary have the drive chain slider replaced by your dealer.

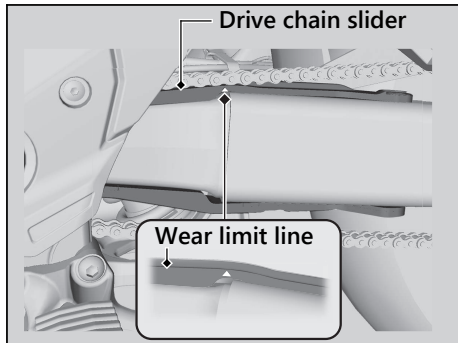

## Wheels Rims & Spokes

---

Keeping the wheels true (round) and maintaining correct spoke tension is critical to safe vehicle operation.

Excessively loose spokes may result in instability at high speeds and possible loss of control.

It is not necessary to remove the wheels to perform the recommended service in the Maintenance Schedule. However, information for wheel removal is provided for emergency situations. 📄 P. 310

1. Inspect the wheel rims and spokes for damage.
2. Tighten any loose spokes.
  - ▶ **CRF1100A2/A4/D2/D4**  
Use the ballpoint hexagon wrench with a length of 140 mm or more.
3. Rotate the wheel slowly to see if it appears to “wobble.” If it does, the rim is out of round or not “true.” If the wobble is noticeable, see your dealer for inspection.

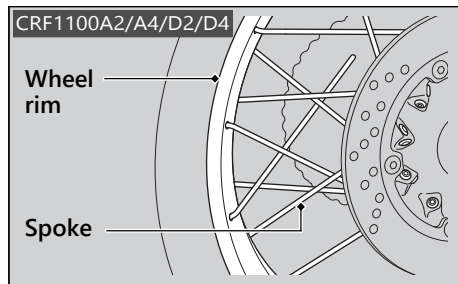
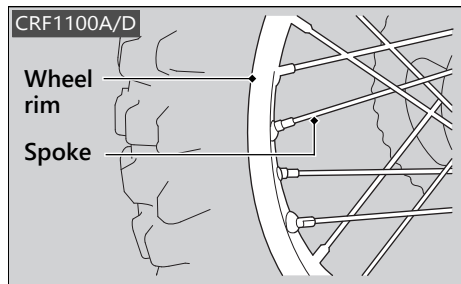

## Checking the Clutch

CRF1100A/A2/A4

### Checking the Clutch Lever Freeplay

Check the clutch lever freeplay.

#### Freeplay at the clutch lever:

10 - 20 mm (0.4 - 0.8 in)

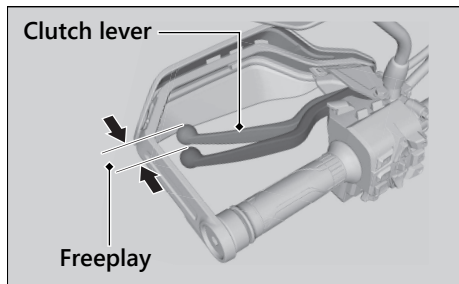

Check the clutch cable for kinks or signs of wear. If necessary have it replaced by your dealer.

Lubricate the clutch cable with a commercially available cable lubricant to prevent premature wear and corrosion.

#### NOTICE

Improper freeplay adjustment can cause premature clutch wear.

## Adjusting the Clutch Lever Freeplay

CRF1100A/A2/A4

### Upper Adjustment

Attempt adjustment with the upper clutch cable adjuster first.

1. Loosen the upper lock nut.
2. Turn the upper clutch cable adjuster until the freeplay is 10 - 20 mm (0.4 - 0.8 in).
3. Tighten the upper lock nut and check the freeplay again.

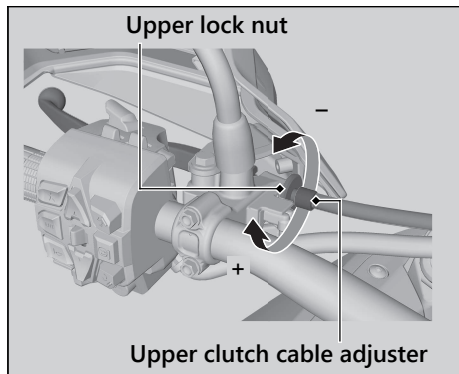

### Lower Adjustment

If the upper clutch cable adjuster is threaded out near its limit, or the correct freeplay cannot be obtained, attempt adjustment with the lower clutch cable adjusting nut.

1. Loosen the upper lock nut and turn the upper clutch cable adjuster all the way in (to provide maximum freeplay). Tighten the upper lock nut.
2. Loosen the lower lock nut.
3. Turn the lower clutch cable adjusting nut until the clutch lever freeplay is 10 - 20 mm (0.4 - 0.8 in).
4. Tighten the lower lock nut and check the clutch lever freeplay.
5. Start the engine, pull the clutch lever in, and shift into gear. Make sure the engine does not stall and the vehicle does not creep. Gradually release the clutch lever and open the throttle. Your vehicle should move smoothly and accelerate gradually.

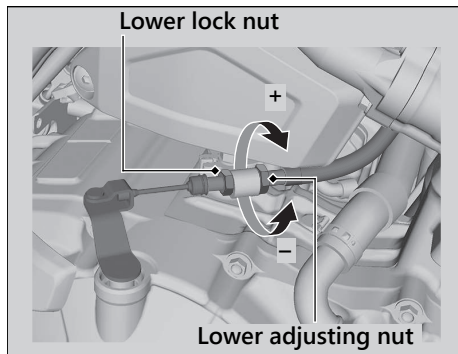

If proper adjustment cannot be obtained or the clutch does not work correctly, see your dealer.

## Checking the Throttle

---

With the engine off, check that the throttle rotates smoothly from fully closed to fully open. If the throttle does not move smoothly, close automatically, have the vehicle inspected by your dealer.

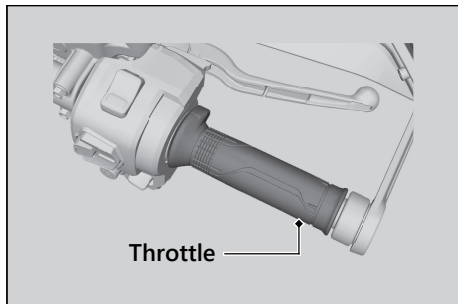



## Cleaning the Crankcase Breather

---

1. Place a suitable container to receive deposits.
2. Remove the crankcase breather tube plugs from the tubes and drain deposits into the container.
3. Reinstall the crankcase breather tube plugs.

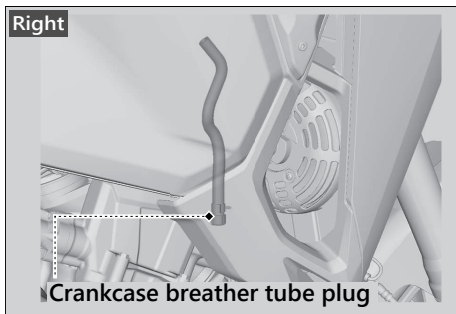
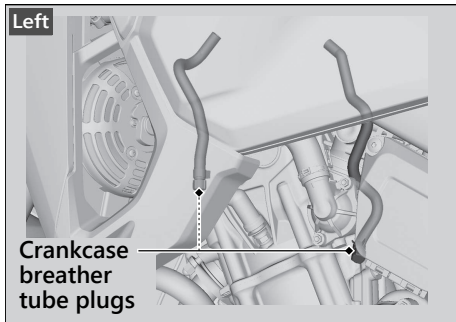

### Adjusting the Headlight Aim

You can adjust vertical aim of the headlight for proper alignment. Turn the knobs in or out as necessary.

Obey local laws and regulations.

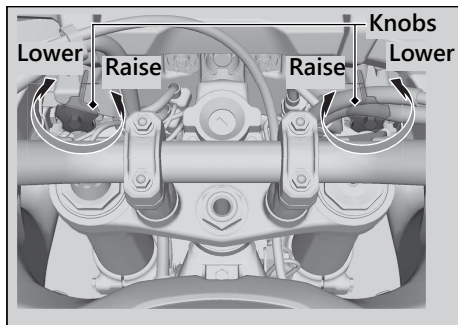

## Adjusting the Brake Lever

You can adjust the distance between the tip of the brake lever and handle grip.

### Adjustment method

Turn the adjuster until the numbers align with the index mark while pushing the lever forward in the desired position. After adjustment, check that the lever operates correctly before riding.

**NOTICE**

Do not turn the adjuster beyond its natural limit.

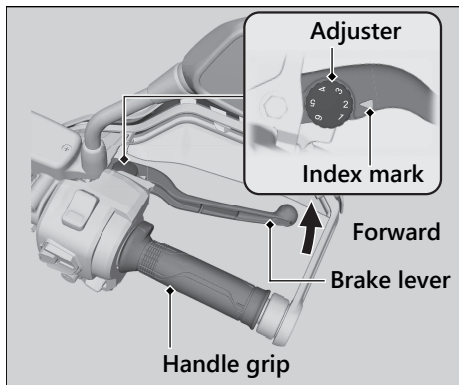

## Adjusting the Front Suspension

### Spring Preload

#### CRF1100A/A2/D/D2

You can adjust the spring preload by the adjuster to suit the load or the road surface. Turn the adjuster using the box end wrench provided in the tool kit. ➔ P. 249

The spring preload adjuster has 15 turns. Turn clockwise to increase spring preload (hard), or turn counterclockwise to decrease spring preload (soft).

#### CRF1100A

The standard position is the 2 turns from the full soft position.

#### CRF1100A2/D

The standard position is the 5 turns from the full soft position.

#### CRF1100D2

The standard position is the 8 turns from the full soft position.

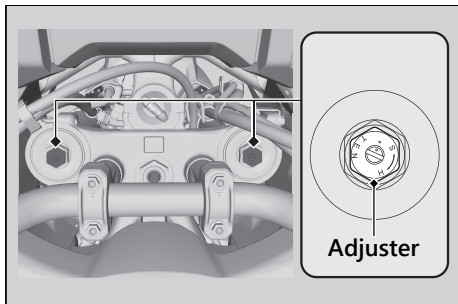

#### NOTICE

Do not turn the adjuster beyond its limits. Adjust both left and right forks to the same spring preload.

## Rebound Damping

### CRF1100A/A2/D/D2

You can adjust the rebound damping by the adjuster to suit the load or the road surface. Turn the adjuster using the Standard/Phillips screwdriver provided on the underside of the rear seat. ➤ P. 230

The rebound damping adjuster has 3 turns or more.

Turn clockwise to increase rebound damping (hard), or turn counterclockwise to decrease rebound damping (soft).

### CRF1100A/D

The standard position is 2 3/4 turns from the maximum setting so that the punch mark on the adjuster aligns with the reference punch mark.

### CRF1100A2/D2

The standard position is 2 1/4 turns from the maximum setting so that the punch mark on the adjuster aligns with the reference punch mark.

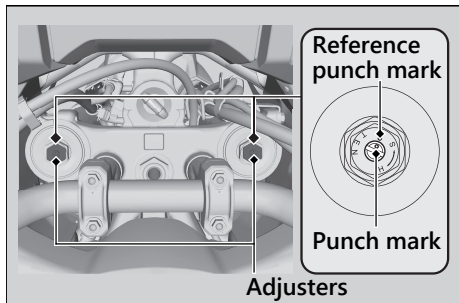

### NOTICE

Do not turn the adjuster beyond its limits. Adjust both left and right forks to the same rebound damping.

## Compression Damping

### CRF1100A/A2/D/D2

You can adjust the compression damping by the adjuster to suit the load or the road surface.

Turn the adjuster using the Standard/Phillips screwdriver provided on the underside of the rear seat. ► P. 230

The compression damping adjuster has 12 position or more.

Turn clockwise to increase compression damping (hard), or turn counterclockwise to decrease compression damping (soft).

### CRF1100A/D

The standard position is 9 clicks from the maximum setting.

### CRF1100A2/D2

The standard position is 7 clicks from the maximum setting.

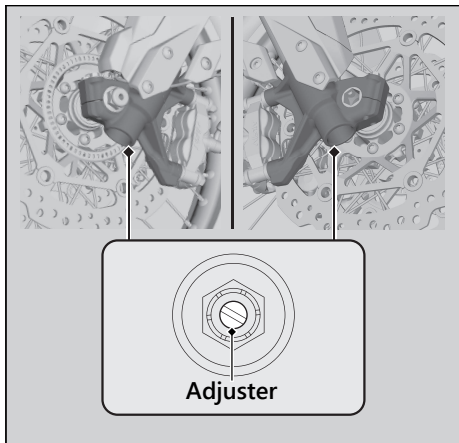

### NOTICE

Do not turn the adjuster beyond its limits. Adjust both left and right forks to the same compression damping.

## Damping

CRF1100A4/D4

- When the riding mode is changed, front suspension damping is automatically selected to a setting corresponding to the riding mode. ➤ P. 148
- You can change the [S] [Overall] and [Front] on the [USER 1 MODE] and [USER 2 MODE] of the riding mode. ➤ P. 76

- **Available setting range:**

[Overall]: [H] Hard / [M] Medium / [S] Soft / [O] Off Road  
[Front]: [-]/[STD]/[+]

- **Default:**

[Overall]  
[USER 1 MODE]: [M] Medium  
[USER 2 MODE]: [S] Soft  
[Front]: [STD]

## Adjusting the Rear Suspension

### Spring Preload

CRF1100A/A2/D/D2

You can adjust the spring preload by the adjuster knob to suit the load or the road surface. The spring preload adjuster has 35 position or more. Turn the clockwise to increase spring preload (high), or turn counterclockwise to decrease spring preload (low).

Turn the adjuster counterclockwise (low) until it will no longer turn (lightly seat). Turn the adjuster clockwise (high) until it clicks. This click is position 0.

The standard position is 7 clicks from the minimum setting.

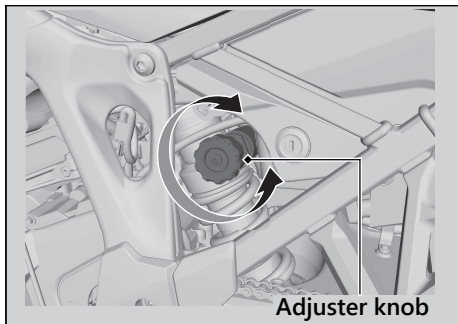

#### NOTICE

Do not turn the adjuster beyond its limits.

#### NOTICE

The rear shock absorber damper unit contains high pressure nitrogen gas. Do not attempt to disassemble, service, or improperly dispose of the damper. See your dealer.



**CRF1100A4/D4**

The electrical adjustable suspension allows the preload of the rear suspension to be adjusted in four levels according to riding and load conditions.

The rear suspension spring preload adjustment can be changed only when your vehicle is stopped.

1. Stop the vehicle.
2. Select the gold image display. ► P. 81
3. Select page 4. ► P. 45
4. Press the **[ENT]** switch.





5. Select [PRELOAD].
6. Push the ◀ or ▶ of the ◀ ▶ sel left/right switch until the desired value is displayed.



7. Press the **[↶]** back switch. You can also perform the above settings by using the touch screen.

## Other Adjustments ▶ Adjusting the Rear Suspension

The rear suspension adjustment provides the following settings.

Status icon	Riding condition
	Rider only (Minimum preload)
	Rider and luggage
	Rider and passenger
	Rider, passenger and luggage (Maximum preload)

**Default:** Rider only

- You can change the [PRELOAD] [Preload] on the [USER 1 MODE] and [USER 2 MODE] of the riding mode. ➡ P. 76

### NOTICE

The rear shock absorber damper unit contains high pressure nitrogen gas. Do not attempt to disassemble, service, or improperly dispose of the damper. See your dealer.

## Rebound Damping

CRF1100A/A2/D/D2

You can adjust the rebound damping by the adjuster to suit the load or the road surface. Turn the adjuster using the Standard/Phillips screwdriver provided on the underside of the rear seat. ► P. 230

Turn clockwise to increase rebound damping (hard), or turn counterclockwise to decrease rebound damping (soft).

The standard position is 8 clicks from the maximum setting so that the punch mark on the adjuster aligns with the reference punch mark.

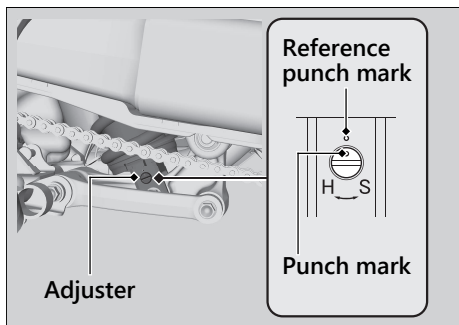

### NOTICE

Do not turn the adjuster beyond its limits.

### NOTICE

The rear shock absorber damper unit contains high pressure nitrogen gas. Do not attempt to disassemble, service, or improperly dispose of the damper. See your dealer.

## Compression Damping

CRF1100A/A2/D/D2

You can adjust the compression damping by the adjuster to suit the load or the road surface.

Turn the adjuster using the Standard/Phillips screwdriver provided on the underside of the rear seat. ► P. 230

Turn clockwise to increase compression damping (hard), or turn counterclockwise to decrease compression damping (soft).

The standard position is 12 from the maximum setting so that the punch mark on the adjuster aligns with the reference punch mark.

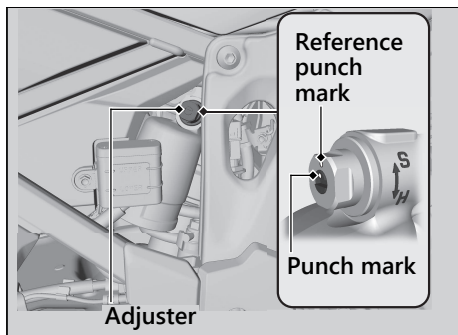

### NOTICE

Do not turn the adjuster beyond its limits.

### NOTICE

The rear shock absorber damper unit contains high pressure nitrogen gas. Do not attempt to disassemble, service, or improperly dispose of the damper. See your dealer.

## I Damping

### CRF1100A4/D4

- When the riding mode is changed, rear suspension damping is automatically selected to a setting corresponding to the riding mode. ➤ P. 148
- You can change the [S] [Overall] and [Rear] on the [USER 1 MODE] and [USER 2 MODE] of the riding mode. ➤ P. 76

- **Available setting range:**

[Overall]: [H] Hard / [M] Medium / [S] Soft / [O] Off Road  
[Rear]: [-]/[STD]/[+]

- **Default:**

[Overall]  
[USER 1 MODE]: [M] Medium  
[USER 2 MODE]: [S] Soft  
[Rear]: [STD]

#### NOTICE

The rear shock absorber damper unit contains high pressure nitrogen gas. Do not attempt to disassemble, service, or improperly dispose of the damper. See your dealer.

## Adjusting the Windscreen Height

CRF1100A2/A4/D2/D4

You can adjust the windscreen height 1 of 5 positions.

Windscreen height indicator shows the windscreen height.

The standard position is 1.

► Do not adjust the windscreen while riding.

1. Push the right and left lock levers to unlock the screen.
2. Continue to push the right and left lock levers, move the right and left lock levers upward or downward to raise or lower the windscreen.

3. Release the right and left lock levers at the desired position while checking height the indicator.  
► Make sure that the windscreen is locked securely by slightly moving the right and left lock levers up or down.

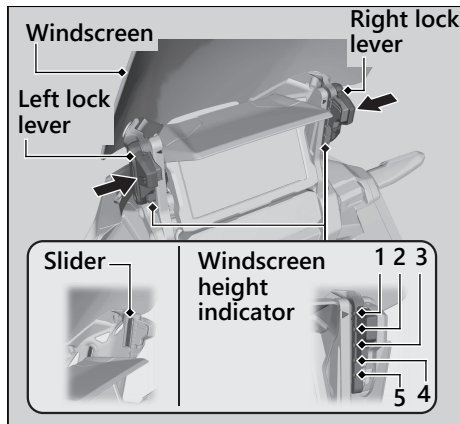

If the windscreen does not move smoothly, clean the sliders using a sponge or a soft towel with neutral detergent to remove dust.

► Do not apply a lubricant to the sliders.

If the windscreen does not move smoothly after cleaning the sliders, have your vehicle inspected by your dealer.

# Troubleshooting



<b>Engine Will Not Start (HISS indicator stays on)</b> .....	P. 299
<b>Overheating (Segment H flashes in coolant temperature gauge)</b> .....	P. 300
<b>Warning Indicators On or Flashing</b> .....	P. 301
Low Oil Pressure Indicator .....	P. 301
PGM-FI (Programmed Fuel Injection) Malfunction Indicator Lamp (MIL).....	P. 302
ABS (Anti-lock Brake System) Indicator .....	P. 303
Torque Control Indicator.....	P. 304
<b>If the “-” Indicator is Blinking in the Gear Position Window While Riding</b> .....	P. 305
<b>Other Warning Indications</b> .....	P. 306
Fuel Gauge Failure Indication.....	P. 306
Coolant Temperature Gauge Failure Indication .....	P. 307
Handle Grip Heater Failure Indication .....	P. 307
<b>Tyre Puncture</b> .....	P. 308
<b>Audio System Trouble</b> .....	P. 318
<b>Electrical Trouble</b> .....	P. 331
Battery Goes Dead.....	P. 331
Burned-out Light Bulb .....	P. 331
Blown Fuse.....	P. 335



### Starter Motor Operates But Engine Does Not Start

---

Check the following items:

- Check the correct engine starting sequence. ➤ P. 206
- Check that there is petrol in the fuel tank.
- Check if the PGM-FI malfunction indicator lamp (MIL) is on.
  - ▶ If the indicator lamp is on, contact your dealer as soon as possible.
- Check if the HISS indicator stays on.
  - ▶ Turn the ignition switch to the  (Off) position and remove the key. Reinsert the key and turn the ignition switch to the  (On) position. If the indicator still stays on, check the following:  
Check if there is no another HISS key (including spare key) close to the ignition switch.

Check if there are no any metallic seals or stickers on the key.

If the HISS indicator still stays on, have your vehicle inspected by your dealer.

### Starter Motor Does Not Operate

---

Check the following items:

- Check the correct engine starting sequence. ➤ P. 206
- Make sure engine stop switch is in the  (Run) position. ➤ P. 116
- Check for a blown fuse. ➤ P. 335
- Check for a loose battery connection (➤ P. 250) or battery terminal corrosion (➤ P. 240).
- Check the condition of the battery. ➤ P. 331

If the problem continues, have your vehicle inspected by your dealer.

## Overheating (Segment H flashes in coolant temperature gauge)

The engine is overheating when the following occurs:

- All segments turn red and the segment H flashes in the coolant temperature gauge.
- Acceleration becomes sluggish.  
If this occurs, pull safely to the side of the road and perform the following procedure.

Extended fast idling may cause the segment H to flash.

### NOTICE

Continuing to ride with an overheated engine can cause serious damage to the engine.

1. Stop the engine using the ignition switch, and then turn the ignition switch to the **I** (On) position.

2. Check that the radiator fan is operating, and then turn the ignition switch to the **O** (Off) position.

### If the fan is not operating:

Suspect a fault. Do not start the engine. Transport your vehicle to your dealer.

### If the fan is operating:

Allow the engine to cool with the ignition switch in the **O** (Off) position.

3. After the engine has cooled, inspect the radiator hose and check if there is a leak.

➔ P. 266

### If there is a leak:

Do not start the engine. Transport your vehicle to your dealer.

4. Check the coolant level in the reserve tank. ➔ P. 266  
▶ Add coolant as necessary.
5. If 1-4 check normal, you may continue riding, but closely monitor the temperature gauge.

## Low Oil Pressure Indicator

---

If the low oil pressure indicator comes on, pull safely to the side of the road and stop the engine.

### NOTICE

Continuing to ride with low oil pressure can cause serious damage to the engine.

1. Check the engine oil level, and add oil as necessary. 📄 P. 260, 📄 P. 261
2. Start the engine.
  - ▶ Only continue riding if the low oil pressure indicator goes off.

Rapid acceleration may momentarily cause the low oil pressure indicator to come on, especially if the oil is at or near the low level. If the low oil pressure indicator stays on when the oil level is at the proper level, stop the engine and contact your dealer.

If the engine oil level goes down rapidly, your vehicle may have a leak or another serious problem. Have your vehicle inspected by your dealer.

## PGM-FI (Programmed Fuel Injection) Malfunction Indicator Lamp (MIL)

---

### Reasons for the indicator lamp to come on or blink

- Comes on if there is a problem with the engine emissions control system.
- Blinks when engine misfiring is detected.

### What to do when the indicator lamp comes on

Avoid high speeds and immediately get your vehicle inspected at a dealer.

### What to do when the indicator lamp blinks

Park the vehicle in a safe place with no flammable items and wait at least 10 minutes with the engine stopped until it cools.

#### NOTICE

If you drive with the malfunction indicator lamp on, the emissions control system and the engine could be damaged.

#### NOTICE

If the malfunction indicator lamp blinks again when restarting the engine, drive to the nearest dealer at 50 km/h (31 mph) or less. Have your vehicle inspected.

## ABS (Anti-lock Brake System) Indicator

---

If the indicator operates in one of the following ways, you may have a serious problem with the ABS. Reduce your speed and have your vehicle inspected by your dealer as soon as possible.

- Indicator comes on or starts flashing while riding.
- Indicator does not come on when the ignition switch is in the **I** (On) position.
- Indicator does not go off at speeds above 10 km/h (6 mph).

If the ABS indicator stays on, your brakes will continue to work as a conventional system, but without the anti-locking function.

The ABS indicator may flash if you turn the rear wheel while the rear wheel is lifted off the ground. In this case, turn the ignition switch to the **O** (Off) position, and then to the **I** (On) position again. The ABS indicator will go off after your speed reaches 30 km/h (19 mph).

## Torque Control Indicator

---

If the indicator operates in one of the following ways, you may have a serious problem with the Torque Control. Reduce your speed and have your vehicle inspected by your dealer as soon as possible.

- Indicator comes and stays on (solid) while riding.
- Indicator does not come on when the ignition switch is turned to the **I** (On) position.
- Indicator does not go off at speeds above 5 km/h (3 mph).

Even when the Torque Control indicator is on, your vehicle will have normal riding ability without Torque Control function.

- When the indicator comes on while the Torque Control is in operation, you will have to completely close the throttle to regain normal riding ability.



The Torque Control indicator may come on if you rotate the rear wheel while your vehicle is lifted off the ground. In this case, turn the ignition switch to the **O** (Off) position, and then to the **I** (On) position again. The Torque Control indicator will go off after your speed reaches 5 km/h (3 mph).

## If the “-” Indicator is Blinking in the Gear Position Window While Riding

### CRF1100D/D2/D4

If the “-” indicator is blinking while riding, you may have a serious problem with the Dual Clutch Transmission system.

Park your vehicle in a safe place and have your vehicle inspected by dealer immediately. It may be possible to ride your vehicle by following the steps below.

1. Turn the ignition switch to the  (Off) position.
2. Turn the ignition switch to the  (On) position and start the engine.

### If you cannot start the engine:

Turn the ignition switch to the  (Off) position and move the vehicle back and forth slightly (to disengage the gears).

Turn the ignition switch to the  (On) position again and start the engine.

### If you still cannot start the engine:

Start the engine while applying the brake lever or pressing the brake pedal.

### If you can shift from N to D mode:

When a gear position is shown in the gear position indicator, you can ride in that gear. Take your vehicle to your dealer riding at a safe speed.

### If you can't shift from N to D mode and the “-” indicator is blinking:

Damage is preventing you from riding. Have your vehicle inspected by your dealer immediately.

### Fuel Gauge Failure Indication

If the fuel system has an error, all segments will blink as shown in the illustration.

If these occur, see your dealer as soon as possible.

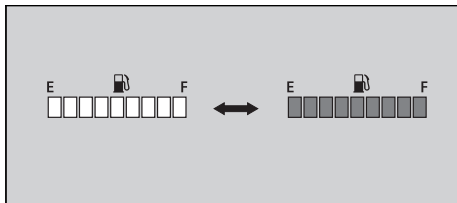



## Coolant Temperature Gauge Failure Indication

If the cooling system has an error, all segments will blink as shown in the illustration.

If this occurs, see your dealer as soon as possible.

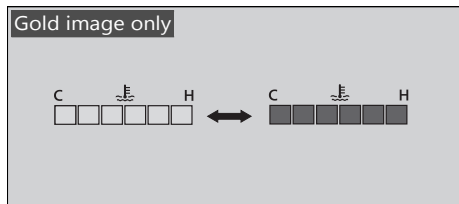

## Handle Grip Heater Failure Indication

CRF1100A2/A4/D2/D4

If the handle grip heater system has an error, the handle grip heater status icon will blink. If these occur, see your dealer as soon as possible.

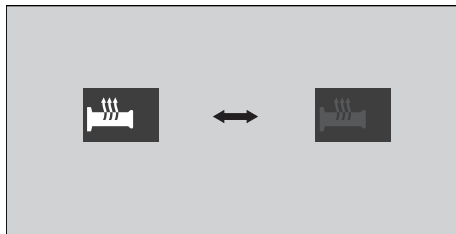

## Tyre Puncture

Repairing a puncture or removing a wheel requires special tools and technical expertise. We recommend you have this type of service performed by your dealer.

After an emergency repair, always have the tyre inspected/replaced by your dealer.

### Emergency Repair Using a Tyre Repair Kit

CRF1100A2/A4/D2/D4

If your tyre has a minor puncture, you can make an emergency repair using a tubeless tyre repair kit.

Follow the instructions provided with the emergency tyre repair kit.

Riding your vehicle with a temporary tyre repair is very risky. Do not exceed 50 km/h (30 mph). Have the tyre replaced by your dealer as soon as possible.

### **WARNING**

Riding your vehicle with a temporary tyre repair can be risky. If the temporary repair fails, you can crash and be seriously injured or killed.

If you must ride with a temporary tyre repair, ride slowly and carefully and do not exceed 50 km/h (30 mph) until the tyre is replaced.

## Tube Repair and Replacement

---

### CRF1100A/D

If a tube is punctured or damaged, you should replace it as soon as possible. A tube that is repaired may not have the same reliability as a new one, and it may fail while you are riding.

If you need to make a temporary repair by patching a tube or using an aerosol sealant, ride cautiously at reduced speed and have the tube replaced before you ride again.

Anytime a tube is replaced, the tyre should be carefully inspected as described.

### **WARNING**

Riding your vehicle with a temporary tyre or tube repair can be risky. If the temporary repair fails, you can crash and be seriously injured or killed.

If you must ride with a temporary tyre or tube repair, ride slowly and carefully and do not exceed 50 km/h (30 mph) until the tyre or tube is replaced.

## Removing Wheels

Follow these procedures if you need to remove a wheel in order to repair a puncture.

When removing and installing the wheel, be careful not to damage the wheel speed sensor and pulser ring.

### Front Wheel

#### Removal

1. Place your vehicle on a firm, level surface.

2. Cover both sides of the front wheel, spoke and brake caliper with protective tape or cloth.

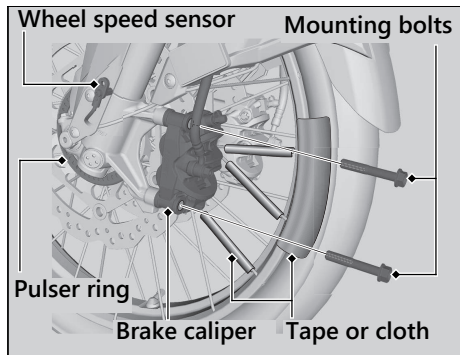

3. On the left side, remove the mounting bolts and remove the brake caliper.

4. On the right side, remove the mounting bolts and remove the brake caliper.
  - Support the brake caliper assembly so that it doesn't hang from the brake hose. Do not twist the brake hose.
  - Avoid getting grease, oil, or dirt on the disc or pad surfaces.
  - Do not pull the brake lever while the brake caliper is removed.
  - Take care to prevent the brake caliper from scratching the wheel during removal.

5. Remove the front axle nut cap.
6. Remove the front axle nut.
7. Loosen the left axle pinch bolts.
8. Support your vehicle securely and raise the front wheel off the ground using a maintenance stand or a hoist.

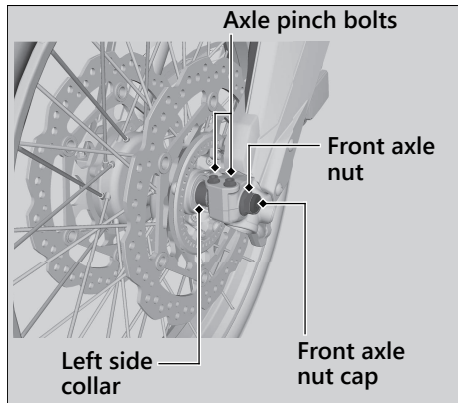

9. Loosen the right axle pinch bolts.
10. On the right side, loosen and withdraw the front axle shaft, and remove the side collars and wheel.

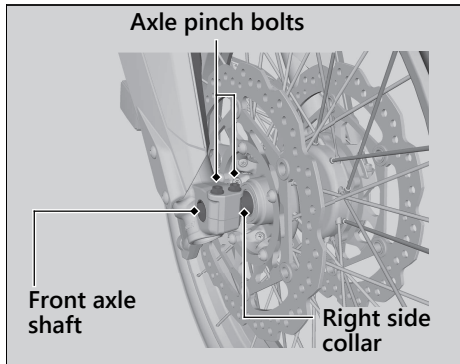

## Installation

1. Attach the side collars to the wheel.
2. On the right side, place the wheel between the fork legs and insert the lightly greased front axle shaft to the end, through the right fork leg and wheel hub.
3. Align the end of the front axle shaft with the surface of the fork leg.

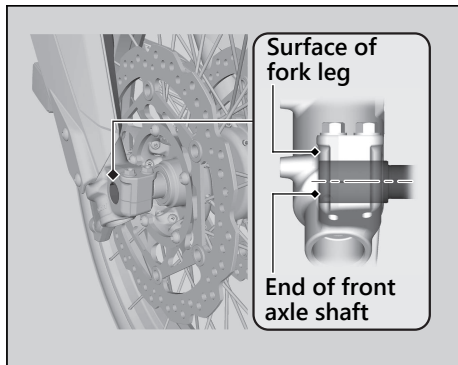

4. Tighten the right axle pinch bolts to hold the axle.
5. Tighten the axle nut.

**Torque:** 65 N·m (6.6 kgf·m, 48 lbf·ft).

6. Loosen the right axle pinch bolts.
7. Tighten the left axle pinch bolts.

**Torque:** 22 N·m (2.2 kgf·m, 16 lbf·ft).

8. Install the right brake caliper and tighten new mounting bolts.

**Torque:** 45 N·m (4.6 kgf·m, 33 lbf·ft).

9. Install the left brake caliper and tighten new mounting bolts.

**Torque:** 45 N·m (4.6 kgf·m, 33 lbf·ft).

- Take care to prevent the brake caliper from scratching the wheel during installation.
- Use new mounting bolts when installing the brake caliper.

**NOTICE**

When installing a wheel or caliper into original position, carefully fit the brake disc between the pads to avoid scratching them.

10. Lower the front wheel on the ground.
11. Apply the brake lever several times. Then, pump the fork several times.
12. Retighten the right axle pinch bolts.

**Torque:** 22 N·m (2.2 kgf·m, 16 lbf·ft).

13. Raise the front wheel off the ground again, and check that the wheel rotates freely after you release the brake.
14. Install the front axle nut cap.
15. Remove the protective tape or cloth.

If a torque wrench was not used for installation, see your dealer as soon as possible to verify proper assembly. Improper assembly may lead to loss of braking capacity.

## Rear Wheel

### Removal

1. Support your vehicle securely and raise the rear wheel off the ground using a maintenance stand or a hoist.
2. **CRF1100D/D2/D4**  
Release the parking brake. ➤ P. 129

3. **CRF1100A/A2/A4**

Cover both sides of the rear wheel, spoke and brake caliper with protective tape or cloth.

- CRF1100D/D2/D4**

Cover both sides of the rear wheel, spoke and brake calipers with protective tape or cloth.

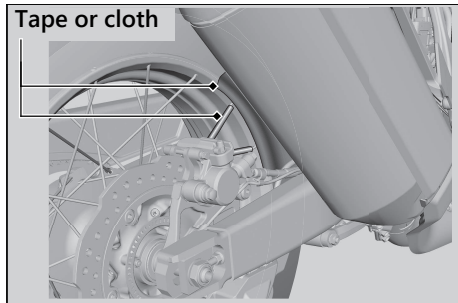



4. Remove the bolts using the hex wrench provided on the underside of the rear seat.  P. 230
5. Remove the chain cover.

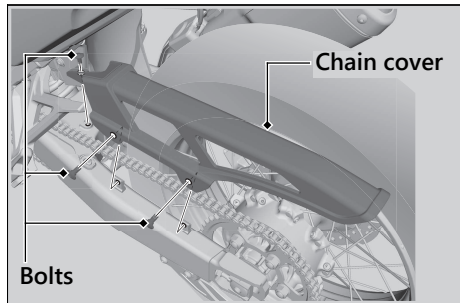

6. Loosen the rear axle nut, lock nuts and turn the adjusting bolts so the rear wheel can be moved all the way forward for maximum drive chain slack.
7. Remove the rear axle nut and washer.

8. Remove the drive chain from the driven sprocket by pushing the rear wheel forward.
9. Remove the rear axle shaft and adjusting plates.

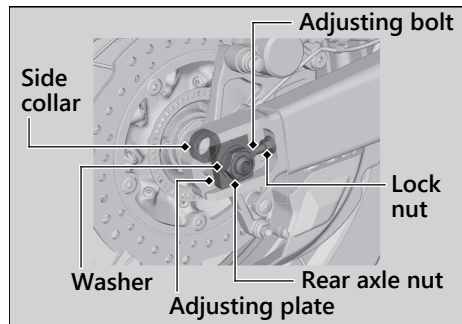

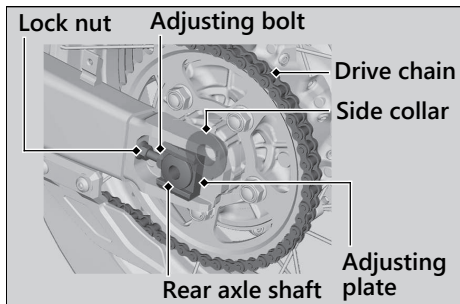

10. Remove the rear wheel and side collars.
- Avoid getting grease, oil, or dirt on the disc or pad surfaces.
  - Do not push the brake pedal while the wheel is removed.
  - **CRF1100D/D2/D4**  
Do not set the parking brake while the wheel is removed.

## Installation

1. To install the rear wheel, reverse the removal procedure.
- Take care to prevent the brake caliper from scratching the wheel during installation.

### NOTICE

When installing a wheel or caliper into original position, carefully fit the brake disc between the pads to avoid scratching them.

2. Make sure that the slot on the brake caliper bracket is positioned in the lug on the swingarm.

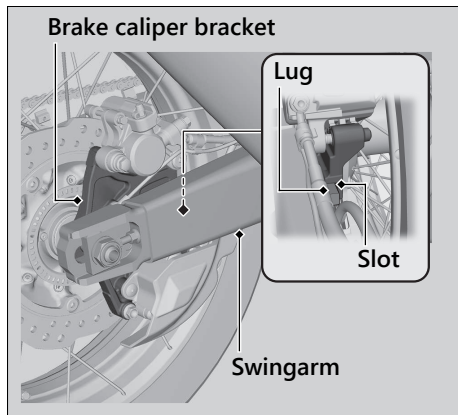

3. Adjust the drive chain. ► P. 274
4. Install and tighten the rear axle nut.

**Torque:** 100 N·m (10.2 kgf·m, 74 lbf·ft).

5. Install the chain cover and tighten bolts.
6. After installing the wheel, apply the brake pedal several times, then check if the wheel rotates freely. Recheck the wheel if the brake drags or if the wheel does not rotate freely.

If a torque wrench was not used for installation, see your dealer as soon as possible to verify proper assembly. Improper assembly may lead to loss of braking capacity.

Symptom	Cause/remedy
Unable to pair <i>Bluetooth</i> ® device	Some <i>Bluetooth</i> ® devices and application software you use may be incompatible with the audio system and/or the operable functions may be limited.
	Check that the audio system and <i>Bluetooth</i> ® device are both in pairing mode. ➤ P. 160 ➤ P. 165
	The audio system may not be properly connected when another <i>Bluetooth</i> ® device is being paired at the same time. Check your surroundings to make sure no other device being paired is present before re-pairing. Presence of a <i>Bluetooth</i> ® device in the vicinity sometimes affects the pairing due to radio wave interference, etc.
	When connecting a <i>Bluetooth</i> ® device, make sure no other <i>Bluetooth</i> ® device readied for pairing is present. Presence of a <i>Bluetooth</i> ® device in the vicinity sometimes affects the pairing due to radio wave interference, etc.
	When you repeatedly fail in pairing, delete the paired device once, then try pairing again. ➤ P. 160 ➤ P. 165

<b>Symptom</b>	<b>Cause/remedy</b>
Unable to connect <i>Bluetooth</i> ® device	<p>Depending on the <i>Bluetooth</i>® device and application software you use, it may take some time for the audio system to connect to a device and to start playing an audio file.</p> <p>The connection may be temporarily disconnected when starting the engine, which is normal and not a malfunction. The <i>Bluetooth</i>® device will be reconnected after the engine is started.</p> <p>Check that your <i>Bluetooth</i>® device has been paired. Refer to the instruction manual of your <i>Bluetooth</i>® device and check that your <i>Bluetooth</i>® device is in connectable state.</p>

Symptom	Cause/remedy
Unable to connect <i>Bluetooth</i> ® phone device	Some <i>Bluetooth</i> ® devices and application software you use may not connect automatically. For connecting, follow the instructions in the instruction manual of your <i>Bluetooth</i> ® device.
	The <i>Bluetooth</i> ® devices that can be connected at the same time are limited to one <i>Bluetooth</i> ® device and two <i>Bluetooth</i> ® headsets.
	If the problem continues after the above-described inspection, delete the paired device once, then try pairing again. ➤ P. 160 ➤ P. 165
	The <i>Bluetooth</i> ® connection cannot be established while launching Apple CarPlay. Quit Apple CarPlay, then try pairing again. ➤ P. 197 ➤ P. 160
	While connected to Apple CarPlay, <i>Bluetooth</i> ® function is disabled.

Symptom	Cause/remedy
Connected, but does not play.	<p>Some <i>Bluetooth</i>® devices and application software you use may be incompatible with the audio system and/or audio files may not be played properly. Check the recommended specifications.  <b>➤</b> P. 159</p> <p>Depending on the <i>Bluetooth</i>® device and application software you use, an audio file may not play automatically. For playing, follow the instructions in the instruction manual of your <i>Bluetooth</i>® device.</p> <p>Depending on the <i>Bluetooth</i>® device and application software you use, an audio file may not play normally after receiving a telephone call, etc. Check that your <i>Bluetooth</i>® device is in playable state.</p>
Takes some time to start playing after turning the power on or changing the audio mode.	Right after the power is turned on or the audio mode is changed, the audio system may take some time to connect to an audio device and to start playing an audio file. Also, the audio system may not allow any audio control operation while preparing to play an audio file.

## Audio System Trouble

<b>Symptom</b>	<b>Cause/remedy</b>
Sounds skip Noises mix	<p>Presence of another <i>Bluetooth</i>® device or a device that emits electromagnetic waves such as communication equipment in the vicinity sometimes affects the communication.</p> <p>Due to the characteristics of <i>Bluetooth</i>®, though in rare cases, the system operation may become unstable. When it remains unstable, turn off the power to the audio system or the device being used, and then turn it on again.</p> <p>The storage location of the <i>Bluetooth</i>® device sometimes affects the audio system and communication. When sounds skip or noises mix, change the location of the device. For example, when the device is kept in a pocket of clothing sandwiched in between the rider and passenger, the communication may be affected. Also, weather, buildings in the vicinity, road conditions, etc. can sometimes affect the communication.</p>



<b>Symptom</b>	<b>Cause/remedy</b>
Sounds skip Noises mix	Depending on the <i>Bluetooth</i> ® device and application software you use, an audio file may not play normally after receiving a telephone call, etc. Turn off the power to the audio system and then turn it on again. If the skipping of sounds or mixing of noises continues, check the status of your <i>Bluetooth</i> ® device.
	If the skipping of sounds or mixing of noises continues, delete the paired device once, then try pairing again. ➔ P. 168
	Check the recommended specifications. ➔ P. 159
	Noise sometimes mixes at places where radio waves are weak.

## Audio System Trouble

<b>Symptom</b>	<b>Cause/remedy</b>
Audio volume from headset is low/high.	Adjust the volume while in the individual modes. ➤ P. 95
	Check the volume setting of the <i>Bluetooth</i> ® audio device.
	Check the volume setting of the paired headset.
No or inaccurate display	Depending on the audio device and the audio file, nothing may be displayed or the display may be inaccurate in some cases. Check the information on available tags. ➤ P. 177
	When the information in an audio file such as the artist name and track title is in a non-compliant tag format, it may be indicated by "☒" or no information will be shown.



<b>Symptom</b>	<b>Cause/remedy</b>
<i>Bluetooth</i> ® handsfree calling cannot be available.	<p>Connected <i>Bluetooth</i>® device may be an unsupported device. Check the supported <i>Bluetooth</i>® version/profiles. ➤ P. 159</p> <p>When the <i>Bluetooth</i>® connection is unstable due to surrounding conditions or radio wave conditions, the handsfree calling functions may not be available.</p> <p>To use <i>Bluetooth</i>® handsfree calling, a headset connection is necessary. Connect a paired headset. ➤ P. 165</p>
During a call, headset volume is low/high.	Adjust the volume during a call. ➤ P. 95
Passenger's headset is no sound	Passenger headset only outputs music. Music playback is interrupted while using the handsfree phone or Siri.

## Audio System Trouble

<b>Symptom</b>	<b>Cause/remedy</b>
<i>Bluetooth</i> ® Handsfree Calling	Depending on the connection status, the times displayed in call history on the vehicle side or the phone side may differ.
	Depending on your mobile carrier plan, available functions may differ.
	A display delay may occur depending on the number of phone books, call history and music data etc. stored in the connected device.

<b>Symptom</b>	<b>Cause/remedy</b>
Apple CarPlay is not be available.	Connected iPhone may be an unsupported model. Check the models compatible with Apple CarPlay. ➤ P. 192
	Connected iPhone may be an unsupported iOS version. Update the iPhone to the newer version.
	To use Apple CarPlay, a headset connection is necessary. Connect a paired headset. ➤ P. 165
	When a mobile network communication is unstable due to surrounding conditions or signal strength conditions, Apple CarPlay functions may not be available.

Symptom	Cause/remedy
<p>Apple CarPlay is not be available.</p>	<p>When the paired headset connection is broken due to headset battery depletion or communication failure, Apple CarPlay cannot be used until the connection is restored.</p>
	<p>The screen will not switch to Apple CarPlay automatically, other than when the ignition switch is turned to  (Off) with Apple CarPlay activated.</p>
	<p>Some USB cables may be incompatible with Apple CarPlay. Use certified cable to connect the iPhone.</p>
	<p>You have not agreed to enable Apple CarPlay. Reconnect the iPhone and enable CarPlay on the disclaimer screen. ➤ P. 195</p>
	<p>Apple CarPlay setting on your iPhone may be disabled. Disconnect iPhone and enable the Apple CarPlay setting on your iPhone.</p>

<b>Symptom</b>	<b>Cause/remedy</b>
Connected, but does not operate Apply CarPlay.	You cannot operate Apple CarPlay by the touch panel while the vehicle is in motion. Operate with the left handlebar switches or park your vehicle in a safe place, then operate.
Some functions of Apple CarPlay not available.	Some functions may be limited due to condition of mobile network communication.
Apple CarPlay screen is too dark/bright	Selecting [Background] menu in [Settings], you can select white mode or black mode in the navigation map or an application such as Maps, also adjust backlight brightness by [Brightness] menu in [Settings] ➤ P. 84 ➤ P. 83.
Audio system cannot operate.	Certain manual functions and settings are disabled or inoperable while the vehicle is in motion. You cannot select a greyed-out menu until the vehicle is stopped.
When turning the ignition switch to  (Off) and  (On) continuously.	Since the system restart takes time, it may take time until the screen is appeared.

## Audio System Trouble

<b>Symptom</b>	<b>Cause/remedy</b>
High temperature/ overcurrent protection	To protect the system, some operations may be limited temporarily. The system automatically recovers after the cause is solved.
Software update	The statements in this owner's manual may not match your vehicle's Audio System after performing the software update.

If the problem continues after the above-described inspection, have your vehicle inspected by your dealer.



### Battery Goes Dead

---

Battery charging is needed.

A battery charger recommended by your lithium-ion (li-ion) battery manufacturer is needed for battery charging.

Contact your dealer before charging the battery.

Remove the battery from the vehicle before charging.

#### NOTICE

Only use a charger recommended by your lithium-ion (li-ion) battery manufacturer. Using a battery charger that is not recommended can cause permanent damage to your battery.

If the battery does not recover after recharging, contact your dealer.



#### NOTICE

Do not jump-start, as this can damage your vehicle's electrical system and battery.

### Burned-out Light Bulb

---

All light bulbs on the vehicle are LEDs. If there is an LED which is not turned on, see your dealer for servicing.

Turn the ignition switch to the  (Off) or  (Lock) position.

## | Headlight

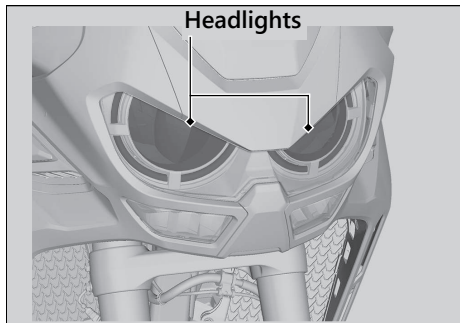

The headlights use several LEDs.  
If there is a LED which is not turned on, see  
your dealer for this service.

## | DRL

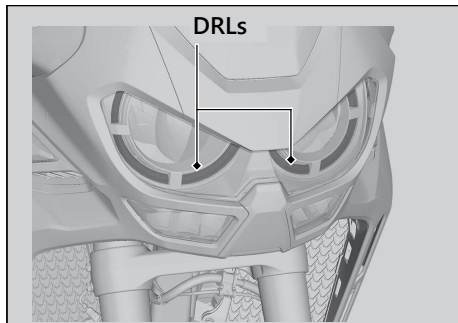

The DRLs use several LEDs.  
If there is a LED which is not turned on, see  
your dealer for this service.

## Cornering Light

CRF1100A2/A4/D2/D4

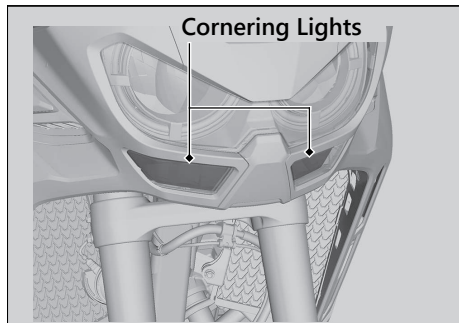

The cornering lights use several LEDs. If there is a LED which is not turned on, see your dealer for this service.

## Brakelight/Taillight/License Plate Light

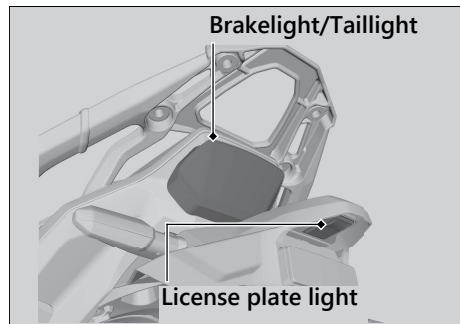

The brakelight, taillight and license plate light use several LEDs. If there is a LED which is not turned on, see your dealer for this service.

## Front/Rear Turn Signal

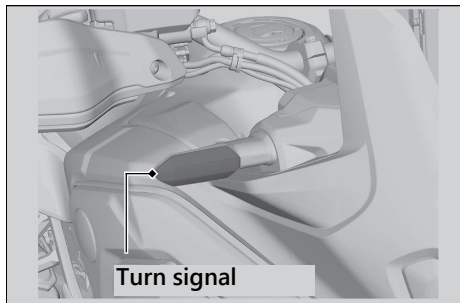

The front and rear turn signals use several LEDs.

If there is a LED which is not turned on, see your dealer for this service.

## Blown Fuse

Before handling fuses, see “Inspecting and Replacing Fuses.” ► P. 241

### ■ Fuse Box Fuses & ABS FSR Fuse

1. Remove the front seat. ► P. 253
2. Open the fuse box covers.
3. Pull the fuses out with the fuse puller provided on the underside of the rear seat (► P. 230) one by one check for a blown fuse. Always replace a blown fuse with a spare fuse of the same rating.
4. Close the fuse box covers.
5. Reinstall the front seat.

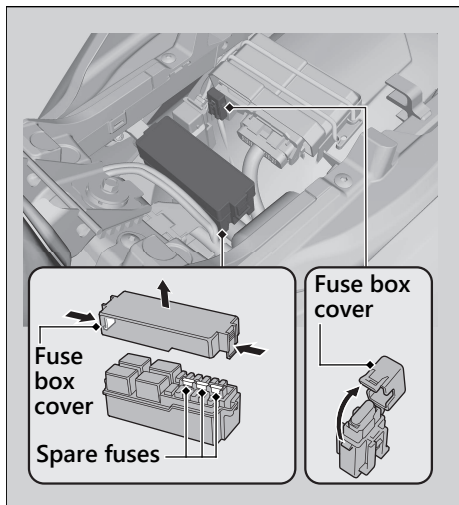

## Main Fuse & ABS Main Fuse

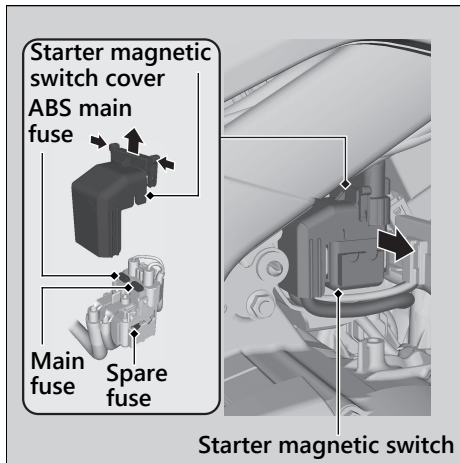

1. Remove the battery box cover. ► P. 251
2. Pull the starter magnetic switch out.
3. Remove the starter magnetic switch cover.
4. Pull the main fuse and ABS main fuse out with the fuse puller provided on the underside of the rear seat (► P. 230) one by one check for a blown fuse. Always replace a blown fuse with a spare fuse of the same rating.
  - Spare main fuse and spare ABS main fuse are provided in the starter magnetic switch.
5. Reinstall parts in the reverse order of removal.

## FI Fuse & Main 2 Fuse

CRF1100A/A2/A4

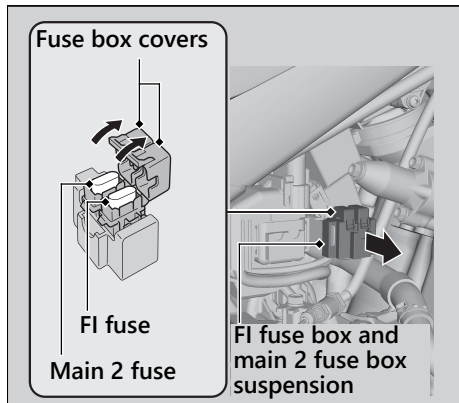

1. Remove the battery box cover. ► P. 251
2. Pull the FI fuse box and main 2 fuse box suspension out.
3. Open the fuse box cover.
4. Pull the FI fuse and main 2 fuse out with the fuse puller provided on the underside of the rear seat (► P. 230) and check for a blown fuse. Always replace a blown fuse with a spare fuse of the same rating.
  - Spare FI fuse is provided in the fuse box under the front seat.
  - Spare main 2 fuse is provided in the starter magnetic switch.
5. Reinstall parts in the reverse order of removal.

## FI Fuse & Main 2 Fuse & DCT Main Fuse

CRF1100D/D2/D4

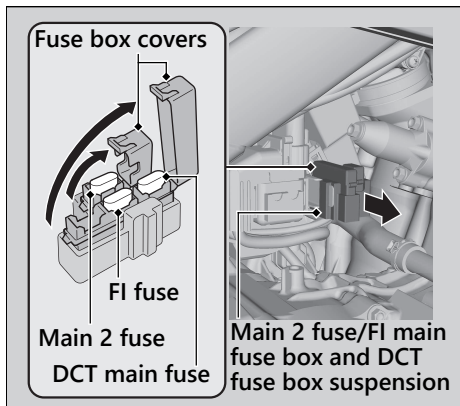

1. Remove the battery box cover. ► P. 251
2. Pull the main 2 fuse/FI main fuse box and DCT fuse box suspension out.
3. Open the fuse box covers.
4. Pull the FI fuse, main 2 fuse and DCT main fuse out with the fuse puller provided on the underside of the rear seat (► P. 230) one by one check for a blown fuse. Always replace a blown fuse with a spare fuse of the same rating.
  - Spare FI fuse is provided in the fuse box under the front seat.
  - Spare main 2 fuse and spare DCT main fuse are provided in the starter magnetic switch.
5. Reinstall parts in the reverse order of removal.

### NOTICE

If a fuse fails repeatedly, you likely have an electrical problem. Have your vehicle inspected by your dealer.



# Information

Keys.....	P. 340
Instruments, Controls, & Other Features...	P. 341
Caring for Your Vehicle.....	P. 345
Storing Your Vehicle.....	P. 349
Transporting Your Vehicle .....	P. 350
You & the Environment .....	P. 351
Serial Numbers .....	P. 352
Fuels Containing Alcohol .....	P. 353
Catalytic Converter .....	P. 354

## Service Diagnostic Recorders

This vehicle is equipped with service-related devices that record information about powertrain performance. The data can be used to verify emissions law requirements and/or help technicians diagnose and solve service problems. It may also be combined with data from other sources for research purposes, but it remains confidential. Some diagnostic and maintenance information is uploaded to Honda upon vehicle start up.

## Keys

### Ignition Key

This vehicle has two ignition keys and a key tag with a key number and a bar code.

The ignition key contains a special coded chip that is recognized by the immobilizer system (HISS) in order to start the engine. Handle the key carefully to prevent damaging the HISS components.

- Do not bend keys or subject them to undue stress.
- Avoid prolonged exposure to sunlight or high temperatures.
- Do not grind, drill or in any way alter their shape.
- Do not expose to strong magnetic objects.

If you lose all ignition keys and the key tag, the PGM-FI unit/ignition control module must be replaced by your dealer. To avoid this, keep a duplicate key.

If you lose a key, make another duplicate key immediately.

To make a duplicate key and register it with your HISS system, take the spare key, the key tag, and the vehicle to your dealer.

- ▶ Store the key tag in a safe location.

A metal key holder may cause damage to the area surrounding the ignition switch.

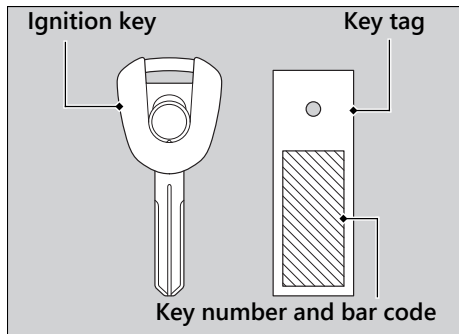

## Instruments, Controls, & Other Features

### Ignition Switch

Leaving the ignition switch in the **I** (On) position with the engine stopped will drain the battery. Do not turn the key while riding.

### Engine Stop Switch

Do not use the engine stop switch except in an emergency. Doing so when riding will cause the engine to suddenly turn off, making riding unsafe.

If you stop the engine using the engine stop switch, turn the ignition switch to the **O** (Off) position. Failing to do so will drain the battery.

### Odometer



The display locks at 999,999 when the read-out exceeds 999,999.

### Tripmeter

The tripmeters return to 0.0 when each read-out exceeds 9,999.9.

### HISS

The Honda Ignition Security System (HISS) immobilizes the engine's ignition system if an improperly-coded key is used to try and start the engine. When the ignition switch is turned to the  (Off) position, the HISS immobilizer system is always alert, even if the HISS indicator is not flashing.

If the ignition switch is turned to the  (On) position with the engine stop switch in the  (Run) position, the HISS indicator turns on and goes off after a few seconds to indicate it is OK to start the engine. **HISS Indicator Does Not Turn off**  P. 299

The HISS indicator starts flashing every 2 seconds for 24 hours after the ignition switch is turned to the  (Off) position. You can turn this feature on or off.  P. 80

### EU Directive

This immobilizer system complies with the RE (Radio Equipment) Directive (2014/53/EU).



The declaration of conformity to RE Directive is provided to the owner at the time of purchase. The declaration of conformity should be kept at a safe place. When the declaration of conformity is lost or is not provided, contact your dealer.

#### South Africa only



#### Morocco only



## Audio system

### EU Directive

This audio system complies with the RE (Radio Equipment) Directive (2014/53/EU).



The declaration of conformity to RE Directive is provided to the owner at the time of purchase. The declaration of conformity should be kept at a safe place. When the declaration of conformity is lost or is not provided, contact your dealer.

#### South Africa only



### Document Bag

The owner's manual, registration, and insurance information can be stored in the plastic document bag located on the underside of the front seat. 📄 P. 229

### Ignition Cut-off System

IMU (Inertia Measurement Unit) sensor automatically stops the engine and fuel pump if the vehicle falls over. To reset the IMU, you must turn the ignition switch to the **○** (Off) position and back to the **I** (On) position before the engine can be restarted.

If a failure of the IMU is detected, the engine and fuel pump will not stop automatically when the vehicle falls over.

### Assist-slipper Clutch System

#### CRF1100A/A2/A4

The assist-slipper clutch system helps to prevent the rear tyre from locking up when the deceleration of your vehicle produces a strong engine braking effect. It also makes the clutch lever operation feel lighter.

Use only MA classification engine oil for your vehicle. Using engine oil other than MA classification oil could result in damage to the assist-slipper clutch system.

### Throttle by Wire System

This model is equipped with a Throttle by Wire System.

Do not put magnetized items or items susceptible to magnetic interference near the right handlebar switches.

## DRL, Automatic Brightness Control and Background Control

Ambient brightness is detected by the photosensor.

Do not damage or cover the photosensor.

Otherwise, the DRL, automatic brightness control and background control may not work properly.

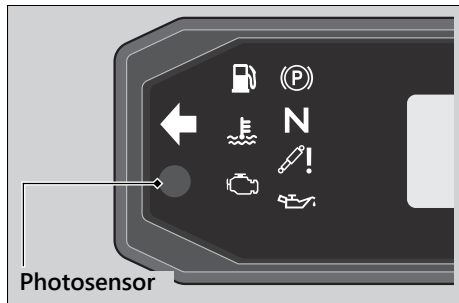

## Caring for Your Vehicle

Frequent cleaning and polishing is important to ensure the life of your Honda. A clean vehicle makes it easier to spot potential problems. In particular, seawater and salts used to prevent ice on roads promote the formation of corrosion. Always wash your vehicle thoroughly after riding on coastal or treated roads.

### Washing

Allow the engine, muffler, brakes, and other high-temperature parts to cool before washing.

1. Rinse your vehicle thoroughly using a low pressure garden hose to remove loose dirt.
2. If necessary, use a sponge or a soft towel with mild cleaner to remove road grime.
  - ▶ Clean the windscreen, headlight lens, panels, and other plastic components with extra care to avoid scratching them. Avoid directing water into the air cleaner, muffler, and electrical parts.
3. Thoroughly rinse your vehicle with plenty of clean water and dry with a soft, clean cloth.
4. After the vehicle dries, lubricate any moving parts.
  - ▶ Make sure that no lubricant spills onto the brakes or tyres. Brake discs, pads, drum or shoes contaminated with oil will suffer greatly reduced braking effectiveness and can lead to a crash.
5. Lubricate the drive chain immediately after washing and drying the vehicle.
6. Apply a coat of wax to prevent corrosion.
  - ▶ Avoid products that contain harsh detergents or chemical solvents. These can damage the metal, paint, and plastic on your vehicle.  
Keep the wax clear of the tyres and brakes.
  - ▶ If your vehicle has any mat painted parts, do not apply a coat of wax to the mat painted surface.



## Washing Precautions

Follow these guidelines when washing:

- Do not use high-pressure washers:
    - ▶ High-pressure water cleaners can damage moving parts and electrical parts, rendering them inoperable.
    - ▶ Water in the air intake can be drawn into the throttle body and/or enter the air cleaner.
  - Do not direct water at the muffler:
    - ▶ Water in the muffler can prevent starting and causes rust in the muffler.
  - Dry the brakes:
    - ▶ Water adversely affects braking effectiveness. After washing, apply the brakes intermittently at low speed to help dry them.
  - Do not direct water under the seat:
    - ▶ Water in the under seat compartment can damage your documents and other belongings.
- 
- Do not direct water at the air cleaner:
    - ▶ Water in the air cleaner can prevent the engine from starting.
  - Do not direct water near the headlight:
    - ▶ The headlight's inside lens may fog temporarily after washing or while riding in the rain. This does not impact the headlight function.  
However, if you see a large amount of water or ice accumulated inside the lens(es), have your vehicle inspected by your dealer.
  - Do not use wax or polishing compounds on mat painted surface:
    - ▶ Use a soft cloth or sponge, plenty of water, and a mild detergent to clean mat painted surfaces. Dry with a soft clean cloth.

### Aluminium Components

Aluminium will corrode from contact with dirt, mud, or road salt. Clean aluminium parts regularly and follow these guidelines to avoid scratches:

- Do not use stiff brushes, steel wool, or cleaners containing abrasives.
- Avoid riding over or scraping against curbs.

### Panels

Follow these guidelines to prevent scratches and blemishes:

- Wash gently using a soft sponge and plenty of water.
- To remove stubborn stains, use diluted detergent and rinse thoroughly with plenty of water.
- Avoid getting petrol, brake fluid, or detergents on the instruments, panels, or headlight.

### Windscreen

Using plenty of water, clean the windscreen with a soft cloth or sponge. (Avoid using detergents or any kind of chemical cleaner on the windscreen.) Dry with a soft, clean cloth.

#### NOTICE

To avoid possible scratching or other damage, use only water and a soft cloth or sponge to clean the windscreen.

For a dirtier windscreen, use a diluted neutral detergent with a sponge and plenty of water. Make sure to wash off all the detergent. (Detergent residue may cause windscreen cracks.)

Replace the windscreen if scratches cannot be removed and they obstruct clear vision.

Take care to keep battery electrolyte, brake fluid, or other chemical solvents off the windscreen and screen garnish. They will damage the plastic.

## Exhaust Pipe and Muffler

The exhaust pipe and muffler are stainless steel but may become stained by mud or dust.

To remove mud or dust, use a wet sponge and a liquid kitchen abrasive, then rinse well with clean water. Dry with chamois or a soft towel.

If necessary, remove heat stains by using a commercially available fine texture compound. Then rinse by the same manner as removing mud or dust.

When the exhaust pipe and muffler are painted, do not use a commercially available abrasive kitchen cleaning compound. Use a neutral detergent to clean the painted surface on the exhaust pipe and muffler. If you are not sure if your exhaust pipe and muffler are painted, contact your dealer.

### NOTICE

Even though the exhaust is made of stainless steel, it can become stained. Remove all marks and blemishes as soon as they are noticed.

## Storing Your Vehicle

If you store your vehicle outdoors, you should consider using a full-body cover.

If you won't be riding for an extended period, follow these guidelines:

- Wash your vehicle and wax all painted surfaces (except mat painted surfaces). Coat chrome pieces with rust-inhibiting oil.
- Lubricate the drive chain. ➤ P. 243
- Place your vehicle on a maintenance stand and position a block so that both tyres are off the ground.
- After rain, remove the body cover and allow the vehicle to dry.

## Transporting Your Vehicle

- Remove the battery (➤ P. 250) to prevent discharge. Fully charge the battery and then place it in a shaded, well-ventilated area.
  - ▶ If you leave the battery in place, disconnect the negative ⊖ terminal to prevent discharge.

After removing your vehicle from storage, inspect all maintenance items required by the Maintenance Schedule.

## Transporting Your Vehicle

If your vehicle needs to be transported, it should be carried on a motorcycle trailer or a flatbed truck or trailer that has a loading ramp or lifting platform, and motorcycle tie-down straps. Never try to tow your vehicle with a wheel or wheels on the ground.

### NOTICE

Towing your vehicle can cause serious damage to the transmission.

## You & the Environment

Owning and riding a vehicle can be enjoyable, but you must do your part to protect the environment.

### Choose Sensible Cleaners

Use a biodegradable detergent when you wash your vehicle. Avoid aerosol spray cleaners that contain chlorofluorocarbons (CFCs) which damage the atmosphere's protective ozone layer.

### Recycle Wastes

Put oil and other toxic wastes in approved containers and take them to a recycling centre. Call your local or state office of public works or environmental services to find a recycling centre in your area, and to get instructions on how to dispose of non-recyclable wastes. Do not place used engine oil in the trash, or pour it down a drain or on the ground. Used oil, petrol, coolant, and cleaning solvents contain poisons that can hurt refuse workers and contaminate drinking water, lakes, rivers, and oceans.

## Serial Numbers

The frame and engine serial numbers uniquely identify your vehicle and are required in order to register your vehicle. They may also be required when ordering replacement parts. You should record these numbers and keep them in a safe place.

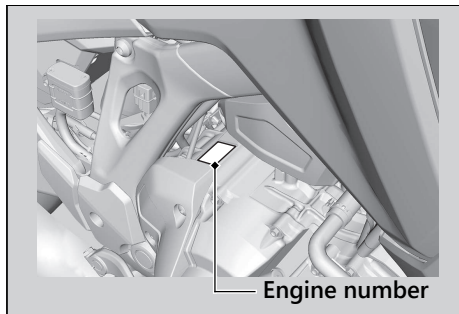
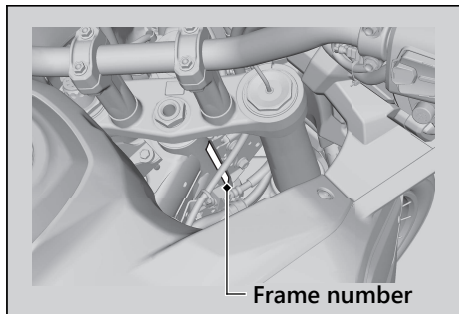

## Fuels Containing Alcohol

Some conventional fuels blended with alcohol are available in some locales to help reduce emissions to meet clean air standards. If you plan to use blended fuel, check that it is unleaded and meets the minimum octane rating requirement.

The following fuel blends can be used in your vehicle:

- Ethanol (ethyl alcohol) up to 10% by volume.
  - ▶ Petrol containing ethanol may be marketed under the name Gasohol.

The use of petrol containing more than 10% ethanol may:

- Damage the painting of the fuel tank.
- Damage the rubber tubes of the fuel line.
- Cause corrosion of the fuel tank.
- Cause poor drivability.

### NOTICE

Use of blended fuels containing higher than approved percentages can damage metal, rubber, plastic parts of your fuel system.

If you notice any undesirable operating symptoms or performance problems, try a different brand of petrol.

## Catalytic Converter

This vehicle is equipped with two three-way catalytic converters. Each catalytic converter contains precious metals that serve as catalysts in high temperature chemical reactions that convert hydrocarbons (HC), carbon monoxide (CO), and oxides of nitrogen (NOx) in the exhaust gasses into safe compounds.

A defective catalytic converter contributes to air pollution and can impair your engine's performance. A replacement unit must be an original Honda part or equivalent.

Follow these guidelines to protect your vehicle's catalytic converters.

- Always use unleaded petrol. Leaded petrol will damage the catalytic converters.
- Keep the engine in good running condition.
- Have your vehicle serviced if your engine is misfiring, backfiring, stalling, or otherwise not running properly, stop riding and turn off the engine.



## Legal Information on Apple CarPlay

### OWNER'S MANUAL LICENSE/LIABILITY STATEMENTS

USE OF APPLE CARPLAY IS SUBJECT TO YOUR AGREEMENT TO THE CARPLAY TERMS OF USE, WHICH ARE INCLUDED AS PART OF THE APPLE iOS TERMS OF USE. IN SUMMARY, THE CARPLAY TERMS OF USE DISCLAIM APPLE AND ITS SERVICE PROVIDERS' LIABILITY IF THE SERVICES FAIL TO PERFORM CORRECTLY OR ARE DISCONTINUED, STRICTLY LIMIT APPLE AND ITS SERVICE PROVIDERS' OTHER LIABILITIES, DESCRIBE THE KINDS OF USER INFORMATION (INCLUDING, FOR EXAMPLE, VEHICLE LOCATION, VEHICLE SPEED, AND VEHICLE STATUS) BEING GATHERED AND STORED BY APPLE AND ITS SERVICE PROVIDERS, AND DISCLOSE CERTAIN POSSIBLE RISKS ASSOCIATED WITH THE USE

OF CARPLAY, INCLUDING THE POTENTIAL FOR DRIVER DISTRACTION.

SEE APPLE'S PRIVACY POLICY FOR DETAILS REGARDING APPLE'S USE AND HANDLING OF DATA UPLOADED BY CARPLAY.

**DISCLAIMER OF WARRANTIES;  
LIMITATION ON LIABILITY**

YOU EXPRESSLY ACKNOWLEDGE AND AGREE THAT USE OF APPLE CARPLAY (“THE APPLICATIONS”) IS AT YOUR SOLE RISK AND THAT THE ENTIRE RISK AS TO SATISFACTORY QUALITY, PERFORMANCE, ACCURACY AND EFFORT IS WITH YOU TO THE MAXIMUM EXTENT PERMITTED BY APPLICABLE LAW, AND THAT THE APPLICATIONS AND INFORMATION ON THE APPLICATIONS IS PROVIDED “AS IS” AND “AS AVAILABLE,” WITH ALL FAULTS AND WITHOUT WARRANTY OF ANY KIND, AND HONDA HEREBY DISCLAIMS ALL WARRANTIES AND CONDITIONS WITH RESPECT TO THE APPLICATIONS AND INFORMATION ON THE APPLICATIONS, EITHER EXPRESS, IMPLIED OR STATUTORY, INCLUDING, BUT NOT LIMITED TO, THE IMPLIED WARRANTIES AND/OR CONDITIONS OF MERCHANTABILITY, SATISFACTORY QUALITY, FITNESS FOR A PARTICULAR PURPOSE, ACCURACY, QUIET

ENJOYMENT, AND NONINFRINGEMENT OF THIRD PARTY RIGHTS. NO ORAL OR WRITTEN INFORMATION OR ADVICE GIVEN BY HONDA OR AN AUTHORIZED REPRESENTATIVE SHALL CREATE A WARRANTY. AS EXAMPLES, AND WITHOUT LIMITATION, HONDA DISCLAIMS ANY WARRANTY REGARDING THE ACCURACY OF DATA PROVIDED BY THE APPLICATIONS, SUCH AS THE ACCURACY OF DIRECTIONS, ESTIMATED TRAVEL TIME, SPEED LIMITS, ROAD CONDITIONS, NEWS, WEATHER, TRAFFIC, OR OTHER CONTENT PROVIDED BY APPLE, THEIR AFFILIATES, OR THIRD PARTY PROVIDERS; HONDA DOES NOT GUARANTEE AGAINST LOSS OF APPLICATION DATA, WHICH MAY BE LOST AT ANY TIME; HONDA DOES NOT GUARANTEE THAT THE APPLICATIONS OR ANY SERVICES PROVIDED THROUGH THEM WILL BE PROVIDED AT ALL TIMES OR THAT ANY OR ALL SERVICES WILL BE AVAILABLE AT ANY PARTICULAR TIME OR LOCATION.

FOR EXAMPLE, SERVICES MAY BE SUSPENDED OR INTERRUPTED WITHOUT NOTICE FOR REPAIR, MAINTENANCE, SECURITY FIXES, UPDATES, ETC., SERVICES MAY BE UNAVAILABLE IN YOUR AREA OR LOCATION, ETC. IN ADDITION, YOU UNDERSTAND THAT CHANGES IN THIRD PARTY TECHNOLOGY OR GOVERNMENT REGULATION MAY RENDER THE SERVICES AND/OR APPLICATIONS OBSOLETE AND/OR UNUSABLE.

TO THE EXTENT NOT PROHIBITED BY LAW, IN NO EVENT SHALL HONDA OR ITS AFFILIATES BE LIABLE FOR PERSONAL INJURY, OR ANY INCIDENTAL, SPECIAL, INDIRECT OR CONSEQUENTIAL DAMAGES WHATSOEVER, INCLUDING, WITHOUT LIMITATION, DAMAGES FOR LOSS OF PROFITS, CORRUPTION OR LOSS OF DATA, FAILURE TO TRANSMIT OR RECEIVE ANY DATA, BUSINESS INTERRUPTION OR ANY OTHER COMMERCIAL DAMAGES OR LOSSES, ARISING OUT OF OR RELATED TO THE APPLICATIONS OR YOUR USE OF OR INABILITY

TO USE THE APPLICATIONS OR INFORMATION ON THE APPLICATIONS, HOWEVER CAUSED, REGARDLESS OF THE THEORY OF LIABILITY (CONTRACT, TORT OR OTHERWISE) AND EVEN IF HONDA WERE ADVISED OF THE POSSIBILITY OF SUCH DAMAGES. SOME REGIONS AND JURISDICTIONS MAY DISALLOW THE EXCLUSION OR LIMITATION OF LIABILITY FOR DAMAGES, SO THESE LIMITATIONS AND EXCLUSIONS MAY NOT APPLY TO YOU. THE FOREGOING LIMITATIONS WILL APPLY EVEN IF THE ABOVE STATED REMEDY FAILS OF ITS ESSENTIAL PURPOSE.

## Software Upgrades

### Upgrades

Honda is continually expanding the scope of the system software. The softwares are updated to correspond with new version releases.

For the software updates, contact your dealer.

# Specifications

## ■ Main Components

Overall length	2,330 mm (91.7 in)
Overall width	960 mm (37.8 in)
Overall height	<b>CRF1100A/D</b> 1,395 mm (54.9 in)
	<b>CRF1100A2/A4/D2/D4</b> 1,560 mm (61.4 in)
Wheelbase	1,575 mm (62.0 in)
Minimum ground clearance	250 mm (9.8 in)
Caster angle	27° 30'
Trail	113 mm (4.4 in)
Curb weight	<b>CRF1100A</b> 226 kg (498 lb)
	<b>CRF1100D</b> 236 kg (520 lb)
	<b>CRF1100A2</b> 238 kg (525 lb)
	<b>CRF1100D2</b> 248 kg (547 lb)
	<b>CRF1100A4</b> 240 kg (529 lb)
<b>CRF1100D4</b> 250 kg (551 lb)	

Maximum weight capacity *1	<b>CRF1100A/D</b> 220 kg (485 lb)
	<b>CRF1100A2/A4/D2/D4</b> 218 kg (481 lb)
Maximum luggage weight *2	29 kg (64 lb)
	<b>CRF1100A2/A4/D2/D4</b> Rear carrier 10 kg (22 lb)
Passenger capacity	Rider and 1 passenger
Minimum turning radius	2.6 m (8.5 ft)
Displacement	1,084 cm <sup>3</sup> (66.1 cu-in)
Bore x stroke	92.0 x 81.5 mm (3.62 x 3.21 in)
Compression ratio	10.1:1
Fuel	Unleaded petrol
	Recommended: 91 RON or higher
Fuels containing alcohol	ETHANOL up to 10 % by volume
Tank capacity	<b>CRF1100A/D</b> 18.8 L (4.97 US gal, 4.14 Imp gal)
	<b>CRF1100A2/A4/D2/D4</b> 24.8 L (6.55 US gal, 5.46 Imp gal)

\*1 : Including rider, passenger, all luggage, and accessories

\*2 : Includes the weight of the luggage and added accessories

## Specifications

Battery	HY110	
	12 V-6 Ah (20 HR)	
	<b>CRF1100A/A2/A4</b>	
	1st	2.866
	2nd	1.888
	3rd	1.480
	4th	1.230
Gear ratios	5th	1.064
	6th	0.972
	<b>CRF1100D/D2/D4</b>	
	1st	2.562
	2nd	1.761
	3rd	1.375
	4th	1.133
	5th	0.972
	6th	0.882
	<b>CRF1100A/A2/A4</b>	
	1.717 / 2.625	
	<b>CRF1100D/D2/D4</b>	
	1.863 / 2.625	

## ■ Service Data

Tyre size	Front	<b>CRF1100A/D</b>
		90/90-21M/C 54H
		<b>M+S</b>
		90/90-21M/C 54S
		<b>CRF1100A2/A4/D2/D4</b>
	90/90-21M/C 54H	
	<b>M+S</b>	
	90/90-21M/C 54T	
	150/70R18M/C 70H	
	Rear	<b>M+S</b>
150/70B18M/C 70Q		

Tyre type	Front	<b>CRF1100A/D</b> Bias-ply, tube
		<b>M+S</b> Bias-ply, tube
		<b>CRF1100A2/A4/D2/D4</b> Bias-ply, tubeless
	Rear	<b>M+S</b> Bias-ply, tubeless
		<b>CRF1100A/D</b> Radial, tube
		<b>M+S</b> Bias-ply, tube
		<b>CRF1100A2/A4/D2/D4</b> Radial, tubeless
		<b>M+S</b> Bias-ply, tubeless

Recommended Tyres	Front	<b>CRF1100A/D</b> BRIDGESTONE BATTLAX ADVENTURECROSS TOURER AX41TF G
		METZELER KAROO STREET
		<b>M+S</b> Continental TKC80 Twinduro
		<b>CRF1100A2/A4/D2/D4</b> BRIDGESTONE BATTLAX ADVENTURECROSS TOURER AX41TF L
		METZELER KAROO STREET
		<b>M+S</b> Continental TKC80 Twinduro

## Specifications

Recommended Tyres	Rear	<b>CRF1100A/D</b> BRIDGESTONE BATTLEAX ADVENTURECROSS TOURER AX41TR G
		METZELER KAROO STREET <b>M+S</b> Continental TKC80 Twinduro
		<b>CRF1100A2/A4/D2/D4</b> BRIDGESTONE BATTLEAX ADVENTURECROSS TOURER AX41TR L
		METZELER KAROO STREET <b>M+S</b> Continental TKC80 Twinduro

Tyre category of use <sup>*1</sup>	Normal	Permitted
	Special	Not Permitted
	Snow <sup>*2</sup> (M+S on the tyre sidewall marking)	Permitted
	Moped	Not Permitted
Tyre air pressure (Driver only)	Front	225 kPa (2.25 kgf/cm <sup>2</sup> , 33 psi)
	Rear	250 kPa (2.50 kgf/cm <sup>2</sup> , 36 psi)
Tyre air pressure (Driver and passenger)	Front	225 kPa (2.25 kgf/cm <sup>2</sup> , 33 psi)
	Rear	280 kPa (2.80 kgf/cm <sup>2</sup> , 41 psi)
Minimum tread depth		1.5 mm (0.06 in)
	Front	<b>M+S</b> 3.0 mm (0.12 in)
		2.0 mm (0.08 in)
	Rear	<b>M+S</b> 3.0 mm (0.12 in)

\*1: Categorized by UNECE Regulation No. 75

\*2: Snow is not limited as snow, but includes DP (Dual Purpose), M+S, MS, M&S (mud and snow)



Spark plugs	(standard) SILMAR8A9S (NGK)	
Spark plug gap	(non-adjustable) 0.8 - 0.9 mm (0.03 - 0.04 in)	
Idle speed	1,250 ± 100 rpm	
Recommended engine oil	Honda 4-stroke motorcycle oil API Service Classification SG or higher, excluding oils marked as "Energy Conserving" or "Resource Conserving," SAE 10W-30, JASO T 903 standard MA	
Engine oil capacity	<b>CRF1100A/A2/A4</b>	
	After draining	3.9 L (4.1 US qt, 3.4 Imp qt)
	After draining & engine oil filter change	4.0 L (4.2 US qt, 3.5 Imp qt)
	After disassembly	4.8 L (5.1 US qt, 4.2 Imp qt)
	<b>CRF1100D/D2/D4</b>	
	After draining	4.0 L (4.2 US qt, 3.5 Imp qt)
	After draining & engine oil filter change	4.2 L (4.4 US qt, 3.7 Imp qt)
	After draining, engine & clutch oil filter change	4.2 L (4.4 US qt, 3.7 Imp qt)
	After disassembly	5.2 L (5.5 US qt, 4.6 Imp qt)

Recommended brake fluid	Honda DOT 4 Brake Fluid	
Cooling system capacity	1.81 L (1.91 US qt, 1.59 Imp qt)	
Recommended coolant	Pro Honda HP Coolant	
Recommended drive chain lubricant	Drive chain lubricant designed specifically for O-ring chains. If not available, use SAE 80 or 90 gear oil.	
Drive chain slack	35 - 45 mm (1.4 - 1.8 in)	
Standard drive chain	DID 525HV3	
	No. of links	124
Standard sprocket size	Drive sprocket	16T
	Driven sprocket	42T

## Specifications

### ■ Bulbs

Headlight	LED
DRL	LED
Cornering light	LED
Brakelight/Taillight	LED
Front turn signal	LED
Rear turn signal	LED
License plate light	LED

### ■ Fuses

Main fuse	30 A
Other fuses	30 A, 20 A, 15 A, 10 A

### ■ Torque Specifications

Skid plate bolt A	26 N-m (2.7 kgf-m, 19 lbf-ft)
Skid plate bolt B	12 N-m (1.2 kgf-m, 9 lbf-ft)
<b>CRF1100A2/A4/D2/D4</b>	
Oil filter	26 N-m (2.7 kgf-m, 19 lbf-ft)
Engine oil drain bolt	30 N-m (3.1 kgf-m, 22 lbf-ft)
Clutch oil filter cover bolt	12 N-m (1.2 kgf-m, 9 lbf-ft)
<b>CRF1100D/D2/D4</b>	
Rear wheel axle nut	100 N-m (10.2 kgf-m, 74 lbf-ft)
Drive chain adjusting lock nut	27 N-m (2.8 kgf-m, 20 lbf-ft)
Front wheel axle nut	65 N-m (6.6 kgf-m, 48 lbf-ft)
Front wheel axle pinch bolt	22 N-m (2.2 kgf-m, 16 lbf-ft)
Front wheel brake caliper mounting bolt	45 N-m (4.6 kgf-m, 33 lbf-ft)

- A**
- ABS (Anti-lock Brake System)..... 14
  - ABS (Anti-lock Brake System)
    - Indicator..... 113, 303
  - ABS Function on the Rear Wheel ..... 122
  - Accessories..... 17
  - Accessory Socket..... 225
  - Air Cleaner..... 248
  - Air Temperature Gauge..... 66
  - Apple CarPlay..... 192
  - AT indicator..... 24
  - AT MODE..... 24, 25, 31, 209, 211, 212, 213
  - Automatic Background Control ..... 345, 345
- B**
- Battery..... 250
  - Battery Box Cover..... 251
  - Bluetooth® Audio..... 158
  - Brake Lever..... 285
  - Brakelight Switch..... 271
  - Brakes
    - Fluid..... 242, 268, 360
    - Lever Adjustment..... 285
    - Pad Wear..... 269
  - Parking ..... 129
- Braking** ..... 13
- Bulb**
- Brakelight..... 333
  - Cornering Light..... 333
  - DRL..... 332
  - Front Turn Signal..... 334
  - Headlight..... 332
  - License Plate Light..... 333
  - Rear Turn Signal..... 334
  - Taillight..... 333
- C**
- Catalytic Converter..... 354
  - Clutch Oil Filter ..... 264
  - Colour Label..... 238
  - Coolant..... 266
  - Coolant Temperature Gauge ..... 29
  - Cornering Light..... 223
  - Crankcase Breather ..... 283
  - Crash ..... 5
  - Cruise Control..... 215
  - Cruise Control Main Indicator ..... 113
  - Cruise Control SET Indicator..... 113

- D**
- D Mode** ..... 209, 211, 212
  - Drive Chain** ..... 243, 273
  - Drive Chain Slider** ..... 276
  - DRL**..... 345
  - DRL (Daytime Running Light)**..... 222
  - DRL Indicator**..... 111
- E**
- Electrical Trouble** ..... 331
  - Emergency Stop Signal** ..... 220
  - Engine**
    - Number ..... 352
    - Oil ..... 241
    - Oil Filter ..... 262
    - Overheats ..... 300
    - Starting ..... 206
    - Stop Switch ..... 117, 206, 207, 341
    - Stopping ..... 341
    - Will Not Start ..... 299
  - Environment** ..... 351
  - Equipment**
    - Document Bag ..... 229
    - Fuse Puller ..... 230
    - Helmet Holder ..... 228
    - Helmet Set Wire ..... 229
    - Hex Wrench ..... 230
    - Rear Carrier ..... 231
    - Screwdriver handle ..... 230
    - Standard/Phillips screwdriver ..... 230
    - Tool Kit ..... 230
- F**
- Flooded Engine** ..... 206
  - Frame Number** ..... 352
  - Frame number** ..... 352
  - Front Suspension** ..... 286
  - Fuel**
    - Gauge ..... 29, 32, 37
    - Recommended ..... 224
    - Remaining ..... 29, 32, 37
    - Tank Capacity ..... 224
  - Fuels Containing Alcohol** ..... 353
  - Fuses** ..... 240, 335
- G**
- G Indicator** ..... 30
  - G Switch** ..... 126

Gasohol .....	353
Gear Position Indicator .....	25, 31

## **H**

Handle Grip Heater .....	130
Handsfree Calling .....	181
Headlight Aim .....	284
Helmet Holder.....	228
High Beam Indicator.....	111
High Coolant Temperature Indicator .....	110
HISS Indicator .....	114, 299
Horn Button .....	118

## **I**

### **Ignition Cut-off System**

IMU (Inertia Measurement Unit) .....	344
Side Stand .....	272
Ignition Key.....	340
Ignition Switch.....	116, 206, 207, 341
Image Labels .....	7
Indicators.....	110
Instruments .....	24
<b>Instruments, Controls, &amp; Other</b>	
Features .....	341

## **L**

Labels.....	7
Left Handrbar Switch.....	118
Legal Information on Apple CarPlay .....	355
Load Limits .....	19
Loading Guidelines.....	19
Low Oil Pressure Indicator .....	114, 301

## **M**

### **Maintenance**

Fundamentals .....	237
Importance .....	233
Safety .....	233
Schedule .....	234

<b>Maximum Weight Limit</b> .....	19
-----------------------------------	----

<b>Modifications</b> .....	17
----------------------------	----

<b>MT MODE</b> .....	25, 31, 209, 211, 212, 214
----------------------	----------------------------

<b>Multi-Information Display</b> .....	26
--	----

## **N**

<b>N-D Switch</b> .....	117
<b>Neutral Indicator</b> .....	112

**O**

Odometer .....	24, 342
Off-Road Safety .....	18
<b>Oil</b>	
Engine .....	241, 260
Overheating .....	300

**P**

Parking .....	15
Parking Brake .....	129
Parking Brake Indicator .....	112
Parking Brake Lever .....	129
Parts Location .....	20
Passing Light Control Switch .....	119
Petrol .....	224
<b>PGM-FI (Programmed Fuel Injection)</b>	
Malfunction Indicator Lamp (MIL) .....	110, 302
Protective Apparel .....	12

**R**

<b>Rear ABS (Anti-lock Brake System) OFF</b>	
Indicator .....	113
Rear Suspension .....	290

**Recommended**

Coolant .....	244
Engine Oil .....	241, 260
Fuel .....	224
Oil .....	241

<b>Refuelling</b> .....	224
-------------------------	-----

**Removal**

Battery .....	250
Battery Box Cover .....	251
Clip .....	252
Front Seat .....	253
Rear Seat .....	255
Skid Plate .....	257
Tool Box .....	259

<b>Riding Mode</b> .....	142, 144
--------------------------	----------

<b>Riding Precautions</b> .....	13
---------------------------------	----

<b>Right Handrbar Switch</b> .....	117
------------------------------------	-----

**S**

<b>S Indicator</b> .....	25
--------------------------	----

<b>S Mode</b> .....	25, 31, 209, 211, 212, 213
---------------------	----------------------------

<b>Safety Guidelines</b> .....	3
--------------------------------	---

<b>Safety Precautions</b> .....	12
---------------------------------	----

<b>Serial Numbers</b> .....	352
-----------------------------	-----

Service Diagnostic Recorders .....	340
Shifting Gears .....	208
Side Stand .....	272
Side Stand Ignition Cut-off System .....	272
Side Stand Indicator.....	66
Software Upgrades .....	358
Specifications.....	359
Speedometer.....	24, 28, 33
Start Button.....	117, 206, 207
Starting the Engine .....	206
Steering Lock.....	121
Stopping Engine .....	341
<b>Storage</b>	
Equipment.....	228
Fuse Puller .....	230
Helmet Holder.....	228
Helmet Set Wire.....	229
Hex Wrench .....	230
Owner's Manual.....	229
Rear Carrier .....	231
Screwdriver handle.....	230
Standard/Phillips screwdriver .....	230
Tool Kit .....	230
Storing Your Vehicle.....	349

<b>Suspension Indicator .....</b>	<b>114</b>
<b>Switch</b>	
AT/MT Switch .....	117
Back Switch.....	120
Cruise Control Main Switch.....	117
ENT Switch .....	120
Favourite Switch.....	118
Function Lever .....	119
Function Switch .....	117
Goes Back Switch.....	120
Hazard Switch.....	118
Headlight Dimmer Switch.....	119
Page Switch.....	119
Sel Down Switch.....	120
Sel Left/Right Switch .....	120
Sel Up Switch .....	120
Shift Down Switch (-) .....	118
Shift Up Switch (+).....	119
Skip Switch.....	120
Turn Signal Switch .....	118
Voice Control Switch.....	119
<b>Switches .....</b>	<b>116</b>

<b>T</b>	
Tachometer .....	29, 33, 37
Throttle .....	282
Torque Control .....	16, 133
Torque Control Indicator .....	111, 304
Torque Control OFF Indicator .....	111
Transporting Your Vehicle.....	350
Tripmeter.....	342
Troubleshooting .....	298
Turn Signal Indicators.....	110, 111
<b>Tyres</b>	
Air Pressure .....	245
Puncture.....	308
Replacing.....	245, 308
<b>U</b>	
USB Socket.....	226
<b>W</b>	
Washing Your Vehicle .....	346
Weight Limit.....	19, 359
Wheelie Control.....	138
<b>Wheels</b>	
Front Removal .....	310
Rear Removal.....	314
Rims & Spokes.....	277



**HONDA**

The Power of Dreams

32MKS600  
00X32-MKS-6000

英 Y 4000.2019.07.L  
PRINTED IN JAPAN

