







As you read this manual, you will find Information that is preceded by a symbol **NOTICE**. This information is intended to help you avoid damage to your vehicle, other property, or the environment.

Symbols   or   on labels attached to your vehicle are to remind you to read this owner's manual for proper and safe operation of your vehicle.

 or  is colour-coded to indicate “danger” (red), “warning” (orange), or “caution” (amber).

 **Safety Labels** P. 99

A Few Words About Safety

Your safety, and the safety of others, is very important. And operating this vehicle safely is an important responsibility.

To help you make informed decisions about safety, we have provided operating procedures and other information on labels and in this manual. This information alerts you to potential hazards that could hurt you or others.

Of course, it is not practical or possible to warn you about all the hazards associated with operating or maintaining your vehicle. You must use your own good judgement.

You will find this important safety information in a variety of forms, including:

- **Safety Labels** - on the vehicle.
- **Safety Messages** - preceded by a safety alert symbol  and one of three signal words: **DANGER**, **WARNING**, or **CAUTION**. These signal words mean:

 **DANGER**

You WILL be KILLED or SERIOUSLY HURT if you don't follow instructions.

 **WARNING**

You CAN be KILLED or SERIOUSLY HURT if you don't follow instructions.

 **WARNING**

You CAN be KILLED or SERIOUSLY HURT if you don't follow instructions.

 **CAUTION**

You CAN be HURT if you don't follow instructions.

- **Safety Headings** - such as Important Safety Precautions.
- **Safety Section** - such as Safe Driving.
- **Instructions** - how to use this vehicle correctly and safely.

This entire book is filled with important safety information - please read it carefully.

Event Data Recorders

Your vehicle is equipped with several devices commonly referred to as Event Data Recorders. They record various types of real time vehicle data such as SRS airbag deployment and SRS system components failure.

This data belongs to the vehicle owner and may not be accessed by anyone else except as legally required or with the permission of the vehicle owner.

However this data may be accessed by Honda, its authorised dealers and authorised repairers, employees, representatives and contractors only for the purpose of the technical diagnosis, research and development of the vehicle.

Service Diagnostic Recorders

Your vehicle is equipped with service-related devices that record information about powertrain performance and driving conditions. The data can be used to help technicians diagnose, repair and maintain the vehicle. This data may not be accessed by anyone else except as legally required or with the permission of the vehicle owner.

However this data may be accessed by Honda, its authorised dealers and authorised repairers, employees, representatives and contractors only for the purpose of the technical diagnosis, research and development of the vehicle.

Vehicle Data Recordings

This vehicle records the following information as data when the Collision Mitigation Braking System (CMBS) is operated.

- Images of objects in front of the vehicle when the CMBS is activated
- Operational status of each function of the CMBS
- Accelerator / brake pedal operation
- Vehicle speed
- Information such as distance and relative speed of the target identified by the CMBS activated

Honda may obtain and use the recorded data for the purpose of technical diagnosis and research and development of Honda vehicles.

The CMBS does not record images or audio inside the vehicle. Special tools are required to review or remove data (including images) recorded by CMBS.

The CMBS image recording function can be turned off so that no images are recorded when CMBS is activated.

Disclosure of data

Honda will not disclose or provide the acquired data to third parties with data recorded by CMBS except in the following cases:

- When the owner of the vehicle consents
- When required by law, court order, or similar legally enforceable request
- When the data has been processed to de-identify/anonymise the vehicles/users, such as when aggregate data is provided to research institutions

Owner's Manual Application Terms and Conditions*

General

This application allows your Display Audio to automatically search for owner's manual updates that are specific to your vehicle and Display Audio every time the power mode of the vehicle is set to ON. This application periodically transmits a limited amount of vehicle and device information to our servers: Vehicle Identification Number (VIN), Display Audio hardware serial number, preferred language, Internet Protocol (IP) address, transaction log (alerts for or views of updates, update downloads and installation, usage of the owner's manual application), etc. When the application finds an update from the server, it prompts you to download and install.

When your Display Audio searches our servers for updates, we will automatically provide you with the opportunity to update the owner's manual. We will also maintain a log of the updates that are installed on our servers.

Your Personal Data

Should the aforementioned information transmitted to Honda constitute personal information in your region, please note that this information will be treated in strict accordance with the rules and regulations outlined in this notice as well as applicable data protection law.

The terms of our privacy policy are incorporated into these terms by reference and your use of system updates will be subject to the privacy policy. Our privacy policy sets out information about how we and any named third parties will process any personal data we collect from you or that you provide to us, via the utility. (See the Honda website (<https://www.privacynotice.honda.eu>) for further details.)

Honda collects, uses, and stores your personal data for the reasons set out below:

Where necessary for Honda's legitimate interests, as listed below, and where our interests are not overridden by your data protection rights.

- to deliver owner's manual updates to you;
- to allow us to improve and optimize the owner's manual application and services;
- to respond to user questions and complaints; and for internal record keeping.

Protecting our legitimate business interests and legal rights. This includes, but is not limited to, use in connection with compliance, regulatory, auditing, legal claims (including disclosure of such information in connection with legal process or litigation) and other ethics and compliance reporting requirements

Honda will also convert personal data into anonymous data and use it (normally on an aggregated statistical basis) for uses such as market research and analysis, to improve the owner's manual, to analyze trends, and to assess the success of software update releases. Aggregated personal information does not personally identify you or any other user of the owner's manual.

Honda may share this data with Honda's world wide support organization or affiliated Honda companies or other third parties engaged by Honda for the purposes of rendering support services in connection with system support.

* Not available on all models

System Updates Terms and Conditions

General

Your vehicle has an application that allows your Display Audio to automatically search for Honda software updates that are specific to your Display Audio and its connected devices (initially every one (1) week via Wi-Fi or every four (4) weeks via Telematics Control Unit (TCU)*, queries may occur more or less frequently due to internet outages, retries, direct user action, WAP push from the server or a change in query policy on the Honda servers). This application periodically transmits to our servers a limited amount of vehicle and device information (Vehicle Identification Number (VIN), the Model Type (MT) Identification Number, Hardware and Software Part Number, Serial Number, Software Version, preferred language, Internet Protocol (IP) address, Transaction Log (alert or update viewing, update download and installation, software status), etc.). When the application finds an update from the server, the application initially asks permission to download and install the update. You may elect to automatically download and install these updates in your settings, or, you may elect to manually update the system.

When your Display Audio searches our servers for updates or alerts, we will automatically provide you with the opportunity to update your devices or transmit the update or alert directly to your Display Audio. We will also maintain a log of the updates or alerts that are installed on our servers.

Your Personal Data

Should the aforementioned information transmitted to Honda constitute personal information in your region, please note that this information will be treated in strict accordance with the rules and regulations outlined in this notice as well as applicable data protection law.

* Not available on all models

The terms of our privacy policy are incorporated into these terms by reference and your use of system updates will be subject to the privacy policy. Our privacy policy sets out information about how we and any named third parties will process any personal data we collect from you or that you provide to us, via the application. See the Honda website for further details.

Honda collects, uses and stores your personal data for the reasons set out below:

Where necessary for Honda's legitimate interests, as listed below, and where our interests are not overridden by your data protection rights.

- to deliver the system updates and related services to you;
- to allow us to improve and optimize the system updates products and services;
- to respond to user questions and complaints; and for internal record keeping.

Protecting our legitimate business interests and legal rights includes, but is not limited to, use in connection with compliance, regulatory, auditing, legal claims (including disclosure of such information in connection with legal process or litigation) and other ethics and compliance reporting requirements.

Honda will also convert personal data into anonymous data and use it (normally on an aggregated statistical basis) for uses such as market research and analysis, to improve the system updates, to analyze trends, and to assess the success of software update releases. Aggregated personal information does not personally identify you or any other user of the system updates.

Honda may share this data with Honda's worldwide support organization or affiliated Honda companies or other third parties engaged by Honda for the purposes of rendering support services in connection with system support.

This owner's manual should be considered a permanent part of the vehicle and should remain with the vehicle when it is sold.

This owner's manual covers all models of your vehicle. You may find descriptions of equipment and features that are not on your particular model.

Images throughout this owner's manual represent features and equipment that are available on some, but not all, models. Your particular model may not have some of these features.

The information and specifications included in this publication were in effect at the time of approval for printing. Honda Motor Co., Ltd. reserves the right, however, to discontinue or change specifications or design at any time without notice and without incurring any obligation.

Although this manual is applicable to both right-hand and left-hand drive models, the illustrations contained in this manual mainly refer to the left-hand drive models.

➤ Safe Driving P. 39

For Safe Driving P. 40 Seat Belts P. 45 Airbags P. 58

➤ Instrument Panel P. 101

Indicators P. 102 Gauges and Driver Information Interface P. 132

➤ Controls P. 149

Clock P. 150 Locking and Unlocking the Doors P. 151
Operating the Switches Around the Steering Wheel P. 180
Interior Convenience Items P. 219

➤ Features P. 245

Audio System P. 246 Display Audio P. 248
Emergency Call (eCall) P. 344 Refuel Recommend P. 349

➤ Driving P. 351

Before Driving P. 352 Towing a Trailer P. 356
Parking Your Vehicle P. 481 Multi-View Rear Camera P. 493

➤ Maintenance P. 499

Before Performing Maintenance P. 500 Service Reminder System* P. 504
Checking and Maintaining Wiper Blades P. 536
Climate Control System Maintenance P. 554 Cleaning P. 558

➤ Handling the Unexpected P. 567

Tools P. 568 If a Tyre Goes Flat P. 569
If the 12-Volt Battery Is Dead P. 587 Shift Lever Does Not Move P. 590
Emergency Towing P. 606 If You Cannot Open the Tailgate P. 607

➤ Information P. 609

Specifications P. 610 Identification Numbers P. 612

Contents

Child Safety P. 73

Exhaust Gas Hazard P. 98

Safety Labels P. 99

Tailgate P. 163

Security System P. 174

Windows P. 177

Mirrors P. 203

Seats P. 207

Climate Control System P. 236

Audio Error Messages P. 337

General Information on the Audio System P. 338

Off-road Guidelines P. 357

When Driving P. 359

Honda Sensing P. 402

Braking P. 471

Refueling P. 495

Fuel Economy and CO₂ Emissions P. 498

Maintenance Schedule* P. 509

Maintenance Under the Bonnet P. 517

Replacing Light Bulbs P. 530

Checking and Maintaining Tyres P. 541

12-Volt Battery P. 546

Remote Transmitter Care P. 552

Accessories and Modifications P. 564

Handling of the Jack P. 582

Power System Won't Start P. 583

Overheating P. 591

Indicator, Coming On/Blinking P. 593

Fuses P. 600

Devices that Emit Radio Waves* P. 613

Declaration of conformity Content Outline* P. 655

Quick Reference Guide P. 6

Safe Driving P. 39

Instrument Panel P. 101

Controls P. 149

Features P. 245

Driving P. 351

Maintenance P. 499

Handling the Unexpected P. 567

Information P. 609

Index P. 656

Visual Index

Left-hand Drive Type

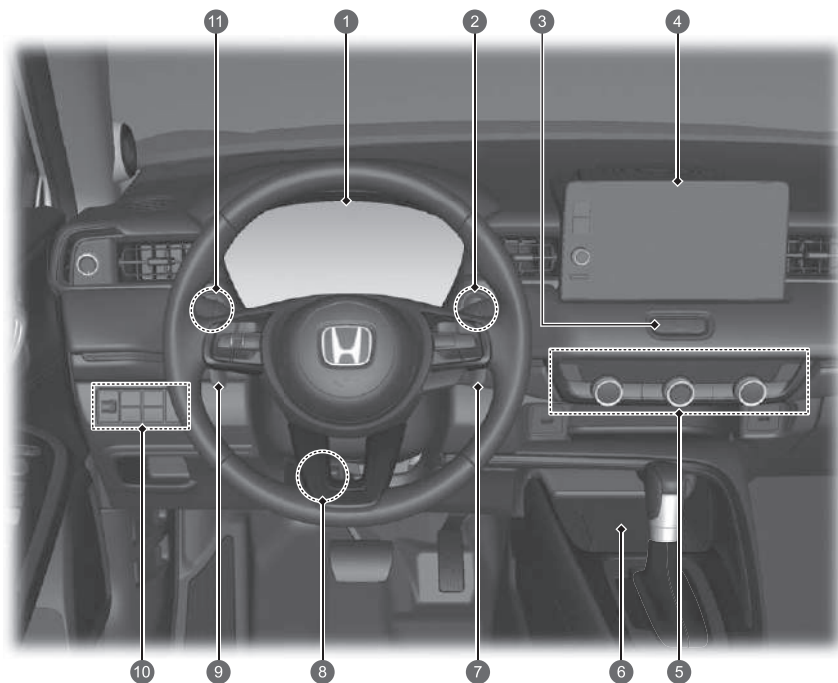

- 1 **System Indicators** ➔ P.102
Gauges ➔ P.132
Driver Information Interface ➔ P.135
- 2 **POWER Button** ➔ P.180
- 3 **Hazard Warning Button**
- 4 **Audio System** ➔ P.246
Navigation System
➔ See the Navigation System Manual
- 5 **Climate Control System** ➔ P.236
Rear Demister ➔ P.199
Heated Door Mirror Button ➔ P.199
Seat Heater Buttons ➔ P.235
- 6 **Wireless Charger*** ➔ P.231
- 7 **Deceleration Paddle Selector (+)** ➔ P.367
- 8 **Steering Wheel Adjustments** ➔ P.202
- 9 **Deceleration Paddle Selector (-)** ➔ P.367
- 10 **(Vehicle Stability Assist (VSA) System OFF) Button** ➔ P.390
Safety Support Switch ➔ P.397, 409, 456
Parking Sensor System Button ➔ P.484
Headlight Adjuster* ➔ P.192
Power Tailgate Button* ➔ P.169
Heated Windscreen Button* ➔ P.200
- 11 **Brightness Control** ➔ P.201

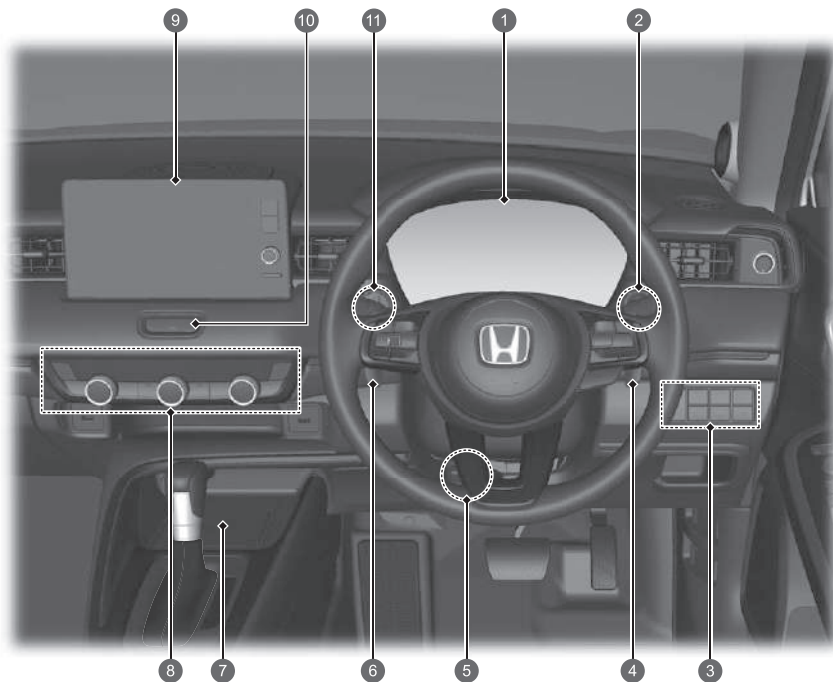

Right-hand Drive Type

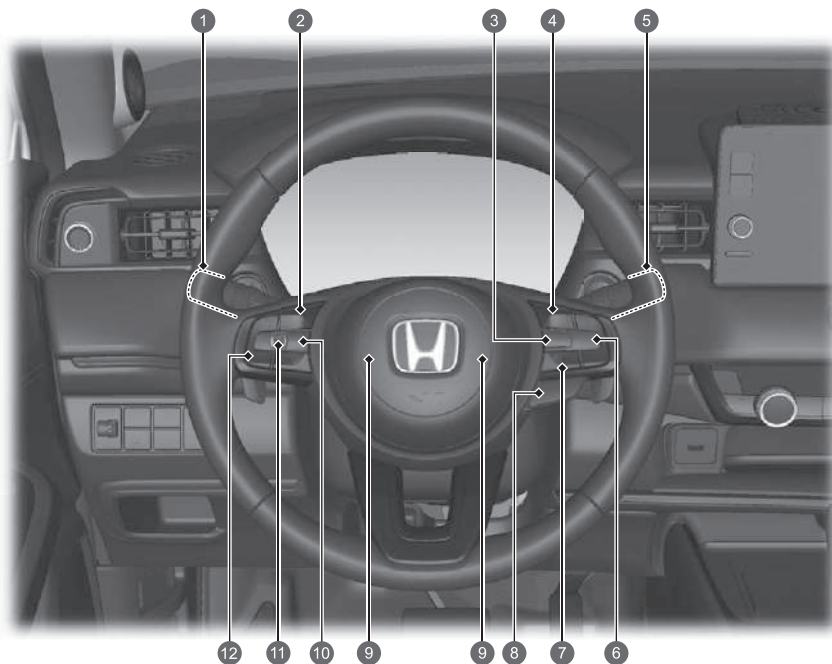

- 1 System Indicators ➔ P.102
Gauges ➔ P.132
Driver Information Interface ➔ P.135
- 2 POWER Button ➔ P.180
- 3  (Vehicle Stability Assist (VSA) System OFF) Button ➔ P.390
Safety Support Switch ➔ P.397, 409, 456
Parking Sensor System Button ➔ P.484
Headlight Adjuster* ➔ P.192
Power Tailgate Button* ➔ P.169
Heated Windscreen Button* ➔ P.200
- 4 Deceleration Paddle Selector (+) ➔ P.367
- 5 Steering Wheel Adjustments ➔ P.202
- 6 Deceleration Paddle Selector (-) ➔ P.367
- 7 Wireless Charger* ➔ P.231
- 8 Climate Control System ➔ P.236
Rear Demister ➔ P.199
Heated Door Mirror Button ➔ P.199
Seat Heater Buttons ➔ P.235
- 9 Audio System ➔ P.246
Navigation System
➔ See the Navigation System Manual
- 10 Hazard Warning Button
- 11 Brightness Control ➔ P.201

Visual Index



- 1 **Headlights/Turn Signals** ➔ P.183, 185
Front Fog Lights* ➔ P.187
Rear Fog Light ➔ P.187
- 2 **Hands-Free Telephone System Buttons**
➔ P.318
Voice Control Buttons* ➔ P.255
- 3  **Button** ➔ P.376, 383, 424
- 4 **LIM Button** ➔ P.376, 383, 424
- 5 **Wipers/Washers** ➔ P.196
- 6 **Adaptive Cruise Control (ACC) with Low Speed Follow Buttons** ➔ P.423
- 7 **Lane Keeping Assist System (LKAS) Button** ➔ P.445
Interval Button ➔ P.436
- 8 **Heated Steering Wheel Button*** ➔ P.234
- 9 **Horn (Press an area around )**
- 10  **(Home) Button** ➔ P.136, 252
- 11 **Left Selector Wheel** ➔ P.136, 252
- 12 **Audio Remote Controls** ➔ P.252

Left-hand Drive Type

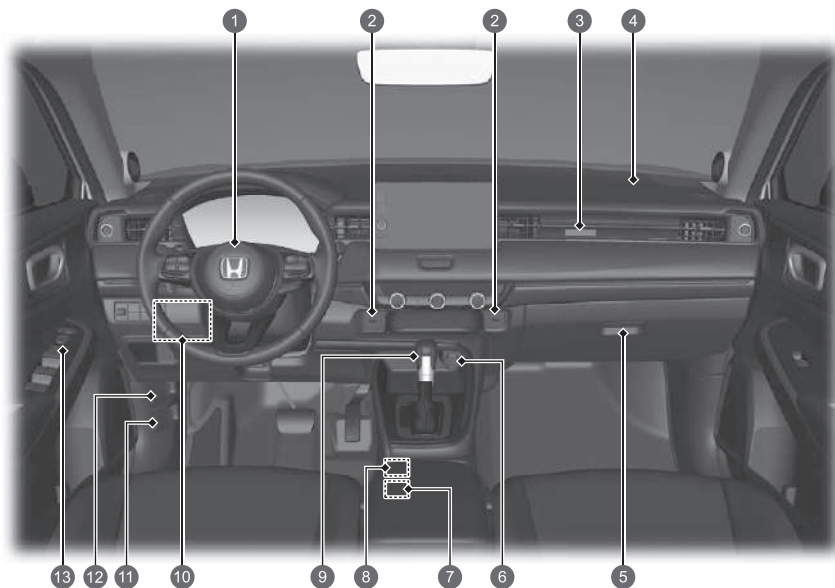

- 1 Driver's Front Airbag ➔ P. 60
- 2 USB Ports ➔ P. 251
- 3 Passenger's Front Airbag OFF Indicator ➔ P. 71
- 4 Passenger's Front Airbag ➔ P. 60
- 5 Glove Box ➔ P. 222
- 6 Accessory Power Socket ➔ P. 230
- 7 Electric Parking Brake Switch ➔ P. 471
Automatic Brake Hold Button ➔ P. 475
- 8 Drive Mode Switch ➔ P. 371
Hill Descent Control Button ➔ P. 375
- 9 Shift Lever ➔ P. 365
- 10 Driver's Side Interior Fuse Box ➔ P. 602
- 11 Bonnet Release Handle ➔ P. 518
- 12 Fuel Fill Door Release Handle ➔ P. 496
- 13 Door Mirror Controls ➔ P. 204
Master Door Lock Switch ➔ P. 161
Power Window Switches ➔ P. 178

Visual Index

Right-hand Drive Type

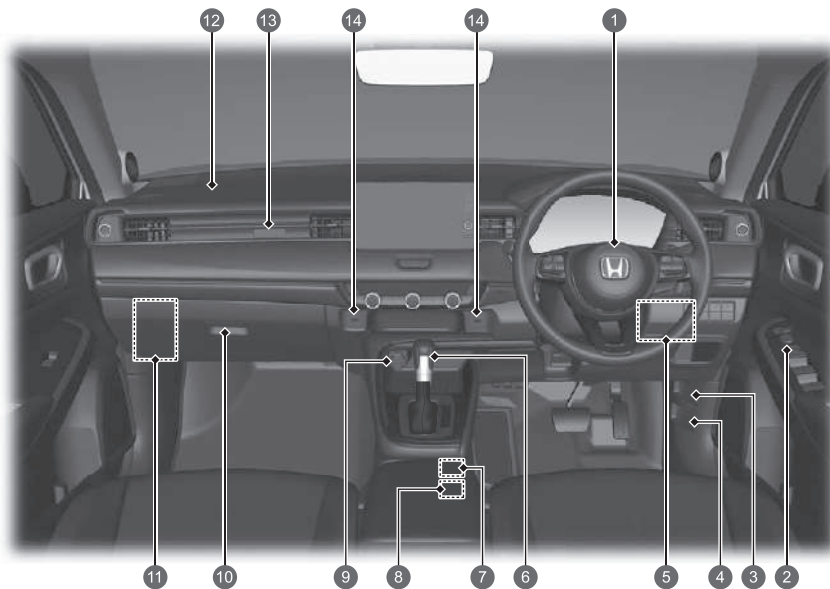

- 1 Driver's Front Airbag → P. 60
- 2 Door Mirror Controls → P. 204
Master Door Lock Switch → P. 161
Power Window Switches → P. 178
- 3 Fuel Fill Door Release Handle → P. 496
- 4 Bonnet Release Handle → P. 518
- 5 Driver's Side Interior Fuse Box → P. 602
- 6 Shift Lever → P. 365
- 7 Drive Mode Switch → P. 371
Hill Descent Control Button → P. 375
- 8 Electric Parking Brake Switch → P. 471
Automatic Brake Hold Button → P. 475
- 9 Accessory Power Socket → P. 230
- 10 Glove Box → P. 222
- 11 Passenger's Side Interior Fuse Box → P. 604
- 12 Driver's Front Airbag → P. 60
- 13 Passenger's Front Airbag OFF Indicator → P. 71
- 14 USB Ports → P. 251

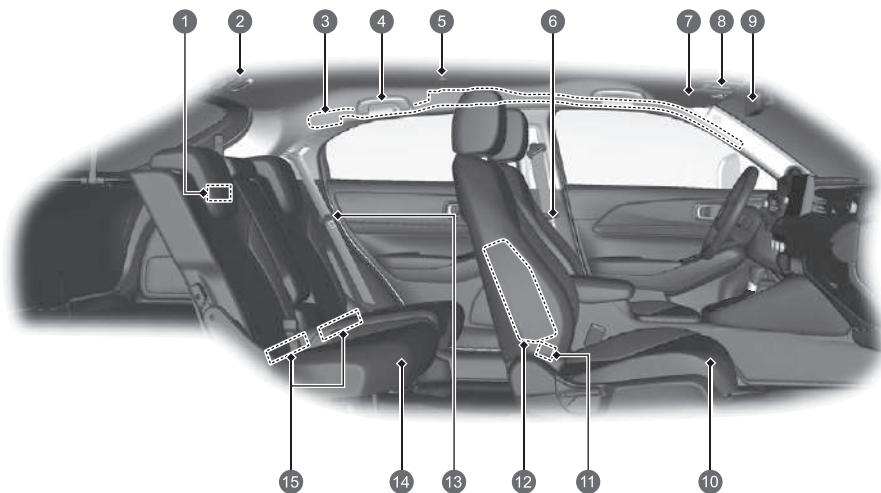

- ① Luggage Area Lights ➔ P. 221
- ② Seat Belt with Detachable Anchorage ➔ P. 53
- ③ Side Curtain Airbags ➔ P. 68
- ④ Grab Handle
Coat Hooks ➔ P. 224
- ⑤ Map Lights ➔ P. 220
- ⑥ Seat Belts ➔ P. 45
- ⑦ Sun Visors ➔ P. 229
Vanity Mirrors
- ⑧ Map Lights ➔ P. 220
SOS Button ➔ P. 346
- ⑨ Rearview Mirror ➔ P. 203
- ⑩ Front Seat ➔ P. 207
- ⑪ USB Ports* ➔ P. 251
- ⑫ Side Airbags ➔ P. 66
- ⑬ Seat Belt (Installing a Child Restraint System) ➔ P. 91
Seat Belt to Secure a Child Restraint System ➔ P. 93
- ⑭ Rear Seat ➔ P. 210
- ⑮ Lower Anchorage Points to Secure a Child Restraint Systems ➔ P. 87

Visual Index

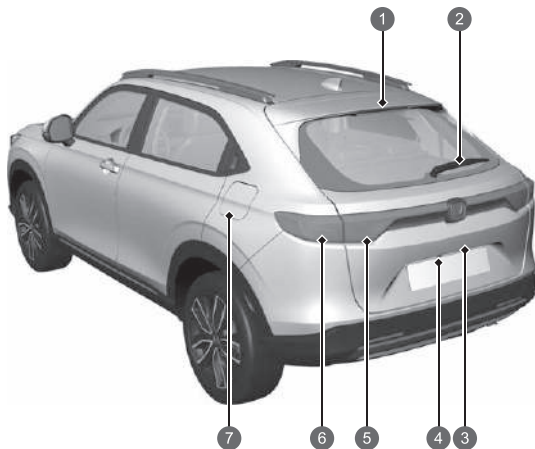
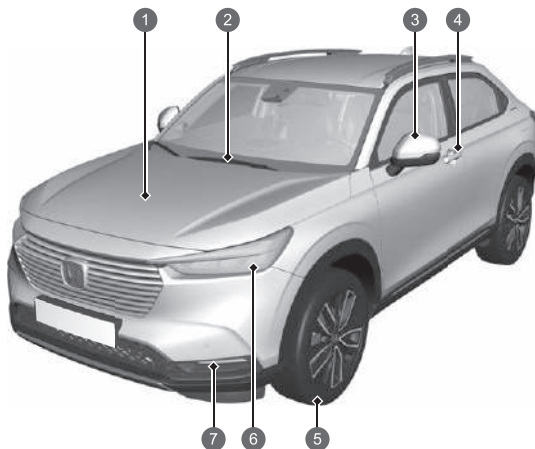

- 1 Maintenance Under the Bonnet ➔ P. 517
 - 2 Windscreen Wipers ➔ P. 196, 536
 - 3 Power Door Mirrors ➔ P. 204
Side Turn Signal Lights ➔ P. 185, 530
 - 4 Door Lock/Unlock Control ➔ P. 154
 - 5 Tyres ➔ P. 541, 569
 - 6 Headlights ➔ P. 183, 530
Position/Daytime Running Lights
➔ P. 183, 189, 530
Front Turn Signal Lights ➔ P. 185, 530
 - 7 Front Fog Lights* ➔ P. 187, 530
-
- 1 High-Mount Brake Light ➔ P. 534
 - 2 Rear Wiper ➔ P. 198, 539
 - 3 Opening/Closing the Tailgate ➔ P. 163
Tailgate Outer Handle ➔ P. 164
Rear Licence Plate Light ➔ P. 183, 534
 - 4 Multi-View Rear Camera ➔ P. 493
 - 5 Taillights ➔ P. 183, 533
Back-Up Lights ➔ P. 533
Rear Fog Light ➔ P. 187, 533
 - 6 Brake/Taillights ➔ P. 183, 531
Rear Turn Signal Lights ➔ P. 185, 531
 - 7 How to Refuel ➔ P. 496

e:HEV

Your e:HEV vehicle uses both an electric motor and a petrol engine as propulsion sources, with the electric motor receiving electricity from an internal High Voltage battery and/or internal generator. The High Voltage battery is charged from the generator driven by the engine or regenerative braking.

When driving, your vehicle is propelled exclusively by the electric motor, exclusively by the petrol engine, or by a combination of the two. The system selects which propulsion source is most appropriate and automatically switches to it.

- **Energy efficiency**

As with a petrol-powered vehicle, hybrid vehicle fuel efficiency and driving range is most impacted by your driving style. Aggressive acceleration and high-speed driving can easily trigger the system to switch the propulsion source to the petrol-powered engine. In addition, heavy climate control system use negatively affects vehicle range and efficiency. Either of these use patterns will more quickly reduce the High Voltage battery's state of charge.

- **Battery types**

There are two types of batteries used in this vehicle; a standard 12-volt battery that powers the airbags, the interior and exterior lights, and other standard 12-volt systems; and a High Voltage battery that is used to power the propulsion motor and recharge the 12-volt battery.

e:HEV MAIN COMPONENTS

Petrol Engine– Runs the generator and under certain conditions, drives the wheels directly.

Generator– Starts the engine and generates electric power when driven by the petrol engine to supply electricity to power the electric motor and/or to charge the High Voltage battery.

Electric Motor– Provides propulsion to drive the wheels in conjunction with the petrol engine in certain conditions, and provides electricity to the High Voltage battery through regenerative braking.

High Voltage Battery– Provides electrical storage and serves as a power source for the electric motor.

Learning about the High Voltage battery's characteristics will help you get the best handling and maximise the range of your electric vehicle. ➔ P.399

High Voltage Battery Charge Level Indicator– Displays battery state of charge.

When the indicator:

- Displays two or less segments, EV mode is no longer available.
- Displays ten segments, battery charge level is full.

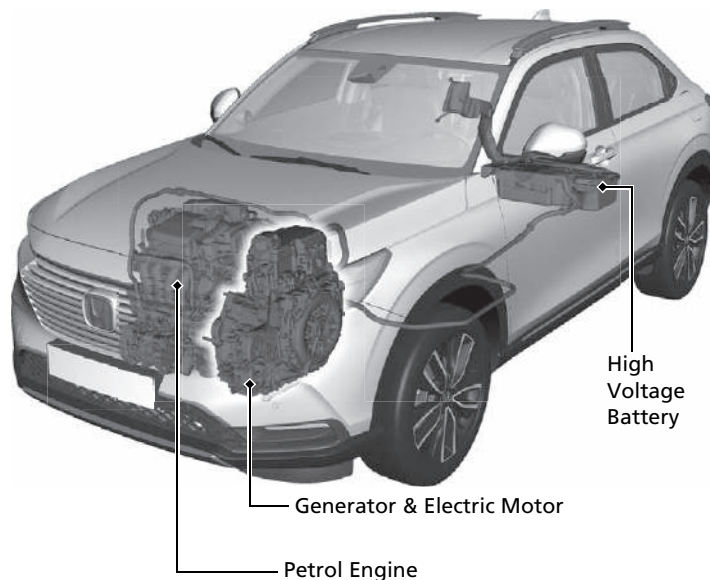



Operating mode	Electric Vehicle (EV)	Hybrid (HV)	Engine (Direct Drive)	Regeneration
Driving state	<p>Stopped or driven at low speeds:</p> <ul style="list-style-type: none"> Only the electric motor provides propulsion to the wheels. 	<p>Driven in high-load conditions (e.g., when accelerating, going uphill):</p> <ul style="list-style-type: none"> The Electric Motor provides propulsion to the wheels. The petrol engine drives the generator, supplying electricity to the electric motor for added propulsion or to the High Voltage battery for charging. 	<p>Driven in high-speed, low-load conditions:</p> <ul style="list-style-type: none"> The petrol engine provides propulsion to the wheels. The High Voltage battery supplies electricity to the electric motor for added propulsion. The electric motor provides electricity to the High Voltage battery through regenerative braking. 	<p>The accelerator pedal is released and the vehicle is decelerating.</p> <ul style="list-style-type: none"> The electric motor provides electricity to the High Voltage battery through regenerative braking.
Power Flow Monitor				
Electric motor	Stopped/Running	Running	Generating/Running	Regenerating
Generator	Stopped	Generating	No Output	Stopped/No Output
Engine	Stopped	Running	Running	Stopped/No Output
High Voltage battery	Discharge	Charging/Discharge	Charging/Discharge	Charging

● Regenerative Energy and Regenerative Braking

When regenerative braking is in operation

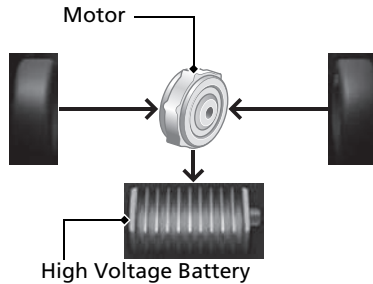

When decelerating without the accelerator being depressed or the brake pedal being applied, or while driving downhill, the electric motor acts as a generator that recovers a portion of the electrical energy that was used to accelerate the vehicle. This regenerative braking slows the vehicle in a manner similar to engine braking in a petrol-powered vehicle. This function is enhanced when the shift lever is moved to **B**.

● Auto Engine Stop/Start

Your vehicle's petrol engine automatically stops running during vehicle operation or restarts while the vehicle is stationary when it is appropriate.

In the following cases, however, auto engine stop may not activate.

- The vehicle momentarily needs additional power for aggressive acceleration, or driving uphill or at high speed.
- The climate control system is in heavy use.
- The High Voltage battery temperature is high or low.
- The High Voltage battery is too low on charge.

● Sounds Unique to the e:HEV

When you first start driving this vehicle, you will likely hear some unfamiliar sounds, particularly when you turn on the power system, or while you are driving or accelerating from a stop. Some of these sounds are unique to this vehicle's powertrain, fuel, and climate control, and High Voltage battery cooling systems; others are similar to sounds generated by conventional automobiles that typically are masked by louder noises absent from a vehicle of this design. These sounds are not a cause for concern, and you will soon recognise them as normal and thus be able to detect any new or unusual noise should one develop.

Safety Precautions



Do not cover the air intake

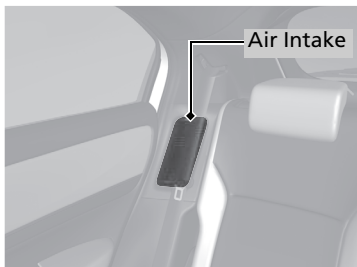

If the air intake is obstructed during vehicle operation, the High Voltage battery can become too hot. To protect the battery, the system may start to limit the battery's output and cause the power system and 12-volt battery charging system indicators to come on.

Do not touch the High Voltage system

Attempting to take a High Voltage system component apart or disconnect one of its wires can cause severe electrical shock. Make sure that any maintenance or repairs to the High Voltage system is performed by a Honda dealer.

If a crash occurs

- Be careful of electric shock hazard.
 - ▶ If a severe crash damages your vehicle's High Voltage system, there is a possibility of electrical shock due to exposed High Voltage components or wires. If this happens, do not touch any of the High Voltage system components or any of its orange wires.
- Avoid contact with High Voltage battery fluid.
 - ▶ The High Voltage battery contains a flammable electrolyte that could leak as a result of a severe crash. Avoid skin or eye contact with the electrolyte as it is corrosive. If you accidentally come into contact with the electrolyte, rinse the exposed skin or flush your eyes with copious amounts of water for at least five minutes, and seek medical attention immediately.
- Use a fire extinguisher for an electrical fire.
 - ▶ Attempting to extinguish an electrical fire with even a small quantity of water, from a garden hose for instance, can be dangerous.
- Anytime the vehicle is damaged in a crash, have it repaired by a dealer.

Emergency Shutdown System for the High Voltage System

If the vehicle is involved in a crash, the emergency shutdown system will activate depending on the severity of the impact. When the system activates, the High Voltage system automatically shuts down, and the vehicle can no longer move under its own power. To return the High Voltage system back to normal operation, consult a dealer.

When the vehicle is disposed

- The High Voltage battery is a Lithium ion battery. Honda collects and recycles used High Voltage batteries – consult with your dealer for proper battery disposal in the event your vehicle is not repairable.

Safe Driving P.39

Airbags P.58

- Your vehicle is fitted with airbags to help to protect you and your passengers during a moderate-to-severe collision.

Child Safety P.73

- All children 12 and younger should be seated in the rear seat.
- Small children should be properly restrained in a front-facing child restraint system.
- Infants must be properly restrained in a rear-facing child restraint system on a rear seat.

Exhaust Gas Hazard P.98

- Your vehicle emits dangerous exhaust gases that contain carbon monoxide. Do not run the engine in confined spaces where carbon monoxide gas can accumulate.

Seat Belts P.45

- Fasten your seat belt and sit upright well back in the seat.
- Check that your passengers are wearing their seat belts correctly.

Before Driving Checklist P.44

- Before driving, check that the front seats, head restraints, steering wheel, and mirrors have been properly adjusted.

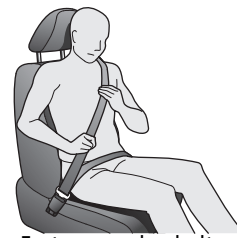
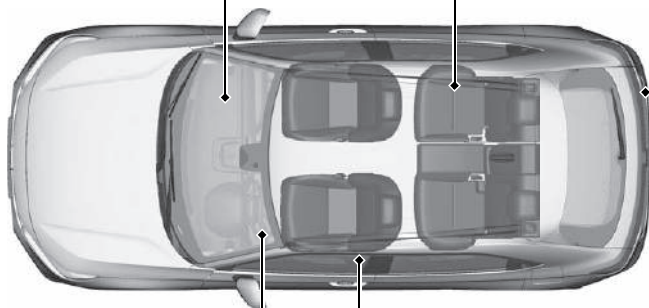

Fasten your lap belt as low as possible.

Instrument Panel [P.101](#)

Indicators [P.102](#) / Gauges [P.132](#) / Driver Information Interface [P.135](#)

Traffic Sign Recognition System [P.134](#)

POWER/CHARGE Gauge [P.132](#)

Ambient Meter [P.133](#)

Speedometer [P.132](#)

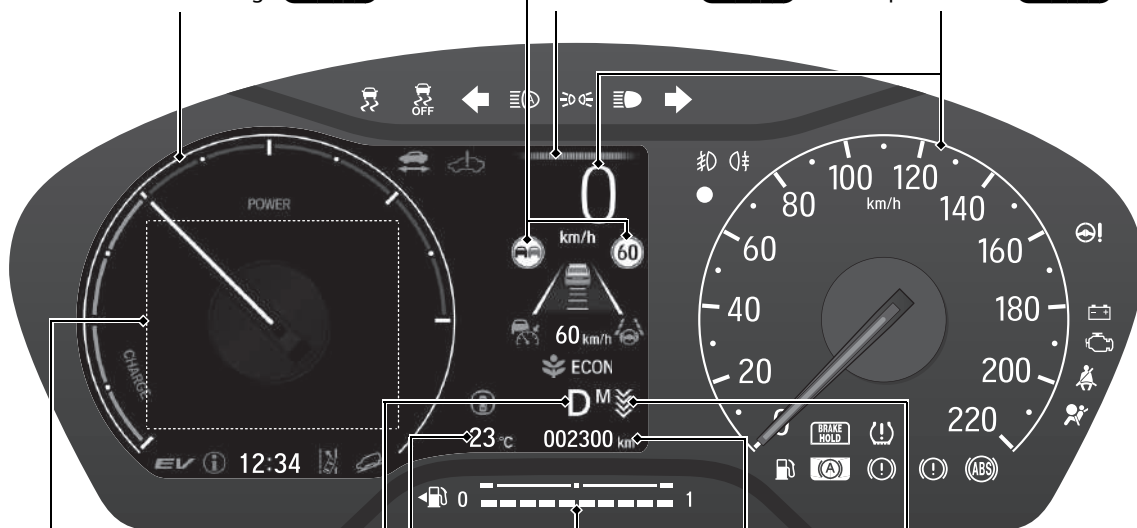

Driver Information Interface [P.135](#)

Fuel Gauge [P.132](#)

Deceleration Paddle Selector Indicator [P.108](#)

Outside Temperature [P.133](#)

Odometer [P.133](#)

Shift Position Indicator [P.108](#) /

Transmission System Indicator [P.108](#)

Controls P.149

Clock P.150

You can adjust the clock and customize the clock display.

 P.266

POWER Button P.180

Press the button to change the vehicle's power mode.

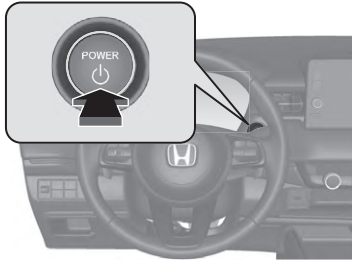

Turn Signals P.185

Turn Signal Control Lever

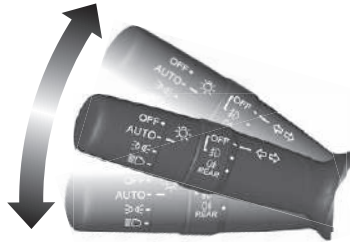

Lights P.183

Light Control Switches

High Beam

Low Beam

Flashing the high beams



Wipers and Washers

 P.196

Wiper/Washer Control Lever

MIST

OFF

AUTO: Wiper speed varies automatically

LO: Low speed wipe

HI: High speed wipe

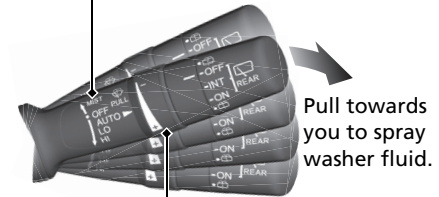

Adjustment Ring

: Low sensitivity

: High sensitivity

AUTO should always be turned **OFF** before the following situations in order to prevent severe damage to the wiper system:

- Cleaning the windshield
- Driving through a car wash
- No rain present

Steering Wheel P.202

- To adjust, pull the adjustment lever towards you, adjust to the desired position, then lock the lever back in place.

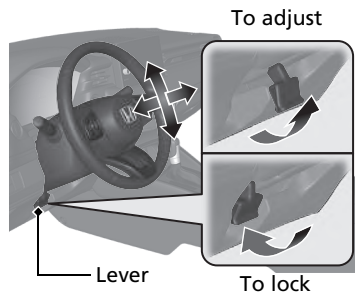

Unlocking the Front Doors from the Inside

 P.160

- Pull either front door inner handle to unlock and open it at the same time.

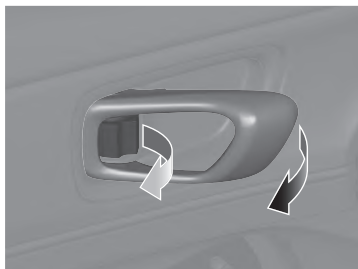

Tailgate P.163

- Press the outer handle to unlock and open the tailgate when you carry the keyless remote on you.

Models with power tailgate

- Press the power tailgate button on the driver's side control panel.
- Press the power tailgate button on the remote transmitter.



Models with Hands Free Access

With the keyless remote on you, raise and lower your foot (in a kicking motion) under the centre of the rear bumper to open or close the tailgate.

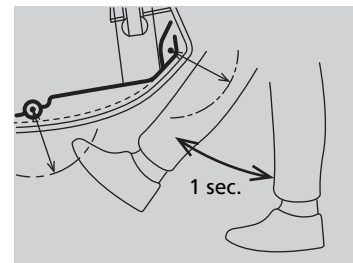

Power Door Mirrors

➔ P.204

- With the power mode in ON, move the selector switch to **L** or **R**.
- Push the appropriate edge of the adjustment switch to adjust the mirror.
- Press the folding door mirror button to fold in and out the door mirrors.

Folding Door Mirror Button

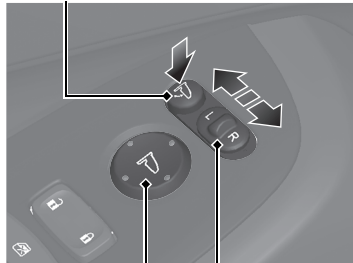

Adjustment Switch

Selector Switch

Power Windows ➔ P.177

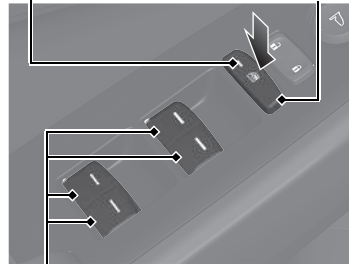

- With the power mode in ON, open and close the power windows.
- If the power window lock button is in the off position, each passenger's window can be opened and closed with its own switch.
- If the power window lock button is in the on position (indicator on), each passenger's window switch is disabled.

Indicator Power Window Lock Button



Window Switch

Climate Control System P.236

- Press the **AUTO** button to activate the climate control system.
- Press the  button to turn the system on or off.
- Press the  button to defrost the windscreen.

Models without SYNC button

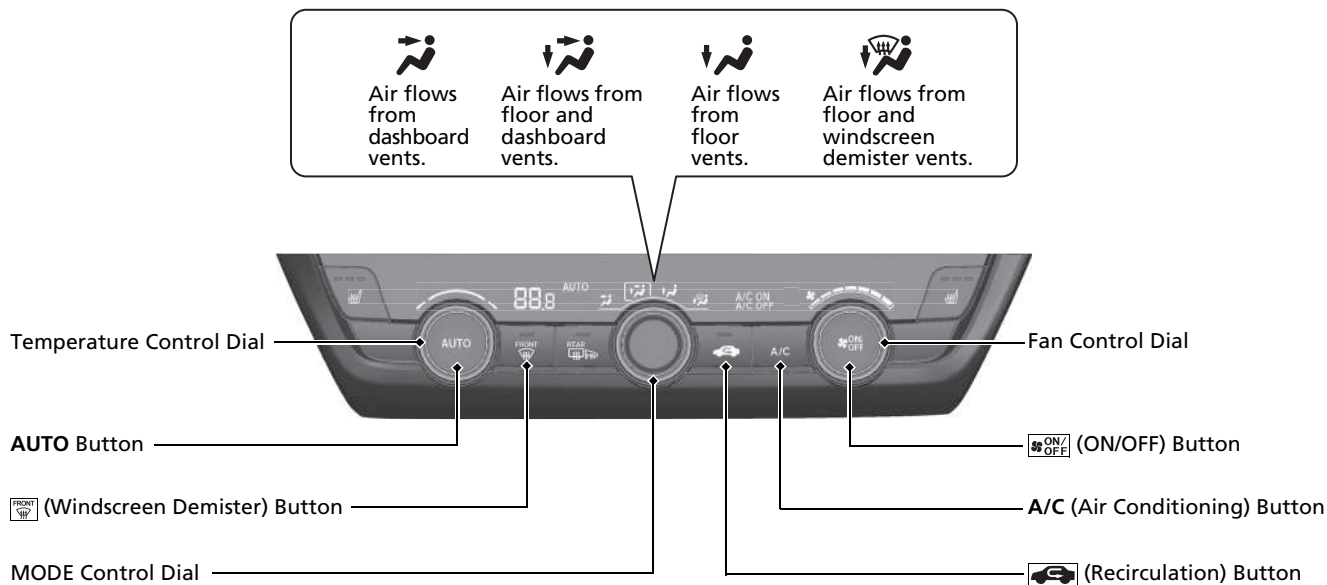

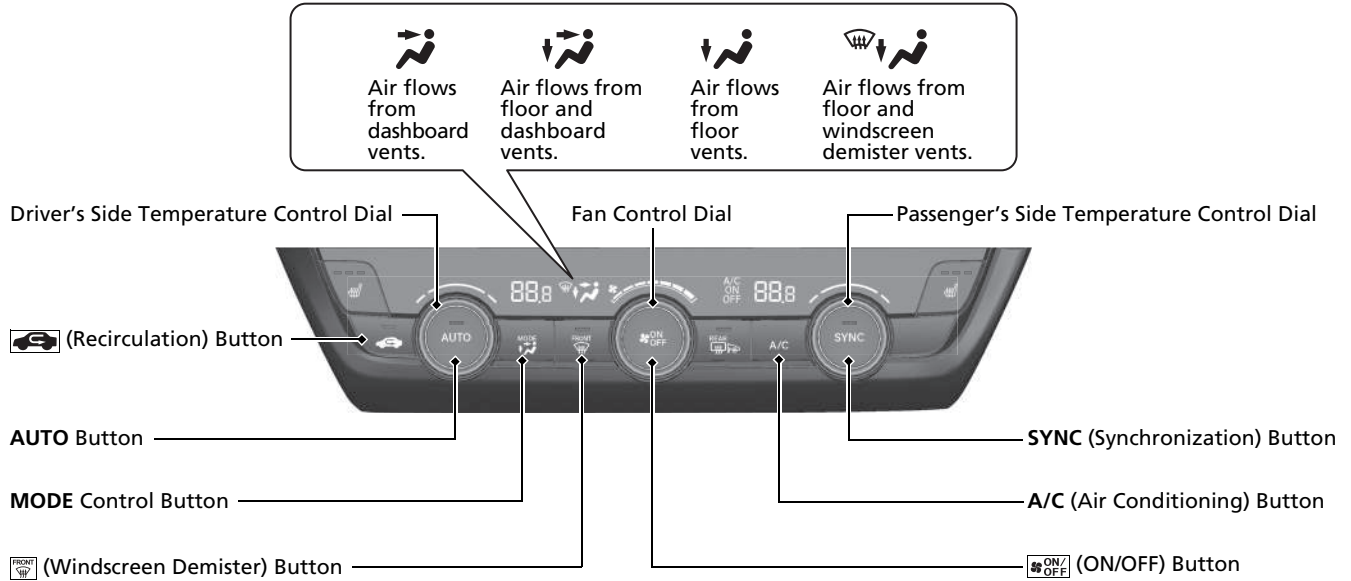

Features P.245

Audio System P.246, 248

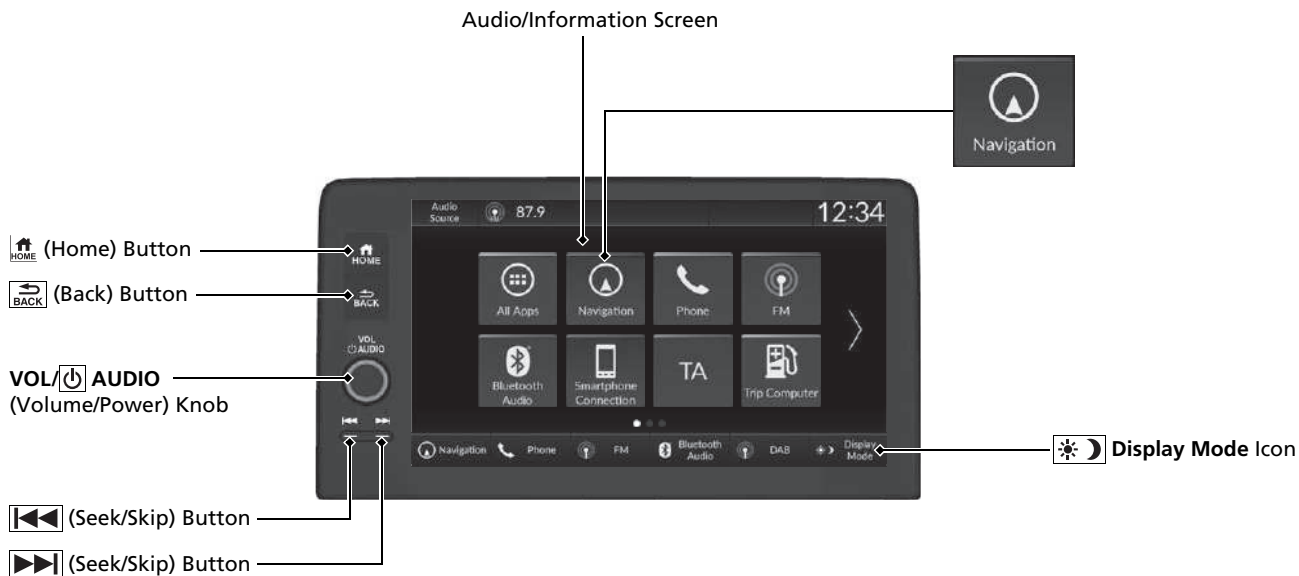

For navigation system operation  See the Navigation System Manual



Audio Remote Controls

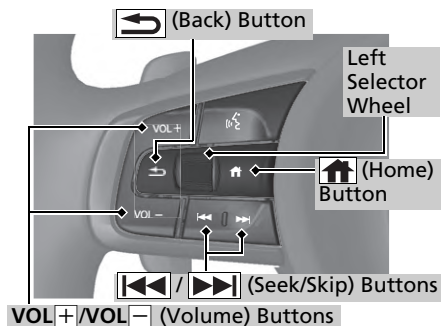





➔ P.252



- **VOL+**/**VOL-** (Volume) Buttons
Press to adjust the volume up/down.
- **Left Selector Wheel**
When selecting the audio mode
Press the  (home) button, then roll up or down to select  (audio) on the driver information interface, and then press the left selector wheel.

Roll up or down: To cycle through the audio modes, roll up or down and then press the left selector wheel:
FM/AM/DAB/iPod/USB/Apple CarPlay/
Android Auto/*Bluetooth*® Audio

Depending on a connected device, the displayed modes may be changed.

- ** (Seek/Skip) Buttons**
Radio: Press  to change the preset radio station.
iPod, USB device, *Bluetooth*® Audio or Smartphone Connection:
Press  to skip to the beginning of the next song or return to the beginning of the current song.
Radio: Press and hold  to change the strong station.
USB device:
Press and hold  to change a folder.
iPod: Press and hold  to change a song.

Depending on a connected device, operations may be changed.

Driving P. 351

Transmission P. 364, 365

- Shift to **P** and depress the brake pedal when turning on the power.

Shift selection

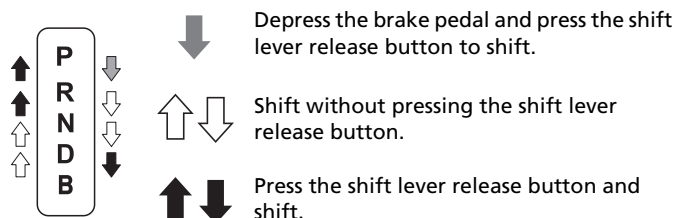

P **Park**
Used when parking or before turning the power on or off.
Transmission is locked.

R **Reverse**
Used when reversing.

N **Neutral**
Transmission is not locked.

D **Drive**
Used for normal driving.

- The deceleration paddle selector can be used temporarily.
- The deceleration paddle selector can be used when SPORT mode is on.

B **Drive (B)**

- Used when driving down a long hill and to increase regenerative braking.
- The deceleration paddle selector can be used.

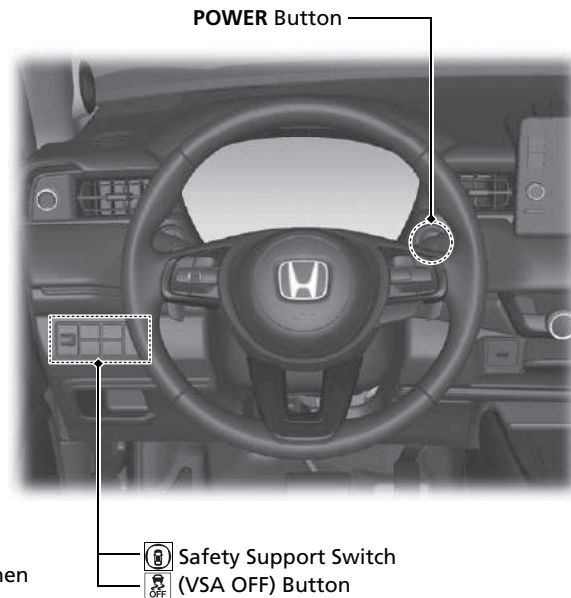

Deceleration Paddle Selector P. 367

When you release the accelerator pedal, you can control the rate of deceleration without releasing your hands from the steering wheel. Using the deceleration paddle selector situated on the steering wheel, you can sequentially shift through four stages of deceleration.

- **When shift position is in **

If you pull back the paddle selector, the rate of deceleration will change temporarily, and the stage will appear in the instrument panel.

- **When shift position is in  and SPORT mode is ON or when shift position is in **

If you pull back the paddle selector, the rate of deceleration will change and the stage along with **M** will appear in the instrument panel.



 Paddle Selector





 Paddle Selector

When shift position is in , the deceleration stage appears.



Deceleration stage

When shift position is in  and SPORT mode is ON or when shift position is in , the deceleration stage and **M** appear.

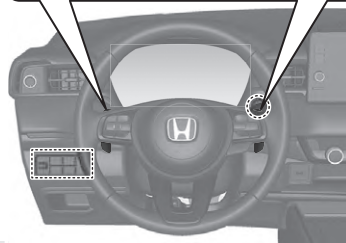

CMBS On and Off P.409

- When a possible frontal collision is likely unavoidable, the CMBS can help you to reduce the vehicle speed and the severity of the collision.
- The CMBS is turned on every time you start the power system.
- To turn the CMBS on or off, use the safety support switch.

VSA On and Off P.390

- The Vehicle Stability Assist (VSA) system helps to stabilise the vehicle during cornering, and helps to maintain traction while accelerating on loose or slippery road surfaces.
- VSA comes on automatically every time you start the power system.
- To partially disable or fully restore VSA function, press and hold the  button until you hear a beep.

Deflation Warning System P.392

- Detects a change in tyre conditions and overall dimensions due to decrease in tyre pressures.
- The Deflation Warning System is turned on automatically every time you turn on the power system.
- A calibration procedure must be performed when certain conditions arise.

Adjustable Speed Limiter

P.376

This system enables you to set a maximum speed that cannot be exceeded even if you are depressing the accelerator pedal.

- To use the adjustable speed limiter, press the  button. Select the adjustable speed limiter by pressing the **LIM** button, then press the **SET/-** button when your vehicle reaches the desired speed.
- The vehicle speed limit can be set from 30 km/h (18 mph) to 250 km/h (156 mph).

Refueling P. 495

Fuel recommendation: EN 228 standards petrol/gasohol fuel
Unleaded premium petrol/gasohol up to E10 (90% petrol and 10% ethanol), research octane number 95 or higher

Fuel tank capacity: 40 L (8.8 Imp gal)

- 1** Pull the fuel fill door release handle.

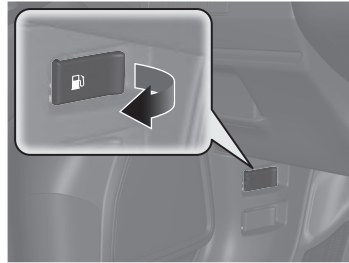

- 2** Turn the fuel fill cap slowly to remove the cap.



- 3** Place the cap in the holder on the fuel fill door.



- 4** After refueling, screw the cap back on until it clicks at least once.



Honda Sensing [P. 402](#)

Honda Sensing is a driver support system which employs the use of two distinctly different kinds of sensors, a front wide view camera mounted to the interior side of the windshield, behind the rearview mirror, and the sonar sensors located in the front and rear bumpers.

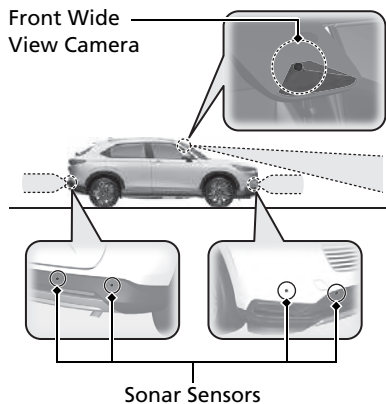

Collision Mitigation Braking System (CMBS) [P. 405](#)

The system can assist you when it determines there is a possibility of your vehicle colliding with a vehicle (including motorcycles) ahead from behind, an oncoming vehicle in front, a pedestrian, or someone riding a bicycle (moving bicycle). The CMBS is designed to alert you when the potential for a collision is determined, as well as assist in reducing speed, avoiding collisions, and reducing collision severity.

Low Speed Braking Control [P. 417](#)

Using sonar sensors located on the front and rear bumpers, this system detects if there is danger of a potential collision with a wall or other obstacle during normal driving or when the accelerator pedal is depressed with too much force. The system then assists in avoiding collisions and reducing damage from impact through assistive braking and/or assistive driving power suppression.

Adaptive Cruise Control (ACC) with Low Speed Follow [P. 423](#)

Helps to maintain a constant vehicle speed and a set following-interval behind a vehicle detected ahead of yours and, if the detected vehicle comes to a stop, can decelerate and stop your vehicle, without you having to keep your foot on the brake or the accelerator.

Lane Keeping Assist System (LKAS) [P. 441](#)

Provides steering input to help to keep the vehicle in the middle of a detected lane and provides tactile, audible and visual alerts if the vehicle is detected drifting out of its lane.

Road Departure Mitigation System P. 453

Alerts and helps to assist you when the system detects a possibility of your vehicle crossing over detected lane markings, or approaching the outer edge of the pavement (into grass or gravel border) or an oncoming vehicle.

Traffic Sign Recognition System P. 461

Reminds you of road sign information, such as the current speed limit and that overtaking is prohibited, your vehicle has just passed through, showing it on the gauge.

Maintenance ↔ P. 499

Under the Bonnet ↔ P. 517

- Check engine oil, engine coolant, and windscreen washer fluid. Add when necessary.
- Check brake fluid.
- Check the 12-volt battery condition monthly.

- 1** Pull the bonnet release handle under the corner of the dashboard.

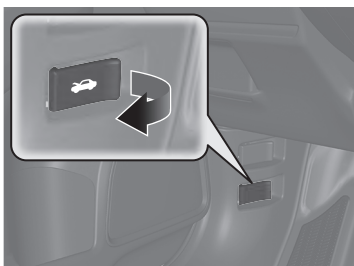

- 2** Locate the bonnet latch lever, push it to the side, and then raise the bonnet. Once you have raised the bonnet slightly, you can release the lever.

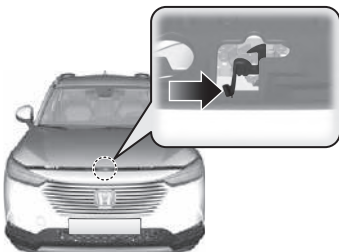

- 3** When finished, close the bonnet and make sure it is firmly locked in place.

Wiper Blades ↔ P. 536

- Replace blades if they leave streaks across the windscreen or become noisy.



Tyres ↔ P. 541

- Inspect tyres and wheels regularly.
- Check tyre pressures regularly.
- Install winter tyres for winter driving.

Lights ↔ P. 530

- Inspect all lights regularly.

Handling the Unexpected P.567

Flat Tyre P.569

- Park in a safe location and repair the flat tyre using the tyre repair kit.



Power System Won't Start P.583

- If the 12-volt battery is dead, jump start using a booster battery.

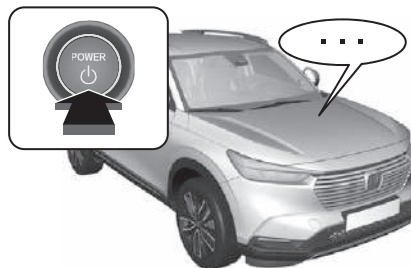

Overheating P.591

- Park in a safe location. If you do not see steam under the bonnet, open the bonnet, and let the power system cool down.



Indicators Come On P.593

- Identify the indicator and consult the owner's manual.

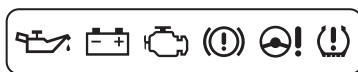

Blown Fuse P.600

- Check for a blown fuse if an electrical device does not operate.

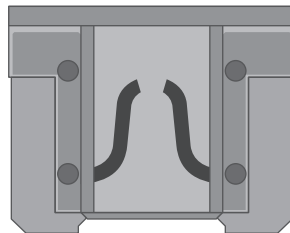

Emergency Towing P.606

- Call a professional towing service if you need to tow your vehicle.



What to Do If

Q The power mode does not change from VEHICLE OFF (LOCK) to ACCESSORY. Why?

- A**
- The steering wheel may be locked.
 - Move the steering wheel left and right after pressing the **POWER** button.



Q The power mode does not change from ACCESSORY to VEHICLE OFF (LOCK). Why?

- A** The shift lever should be moved to **P**.



Q Why does the brake pedal pulsate slightly when applying the brakes?

- A** This can occur when the ABS activates and does not indicate a problem. Apply firm, steady pressure on the brake pedal. Never pump the brake pedal.
- Anti-lock Brake System (ABS) ➔ P. 478

Q The rear door cannot be opened from inside the vehicle. Why?

A Check if the childproof lock is in the lock position. If so, open the rear door with the outside door handle. To cancel this function, slide the lever up to the unlock position.



Q Why do the doors lock after I unlocked the doors?

A If you do not open the doors within 30 seconds, the doors are relocked automatically for security.

Q Why does the beeper sound when I open the driver's door?

A The beeper sounds when:

- The power mode is in ACCESSORY.
- The exterior lights are left on.

Q Why does the beeper sound when I start driving?

A The beeper sounds when the driver and/or front passenger are not wearing their seat belts.

Q Pressing the electric parking brake switch does not release the parking brake. Why?

A Press the electric parking brake switch with the brake pedal depressed.

Q I'm seeing an amber indicator of a tyre with an exclamation point. What is that?

A The Deflation Warning System needs attention. If you recently inflated or changed a tyre, you have to recalibrate the system.
🔧 Deflation Warning System ➔ P.392

Q Depressing the accelerator pedal does not release the parking brake automatically. Why?

A

- Fasten the driver's seat belt.
- Check if the transmission is in **P** or **N**. If so, select any other position.

Q Why do I hear a screeching sound when I apply the brake pedal?

A The brake pads may need to be replaced. Have your vehicle inspected by a dealer.

Q Is it possible to use unleaded petrol with a Research Octane Number (RON) of 91 or higher on this vehicle?

A Your vehicle is designed to operate on premium unleaded petrol with a research octane of 95 or higher. If this octane grade is unavailable, regular unleaded petrol with a research octane of 91 or higher may be used temporarily. The use of regular unleaded petrol can cause metallic knocking noises in the engine and will result in decreased engine performance. The long-term use of regular-grade petrol can lead to engine damage.

Safe Driving

You can find many safety recommendations throughout this chapter, and throughout this manual.

For Safe Driving

Important Safety Precautions.....	40
Important Handling Information.....	42
Your Vehicle's Safety Features.....	43
Safety Checklist	44

Seat Belts

About Your Seat Belts	45
Fastening a Seat Belt	50
Seat Belt Inspection.....	56
Anchorage Points.....	57

Airbags

Airbag System Components.....	58
-------------------------------	----

Types of Airbags	60
Front Airbags (SRS)	60
Side Airbags.....	66
Side Curtain Airbags	68
Airbag System Indicators.....	70
Airbag Care	72

Child Safety

Protecting Child Passengers	73
Safety of Infants and Small Children...	76
Safety of Larger Children	95

Exhaust Gas Hazard

Carbon Monoxide Gas	98
---------------------------	----

Safety Labels

Label Locations	99
-----------------------	----

The following pages explain your vehicle's safety features and how to use them properly. The safety precautions below are ones that we consider to be among the most important.

Important Safety Precautions

■ Always wear your seat belt

A seat belt is your best protection in all types of collisions. Airbags are designed to supplement seat belts, not replace them. So even though your vehicle is equipped with airbags, make sure you and your passengers always wear your seat belts, and wear them properly.

■ Restrain all children

Children aged 12 and under should ride properly restrained in a back seat, not the front seat. Infants and small children should be restrained in a child restraint system. Larger children should use a booster seat and a lap/shoulder seat belt until they can use the belt properly without a booster seat.

■ Be aware of airbag hazards

While airbags can save lives, they can cause serious or fatal injuries to occupants who sit too close to them, or are not properly restrained. Infants, young children, and short adults are at the greatest risk. Be sure to follow all instructions and warnings in this manual.

■ Don't drink and drive

Alcohol and driving don't mix. Even one drink can reduce your ability to respond to changing conditions, and your reaction time gets worse with every additional drink. So don't drink and drive, and don't let your friends drink and drive, either.

ⓘ Important Safety Precautions

Some countries prohibit the use of mobile phones other than hands-free devices by the driver while driving.

■ Pay appropriate attention to the task of driving safely

Engaging in mobile phone conversation or other activities that keep you from paying close attention to the road, other vehicles, and pedestrians could lead to a crash. Remember, situations can change quickly, and only you can decide when it is safe to divert some attention away from driving.

■ Control your speed

Excessive speed is a major factor in crash injuries and deaths. Generally, the higher the speed, the greater the risk, but serious injuries can also occur at lower speeds. Never drive faster than is safe for current conditions, regardless of the maximum speed posted.

■ Keep your vehicle in safe condition

Having a tyre blowout or a mechanical failure can be extremely hazardous. To reduce the possibility of such problems, check your tyre pressures and condition frequently, and perform all regularly scheduled maintenance.

■ Do not leave children unattended in the vehicle

Children, pets, and people needing assistance left unattended in the vehicle may be injured if they activate one or more of the vehicle controls. They may also cause the vehicle to move, resulting in a crash in which they and/or another person(s) can be injured or killed. Also, depending on the ambient temperature, the temperature of the interior may reach extreme levels, which can result in harm or death. Even if the climate control system is on, never leave them in the vehicle unattended as the climate control system can shut off at any time.

Important Handling Information

Your vehicle has higher ground clearance than a passenger vehicle designed for use only on pavement. Higher ground clearance has many advantages for off-road driving. It allows you to travel over bumps, obstacles, and rough terrain. It also provides good visibility so you can anticipate problems earlier.

These advantages come at some cost. Because your vehicle is taller and rides higher off the ground, it has a higher centre gravity making it more susceptible to tipping or rollover if you make abrupt turns. Utility vehicles have a significantly higher rollover rate than other types of vehicles. In a rollover crash, an unbelted person is significantly more likely to die than a person wearing a seat belt. As a reminder, make sure you and your passengers always wear seat belts.

► Important Handling Information

For information on how to reduce the risk of rollover, read:

► **Driving Guidelines for Your Utility Vehicle**
P. 362

► **Off-road Guidelines** P. 357

Failure to operate your vehicle correctly might result in a crash or a rollover.

In many countries, the law prohibits off-road driving, e. g. driving in forests, trailblazing, etc. Please check your local laws and regulations before commencing any off-road driving activity.

Your Vehicle's Safety Features

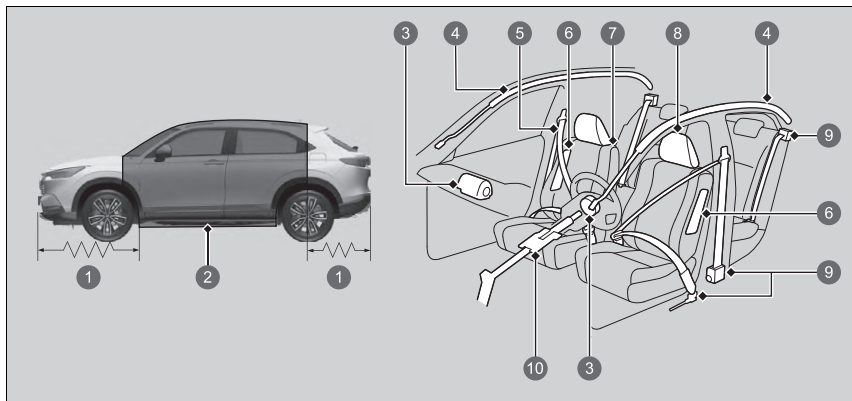

- ① Crush Zones
- ② Safety Cage
- ③ Front Airbags
- ④ Side Curtain Airbags
- ⑤ Seat Belts
- ⑥ Side Airbags
- ⑦ Seats and Seat-Backs
- ⑧ Head Restraints
- ⑨ Automatic Seat Belt Tensioners
- ⑩ Collapsible Steering Column

The following checklist will help you take an active role in protecting yourself and your passengers.

☒ Your Vehicle's Safety Features

Your vehicle is equipped with many features that work together to help to protect you and your passengers during a crash.

Some features do not require any action on your part. These include a strong steel framework that forms a safety cage around the passenger compartment, front and rear crush zones, a collapsible steering column, and tensioners that tighten the front and rear outer seat belts in a sufficient crash.

However, you and your passengers cannot take full advantage of these features unless you remain seated in the correct position and always wear your seat belts. In fact, some safety features can contribute to injuries if they are not used properly.

Safety Checklist

For the safety of you and your passengers, make a habit of checking these items each time before you drive.

- Adjust your seat to a position suitable for driving. Be sure the front seats are adjusted as far to the rear as possible while allowing the driver to control the vehicle. Sitting too close to a front airbag can result in serious or fatal injury in a crash.
 - **Seats** P. 207
- Adjust head restraints to the proper position. Head restraints are most effective when the centre of the head restraint aligns with the centre of your head. Taller persons should adjust their head restraint to the highest position.
 - **Adjusting the Front Head Restraints** P. 215
- Always wear your seat belt, and make sure you wear it properly. Confirm that any passengers are properly belted as well.
 - **Fastening a Seat Belt** P. 50
- Protect children by using seat belts or child restraint systems according to a child's age, height, and weight.
 - **Child Safety** P. 73

☒ Safety Checklist

If the door and/or tailgate open message appears on the driver information interface, a door and/or the tailgate is not completely closed. Close all doors and the tailgate tightly until the message disappears.

➤ **Driver Information Interface Warning and Information Messages** P. 120

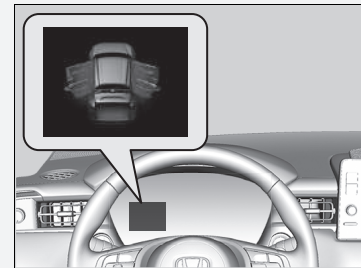

About Your Seat Belts

Seat belts are the single most effective safety device because they keep you connected to the vehicle so that you can take advantage of many built-in safety features. They also help to keep you from being thrown against the inside of the vehicle, against any passengers, or out of the vehicle. When worn properly, seat belts also keep your body properly positioned in a crash so that you can take full advantage of the additional protection provided by the airbags.

In addition, seat belts help to protect you in almost every type of crash, including:

- frontal impacts
- side impacts
- rear impacts
- rollovers

⌘ About Your Seat Belts

⚠ WARNING

Not wearing a seat belt properly increases the chance of serious injury or death in a crash, even though your vehicle has airbags.

Be sure you and your passengers always wear seat belts and wear them properly.

WARNING: Seat belts are designed to bear upon the bony structure of the body, and should be worn low across the front of the pelvis or the pelvis, chest and shoulders, as applicable; wearing the lap section of the belt across the abdominal area must be avoided.

WARNING: Seat belts should be adjusted as firmly as possible, consistent with comfort, to provide the protection for which they have been designed. A slack belt will greatly reduce the protection afforded to the wearer.

WARNING: Belts should not be worn with straps twisted.

WARNING: Each belt assembly must only be used by one occupant; it is dangerous to put a belt around a child being carried on the occupant's lap.

■ Lap/shoulder seat belts

All five seating positions are equipped with lap/shoulder seat belts with emergency locking retractors. In normal driving, the retractor lets you move freely while keeping some tension on the belt. During a collision or sudden stop, the retractor locks to restrain your body.

The seat belt must be properly secured when using a front-facing child restraint system.

➤ **Child Safety** P. 73

■ Proper use of seat belts

Follow these guidelines for proper use:

- All occupants should sit upright, well back in the seat, and remain in that position for the duration of the trip. Slouching and leaning reduce the effectiveness of the belt and can increase the chance of serious injury in a crash.
- Never place the shoulder part of a lap/shoulder seat belt under your arm or behind your back. This could cause very serious injuries in a crash.
- Two people should never use the same seat belt. If they do, they could be very seriously injured in a crash.
- Do not put any accessories on the seat belts. Devices intended to improve comfort or reposition the shoulder part of a seat belt can reduce the protective capability and increase the chance of serious injury in a crash.

➤ About Your Seat Belts

If you extend the seat belt too quickly, it will lock in place. If this happens, slightly retract the seat belt, then extend it slowly.

Seat belts cannot completely protect you in every crash. But in most cases, seat belts can reduce your risk of serious injury.

Most countries require you to wear seat belts. Take time to familiarise with the legal requirements of the countries in which you will drive.

Seat Belt Reminder

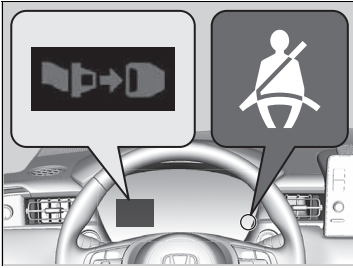

Front seats

The seat belt system includes an indicator on the instrument panel to remind the driver or a front passenger or both to fasten their seat belts.

If you set the power mode to ON and a seat belt is not fastened, the indicator will come on.

The beeper will periodically sound and the indicator will blink if you start driving without fastening a seat belt.

Seat Belt Reminder

The indicator will also come on if a front passenger does not fasten their seat belt within six seconds after the power mode is set to ON.

When no one is sitting in the front passenger's seat, the indicator will not come on and the beeper will not sound.

If the indicator comes on or the beeper sounds with no one sitting in the front passenger's seat. Check if:

- There is nothing heavy placed on the front passenger seat.
- The driver's seat belt is fastened.

If the indicator does not light when the passenger is seated and is not fastened, something may be interfering with the occupant detection sensor.

Check if:

- A cushion is placed on the seat.
- The front passenger is not sitting properly.

If none of these conditions exist, have your vehicle checked by a dealer.

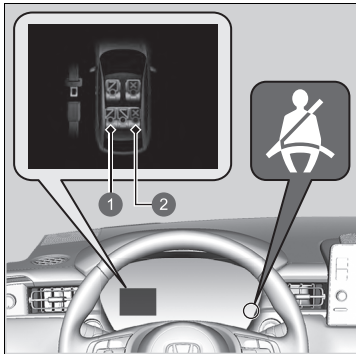

- ① Fastened
- ② Unfastened

■ Rear seats

Your vehicle monitors rear seat belt use. A driver information interface notifies you if any of the rear seat belts are not used.

The display appears when:

- Any of the rear passengers' seat belts are unfastened when the power mode is set to ON.
- A rear door is opened and then closed.
- Any of the rear passengers fastens or unfastens their seat belt.

The seat belt reminder indicator blinks and beeper sounds if any rear passenger's seat belt is unfastened while driving.

Automatic Seat Belt Tensioners

Driver seat

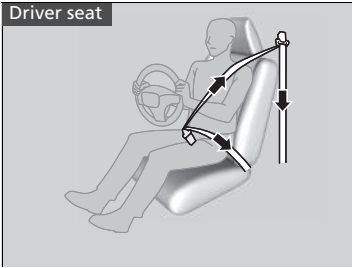

The front seats and the outer rear seats are equipped with automatic seat belt tensioners to enhance safety.

The tensioners automatically tighten the front seat belts and the outer rear seat belts during a moderate-to-severe frontal collision, sometimes even if the collision is not severe enough to inflate the front airbags.

Front passenger and outer rear seats

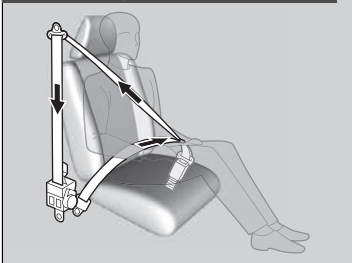

Automatic Seat Belt Tensioners

The seat belt tensioners can only operate once. If a tensioner is activated, the SRS indicator will come on. Have a dealer replace the tensioner and thoroughly inspect the seat belt system as it may not offer protection in a subsequent crash.

During a moderate-to-severe side impact, the tensioner on both sides of the vehicle also activates.

Fastening a Seat Belt

After adjusting a front seat to the proper position, and while sitting upright and well back in the seat (see illustrations for correct seating posture):

➤ **Seats** P. 207



1. Pull the seat belt out slowly.

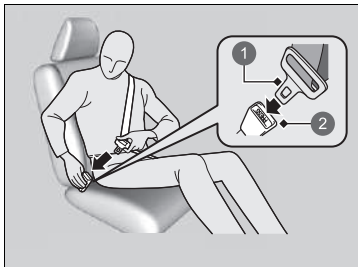

2. Insert the latch plate into the buckle, then tug on the belt to make sure the buckle is secure.

▶ Make sure that the belt is not twisted or caught on anything.

- ① Latch Plate
- ② Buckle

⊗ Fastening a Seat Belt

No one should sit in a seat with an inoperative seat belt or one that does not appear to be working correctly. Using a seat belt that is not working properly may not protect the occupant in a crash. Have a dealer check the belt as soon as possible.

If the seat belt appears to be locked in a fully retracted position, firmly pull out on the shoulder belt once, then push it back in. Then, smoothly pull it out of the retractor and fasten. If you are unable to release the seat belt from a fully retracted position, do not allow anyone to sit in the seat, and take your vehicle to a dealer for repair.

➤ **About Your Seat Belts** P. 45

➤ **Seat Belt Inspection** P. 56



3. Position the lap part of the belt as low as possible across your hips (see illustration), then pull up on the shoulder part of the belt so the lap part fits snugly. This lets your strong pelvic bones take the force of a crash and reduces the chance of internal injuries.
4. If necessary, pull up on the belt again to remove any slack, then check that the belt rests across the centre of your chest and over your shoulder. This spreads the forces of a crash over the strongest bones in your upper body.

Fastening a Seat Belt

⚠ WARNING

Improperly positioning the seat belts can cause serious injury or death in a crash.

Make sure all seat belts are properly positioned before driving.

To release the belt, push the red **PRESS** button and then guide the belt by hand until it has retracted completely.

When exiting the vehicle, be sure the belt is properly stowed so that it will not get caught in the closing door.

Never insert any foreign objects into the buckle or retractor mechanism.

■ Adjusting the Shoulder Anchorage

The front seats have adjustable shoulder anchorages to accommodate taller and shorter occupants.



1. Move the anchorage up and down while pulling the shoulder anchorage outward.
2. Position the anchorage so that the belt rests across the centre of your chest and over your shoulder.

▣ Adjusting the Shoulder Anchorage

After an adjustment, make sure that the shoulder anchorage position is secure.

The shoulder anchorage height can be adjusted to four levels. If the belt contacts your neck, lower the height one level at a time.

Seat Belt with Detachable Anchorage

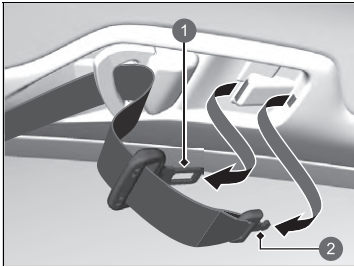

- ① Latch Plate
- ② Small Latch Plate

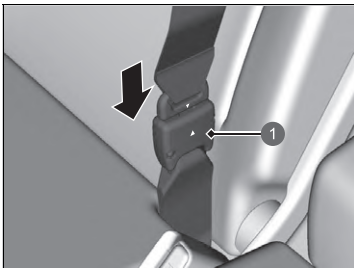

- ① Anchorage Buckle

1. Pull out the seat belt's small latch plate and the latch plate from each holding slot in the ceiling.

2. Line up the triangle marks on the small latch plate and anchorage buckle. Make sure the seat belt is not twisted. Attach the belt to the anchorage buckle.

Seat Belt with Detachable Anchorage

⚠ WARNING

Using the seat belt with the detachable anchorage unlatched increases the chance of serious injury or death in a crash.

Before using the seat belt, make sure the detachable anchorage is correctly latched.

To unlatch the detachable anchorage, insert the latch plate into the slot on the side of the anchorage buckle.

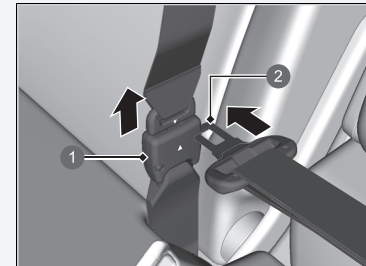

- ① Anchorage Buckle
- ② Latch Plate

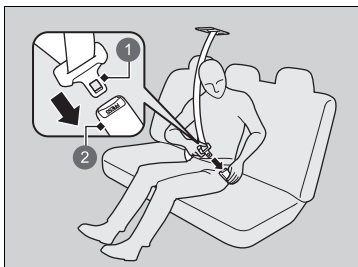

- ① Latch Plate
- ② Buckle

3. Insert the latch plate into the buckle.
Properly fasten the seat belt the same way
you fasten the lap/shoulder seat belt.

Advice for Pregnant Women

Consider alternative:

If you are pregnant, the best way to protect yourself and your unborn child when driving or riding in a vehicle is to always wear a seat belt. When positioning the seat belt, wear the shoulder belt section across the chest, avoiding the abdomen, and keep the lap belt portion as low as possible across the hips. (See illustration.)



Advice for Pregnant Women

Each time you have a checkup, ask your doctor if it is okay for you to drive.

To reduce the risk of injuries to both you and your unborn child that can be caused by an inflating front airbag:

- When driving, sit upright and adjust the seat as far back as possible while allowing full control of the vehicle.
- When sitting in the front passenger's seat, adjust the seat as far back as possible.

Seat Belt Inspection

Regularly check the condition of your seat belts as follows:

- Pull each belt out fully, and look for frays, cuts, burns, and wear.
- Check that the latch plates and buckles work smoothly and the belts retract easily.
 - ▶ If a belt does not retract easily, cleaning the belt may correct the problem. Only use a mild soap and warm water. Do not use bleach or cleaning solvents. Make sure the belt is completely dry before allowing it to retract.

Any belt that is not in good condition or working properly will not provide proper protection and should be replaced as soon as possible.

A belt that has been worn during a crash may not provide the same level of protection in a subsequent crash. Have your seat belts inspected by a dealer after any collision.

▶▶ Seat Belt Inspection

WARNING

Not checking or maintaining seat belts can result in serious injury or death if the seat belts do not work properly when needed.

Check your seat belts regularly and have any problem corrected as soon as possible.

WARNING: No modifications or additions should be made by the user which will either prevent the seat belt adjusting devices from operating to remove slack, or prevent the seat belt assembly from being adjusted to remove slack.

WARNING: It is essential to replace the entire assembly after it has been worn in a severe impact even if damage to the assembly is not obvious.

WARNING: Care should be taken to avoid contamination of the webbing with polishes, oils and chemicals, and particularly battery acid. Cleaning may safely be carried out using mild soap and water. The belt should be replaced if webbing becomes frayed, contaminated or damaged.

Anchorage Points



When replacing the seat belts, use the anchorage points shown in the images. The front seat has a lap/shoulder belt.

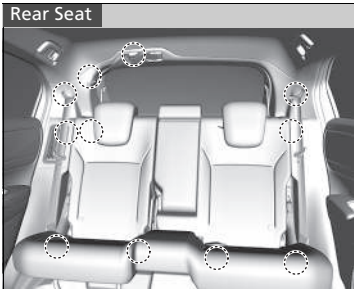

The rear seat has three lap/shoulder belts.

Airbag System Components

The front, side, and side curtain airbags are deployed according to the direction and severity of impact. The airbag system includes:

- Two SRS (Supplemental Restraint System) front airbags. The driver's airbag is stored in the centre of the steering wheel; the front passenger's airbag is stored in the dashboard. Both are marked **SRS AIRBAG**.
- Two side airbags, one for the driver and one for the front passenger. The airbags are stored in the outer edges of the seat-backs. Both are marked **SIDE AIRBAG**.
- Two side curtain airbags, one for each side of the vehicle. The airbags are stored in the ceiling, above the side windows. The front and rear pillars are marked **SIDE CURTAIN AIRBAG**.
- An electronic control unit that, when the power mode is in ON, continually monitors information about the various impact sensors, seat and buckle sensors, airbag activators, seat belt tensioners, and other vehicle information. During a crash event the unit can record such information.
- Automatic seat belt tensioners for the front seats and outer rear seats.
- Impact sensors that can detect a moderate-to-severe front or side impact.
- An indicator on the instrument panel that alerts you to a possible problem with your airbag system or seat belt tensioners.
- An indicator on the dashboard that alerts you that the passenger's front airbag has been turned off.
- Safing Sensor

■ Important Facts About Your Airbags

Airbags can pose serious hazards. To do their job, airbags must inflate with tremendous force. So, while airbags help to save lives, they can cause burns, bruises, and other minor injuries, sometimes even fatal ones if occupants are not wearing their seat belts properly and sitting correctly.

What you should do: Always wear your seat belt properly and sit upright and as far back from the steering wheel as possible while allowing full control of the vehicle. A front passenger should move their seat as far back from the dashboard as possible.

Remember, however, that no safety system can prevent all injuries or deaths that can occur in a severe crash, even when seat belts are properly worn and the airbags deploy.

Do not place hard or sharp objects between yourself and a front airbag.

Carrying hard or sharp objects on your lap, or driving with a pipe or other sharp object in your mouth, can result in injuries if your front airbag inflates.

Do not attach or place objects on the front airbag covers. Objects on the covers marked **SRS AIRBAG** could interfere with the proper operation of the airbags or be propelled inside the vehicle and hurt someone if the airbags inflate.

▣ Important Facts About Your Airbags

Do not attempt to deactivate your airbags. Together, airbags and seat belts provide the best protection.

When driving, keep hands and arms out of the deployment path of the front airbag by holding each side of the steering wheel. Do not cross an arm over the airbag cover.

Types of Airbags

Your vehicle is equipped with three types of airbags:

- **Front airbags:** Airbags in front of the driver's and front passenger's seats.
- **Side airbags:** Airbags in the driver's and front passenger's seat-backs.
- **Side curtain airbags:** Airbags above the side windows.

Each is discussed in the following pages.

Front Airbags (SRS)

The front SRS airbags inflate in a moderate-to-severe frontal collision to help to protect the head and chest of the driver and/or front passenger.

SRS (Supplemental Restraint System) indicates that the airbags are designed to supplement seat belts, not replace them. Seat belts are the occupant's primary restraint system.

■ Housing Locations

The front airbags are housed in the centre of the steering wheel for the driver, and in the dashboard for the front passenger. Both airbags are marked **SRS AIRBAG**.

✎ Types of Airbags

The airbags can inflate whenever the power mode is in ON.

After an airbag inflates in a crash, you may see a small amount of smoke. This is from the combustion process of the inflator material and is not harmful. People with respiratory problems may experience some temporary discomfort. If this occurs, get out of the vehicle as soon as it is safe to do so.

■ Operation

Front airbags are designed to inflate during moderate-to-severe frontal collisions. When the vehicle decelerates suddenly, the sensors send information to the control unit which signals one or both front airbags to inflate.

A frontal collision can be either head-on or angled between two vehicles, or when a vehicle crashes into a stationary object, such as a concrete wall.

■ How the Front Airbags Work

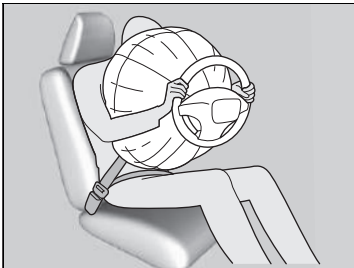

While your seat belt restrains your torso, the front airbag provides supplemental protection for your head and chest. The front airbags deflate immediately so that they won't interfere with the driver's visibility or the ability to steer or operate other controls.

The total time for inflation and deflation is so fast that most occupants are not aware that the airbags deployed until they see them lying in front of them.

■ When front airbags should not deploy

Minor frontal crashes: Front airbags were designed to supplement seat belts and help to save lives, not to prevent minor scrapes, or even broken bones that might occur during a less than moderate-to-severe frontal crash.

Side impacts: Front airbags can provide protection when a sudden deceleration causes a driver or front passenger to move towards the front of the vehicle. Side airbags and side curtain airbags have been specifically designed to help to reduce the severity of injuries that can occur during a moderate-to-severe side impact which can cause the driver or passenger to move towards the side of the vehicle.

Rear impacts: Head restraints and seat belts are your best protection during a rear impact. Front airbags cannot provide any significant protection and are not designed to deploy in such collisions.

Rollovers: Seat belts and side curtain airbags offer the best protection in a rollover. Because front airbags could provide little if any protection, they are not designed to deploy during a rollover.

■ When front airbags deploy with little or no visible damage

Because the airbag system senses sudden deceleration, a strong impact to the vehicle framework or suspension might cause one or more of the airbags to deploy. Examples include running into a curb, the edge of a hole, or other low fixed object that causes a sudden deceleration in the vehicle chassis. Since the impact is underneath the vehicle, damage may not be readily apparent.

■ When front airbags may not deploy, even though exterior damage appears severe

Since crushable body parts absorb crash energy during an impact, the amount of visible damage does not always indicate proper airbag operation. In fact, some collisions can result in severe damage but no airbag deployment because the airbags would not have been needed or would not have provided protection even if they had deployed.

■ Passenger Front Airbag Off System

If it is unavoidable to install a rear-facing child restraint system in the front passenger seat, you must manually deactivate the passenger front airbag system, using the built-in key.

■ Passenger front airbag ON/OFF switch

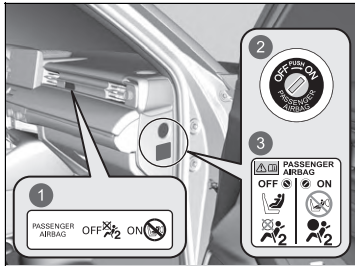

- 1 Passenger Front Airbag **ON/OFF** Indicator
- 2 **ON/OFF** Switch
- 3 System Warning Label

When the passenger front airbag **ON/OFF** switch is in:

OFF: The passenger front airbag is deactivated. The passenger front airbag does not inflate during a frontal crash that inflates driver's front airbag.

The passenger front airbag off indicator stays on as a reminder.

ON: The passenger front airbag is activated.

The passenger front airbag on indicator comes on and remains on for about 60 seconds.

▶▶ Passenger Front Airbag Off System

⚠ **WARNING**

The passenger front airbag system must be turned off, if it is not avoidable to put a rear-facing child restraint system in the front passenger seat.

If the front passenger airbag inflates, it can hit the rear-facing child restraint system with enough force to kill or cause a very serious injury to the infant.

⚠ **WARNING**

Make sure to turn on the passenger front airbag system when a rear-facing child restraint system is not used on the front passenger seat.

Leaving the passenger front airbag system deactivated can result in serious injury or death in a crash.

■ To deactivate the passenger front airbag system

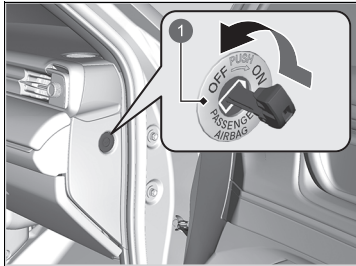

① Passenger Front Airbag **ON/OFF** Switch

1. Set the parking brake, and set the power mode to **VEHICLE OFF**.
2. Open the front passenger's door.
3. Insert the built-in key to the passenger front airbag **ON/OFF** switch.
 - ▶ The switch is located at the side panel of the front passenger side instrument panel.
4. Turn the built-in key to **OFF**, and remove it from the switch.

■ Passenger front airbag off indicator

When the passenger front airbag system is activated, the indicator goes off after a few seconds when you set the power mode to **ON**.

When the passenger front airbag system is deactivated, the indicator stays on, or goes off momentarily and comes back on.

▶▶ To deactivate the passenger front airbag system

NOTICE

- Use your vehicle's built-in key to turn the passenger front airbag **ON/OFF** switch. If you use a different key, the switch can be damaged, or the passenger front airbag system may not work properly.
- Do not close the door or apply an excessive load on the built-in key while the key is in the passenger front airbag **ON/OFF** switch. The switch or the key can be damaged.

We strongly recommend that you do not install a rear-facing child restraint system in the front passenger seat.

▶ **Protecting Infants** P. 76

It is your responsibility to change the setting of the passenger front airbag system to **OFF** when you put a rear-facing child restraint system on the front passenger seat.

When a rear-facing child restraint system is not in use in the front passenger seat, turn the system back on.

■ Passenger front airbag off system label

The label is located at the side panel of the front passenger side instrument panel.



- ① Infant in a rear-facing child restraint system: May ride in front if it is unavoidable
- ② Cannot be seated in front
- ③ Passenger front airbag is: Active
- ④ Inactive

Side Airbags

The side airbags help to protect the torso and pelvis of the driver or a front passenger during a moderate-to-severe side impact.

Housing Locations

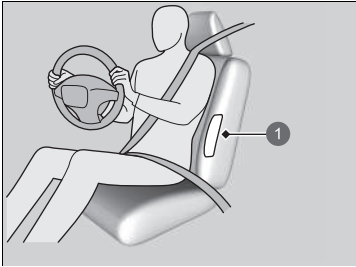

① Side Airbag Location

The side airbags are housed in the outside edge of the driver's and passenger's seat-backs.

Both are marked **SIDE AIRBAG**.

Side Airbags

Do not attach accessories on or near the side airbags. They can interfere with the proper operation of the airbags, or hurt someone if an airbag inflates.

■ Operation

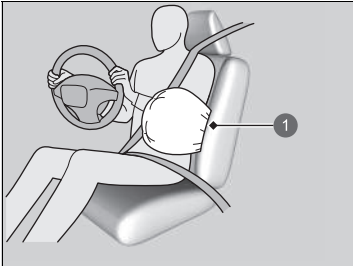

① Deployed Side Airbag

When the sensors detect a moderate-to-severe side impact, the control unit signals the side airbag on the impact side to immediately inflate.

■ When a side airbag deploys with little or no visible damage

Because the airbag system senses sudden acceleration, a strong impact to the side of the vehicle's framework can cause a side airbag to deploy. In such cases, there may be little or no damage, but the side impact sensors detected a severe enough impact to deploy the airbag.

■ When a side airbag may not deploy, even though visible damage appears severe

It is possible for a side airbag not to deploy during an impact that results in apparently severe damage. This can occur when the point of impact was towards the far front or rear of the vehicle, or when the vehicle's crushable body parts absorbed most of the crash energy. In either case, the side airbag would not have been needed nor provided protection even if it had deployed.

⊠ Side Airbags

Do not cover or replace the front seat-back covers without consulting a dealer. Improperly replacing or covering front seat-back covers can prevent your side airbags from properly deploying during a side impact.

Do not let the front passenger lean sideways with their head in the deployment path of the side airbag. An inflating side airbag can strike with strong force and seriously injure the passenger.

Side Curtain Airbags

The side curtain airbags help to protect the heads of the driver and passengers in outer seating positions during a moderate-to-severe side impact.

Housing Locations

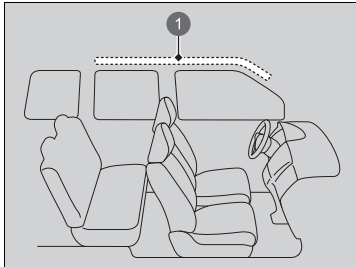

① Side Curtain Airbag Location

The side curtain airbags are located in the ceiling above the side windows on both sides of the vehicle.

Side Curtain Airbags

The side curtain airbags are most effective when an occupant is wearing their seat belt properly and sitting upright, well back in their seat.

Do not attach any objects to the side windows or roof pillars as they can interfere with the proper operation of the side curtain airbags.

Do not put a coat hanger or hard objects on a coat hook. This could result in injuries if your side curtain airbag inflates.

■ Operation

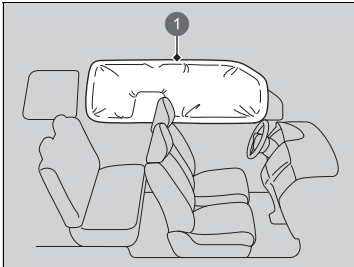

The side curtain airbag is designed to deploy in a moderate-to-severe side impact.

① Deployed Side Curtain Airbag

■ When side curtain airbags deploy in a frontal collision

One or both side curtain airbags may also inflate in a moderate-to-severe angled frontal collision.

Airbag System Indicators

If a problem occurs in the airbag system, the SRS indicator will come on and a message appears on the driver information interface.

■ Supplemental Restraint System (SRS) Indicator

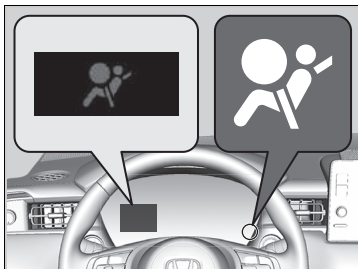

■ When the power mode is set to ON

The indicator comes on for a few seconds, then goes off. This tells you the system is working properly.

If the indicator comes on at any other time, or does not come on at all, have the system checked by a dealer as soon as possible. If you don't, your airbags and seat belt tensioners may not work properly when they are needed.

ⓘ Supplemental Restraint System (SRS) Indicator

⚠ WARNING

Ignoring the SRS indicator can result in serious injury or death if the airbag systems or tensioners do not work properly.

Have your vehicle checked by a dealer as soon as possible if the SRS indicator alerts you to a possible problem.

⚠ WARNING

Remove the rear-facing child restraint system immediately from the front passenger seat if the SRS indicator comes on. Even if the passenger front airbag has been deactivated, do not ignore the SRS indicator.

The SRS system may have a fault which could cause the passenger front airbag to be activated, causing serious injury or death.

■ Passenger Front Airbag Off Indicator

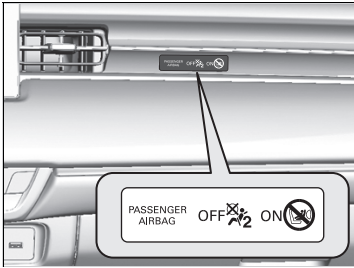

■ When the passenger airbag off indicator comes on

The indicator stays on while the passenger's front airbag system is deactivated.

When a rear-facing child restraint system is not in use in the front passenger seat, manually turn the system back on. The indicator should go off.

Airbag Care

You do not need to, and should not, perform any maintenance on or replace any airbag system components yourself. However, you should have your vehicle inspected by a dealer in the following situations:

■ When the airbags have deployed

If an airbag has inflated, the control unit and other related parts must be replaced. Similarly, once an automatic seat belt tensioner has been activated, it must be replaced.

■ When the vehicle has been in a moderate-to-severe collision

Even if the airbags did not inflate, have your dealer inspect the following: the seat belt tensioners for the front seats and outer rear seats, and each seat belt that was worn during the crash.

✎ Airbag Care

The removal of airbag components from the vehicle is prohibited.

In case of malfunction, or shutdown, or after the airbag inflation/seat belt tensioner operation, ask a qualified personnel for handling.

We recommend against the use of salvaged airbag system components, including the airbag, tensioners, sensors, and control unit.

Protecting Child Passengers

Each year, many children are injured or killed in vehicle crashes because they are either unrestrained or not properly restrained. In fact, vehicle crashes are the number one cause of death of children aged 12 and under.

To reduce the number of child deaths and injuries, infants and children should be properly restrained when they ride in a vehicle.

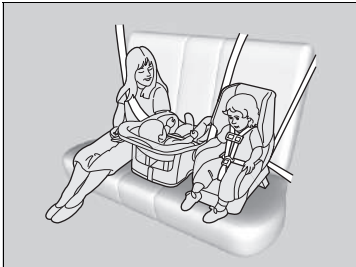

Children should sit properly restrained in a rear seat. This is because:

- An inflating front airbag can injure or kill a child sitting in the front seat.
- A child in the front seat is more likely to interfere with the driver's ability to safely control the vehicle.
- Statistics show that children of all sizes and ages are safer when they are properly restrained in a rear seat.

Protecting Child Passengers

Front Passenger's Sun Visor

⚠ WARNING



NEVER use a rearward facing child restraint on a seat protected by an **ACTIVE AIRBAG** in front of it, **DEATH** or **SERIOUS INJURY** to the **CHILD** can occur.

⚠ WARNING

Children who are unrestrained or improperly restrained can be seriously injured or killed in a crash.

Any child too small for a seat belt should be properly restrained in an approved child restraint system. A larger child should be properly restrained with a seat belt, using a booster seat if necessary.

- Never hold a child on your lap because it is impossible to protect them in the event of a collision.
- Never put a seat belt over yourself and a child. During a crash, the belt would likely press deep into the child and cause serious or fatal injuries.
- Never let two children use the same seat belt. Both children could be very seriously injured in a crash.
- Any child who is too small to wear a seat belt must be properly restrained in an approved child restraint system that is properly secured to the vehicle using the seat belt or the child restraint anchorage system.

► Protecting Child Passengers

In many countries, the law requires all children aged 12 and under, and whose height are shorter than 150 cm (60 inches) be properly restrained in a rear seat.

In many countries, it is required to use an officially approved and suitable child restraint system for transporting a child on any passenger seat. Check your local legal requirement.

We recommend a child restraint system compliant with UN Regulation No. 44 or No. 129, or the regulations of the subject countries.

► **Selecting a Child Restraint System** P. 79

- Do not allow children to operate the doors, windows, or seat adjustments.
- Do not leave children in the vehicle unattended, especially in hot weather when the inside of the vehicle can get hot enough to kill them. They could also activate vehicle controls causing it to move unexpectedly.

▶▶ Protecting Child Passengers

WARNING: Use the power window lock button to prevent children from opening the windows. Using this feature will prevent children from playing with the windows, which could expose them to hazards or distract the driver.

▶ Opening/Closing the Power Windows

P. 177

WARNING: Always take the ignition key with you whenever you leave the vehicle alone or with other occupants.

To remind you of the passenger's front airbag hazard and child safety, your vehicle has the warning label on the passenger's side sun visor.

Please read and follow the instructions on this label.

▶ Safety Labels P. 99

Safety of Infants and Small Children

■ Protecting Infants

An infant must be properly restrained in a rear-facing child restraint system until the infant reaches the child restraint system manufacturer's weight or height limit for the seat.



■ Positioning a rear-facing child restraint system

Child restraint system must be placed and secured in a rear seating position.

- We recommend that you install the child restraint system directly behind the front passenger's seat, move the seat as far forward as needed, and leave it unoccupied.
- Make sure that there is no contact between the child restraint system and the seat in front of it.
If there is, you may wish to get a smaller rear-facing child restraint system.

► Protecting Infants

⚠ WARNING

Placing a rear-facing child restraint system in the front seat can result in serious injury or death if the passenger's front airbag inflates.

Always place a rear-facing child restraint system in the back seat, not the front.

When properly installed, a rear-facing child restraint system may prevent the driver or a front passenger from moving their seat all the way back, or from locking their seat-back in the desired position.

▣ Protecting Infants

Many experts recommend use of a rear-facing child restraint system for a child up to two years old if the child's height and weight are appropriate for a rear-facing child restraint system.

Rear-facing child restraint systems should never be installed in a front-facing position.

Always refer to the child restraint system manufacturer's instructions before installation.

If the passenger's front airbag inflates, it can hit the rear-facing child restraint system with great force, which can dislodge or strike the system, and seriously injure the child.

If it is absolutely unavoidable to install a rear-facing child restraint system in the front passenger seat, manually turn off the passenger front airbag system.

➤ **Passenger Front Airbag Off System** P. 63

■ Protecting Smaller Children

If a child has exceeded the weight and height limitations of a rear-facing child restraint system, the child should be properly restrained in a firmly secured front-facing child restraint system until they exceed the weight and height limitations for the front-facing child restraint system.



■ Front-facing child restraint system placement

We strongly recommend placing a front-facing child restraint system in a rear seating position.

Placing a front-facing child restraint system in the front seat can be hazardous. A rear seat is the safest place for a child.

▶▶ Protecting Smaller Children

⚠️ WARNING

Placing a front-facing child restraint system in the front seat can result in serious injury or death if the front airbag inflates.

If you must place a front-facing child restraint system in front, move the vehicle seat as far back as possible, and properly restrain the child.

Educate yourself about the laws and regulations regarding child restraint system use where you are driving, and follow the child restraint system manufacturer's instructions.

■ Selecting a Child Restraint System

Some child restraint systems are lower anchorage compatible. Some have a rigid-type connector while others have a flexible-type connector. Both are equally easy to use. Some existing and previously owned child restraint systems can only be installed using the seat belt. Whichever type you choose, follow the child restraint system manufacturer's use and care instructions including recommended expiration dates as well as the instructions in this manual. Proper installation is key to maximising your child's safety.

The flexible type may not be available in your country.

In seating positions and vehicles not equipped with lower anchorages, install a child restraint system using the seat belt and a top tether for added security. This is because all child restraint systems must be secured with the seat belt when the lower anchorage system is not in use. In addition, the child restraint system manufacturer may advise that a seat belt be used to attach an ISOFIX restraint system once a child reaches a specified weight. Please read the child restraint system owner's manual for proper installation instructions.

■ Important consideration when selecting a child restraint system

Make sure the child restraint system meets the following three requirements:

- The child restraint system is the correct type and size for the child.
- The child restraint system is the correct type for the seating position.
- The child restraint system is compliant with safety standards. We recommend a child restraint system compliant with UN Regulation No. 44 or No. 129, or the regulations of the subject countries. Look for the approval mark on the system and the manufacturer's statement of compliance on the box.

▶▶ Selecting a Child Restraint System

Installation of a lower anchorage-compatible child restraint system is simple.

Lower anchorage-compatible child restraint systems have been developed to simplify the installation process and reduce the likelihood of injuries caused by incorrect installation.

Continued

■ Child Restraint Systems Standards

If a child restraint system (whether an i-Size/ISOFIX type or one that is fitted with a seat belt) meets the relevant UN Regulation, it will be affixed with an approval label as shown in the adjacent table. Before purchasing or using any child restraint system, make sure to check the approval label and ensure that it is compatible with your vehicle and the child, and that it complies with the relevant UN Regulation.

► Selecting a Child Restraint System

Example of UN Regulation No. 44 approval label

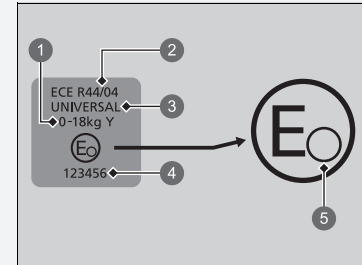

- ① “Mass group”
- ② Regulation number
- ③ Category
- ④ Approval number
- ⑤ Country code

▶▶ Selecting a Child Restraint System

Example of UN Regulation No. 129 approval label

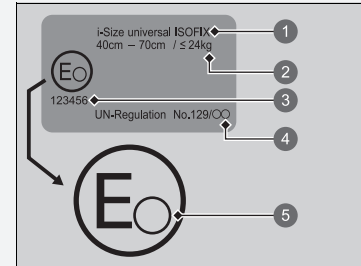

- ① Category
- ② Size and weight indication
- ③ Approval number
- ④ Regulation number
- ⑤ Country code

Continued

Locations for Child Restraint System Installation

Left-hand drive type
 Passenger Airbag ON or without
 Passenger Airbag ON/OFF SW



Passenger Airbag OFF



	Suitable for universal restraint systems installed with vehicle safety belts.
	Suitable for forward facing universal restraint systems installed with vehicle safety belts.
	Suitable for i-Size and ISOFIX child restraints systems.
	Suitable for forward facing restraint systems only.
	Never use a rearward facing child restraint system.
	Seat position equipped with Top Tether anchorages.

- *1: Forward facing only.
- *2:
 - Adjust the seat slide to the rearmost position.
 - If the child restraint system interferes with the head restraint and cannot be installed stably, raise the head restraint to the highest position. If this interference is unavoidable even after raising, remove the head restraint. Please note that the removed head restraint should be stored in the luggage compartment so that it will not fly during sudden braking or collision. Also, if you remove the child restraint system, attach the head restraint to the original seat and make sure it is locked.
- *3: For installing the universal belted type, adjust the seat back to the most front lock position.
- *4: If the child restraint system interferes with the head restraint and cannot be installed stably, raise it to the top.
- *5: If you attach a child restraint system to the rear centre seat, the seat belt on one side cannot be used.
- *6: If you attach a child restraint system to the rear left seat, the centre seat belt cannot be used.
- *7: Attaching a child restraint system to the rear right seat may make the centre seat belt unusable.
- *8: If attaching an ISOFIX child restraint system to the rear left seat, the centre seat belt cannot be used.

Child restraint systems with support legs can be installed on non i-Size seating positions. However, the centre seat is excluded.

Right-hand drive type

Passenger Airbag ON or without
Passenger Airbag ON/OFF SW



Passenger Airbag OFF



	Suitable for universal restraint systems installed with vehicle safety belts.
	Suitable for forward facing universal restraint systems installed with vehicle safety belts.
	Suitable for i-Size and ISOFIX child restraints systems.
	Suitable for forward facing restraint systems only.
	Never use a rearward facing child restraint system.
	Seat position equipped with Top Tether anchorages.

- *1: Forward facing only.
- *2:
 - Adjust the seat slide to the rearmost position.
 - If the child restraint system interferes with the head restraint and cannot be installed stably, raise the head restraint to the highest position. If this interference is unavoidable even after raising, remove the head restraint. Please note that the removed head restraint should be stored in the luggage compartment so that it will not fly during sudden braking or collision.
- Also, if you remove the child restraint system, attach the head restraint to the original seat and make sure it is locked.
- *3: For installing the universal belted type, adjust the seat back to the most front lock position.
- *4: If the child restraint system interferes with the head restraint and cannot be installed stably, raise it to the top.
- *5: If you attach a child restraint system to the rear centre seat, the seat belt on one side cannot be used.
- *6: If you attach a child restraint system to the rear left seat, the centre seat belt cannot be used.
- *7: Attaching a child restraint system to the rear right seat may make the centre seat belt unusable.
- *8: If attaching an ISOFIX child restraint system to the rear left seat, the centre seat belt cannot be used.

Child restraint systems with support legs can be installed on non i-Size seating positions. However, the centre seat is excluded.

All models

Detail information for CRS installation

	Seating position and Seat position number						
	Size groups Weight Stature		①		②	③	④
			Front passenger*2		2nd row*4		
			Front passenger airbag ON/OFF switch position		Left *6*8	Centre *5	Right *7
		ON*1	OFF				
Seating position suitable for universal belted (yes/no)	Group 0	Up to 10kg	No		Yes	Yes	Yes
	Group 0+	Up to 13kg					
	Group I	9-18kg	Yes*3		Yes	Yes	Yes
	Group II	15-25kg					
	Group III	22-36kg					
i-Size seating position (yes/no)	≤ 150cm		No	No	Yes	No	Yes
Seating position suitable for recommended genuine CRS*9	Refer to genuine CRS list		Yes	Yes	Yes	Yes	Yes
Seating position suitable for lateral fixture (L1/L2)	—		No	No	No	No	No
Largest suitable rearward facing fixture (R1/R2X/R2/R3)	Group 0	Up to 10kg	No	No	R3	No	R3
	Group 0+	Up to 13kg					
	Group I	9-18kg					
Largest suitable forward facing fixture (F2X/F2/F3)	Group I	9-18kg	No	No	F3	No	F3
Largest suitable booster fixture (B2/B3)	≤ 150cm		B3*3	B3*3	B3	B3	B3

▶ Locations for Child Restraint System Installation

When purchasing a child restraint systems, make sure to check the ISOFIX size class or the fixture to ensure that the seat is compatible with your vehicle.

Fixture (CRF)	Description
ISO/L1	Left lateral-facing (carrycot) infant seat
ISO/L2	Right lateral-facing (carrycot) infant seat
ISO/R1	Rearward-facing infant seat
ISO/R2X	Reduced-size rearward-facing child restraint systems
ISO/R2	Reduced-size rearward-facing child restraint systems
ISO/R3	Full-size rearward-facing child restraint systems
ISO/F2X	Reduced-height forward-facing child restraint systems
ISO/F2	Reduced-height forward-facing child restraint systems
ISO/F3	Full-height, forward-facing child restraint systems
ISO/B2	Reduced width forward-facing booster seat
ISO/B3	Full width forward-facing booster seat

- *1: Forward facing only.
- *2:
 - Adjust the seat slide to the rearmost position.
 - If the child restraint system interferes with the head restraint and cannot be installed stably, raise the head restraint to the highest position. If this interference is unavoidable even after raising, remove the head restraint. Please note that the removed head restraint should be stored in the luggage compartment so that it will not fly during sudden braking or collision.
 - Also, if you remove the child restraint system, attach the head restraint to the original seat and make sure it is locked.
- *3: For installing the universal belted type, adjust the seat back to the most front lock position.
- *4: If the child restraint system interferes with the head restraint and cannot be installed stably, raise it to the top.
- *5: If you attach a child restraint system to the rear centre seat, the left seat belt cannot be used.
- *6: If you attach a child restraint system to the rear left seat, the centre seat belt cannot be used.
- *7: Attaching a child restraint system to the rear right seat may make the centre seat belt unusable.
- *8: If attaching an ISOFIX child restraint system to the rear left seat, the centre seat belt cannot be used.
- *9: The named Child Restraint Systems (CRS) reflect Honda's recommendations at the date of publication. You should speak to an authorised dealer for up to date details relating to our recommended CRSs.
Other CRS may also be suitable - please consult CRS manufacturers for recommended vehicle lists.

Child restraint systems with support legs can be installed on non i-Size seating positions. However, the centre seat is excluded.

■ Europe Genuine CRS List

UN R129

Range of application	Child Restraint System	Category
40cm to 83cm up to 13kg (Birth - 15 months)	Honda baby safe	Universal Belted
	Honda baby safe ISOFIX	i-Size universal ISOFIX
76cm to 105cm 9kg to 22kg (15 months - 4 years)	Honda ISOFIX	i-Size Universal ISOFIX
100cm to 150cm 15kg to 36kg (3.5 years - 12 years)	Honda KIDFIX	i-Size Booster seat

■ Installing a Lower Anchorage-Compatible Child Restraint System

A lower anchorage-compatible child restraint system can be installed in either of the two outer rear seats. A child restraint system is attached to the lower anchorages with either the rigid or flexible type of connectors (see illustrations).



1 Marks

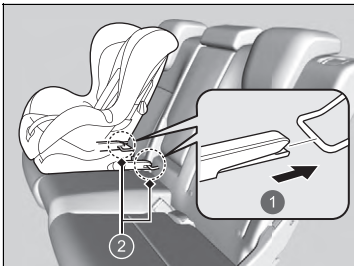

- 1 Rigid Type
- 2 Lower Anchorages

1. Locate the lower anchorages under the marks.

2. Place the child restraint system on the vehicle seat, then attach the child restraint system to the lower anchorages according to the instructions that came with the child restraint system.

▶ When installing the child restraint system, make sure that the lower anchorages are not obstructed by the seat belt or any other object.

⊠ Installing a Lower Anchorage-Compatible Child Restraint System

⚠ WARNING

Never attach two child restraint systems to the same anchorage. In a collision, one anchorage may not be strong enough to hold two child restraint system attachments and may break, causing serious injury or death.

Some child restraint systems come with optional guide-cups, which avoid possible damage to the seat surface. Follow the manufacturer's instructions when using the guide-cups, and attach them to the lower anchorages as shown in the image.

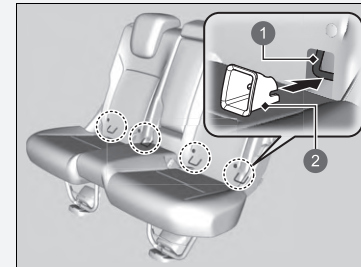

- 1 Lower Anchorage
- 2 Guide-cup

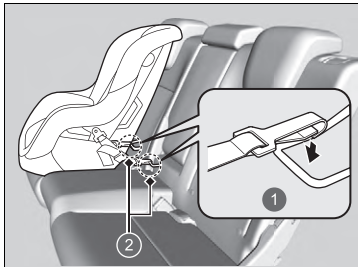

- 1 Flexible Type
- 2 Lower Anchorages

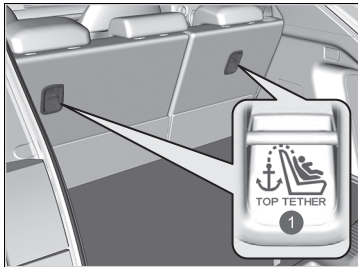

- 1 Top Tether Anchorage Symbol

► Installing a Lower Anchorage-Compatible Child Restraint System

WARNING: Never use a hook that does not come with a Top Tether Anchorage Symbol when securing an installed child restraint system.

For your child's safety, when using a child restraint system installed using the lower anchorage system, make sure that the child restraint system is properly secured to the vehicle.

A child restraint system that is not properly secured will not adequately protect a child in a crash and may cause injury to the child or other vehicle occupants.

The flexible type may not be available in your country.

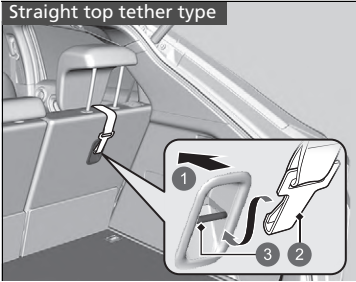

- ① Ahead of the Vehicle
- ② Tether Strap Hook
- ③ Anchorage

Child restraint system with tether strap

3. Raise the head restraint to its highest position.
 - ▶ Remove the luggage area cover.
 - **Luggage Area Cover** P. 227
4. Route the tether strap between the head restraint legs.
5. Secure the tether strap hook to the anchorage.
6. Tighten the tether strap as instructed by the child restraint system manufacturer.
7. Make sure the child restraint system is firmly secured by rocking it forward and back, and side to side; little movement should be felt.
8. Make sure any unused seat belt that a child can reach is buckled.

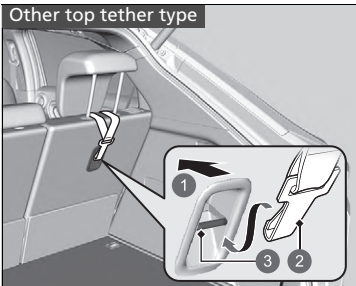

- ① Ahead of the Vehicle
- ② Tether Strap Hook
- ③ Anchorage

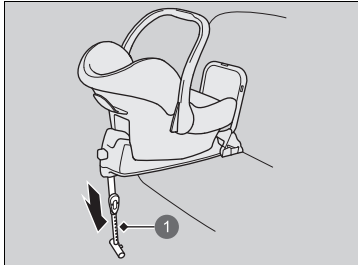

1 Support Leg

Child restraint system with support leg

3. Extend the support leg until it touches the floor as instructed by the child restraint system manufacturer.
 - ▶ Confirm that the section of the floor on which the support leg rests is level. If the section is not level, the support leg will not provide adequate support.
 - ▶ Make sure that there is no contact between the child restraint system and the seat in front of it.

■ Installing a Child Restraint System with a Lap/Shoulder Seat Belt

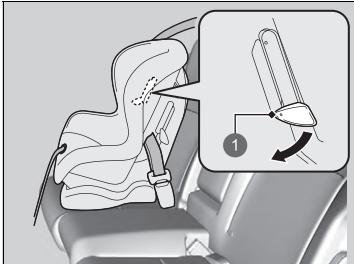
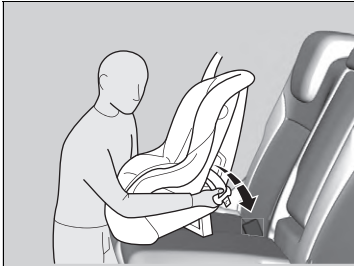

1 Tab

1. Place the child restraint system on the vehicle seat.
2. Route the seat belt through the child restraint system according to the child restraint system manufacturer's instructions, and insert the latch plate into the buckle.
 - ▶ Insert the latch plate fully until it clicks.
3. Push down the tab. Route the shoulder part of the belt into the slit at the side of the restraint.
4. Grab the shoulder part of the belt near the buckle, and pull up to remove any slack from the lap part of the belt.
 - ▶ When doing this, place your weight on the child restraint system and push it into the vehicle seat.
5. Position the belt properly and push up the tab. Make sure the belt is not twisted.
 - ▶ When pushing up the tab, pull up the upper shoulder part of the belt to remove any slack from the belt.

⚠ Installing a Child Restraint System with a Lap/Shoulder Seat Belt

A child restraint system that is not properly secured will not adequately protect a child in a crash and may cause injury to the child or other vehicle occupants.

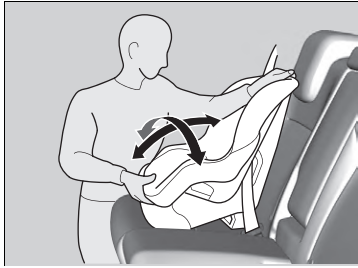

6. Make sure the child restraint system is firmly secured by rocking it forward and back, and side to side; little movement should be felt.
7. Make sure any unused seat belt that a child can reach is buckled.

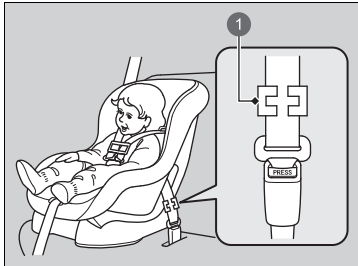

1 Locking Clip

Except European models

If your child restraint system does not come with a mechanism that secures the belt, install a locking clip on the seat belt.

After going through the step 1 and 2, pull up the shoulder part of the belt and make sure there is no slack in the lap portion.

3. Tightly grasp the belt near the latch plate. Pinch both parts of the belt together so they do not slip through the latch plate. Unbuckle the seat belt.
4. Install the locking clip as shown in the image. Position the clip as close as possible to the latch plate.
5. Insert the latch plate into the buckle. Go to step 6 and 7.

■ Adding Security with a Tether

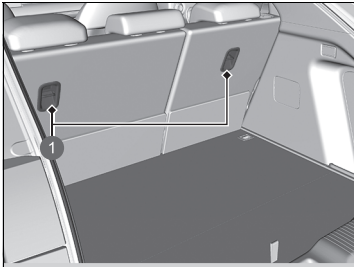

1 Tether Anchorage Points

A tether anchorage point is provided behind each rear outer seating position. If you have a child restraint system that comes with a tether but can be installed with a seat belt, the tether may be used for additional security.

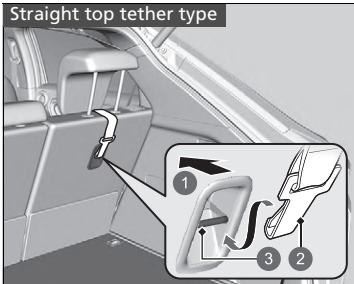

- 1 Ahead of the Vehicle
- 2 Tether Strap Hook
- 3 Anchorage

1. Raise the head restraint to its highest position.
 - ▶ Remove the luggage area cover.
 - **Luggage Area Cover** P. 227
2. Route the tether strap between the head restraint legs.
3. Secure the tether strap hook to the anchorage.
4. Tighten the tether strap as instructed by the child restraint system manufacturer.
5. Make sure the child restraint system is firmly secured by rocking it forward and back, and side to side; little movement should be felt.
6. Make sure any unused seat belt that a child can reach is buckled.

▣ Adding Security with a Tether

WARNING: Child restraint anchorages are designed to withstand only those loads imposed by correctly fitted child restraints. Under no circumstances are they to be used for adult seat belts, harnesses or for attaching other items or equipment to the vehicle.

Always use a tether for front-facing child restraint system whether using the seat belt or lower anchorages.

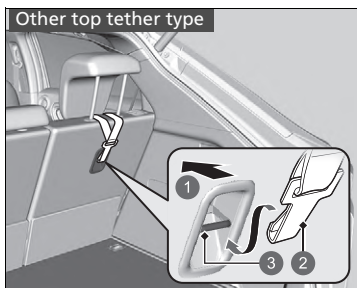

- ① Ahead of the Vehicle
- ② Tether Strap Hook
- ③ Anchorage

Safety of Larger Children

■ Protecting Larger Children

The following pages give instructions on how to check proper seat belt fit, what kind of booster seat to use if one is needed, and important precautions for a child who must sit in front.

■ Checking Seat Belt Fit

When a child is too big for a child restraint system, secure the child in a rear seat using the lap/shoulder seat belt. Have the child sit upright and all the way back, then answer the following questions.



■ Checklist

- Do the child's knees bend comfortably over the edge of the seat?
- Does the shoulder belt cross between the child's neck and arm?
- Is the lap part of the seat belt as low as possible, touching the child's thighs?
- Will the child be able to stay seated like this for the whole trip?

If you answer yes to all these questions, the child is ready to wear the lap/shoulder seat belt correctly. If you answer no to any question, the child needs to ride on a booster seat until the seat belt fits properly without a booster seat.

▶▶ Safety of Larger Children

⚠ WARNING

Allowing a child aged 12 or under to sit in front can result in injury or death if the passenger's front airbag inflates.

If a larger child must ride in front, move the vehicle seat as far to the rear as possible, have the child sit up properly and wear the seat belt properly, using a booster seat if needed.

Booster Seats



If a lap/shoulder seat belt cannot be used properly, position the child in a booster seat in the rear seat. For the child's safety, check that the child meets the booster seat manufacturer's recommendations.

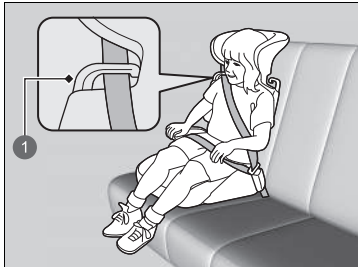

1 Guide

A backrest is available for a specific booster seat. Install the backrest to the booster seat and adjust it to the vehicle seat according to the booster seat manufacturer's instructions. Make sure the seat belt is properly routed through the guide at the shoulder of the backrest and the belt does not touch and cross the child's neck.

Booster Seats

When installing a booster seat, make sure to read the instructions that came with it, and install the seat accordingly.

There are high- and low-type booster seats. Choose a booster seat that allows the child to wear the seat belt correctly.

We recommend a booster seat with a backrest as it is easier to adjust the shoulder belt.

■ Protecting Larger Children - Final Checks

Your vehicle has a rear seat where children can be properly restrained. If you ever have to carry a group of children, and a child must ride in front:

- Make sure you read and fully understand the instructions and safety information in this manual.
- Move the front passenger seat as far back as possible.
- Have the child sit upright and well back in the seat.
- Check that the seat belt is properly positioned so that the child is secure in the seat.

■ Monitoring child passengers

We strongly recommend that you keep an eye on child passengers. Even older, more mature children sometimes need to be reminded to fasten their seat belts and sit up properly.

Carbon Monoxide Gas

The engine exhaust from this vehicle contains carbon monoxide, a colourless, odourless, and highly toxic gas. As long as you properly maintain your vehicle, carbon monoxide gas will not get into the interior.

■ Have the exhaust system inspected for leaks whenever

- The exhaust system is making an unusual noise.
- The exhaust system may have been damaged.
- The vehicle is raised for an oil change.

When you operate a vehicle with the tailgate open, airflow can pull exhaust gas into the interior and create a hazardous condition. If you must drive with the tailgate open, open all the windows and set the climate control system as shown below.

1. Select the fresh air mode.
2. Select the  mode.
3. Set the fan speed to high.
4. Set the temperature control to a comfortable setting.

Adjust the climate control system in the same manner if you sit in your parked vehicle with the engine running.

ⓘ Carbon Monoxide Gas

WARNING

Carbon monoxide gas is toxic. Breathing it can cause unconsciousness and even kill you.

Avoid any enclosed areas or activities that expose you to carbon monoxide.

An enclosed area such as a garage can quickly fill up with carbon monoxide gas.

Do not run the engine with the garage door closed. Even when the garage door is open, drive out of the garage immediately after starting the engine.

Label Locations

These labels are in the locations shown. They warn you of potential hazards that can cause serious injury or death. Read these labels carefully.

If a label comes off or becomes hard to read, contact a dealer for a replacement.

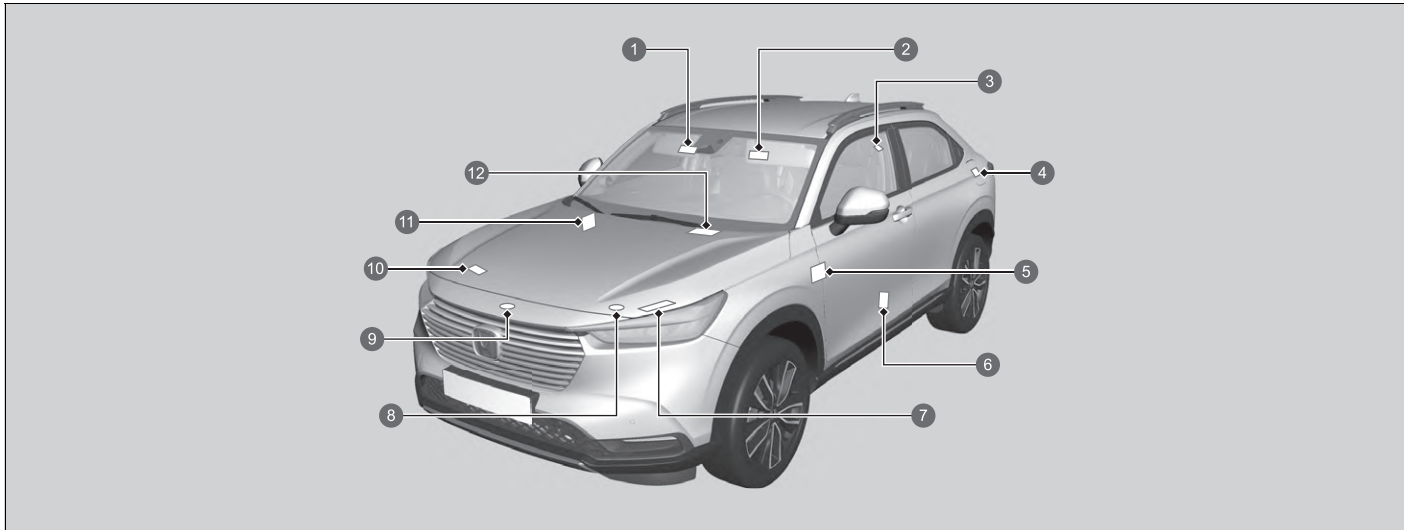

- ① Protecting Child Passenger (Left-hand drive type) ➤ P. 73
- ② Protecting Child Passenger (Right-hand drive type) ➤ P. 73
- ③ Rear Head Restraint ➤ P. 216
- ④ Fuel ➤ P. 495
- ⑤ Passenger Front Airbag Off System (Right-hand drive type) ➤ P. 65
- ⑥ Information for Painting ➤ P. 563
- ⑦ 12-volt battery ➤ P. 551

- 8 Inverter Coolant Reserve Tank Cap
- 9 Radiator Cap ➤ P. 526
- 10 Air Conditioner ➤ P. 554
- 11 Passenger Front Airbag Off System (Left-hand drive type) ➤ P. 65
- 12 Wireless Charger* ➤ P. 233

Instrument Panel

This chapter describes the buttons, indicators, and gauges that are used while driving.



















Indicators	102
Driver Information Interface Warning and Information Messages.....	120
Gauges and Driver Information Interface	
Gauges.....	132
Driver Information Interface	135

Indicators come on/blink depending on the condition of the vehicle. Messages may display on the driver information interface at the same time. Please take the appropriate action outlined in the message, such as contacting a dealer.



























Display messages by setting **Warning Message** to ON.

You can also change the message language.

📄 **Customized Features** P. 304

 *1	Parking Brake and Brake System Indicator (Red)	→P. 104	 *1	12-Volt Battery Charging System Indicator	→P. 107	 *1	EV Indicator	→P. 107
 *1	Parking Brake and Brake System Indicator (Amber)	→P. 106		Shift Position Indicator	→P. 108		Seat Belt Reminder Indicator	→P. 109
 *1	Automatic Brake Hold System Indicator	→P. 106		Deceleration Paddle Selector Indicator	→P. 108		Low Fuel Indicator	→P. 109
 *1	Automatic Brake Hold Indicator	→P. 106		Transmission System Indicator	→P. 108	 *1	Anti-lock Brake System (ABS) Indicator	→P. 109
 *1	Malfunction Indicator Lamp	→P. 107	 *1	Power System Indicator	→P. 107	 *1	Supplemental Restraint System Indicator	→P. 109
			 *1	Ready Indicator	→P. 107	 *1	Passenger Front Airbag On/Off Indicators	→P. 110



*1 : When you set the power mode to ON, these indicators come on to indicate that system checks are being performed. They go off a few seconds later or after the power system has started. If an indicator does not come on or turn off, there may be a malfunction in the corresponding system. To resolve the issue, follow the instructions in the owner's manual.





 *1 Vehicle Stability Assist (VSA) System Indicator →P. 110	 *1 Auto High-Beam Indicator →P. 113	 Security System Alarm Indicator →P. 113
 *1 Vehicle Stability Assist (VSA) OFF Indicator →P. 110	 ECON ECON Mode Indicator →P. 114	 Immobilizer System Indicator →P. 113
 *1 Electric Power Steering (EPS) System Indicator →P. 111	 SPORT SPORT Mode Indicator →P. 114	 *1 Adaptive Cruise Control (ACC) with Low Speed Follow Indicator (Amber) →P. 116
 *1 Low Tyre Pressure/Deflation Warning System Indicator →P. 112	 NORMAL NORMAL Mode Indicator →P. 114	 Adaptive Cruise Control (ACC) with Low Speed Follow Indicator (White/Green) →P. 116
 Turn Signal and Hazard Warning Indicators →P. 111	 System Message Indicator →P. 114	 *1 Lane Keeping Assist System (LKAS) Indicator (Amber) →P. 116
 High Beam Indicator →P. 111	 Road Departure Mitigation Ready to Assist Indicator →P. 117	 Lane Keeping Assist System (LKAS) Indicator (White/Green) →P. 117
 Lights On Indicator →P. 111	 LIM Adjustable Speed Limiter Indicator (White/Green) →P. 115	 *1 Safety Support Indicator (Amber) →P. 117
 Front Fog Light Indicator* →P. 111	 LIM Intelligent Speed Limiter Indicator (White/Green) →P. 115	 Safety Support Indicator (Green/Grey) →P. 119
 Rear Fog Light Indicator →P. 112	 Hill Descent Control System Indicator (White/Green) →P. 115	



*1: When you set the power mode to ON, these indicators come on to indicate that system checks are being performed. They go off a few seconds later or after the power system has started. If an indicator does not come on or turn off, there may be a malfunction in the corresponding system. To resolve the issue, follow the instructions in the owner's manual.





Indicator	Name	On/Blinking	Explanation
 <p>(Red)</p>	<p>Parking Brake and Brake System Indicator (Red)</p>	<ul style="list-style-type: none"> • Comes on when the parking brake is applied, and goes off when it is released. • Comes on when the brake fluid level is low. 	<ul style="list-style-type: none"> • The beeper sounds and the indicator comes on if you drive with the parking brake applied. • Comes on for about 30 seconds when you apply the electric parking brake while the power mode is in ACCESSORY or VEHICLE OFF, then goes off. • Stays on for about 30 seconds when you set the power mode to VEHICLE OFF while the electric parking brake is applied, then goes off. • Comes on while driving - Make sure the parking brake is released. Stop in a safe place and check the brake fluid level. <ul style="list-style-type: none"> ➤ What to do when the indicator comes on while driving P. 595

Indicator	Name	On/Blinking	Explanation
 <p>(Red)</p>	<p>Parking Brake and Brake System Indicator (Red)</p>	<ul style="list-style-type: none"> • Comes on if there is a problem with the brake system. 	<ul style="list-style-type: none"> • Comes on along with the ABS indicator - Have your vehicle checked by a dealer. <ul style="list-style-type: none"> ▣ If the Brake System Indicator (Red) Comes On or Blinks P. 595 • Comes on along with the parking brake and brake system indicator (amber) - Immediately stop in a safe place. Contact a dealer for repair. The brake pedal becomes harder to operate. Depress the pedal further than you normally do. <ul style="list-style-type: none"> ▣ If the Brake System Indicator (Red) Comes On or Blinks at the Same Time When the Brake System Indicator (Amber) Comes On P. 597 • Blinks and the parking brake and brake system indicator (amber) comes on at the same time - There is a problem with the electric parking brake system. The parking brake may not be set. Avoid using the parking brake and have your vehicle checked by a dealer immediately. <ul style="list-style-type: none"> ▣ If the Brake System Indicator (Red) Comes On or Blinks at the Same Time When the Brake System Indicator (Amber) Comes On P. 597





Indicator	Name	On/Blinking	Explanation
	Automatic Brake Hold System Indicator	<ul style="list-style-type: none"> Comes on when the automatic brake hold system is on. 	<ul style="list-style-type: none"> ➤ Automatic Brake Hold P. 475
	Automatic Brake Hold Indicator	<ul style="list-style-type: none"> Comes on when the automatic brake hold is activated. 	<ul style="list-style-type: none"> ➤ Automatic Brake Hold P. 475
 (Amber)	Parking Brake and Brake System Indicator (Amber)	<ul style="list-style-type: none"> Comes on if there is a problem with a system related to braking other than the conventional brake system. Comes on if there is a problem with the cooperative control with regenerative braking, the electric servo brake system. Comes on if there is a problem with the electric parking brake system and/or the automatic brake hold system. 	<ul style="list-style-type: none"> Comes on while driving - Avoid high speeds and sudden braking. Take the vehicle to a dealer immediately. Stays on constantly - Avoid using the parking brake and have your vehicle checked by a dealer immediately.

Indicator	Name	On/Blinking	Explanation
	Malfunction Indicator Lamp	<ul style="list-style-type: none"> • Comes on if there is a problem with the emissions control systems. • Blinks when a misfire in the engine's cylinders is detected. 	<ul style="list-style-type: none"> ▶ If the Malfunction Indicator Lamp Comes On or Blinks P. 594
	Power System Indicator	<ul style="list-style-type: none"> • Comes on if there is a problem with the electric vehicle system. 	<ul style="list-style-type: none"> • Have your vehicle checked by a dealer. • Stop Driving When Safe displays on the driver information interface - Immediately stop in a safe place and contact a dealer.
	Ready Indicator	<ul style="list-style-type: none"> • Comes on when the vehicle is ready to drive. 	<ul style="list-style-type: none"> ▶ Turning on the Power P. 359
	EV Indicator	<ul style="list-style-type: none"> • Comes on when the vehicle is moved by the motor, and the engine is not operating. 	—
	12-Volt Battery Charging System Indicator	<ul style="list-style-type: none"> • Comes on when the 12-volt battery is not charging. 	<ul style="list-style-type: none"> • Stop in a safe place and contact a dealer immediately. ▶ Checking the 12-Volt Battery P. 546 ▶ If the 12-Volt Battery Charging System Indicator Comes On P. 593



Indicator	Name	On/Blinking	Explanation
	Transmission System Indicator	<ul style="list-style-type: none"> • Blinks if the transmission system has a problem. 	<ul style="list-style-type: none"> • Blinks while driving - Avoid sudden starts and acceleration and have your vehicle checked by a dealer immediately. • Do Not Drive displays on the driver information interface - Immediately stop in a safe place and contact a dealer.
	Shift Position Indicator	<ul style="list-style-type: none"> • Indicates the current shift position. 	<p>➤ Shifting P. 365</p>
	Deceleration Paddle Selector Indicator	<ul style="list-style-type: none"> • Comes on when the paddle selector is pulled. • Blinks when deceleration does not occur while pulling the paddle selector. • Comes on with M when SPORT mode is selected or the shift position is in B, and the paddle selector is pulled. 	<p>➤ Deceleration Paddle Selector P. 367</p>



Indicator	Name	On/Blinking	Explanation
	Seat Belt Reminder Indicator	<ul style="list-style-type: none"> • Comes on if you are not wearing a seat belt when you set the power mode to ON. • If the front passenger is not wearing a seat belt, the indicator comes on a few seconds later. • Comes on for a while when the rear seat belt is unfastened while the power mode is ON. • Blinks while driving if you and/or any passenger has not fastened a seat belt. The beeper sounds and the indicator blinks at regular intervals. 	<ul style="list-style-type: none"> • The beeper stops and the indicator goes off when you and the passengers fasten their seat belts. • Stays on after you and/or the passengers have fastened the seat belt(s) - A detection error may have occurred in the sensor. Have your vehicle checked by a dealer. <ul style="list-style-type: none"> ► Seat Belt Reminder P. 47
	Low Fuel Indicator	<ul style="list-style-type: none"> • Comes on when the fuel reserve is running low (approximately 5.3 Litres/1.17 Imp gal left). • Blinks if there is a problem with the fuel gauge. 	<ul style="list-style-type: none"> • Comes on - Refuel your vehicle as soon as possible. • Blinks - Have your vehicle checked by a dealer.
	Anti-lock Brake System (ABS) Indicator	<ul style="list-style-type: none"> • Comes on if there is a problem with the ABS. 	<ul style="list-style-type: none"> • Stays on constantly - Have your vehicle checked by a dealer. With this indicator on, your vehicle still has normal braking ability but no anti-lock function. <ul style="list-style-type: none"> ► Anti-lock Brake System (ABS) P. 478
	Supplemental Restraint System Indicator	<ul style="list-style-type: none"> • Comes on if a problem with any of the following is detected: <ul style="list-style-type: none"> - Supplemental restraint system - Side airbag system - Side curtain airbag system - Seat belt tensioner 	<ul style="list-style-type: none"> • Stays on constantly - Have your vehicle checked by a dealer.









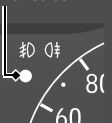

Indicator	Name	On/Blinking	Explanation
	Passenger Front Airbag On/Off Indicators	<ul style="list-style-type: none"> When the passenger front airbag is active: The on indicator comes back on and remains on for about 60 seconds. When the passenger front airbag is inactive: The off indicator comes back on and stays on. This is a reminder that the passenger front airbag is deactivated. 	<ul style="list-style-type: none"> ➤ Passenger Front Airbag Off System P. 63
	Vehicle Stability Assist (VSA) System Indicator	<ul style="list-style-type: none"> Blinks when VSA is active. 	—
		<ul style="list-style-type: none"> Comes on if there is a problem with the VSA system, agile handling assist or hill start assist system. 	<ul style="list-style-type: none"> Stays on constantly - Have your vehicle checked by a dealer. <ul style="list-style-type: none"> ➤ Vehicle Stability Assist (VSA) System P. 389 ➤ Hill start assist system P. 361
	Vehicle Stability Assist (VSA) OFF Indicator	<ul style="list-style-type: none"> Comes on if the VSA system is deactivated temporarily after the 12-volt battery has been disconnected, then re-connected. 	<ul style="list-style-type: none"> Drive a short distance at more than 20 km/h (12 mph). The indicator should go off. If it does not, have your vehicle checked by a dealer.
		<ul style="list-style-type: none"> Comes on when you partially disable VSA. Comes on if the VSA system is deactivated temporarily after the 12-volt battery has been disconnected, then re-connected. 	<ul style="list-style-type: none"> ➤ VSA On and Off P. 390 Drive a short distance at more than 20 km/h (12 mph). The indicator should go off. If it does not, have your vehicle checked by a dealer.









Indicator	Name	On/Blinking	Explanation
	Electric Power Steering (EPS) System Indicator	<ul style="list-style-type: none"> Comes on if there is a problem with the EPS System. 	<ul style="list-style-type: none"> Stays on constantly - Have your vehicle checked by a dealer. Do Not Drive displays on the driver information interface - Immediately stop in a safe place and contact a dealer. <ul style="list-style-type: none"> ➤ If the Electric Power Steering (EPS) System Indicator Comes On P. 596
	Turn Signal and Hazard Warning Indicators	<ul style="list-style-type: none"> Blinks when you operate the turn signal lever. Blink along with all turn signals when you press the hazard warning button. 	<ul style="list-style-type: none"> Does not blink or blinks rapidly <ul style="list-style-type: none"> ➤ Replacing Light Bulbs P. 530
		<ul style="list-style-type: none"> Blink along with all turn signals when you depress the brake pedal while the high speed driving. 	<ul style="list-style-type: none"> ➤ Emergency Stop Signal P. 480
	High-Beam Indicator	<ul style="list-style-type: none"> Comes on when the high beam headlights are on. 	—
	Lights On Indicator	<ul style="list-style-type: none"> Comes on when the position, tail, and other external lights are on. 	➤ Lights P. 183
	Front Fog Light Indicator*	<ul style="list-style-type: none"> Comes on when the front fog lights are on. 	➤ Fog Lights P. 187





* Not available on all models



Indicator	Name	On/Blinking	Explanation
	Rear Fog Light Indicator	<ul style="list-style-type: none"> • Comes on when the rear fog light is on. 	<p>☒ Fog Lights P. 187</p>
	Low Tyre Pressure/Deflation Warning System Indicator	<ul style="list-style-type: none"> • May come on briefly if the power mode is set to ON and the vehicle is not moved within 45 seconds, to indicate the initialisation process is not yet complete. • Comes on and stays on when: <ul style="list-style-type: none"> - One or more tyres' pressures are determined to be significantly low. - The system has not been initialised. • Blinks for about one minute, and then stays on if there is a problem with the deflation warning system. • Comes on if the deflation warning system is deactivated temporarily after the 12-volt battery has been disconnected, then reconnected. 	<ul style="list-style-type: none"> • Comes on while driving - Stop in a safe place, check tyre pressures, and inflate the tyre(s) if necessary. • Stays on after the tyres are inflated to the recommended pressures - The system needs to be initialised. <ul style="list-style-type: none"> ☒ Deflation Warning System Calibration P. 392 • Blinks and remains on - Have your vehicle checked by a dealer. • Drive a short distance at more than 20 km/h (12 mph). The indicator should go off. If it does not, have your vehicle checked by a dealer.

Indicator	Name	On/Blinking	Explanation
	Auto High-Beam Indicator	<ul style="list-style-type: none"> Comes on when all the operating conditions of the auto high-beam are met. 	<p>➤ Auto High-Beam P. 193</p>
<p>Indicator</p> 	Immobilizer System Indicator	<ul style="list-style-type: none"> Blinks if the immobilizer system cannot recognise the key information. 	<ul style="list-style-type: none"> Blinks - You cannot start the engine. Set the power mode to VEHICLE OFF, then select the ON mode again. <ul style="list-style-type: none"> Right-hand drive type Depress and hold the brake pedal before setting the power mode to ON. All models Repeatedly blinks - The system may be malfunctioning. Have your vehicle checked by a dealer. Do not attempt to alter this system or add other devices to it. Electrical problems can occur.
<p>Indicator</p> 	Security System Alarm Indicator	<ul style="list-style-type: none"> Blinks when the security system alarm has been set. 	<p>➤ Security System Alarm P. 175</p>



Indicator	Name	On/Blinking	Explanation
	ECON Mode Indicator	<ul style="list-style-type: none"> Comes on when you set the drive mode to ECON. 	<ul style="list-style-type: none">  ECON Mode P. 373
	SPORT Mode Indicator	<ul style="list-style-type: none"> Comes on when you set the drive mode to SPORT. 	<ul style="list-style-type: none"> The ambient meter remains lit up in red as long as SPORT mode is selected.  Drive Mode Switch P. 371
	NORMAL Mode Indicator	<ul style="list-style-type: none"> Comes on when you set the drive mode to NORMAL. 	<ul style="list-style-type: none">  Drive Mode Switch P. 371
	System Message Indicator	<ul style="list-style-type: none"> Comes on along with a beep when a problem is detected. A system message on the driver information interface appears at the same time. 	<ul style="list-style-type: none"> While the indicator is on, press the  (home) button, and select Information to see the message again.  Switching the Display P. 135 Refer to the Indicators information in this chapter when a system message appears on the driver information interface. Respond to the message accordingly. The driver information interface does not return to the normal screen unless the warning is cancelled, or the  (home) button is pressed.



Indicator	Name	On/Blinking	Explanation
	Adjustable Speed Limiter Indicator (White/Green)	<ul style="list-style-type: none"> Lights up in white when you press the  button. If a different indicator comes on, subsequently press the LIM button. Lights up in green when the adjustable speed limiter is set. 	 Adjustable Speed Limiter P. 376
	Intelligent Speed Limiter Indicator (White/Green)	<ul style="list-style-type: none"> Lights up in white when you press the  button. If a different indicator comes on, subsequently press the LIM button. Lights up in green when you press the RES/+ button or SET/- button. 	 Intelligent Speed Limiter P. 382
	Hill Descent Control System Indicator (White/Green)	<ul style="list-style-type: none"> Lights up in white when the hill descent control system is on and ready to use. Lights up in green when the hill descent control system is in operation. 	 Hill Descent Control System P. 374

Indicator	Name	On/Blinking	Explanation
	Adaptive Cruise Control (ACC) with Low Speed Follow Indicator (Amber)	<ul style="list-style-type: none"> • Comes on if there is a problem with ACC with Low Speed Follow. • Comes on if the ACC with Low Speed Follow is deactivated temporarily after the 12-volt battery has been disconnected, then re-connected. • Indicator may come on temporarily when the maximum permissible weight is exceeded. • ACC with Low Speed Follow has been automatically cancelled. 	<ul style="list-style-type: none"> • Comes on while driving - Have your vehicle checked by a dealer. • Drive a short distance at more than 20 km/h (12 mph). The indicator should go off. If it does not, have your vehicle checked by a dealer. • Make sure the total load is within the maximum permissible weight. <ul style="list-style-type: none"> ▣ Load Limit P. 355 • Stays on constantly - Have your vehicle checked by a dealer.
	Adaptive Cruise Control (ACC) with Low Speed Follow Indicator (White/Green)	<ul style="list-style-type: none"> • Lights up in white when you press the  button. • If a different indicator comes on, subsequently press the LIM button. • Lights up in green when you press the RES/+ button or SET/- button. 	<ul style="list-style-type: none"> ▣ Adaptive Cruise Control (ACC) with Low Speed Follow P. 423
	Lane Keeping Assist System (LKAS) Indicator (Amber)	<ul style="list-style-type: none"> • Comes on if there is a problem with the LKAS. • Indicator may come on temporarily when the maximum permissible weight is exceeded. 	<ul style="list-style-type: none"> • Stays on constantly - Have your vehicle checked by a dealer. • Make sure the total load is within the maximum permissible weight. <ul style="list-style-type: none"> ▣ Load Limit P. 355 • Stays on constantly - Have your vehicle checked by a dealer.

Indicator	Name	On/Blinking	Explanation
	Lane Keeping Assist System (LKAS) Indicator (White/Green)	<ul style="list-style-type: none"> Lights up in white when you press the LKAS button. Lights up in green when the LKAS is in operation. 	<p>▶ Lane Keeping Assist System (LKAS) P. 441</p>
	Road Departure Mitigation Ready to Assist Indicator	<ul style="list-style-type: none"> Comes on when all activation conditions for the Road Departure Mitigation system are satisfied and lane markers are detected. 	<p>▶ Road Departure Mitigation System P. 453</p>
	Safety Support Indicator (Amber)	<ul style="list-style-type: none"> Comes on if there is a problem with Road Departure Mitigation system, CMBS, Low Speed Braking Control, or blind spot information system*. Indicator may come on temporarily when the maximum permissible weight is exceeded. Comes on if the Road Departure Mitigation system, CMBS, and Low Speed Braking Control are deactivated temporarily after the 12-volt battery has been disconnected and then re-connected. 	<ul style="list-style-type: none"> Stays on constantly - Have your vehicle checked by a dealer. Make sure the total load is within the maximum permissible weight. <ul style="list-style-type: none"> ▶ Load Limit P. 355 Stays on constantly - Have your vehicle checked by a dealer. Drive a short distance at more than 20 km/h (12 mph). The indicator should go off. If it does not, have your vehicle checked by a dealer.

* Not available on all models

Indicator	Name	On/Blinking	Explanation
	<p>Safety Support Indicator (Amber)</p>	<ul style="list-style-type: none"> Comes on when the Road Departure Mitigation system and/or CMBS shuts itself off. 	<ul style="list-style-type: none"> Stays on - The temperature inside the camera is too high. Use the climate control system to cool down the camera. The system activates when the temperature inside the camera cools down. <ul style="list-style-type: none">  Front Wide View Camera P. 468 Stays on - The area around the camera is blocked by dirt, mud, etc. Stop your vehicle in a safe place and wipe the debris off with a soft cloth. Have your vehicle checked by a dealer if the indicator and message are still displayed even after you have cleaned the area around the camera. <ul style="list-style-type: none">  Front Wide View Camera P. 468 It may come on when the ambient conditions are dark, such as when driving in a tunnel, or at night, dawn, or dusk.

Indicator	Name	On/Blinking	Explanation
	Safety Support Indicator (Amber)	<ul style="list-style-type: none"> • Comes on when mud, snow, or ice accumulates in the vicinity of sonar. 	<ul style="list-style-type: none"> • Remove the obstacle in the vicinity of the sonar sensor. <ul style="list-style-type: none"> ➤ Low Speed Braking Control P. 417
		<p>Models with blind spot information system</p> <ul style="list-style-type: none"> • Comes on when mud, snow, or ice accumulates in the vicinity of the blind spot information system sensor. • Comes on when the temperature of the blind spot information system sensor is high. 	<ul style="list-style-type: none"> • Comes on while driving - Something may be interfering with the blind spot information system sensor. Check the vicinity of the blind spot information system sensor and remove any obstacles. • The system will return to normal when the temperature cools down. <ul style="list-style-type: none"> ➤ Blind spot information System* P. 394
	Safety Support Indicator (Green/Grey)	<ul style="list-style-type: none"> • Lights up in green when Road Departure Mitigation system, CMBS, Low Speed Braking Control, and blind spot information system* are on. • Lights up in green and grey when Road Departure Mitigation system, CMBS, Low Speed Braking Control, or blind spot information system*, or any two or three of these systems are off. • Lights up in grey when the Road Departure Mitigation system, CMBS, Low Speed Braking Control, and blind spot information system* are off. 	<ul style="list-style-type: none"> ➤ Road Departure Mitigation system On and Off P. 456 ➤ CMBS On and Off P. 409 ➤ Blind spot information System On and Off P. 397 ➤ System On and Off P. 420

* Not available on all models

Driver Information Interface Warning and Information Messages

The warning and information messages appear only on the driver information interface. Press the  (home) button, select **Information**, then press the left selector wheel to see the message again with the system message indicator on.

■ Icons

Since messages will not display on the driver information interface when Warning Message is set to OFF, you can check the messages below. Please take the appropriate action outlined in the message, such as contacting a dealer.







- **Red Icons** P. 121
- **Amber Icons** P. 122
- **Green Icons** P. 127
- **Other Icons** P. 128







Display messages by setting **Warning Message** to ON. You can also change the message language.

- **Customized Features** P. 304







■ Red Icons









Icon	Message
	Critical System Failure Detected. Stop Driving When Safe
	Steering Assist Reduced. Stop Driving When Safe.
	Brake Performance Reduced. Stop Driving When Safe.
	Brake Fluid Low. Check Fluid Level.
	Parking Brake Engaged
	Release Parking Brake
	Cannot Set Cruise: Parking Brake Is Applied
	Cruise Cancelled: Parking Brake Was Applied
	Brake System Problem. Brake Performance May Be Reduced.

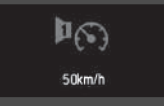





Icon	Message
	Brake System Problem. Brake Performance May Be Reduced.
	Fasten Seat Belt
	Fasten Passenger's Seat Belt
	➤ Seat Belt Reminder P. 47
	12 Volt Battery Charging System Problem. Do Not Drive.
	Engine Oil Pressure Low. Stop Engine. ➤ If the Engine Oil Pressure Low Warning Appears P. 593

Icon	Message
	Engine Temperature Too Hot. Allow Engine To Cool. <ul style="list-style-type: none"> Overheating P. 591
	Supplemental Restraint System Problem
	Check Rear Seats
	Steering Required
	Lane Departure
	Parking Sensor System Problem







■ Amber Icons





Icon	Message
	Apply Parking Brake To Keep Vehicle Stationary
	System Problem. Shift To Park.
	Shift To Park
	<ul style="list-style-type: none"> Adaptive Cruise Control (ACC) with Low Speed Follow P. 423 Collision Mitigation Braking System (CMBS) P. 405 Low Speed Braking Control P. 417
	Lane Departure
	Temperature Too Low For Vehicle To Operate
	Please Wait While Vehicle Warms Up





Icon	Message
	 Speed Alarm P. 144
	Emissions System Problem. Power May Be Reduced. Emission System Problem. Avoid Strong Acceleration And High Speed. Emission System Problem. Do Not Drive.
	Engine Oil Level Low. Check Engine Oil Level.
	Engine Oil Level Low. Check Engine Oil Level.  If the Engine Oil Level Low Warning Appears P. 599
	Engine Cooling System Problem. Power May Be Reduced.
	Fuel Gauge System Problem. Level Not Accurate.

Icon	Message
	Fuel Low
	Transmission System Problem. Performance May Be Reduced.
	Transmission System Problem. Do Not Drive.
	Anti-Lock Brake System Problem. Brake Performance May Be Reduced.
	Brake System Problem. Brake Performance May Be Reduced.
	Brake System Problem. Do Not Depress Brake + Accelerator Together.
	Brake System Problem. Brake Performance May Be Reduced.

Icon	Message
	Brake System Problem. Brake Performance May Be Reduced.
	Reduced Stopping Power. Avoid Heavy Deceleration And High Speed.
	Electric Parking Brake System Problem. Parking Brake Not Available.
	Vehicle Stability Assist System Problem. Traction And Handling May Be Reduced.
	Drive Carefully. Systems Initializing...
	Hill Start Assist Problem. Vehicle May Roll Upon Brake Release.
	Hill Descent Control System Problem. Apply Brake When Descending.





Icon	Message
	Brake Hold System Problem. Apply Brake When Stopped.
	Apply Brake Pedal Cruise Cancelled: Depress Brake Pedal
	To Release Parking Brake: Brake + Push
	Models with power tailgate Power Tailgate System Problem. Operate Tailgate Manually.
	Electric Power Steering System Problem. Steering Assist Reduced.
	Electric Power Steering System Problem. No Steering Assist. Do Not Drive.



Icon	Message
	Automatic Lighting Control System Problem. Manual Controls Available.
	Headlight System Problem. Headlight Performance May Be Reduced.
	Auto High-Beam Problem. Manual Controls Available.
	Keyless Remote Not Detected
	Change Keyless Remote Battery ➤ Replacing the Remote Battery P. 552

Icon	Message
	Smart Entry System Problem
	Digital Key System Problem
	Carry Digital Key And Switch Vehicle OFF When Exiting
	Tyre Pressure Monitor System Problem
	Tyre Pressures Low. Check All Tyres And Initialise Deflation Warning System

Icon	Message
	Adaptive Cruise Control System Problem
	Collision Mitigation Braking System Problem
	Low Speed Braking Control Problem.
	Low Speed Braking Control Problem. Parking Sensor Obstructed.
	Lane Keeping Assist System Problem
	Road Departure Mitigation System Problem

Icon	Message
	Models with service reminder system Service Due Soon ➤ Service Reminder System* P. 504
	Models with service reminder system Service Due Now ➤ Service Reminder System* P. 504
	Models with service reminder system Service Overdue ➤ Service Reminder System* P. 504
	Models with blind spot information system Blind Spot Information System Problem
	Models with blind spot information system Blind Spot Information Not Available





Icon	Message
	Check Charging System
	High Voltage Battery Charge Too Low. Vehicle Cannot Start
	Low Charge. Power Reduced.
	Low Temperature. Power Reduced.
	High Temperature. Power Reduced.
	Hybrid System Problem. Power Reduced.
	Check 12 Volt Charging System. Power Reduced.



Icon	Message
	Acoustic Vehicle Alerting System Problem
	Power System Problem. Power May Be Reduced.
	Power System Problem. Stop Driving When Safe.
	Power System Problem. Avoid Strong Acceleration And High Speed.



■ Green Icons



Icon	Message
	Brake Hold System Standby

■ Other Icons

Icon	Message
	Avoid Strong Acceleration And High Speed. Engine Temperature Near Limit
	Gear Position Is N. Release Accelerator Pedal
	Cannot Set Cruise: Brake Pedal Is Applied
	Brake Hold System OFF



Icon	Message
	To Enable Brake Hold: Seat Belt + Push
	To Disable Brake Hold: Brake + Push
	Cannot Set Hill Descent Control: Cruise Is Active
	Cannot Set Hill Descent Control: Speed Too High
	Hill Descent Control OFF: Speed Too High
	Hill Decent Control Cancelled: Slope Not Steep Enough

Icon	Message
	Cannot Set Hill Descent Control: Cruise Is Active
	Cannot Set Cruise: Hill Descent Control Is Active
	To Enable Brake Hold: Fasten Seat Belt
	Fasten Seat Belt
	Cannot Set Cruise: Fasten Seat Belt
	Cruise Cancelled: Fasten Seat Belt

Icon	Message
	Cannot Set Cruise: Speed Too High
	Cruise Cancelled: Speed Too High
	Cannot Set Cruise: System Not Available
	Cruise Cancelled: System Not Available
	Cruise Will Cancel Soon
	Cannot Set Cruise: Too Close To Vehicle Ahead
	Cruise Cancelled: Too Close To Vehicle Ahead

Icon	Message
	Cannot Set Cruise: Slope Too Steep
	Cruise Cancelled: Slope Too Steep
	Cannot Set Cruise: Slope Too Steep
	Cruise Cancelled: Slope Too Steep
	Cannot Set Cruise: Shift To Drive
	Cruise Cancelled: Shift To Drive
	To Resume Cruise: Use "RES/+" Switch
	Cruise Cancelled: Loss Of Traction

Icon	Message
	Press Switch To Operate
	Press Switch To Operate ACC
	Low Speed Braking Control Activated. Object Detected.
	Lane Keeping Assist Cannot Operate
	Some Driver Assist Systems Cannot Operate: Clean Front Windscreen Or Poor Viewing Condition.

Icon	Message
	Road Departure Mitigation Activated
	Some Driver Assist Systems Available
	To Start Vehicle: Brake + Push
	To Start Vehicle: Fully Depress Brake + Push
	To Continue To Drive: Depress Brake Pedal And Push Switch

Icon	Message
	To Unlock Wheel: Push + Turn
	To Turn Vehicle OFF: Push Twice
	Accessory Mode Fully Release Brake + Push
	To Start, Hold Remote Near Start Button ➤ If the Keyless Remote Battery is Weak P. 584
	Pressing Twice Or Holding Will Cause IGN OFF
	Ready To Drive

Gauges

Gauges include the speedometer, fuel gauge, and other related indicators. They are displayed when the power mode is in ON.

■ Speedometer

Displays your driving speed in km/h or mph.

■ Fuel Gauge

Displays the amount of fuel left in the fuel tank.

■ POWER/CHARGE Gauge

■ Electric motor

The degree to which the electric motor is being powered is displayed by the readings on the **POWER** side.

■ Battery charge in progress

The degree to which the High Voltage battery is being charged is displayed by the readings on the **CHARGE** side.

☞ Speedometer

You can set the speedometer and the displayed measurements to read in either km/h and mph.

☞ **Change Units** P. 137

☞ Fuel Gauge

NOTICE

You should refuel when the reading approaches **0**. Running out of fuel can cause the engine to misfire, damaging the catalytic converter.

The actual amount of remaining fuel may differ from the fuel gauge reading.

■ Odometer

Shows the total number of kilometres that your vehicle has accumulated.

■ Ambient Meter

Changes to green to indicate that the vehicle is being driven in a fuel efficient manner with the **SPORT** mode off.

■ Outside Temperature

Shows the outside temperature in Celsius.

If the outside temperature has been below 3°C at the time you set the power mode to ON,  message appears on the driver information interface.

■ Adjusting the outside temperature display

Adjust the temperature reading by up to $\pm 3^{\circ}\text{C}$ if the temperature reading seems incorrect.

⊗ Outside Temperature

The temperature sensor is in the front bumper. Road heat and exhaust from another vehicle can affect the temperature reading when your vehicle speed is less than 30 km/h (19 mph).

It may take several minutes for the display to be updated after the temperature reading has stabilised.

You can adjust the temperature reading.

➤ **Customized Features** P. 304

■ Clock

Shows the clock.

You can adjust the time manually or change the clock display to show the 12 hour clock or 24 hour clock.

➤ **Clock Setup** P. 266

■ Current Mode for ACC with Low Speed Follow and the LKAS

Shows the current mode for ACC with Low Speed Follow and LKAS.

➤ **Adaptive Cruise Control (ACC) with Low Speed Follow** P. 423

➤ **Lane Keeping Assist System (LKAS)** P. 441

■ Traffic Sign Recognition System

Shows traffic signs while driving.

The indicator blinks when the maximum speed of the traffic sign detected by the Traffic Sign Recognition System is exceeded.

➤ **Traffic Sign Recognition System** P. 461

Driver Information Interface

The driver information interface shows information such as the estimated travelable distance and fuel economy of the vehicle. It also displays messages such as warnings and other helpful information.

When a warning message displays, please check the message and contact a dealer and have the vehicle inspected if necessary. Please refer to the pages below if the

Engine Oil Pressure Low, Engine Temperature Too Hot or **Reduced Stopping Power** message is displayed.

➤ **If the Engine Oil Pressure Low Warning Appears** P. 593

➤ **Overheating** P. 591

➤ **If the Reduced Stopping Power Warning Appears** P. 594

Switching the Display

Press the  (home) button, then roll the left selector wheel to scroll to the content you want to see. Press the left selector wheel to see detailed information.

Switching the Display

To go back to the previous screen, press the  (back) button.

You can add or delete the meter contents.

➤ **Customize Display** P. 148

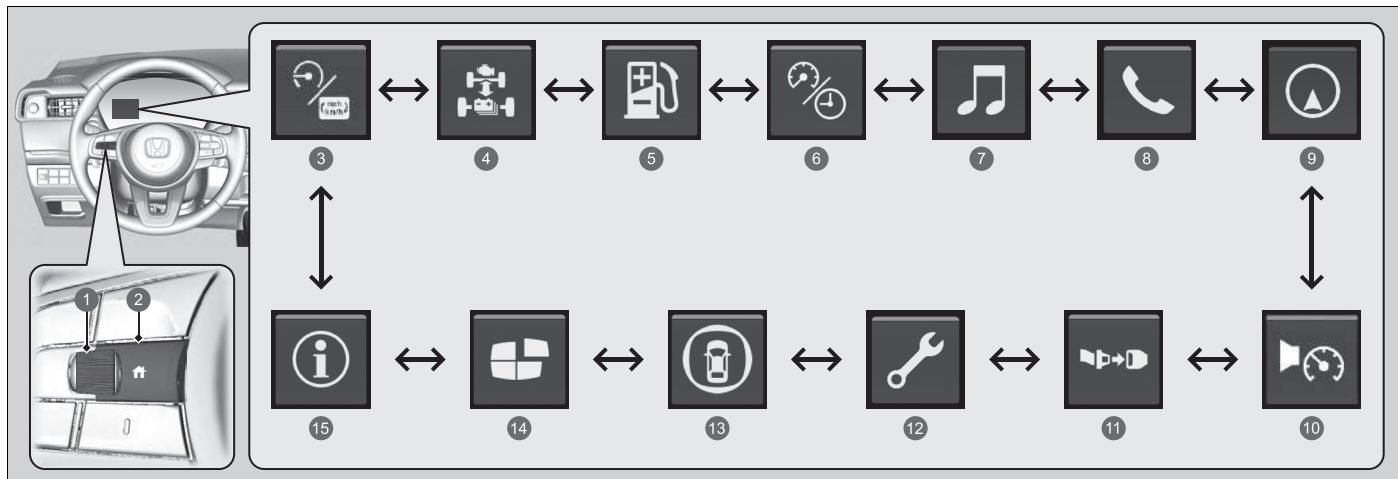

- 1 Left Selector Wheel
- 2 (Home) Button
- 3 **Power /Charge** P. 137
- 4 **Power Flow** P. 138
- 5 **Range & Fuel** P. 139

- 6 **Speed & Time** P. 141
- 7 **Audio** P. 143
- 8 **Phone** P. 143
- 9 **Navigation** P. 143
- 10 **Speed Alarm** P. 144

- 11 **Seat Belts** P. 145
- 12 **Maintenance*** P. 145
- 13 **Safety Support** P. 146
- 14 **Customize Display** P. 148
- 15 **Information** P. 148

■ Power/Charge

Shows the degree to which the electric motor is being powered and the High Voltage battery is being charged. Other contents will be hidden.

🔍 **POWER/CHARGE Gauge** P. 132

■ Change Units

Enables you to show another unit on the driver information interface and audio/information screen and set the displayed measurements to read in either km and miles, km/h and mph.

Press and hold the left selector wheel when you select **Power/Charge** on the driver information interface. Each time you do this, the unit will change from **km, km/h** to **miles, mph** or vice versa. After this, a confirmation screen will appear for a few seconds.

■ Power Flow/Engine Status Display/High Voltage Battery Charge Level Gauge

Displays the power flow of the motor and engine, indicating the vehicle's power source and whether the battery is being charged.

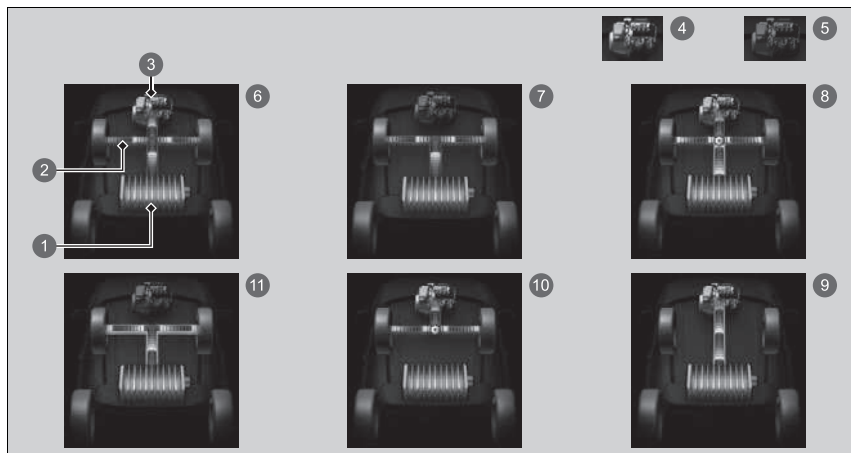

- ① High Voltage Battery Charge Level Gauge
- ② Power Flow ③ Engine ④ Engine ON ⑤ Engine OFF
- ⑥ **Hybrid (HV):** Power is supplied by the motor and the engine.
- ⑦ **Electric Vehicle (EV):** Power is supplied by the motor.
- ⑧ **Engine (Direct Drive):** The engine is running and the motor is charging the High Voltage battery.
- ⑨ The engine is running and the motor is charging the High Voltage battery.
- ⑩ Power is being supplied by the engine only.
- ⑪ **Regeneration:** The motor is charging the High Voltage battery.

▶ Power Flow/Engine Status Display/High Voltage Battery Charge Level Gauge

The high voltage battery charge level may decrease under the following conditions:

- When the 12-volt battery has been replaced.
- When the 12-volt battery has been disconnected.
- When the high voltage battery control system corrects its reading.

The charge level reading will be corrected automatically while driving.

Changes in the temperature of the high voltage battery can increase or decrease the battery's charging capacity. If the temperature changes cause the battery's capacity to change, the number of indicators in the battery charge level gauge may also change, even if the amount of charge remains the same.

While the vehicle is stationary with the engine running, the following may appear on the driver information interface.

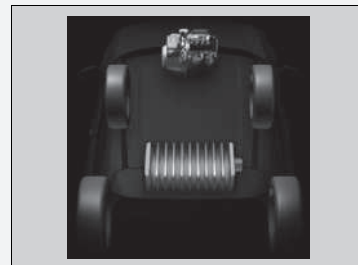

Range / Fuel / Trip Meter

Roll the left selector wheel to switch between trip meter A and trip meter B.

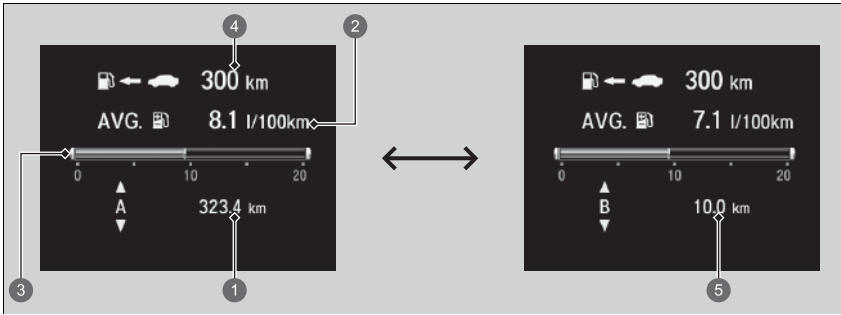

- ① Trip Meter A
- ② Average Fuel Economy
- ③ Instant Fuel Economy
- ④ Range
- ⑤ Trip Meter B

■ Trip meter

Shows the total number of kilometres or miles driven since the last reset. Meters A and B can be used to measure two separate trips.

Resetting a trip meter

To reset the trip meter, display it, press the left selector wheel and then select **Reset**. The trip meter is reset to **0.0**.

■ Average fuel economy

Shows the estimated average fuel economy of each trip meter in l/100km or mpg. The display is updated at set intervals. When a trip meter is reset, the average fuel economy is also reset.

■ Instant fuel economy

Shows the instant fuel economy as a bar graph in l/100 km or mpg.

■ Range

Shows the estimated distance you can travel on the remaining fuel. This estimated distance is based on the vehicle's current fuel economy.

⌘ Average fuel economy

You can change when to reset the average fuel economy.

➤ **Customized Features** P. 304

Speed & Time

Roll the left selector wheel to switch between trip meter A and trip meter B.

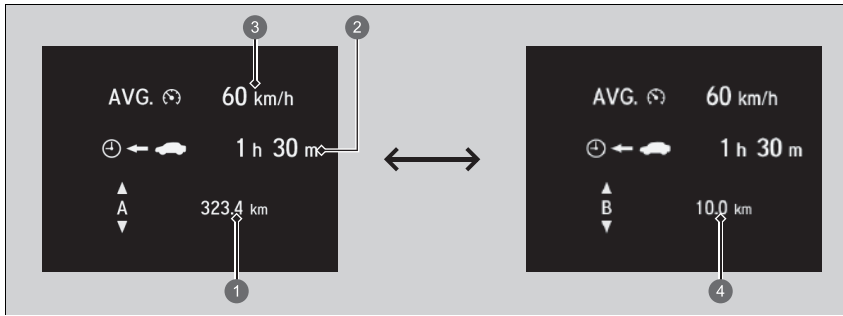

- ① Trip meter A
- ② Elapsed Time
- ③ Average Speed
- ④ Trip meter B

■ Trip meter

➤ **Trip meter** P. 140

■ Elapsed Time

Shows the time elapsed since Trip A or Trip B was reset.

■ Average Speed

Shows the average speed in km/h or mph since Trip A or Trip B was reset.

⌘ Elapsed Time

You can change when to reset the elapsed time.

➤ **Customized Features** P. 304

⌘ Average Speed

You can change when to reset the average speed.

➤ **Customized Features** P. 304

■ Audio

Shows the current audio information.

➤ **Basic Operation** P. 249

■ Phone

Shows the current phone information.

➤ **Hands-Free Telephone System** P. 318

■ Navigation

■ Compass

Shows the compass screen.

■ Turn-by-Turn Directions

When driving guidance is provided by the navigation system, Android Auto or Apple CarPlay, turn-by-turn directions to your destination appear.

➤ **Refer to the Navigation System Manual**

➤ **Apple CarPlay** P. 296

➤ **Android Auto** P. 300

☒ Navigation

You can select whether to have the turn-by-turn display come on or not during the route guidance.

➤ **Customized Features** P. 304

When the compass or turn-by-turn directions are displayed, you can control some navigation system functions on the driver information interface by scrolling the left selector wheel.

➤ **Refer to the Navigation System Manual**

Turn-by-turn directions may not be available for all apps.

■ Speed Alarm

Sets the speed alarm on and changes the speed alarm setting.

Roll the left selector wheel, the speed alarm setting changes as follows:

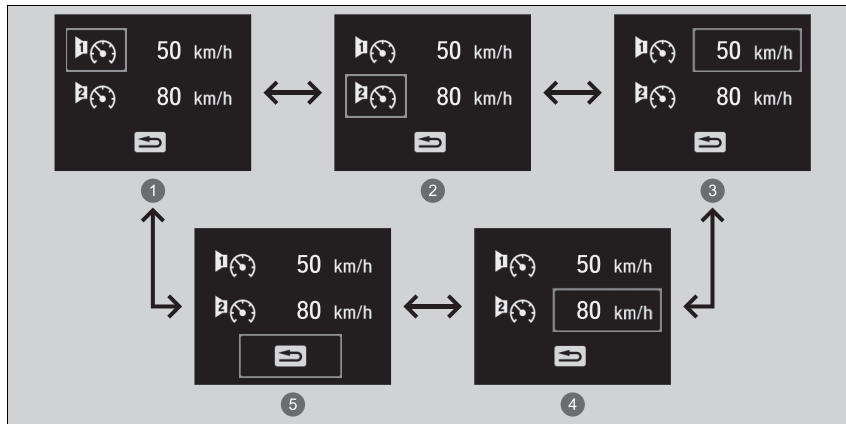

- ① Speed Alarm 1 On/Off*¹
- ② Speed Alarm 2 On/Off*¹
- ③ Speed Alarm 1 Speed Setting [50 km/h (30mph)*¹]
- ④ Speed Alarm 2 Speed Setting [80 km/h (50mph)*¹]
- ⑤ Back

*1:Default Setting

■ Seat Belts

Appears when any of the seat belts are latched or unlatched.

■ Maintenance*

Shows the service reminder system.

🗨 **Service Reminder System*** P. 504

■ Safety Support

Indicates the state of the Road Departure Mitigation system, CMBS, Low Speed Braking Control, and blind spot information system*, such as On, Off, or Failure, by colour and letters.

The following colours indicate the state of any of the above mentioned systems:

- Green: The system is on.
- Grey: The system is off.
- Amber: There is a problem with the system.

☒ Safety Support

If a system is indicated by the colour amber, have your vehicle checked by a dealer immediately.

To turn on or off each system, first rotate the left selector wheel to switch displays. From the next display you can select which system to turn on or off.

- ☒ **Road Departure Mitigation system On and Off** P. 456
- ☒ **Blind spot information System*** P. 394
- ☒ **CMBS On and Off** P. 409
- ☒ **System On and Off** P. 420

You can also confirm the state of the each function by the colour of the safety support indicator.

- ☒ **Safety Support Indicator (Amber)** P. 117
- ☒ **Safety Support Indicator (Green/Grey)** P. 119

Even when the Low Speed Braking Control icon is green, if the parking sensor is turned off for the rear only, the brake assist will not operate when reversing.

- ☒ **Turning off All Rear Sensors** P. 487

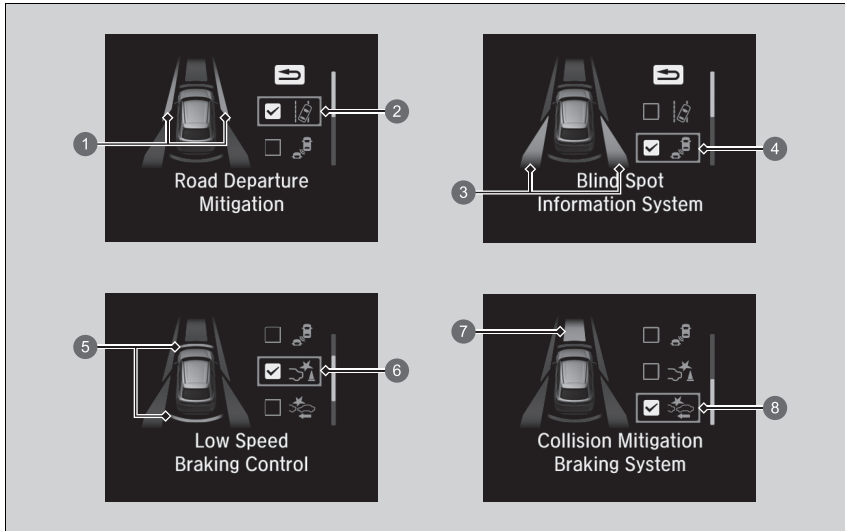

- ❶ Area Info for Road Departure Mitigation System
- ❷ Road Departure Mitigation System Icon and State Info
- ❸ Area Info for Blind spot information System*
- ❹ Blind spot information System Icon and State Info*
- ❺ Area Info for Low Speed Braking Control
- ❻ Low Speed Braking Control Icon and State Info
- ❼ Area Info for CMBS
- ❽ CMBS Icon and State Info

* Not available on all models

Continued

■ Customize Display

Change the settings to your liking.

■ Arrange content

You can choose which icons to display on the home screen.

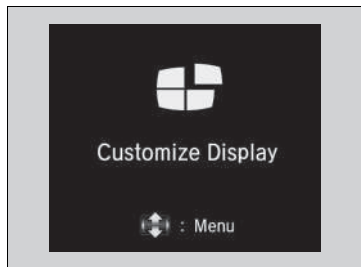

1. Roll the left selector wheel to scroll to select **Customize Display**, then press the left selector wheel.
2. Roll the left selector wheel.
3. Roll the left selector wheel to scroll between icons, then press the left selector wheel to check or uncheck them.

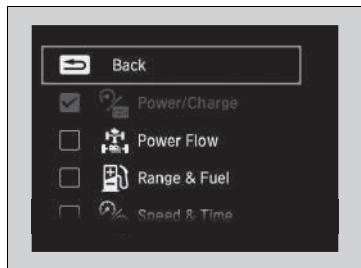

■ Information

You can check if there are any active warning messages.

➤ **Driver Information Interface Warning and Information Messages** P. 120

⌘ Customize Display

Icons that are grey cannot be removed from the home screen.

When you customize settings, shift to [P].

⌘ Information

If there are multiple warnings or informations, you can roll the left selector wheel to see other warnings.

Controls

This chapter explains how to operate the various controls necessary for driving.



Clock	150
Locking and Unlocking the Doors	
Key	151
Low Keyless Remote Signal Strength	153
Locking/Unlocking the Doors from the Outside	154
Locking/Unlocking the Doors from the Inside	160
Childproof Door Locks	162
Tailgate	163
Security System	
Immobilizer System	174

Security System Alarm	175
Super Locking*	176
Windows	177
Operating the Switches Around the Steering Wheel	
POWER Button	180
Lights	183
Active Cornering Lights*	190
Headlight Adjuster*	192
Auto High-Beam	193
Wipers and Washers	196

Rear Demister/Heated Door Mirror Button	199
Heated Windscreen Button*	200
Brightness Control	201
Adjusting the Steering Wheel	202
Mirrors	203
Seats	207
Interior Convenience Items	219
Climate Control System	236

* Not available on all models

Adjusting the Clock

You can adjust the time in the clock display with the power mode in ON.

You can adjust the clock and customize the clock display.

➤ **Clock Setup** P. 266

Adjusting the Clock

The clock in the instrument panel also changes when the audio/information screen clock is adjusted.

Key

This vehicle comes with the following keys:

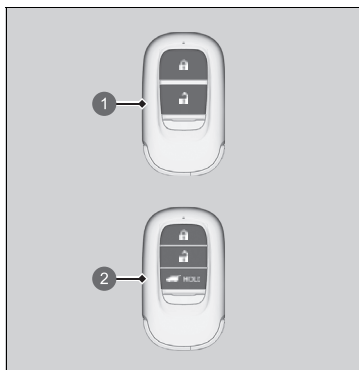

- 1 Keyless Remote
- 2 Keyless Remote with power tailgate button

Use the keys to turn on and off the power system, and to lock and unlock all the doors and tailgate.

Key

All the keys have an immobilizer system. The immobilizer system helps to protect against vehicle theft.

Immobilizer System P. 174

Follow the advice below to prevent damage to the keys:

- Do not leave the keys in direct sunlight, or in locations with high temperature or high humidity.
- Do not drop the keys or set heavy objects on them.
- Keep the keys away from liquids, dust and sand.
- Do not take the keys apart except for replacing the battery.

If the circuits in the keys are damaged, the power system may not activate, and the remote transmitter may not work.

If the keys do not work properly, have them inspected by a dealer.

■ Built-in Key

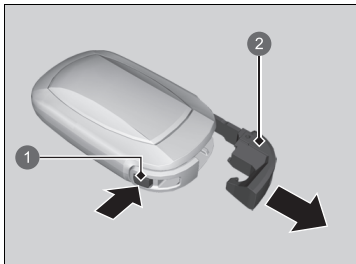

The built-in key can be used to lock/unlock the doors when the keyless remote battery becomes weak and the power door lock/unlock operation is disabled.

To remove the built-in key, pull out the key while pressing the release button. To reinstall the built-in key, push the built-in key into the keyless remote until it clicks.

- ① Release Button
- ② Built-in Key

■ Key Number Tag

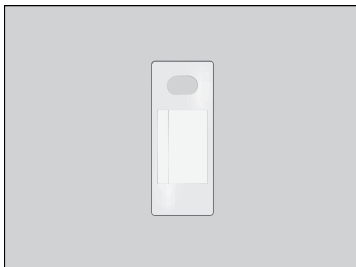

Contains a number that you will need if you purchase a replacement key.

☒ Key Number Tag

Keep the key number tag separate from the key in a safe place outside of your vehicle. If you wish to purchase an additional key, contact a dealer.

If you lose your key and you cannot activate the power system, contact a dealer.

Low Keyless Remote Signal Strength

The vehicle transmits radio waves to locate the keyless remote when locking/unlocking the doors and tailgate, or to activate the power system.

In the following cases, locking/unlocking the doors and tailgate, or activating the power system may be inhibited or operation may be unstable:

- Strong radio waves are being transmitted by nearby equipment.
- You are carrying the keyless remote together with telecommunications equipment, laptop computers, mobile phones, or wireless devices.
- A metallic object is touching or covering the keyless remote.

▣ Low Keyless Remote Signal Strength

Communication between the keyless remote and the vehicle consumes the keyless remote's battery. Battery life is about two years, but this varies depending on regularity of use.

The battery is consumed whenever the keyless remote is receiving strong radio waves. Avoid placing it near electrical appliances such as televisions and personal computers.

It is possible to reduce battery consumption by turning off radio wave reception. When you hold down the lock and unlock buttons at the same time for approximately three seconds, the LED will blink twice and radio wave reception will turn off. If you press any button on the keyless remote once, it will begin receiving radio waves again.

Locking/Unlocking the Doors from the Outside

■ Using the Keyless Access System

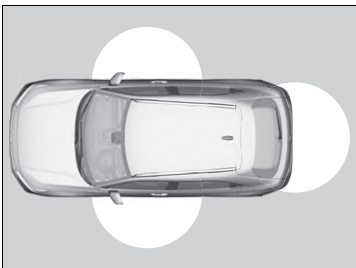

When you carry the keyless remote, you can lock/unlock the doors and tailgate. You can lock/unlock the doors and tailgate within a radius of about 80 cm (32 inches) of the outside door handle or tailgate outer handle.

▣ Locking/Unlocking the Doors from the Outside

If the interior light switch is in the door activated position, the interior light comes on when you unlock the doors and tailgate.

No doors opened: The light fades out after 30 seconds.

Doors and tailgate relocked: The light goes off immediately.

➤ **Interior Lights** P. 219

▣ Using the Keyless Access System

If you do not open a door or the tailgate within 30 seconds of unlocking the vehicle with the keyless access system, the doors and tailgate will automatically relock.

You can lock or unlock doors using the keyless access system only when the power mode is in VEHICLE OFF.

The keyless access system will not lock the vehicle when a door or the tailgate is open.

■ Locking the doors and tailgate

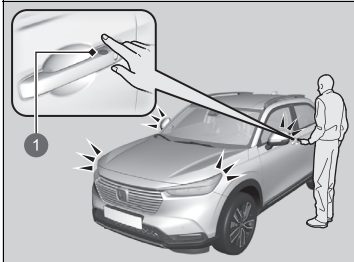

1 Door Lock Sensor

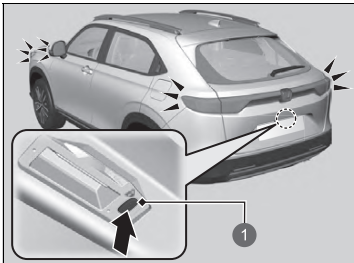

1 Lock Button

Touch the door lock sensor on the front door or press the lock button on the tailgate.

- ▶ Some exterior lights flash three times; all the doors and tailgate lock; and the security system sets.

☒ Using the Keyless Access System

- Do not leave the keyless remote in the vehicle when you get out. Carry it with you.
- Even if you are not carrying the keyless remote, you can lock/unlock the doors and the tailgate while someone else with the keyless remote is within range.
- The door may be unlocked if the door handle is covered with water in heavy rain or in a car wash if the keyless remote is within range.
- If you grip a front door handle or touch a door lock sensor wearing gloves, the door sensor may be slow to respond or may not respond by locking or unlocking the doors.
- After locking the door, you have up to 2 seconds during which you can pull the door handle to confirm whether the door is locked. If you need to unlock the door immediately after locking it, wait at least 2 seconds before gripping the handle, otherwise the door will not unlock.
- The door may not open if you pull it immediately after gripping the door handle. Grip the handle again and confirm that the door is unlocked before pulling the handle.
- Even within the 80 cm (32 inches) radius, you may not be able to lock/unlock the doors and the tailgate with the keyless remote if it is above or below the outside handle.
- The keyless remote may not operate if it is too close to the door, door glass and tailgate.

■ Unlocking the doors and tailgate

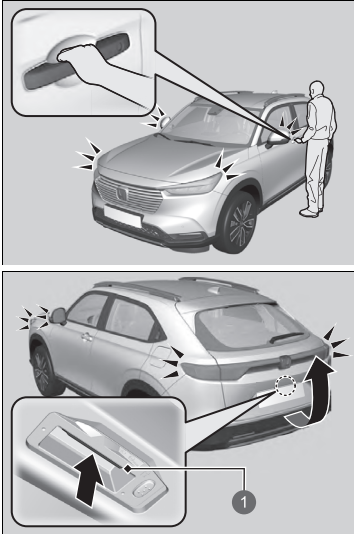

① Outer Handle

Grab the front door handle:

- ▶ All doors and tailgate unlock.
- ▶ Some exterior lights flash once.

Press the outer handle:

- ▶ The tailgate unlocks.
- ▶ Some exterior lights flash once.
- ▶ **Opening/Closing the Tailgate** P. 164

▶▶ Using the Keyless Access System

The light flash setting can be customized using the audio/information screen.

- ▶ **How to Customize the Vehicle Settings**
P. 311

Models with power tailgate

You can also unlock and open with the power tailgate.

- ▶ **Using the Tailgate Outer Handle** P. 170

■ Using the Remote Transmitter

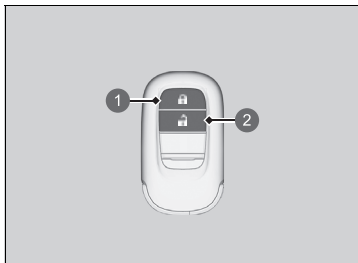

- ① Lock Button
- ② Unlock Button



■ Locking the doors and tailgate

Press the lock button.

- ▶ Some exterior lights flash three times, all the doors and tailgate lock, and the security system sets.

■ Unlocking the doors and tailgate

Press the unlock button.

- ▶ Some exterior lights flash once, and all doors and tailgate unlock.

⌘ Using the Remote Transmitter

If you do not open a door or the tailgate within 30 seconds of unlocking the vehicle with the remote transmitter, the doors and tailgate will automatically relock.

You can lock or unlock doors using the remote transmitter only when the power mode is in VEHICLE OFF.

Right-hand drive type

You cannot lock any doors from the outside when the keyless remote is inside the vehicle, and the beeper sounds. If you want to lock a door while the remote is still in the vehicle, do any of the following four times:

- Press the lock button on the keyless remote.
- Turn the key in the cylinder to lock.
- Touch the door lock sensor on the front door or press the lock button on the tailgate.

The remote transmitter uses low-power signals, so the operating range may vary depending on the surroundings.

The remote will not lock the vehicle when a door or the tailgate is open.

■ Locking/Unlocking the Doors Using a Key

If the lock or unlock button of the keyless remote does not work, use the key instead.



- ① Lock
- ② Unlock

Fully insert the key and turn it.

▶▶ Using the Remote Transmitter

If the distance at which the remote transmitter works varies, the battery is probably low.
If the LED does not come on when you press a button, the battery is dead.

▶▶ **Replacing the Remote Battery** P. 552

▶▶ Locking/Unlocking the Doors Using a Key

When you lock/unlock the driver's door with the key, all the other doors lock/unlock at the same time.

If you unlock a door with the built-in key while the security system is activated, the alarm will go off.

■ Locking a Door Without Using a Key

If you do not have the key on you, or if for some reason you cannot lock a door using the key, you can lock the door without it.

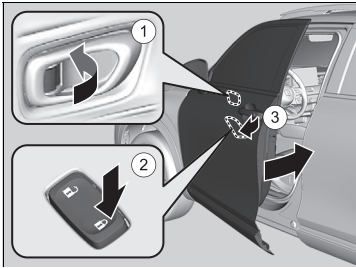

■ Locking the driver's door

Push the lock tab forward ① or push the master door lock switch in the lock direction ②, then pull and hold the outside door handle ③. Close the door, then release the handle.

■ Locking the passenger's doors

Push the lock tab forward and close the door.

■ Lockout prevention system

The doors and tailgate cannot be locked when the keyless remote is inside the vehicle.

☒ Locking a Door Without Using a Key

When you lock the driver's door, all the other doors and tailgate lock at the same time.

Before locking a door, make sure that the key is not inside the vehicle.

Locking/Unlocking the Doors from the Inside

■ Using the Lock Tab

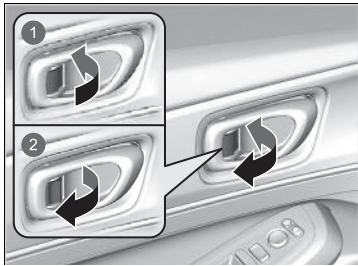

- 1 To lock
- 2 To unlock

■ **Locking a door**
Push the lock tab forward.

■ **Unlocking a door**
Pull the lock tab rearward.

☞ Using the Lock Tab

When you lock/unlock the door using the lock tab on the driver's door, all the other doors and the tailgate lock/unlock at the same time.

■ Unlocking Using the Front Door Inner Handle

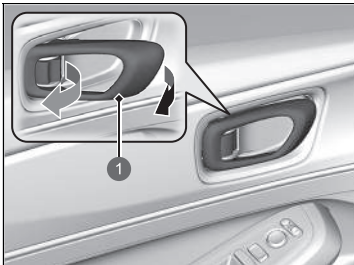

① Inner Handle

Pull the front door inner handle.

- ▶ The door unlocks and opens in one motion.

■ Using the Master Door Lock Switch

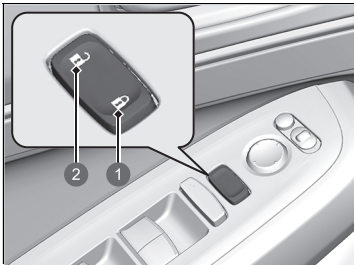

- ① To lock
- ② To unlock

Press the master door lock switch in as shown to lock or unlock all the doors and the tailgate.

☒ Unlocking Using the Front Door Inner Handle

The front door inner handles are designed to allow front seat occupants to open the door in one motion. However, this feature requires that front seat occupants never pull a front door inner handle while the vehicle is in motion.

Children should always ride in a rear seat where childproof door locks are provided.

☒ **Childproof Door Locks** P. 162

☒ Using the Master Door Lock Switch

When you lock/unlock the driver's door using the master door lock switch, all the other doors and the tailgate lock/unlock at the same time.

Childproof Door Locks

The childproof door locks prevent the rear doors from being opened from the inside regardless of the position of the lock tab.

■ Setting the Childproof Door Locks

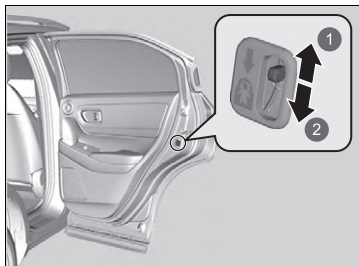

- ① Unlock
- ② Lock

Slide the lever in the rear door to the lock position, and close the door.

■ When opening the door

Open the door using the outside door handle.

☒ Childproof Door Locks

To open the door from the inside when the childproof door lock is on, put the lock tab in the unlock position, lower the rear window, put your hand out of the window, and pull the outside door handle.

Precautions for Opening/Closing the Tailgate

Always make sure individuals and objects are clear of the tailgate before opening or closing it.

Models without power tailgate

- Open the tailgate all the way.
 - ▶ If it is not fully opened, the tailgate may begin to close under its own weight.
- Be careful when it is windy. The wind may cause the tailgate to close.

All models

Keep the tailgate closed while driving to:

- ▶ Avoid possible damage.
- ▶ Prevent exhaust gas from leaking into the vehicle.
 - ➔ **Carbon Monoxide Gas** P. 98

Precautions for Opening/Closing the Tailgate

WARNING

Anyone caught in the path of a tailgate that is being opened or closed can be seriously injured.

Make sure that all people are clear of the tailgate before opening or closing it.

Be careful not to hit your head on the tailgate or to put your hands between the tailgate and the luggage area when closing the tailgate.

When you are storing or picking up luggage from the luggage area or by using a forward and back kicking motion under the centre of the rear bumper for hands free access*, while the engine is idling, do not stand in front of the exhaust pipe. You may get burned.

Do not allow any passenger in the luggage space. They may get hurt during hard braking, a sudden acceleration, or a crash.

* Not available on all models

Opening/Closing the Tailgate

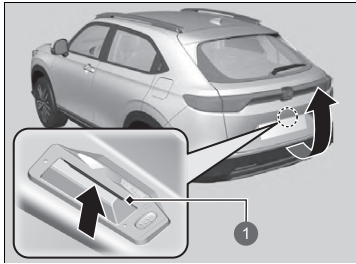

1 Outer Handle

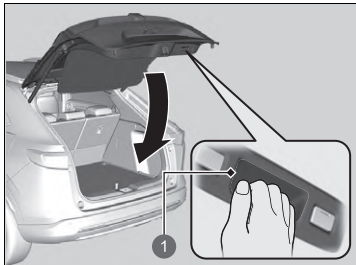

1 Inner Handle

When all the doors are unlocked or you press the tailgate unlock button* on the remote transmitter, the tailgate is unlocked. Press the tailgate outer handle and lift open the tailgate.

If you are carrying the keyless remote, you do not have to unlock the tailgate before opening it.

To close the tailgate, grab the inner handle, pull the tailgate down, and push it closed from outside.

ⓘ Precautions for Opening/Closing the Tailgate

Make sure luggage or other items do not touch the tailgate support struts.

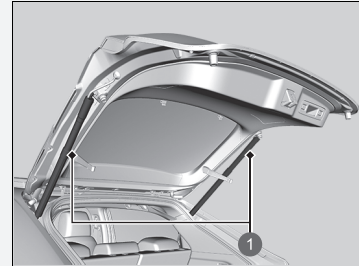

1 Tailgate Support Struts

ⓘ Opening/Closing the Tailgate

- Do not leave the keyless remote in the vehicle when you get out. Carry it with you.
- Even if you are not carrying the keyless remote, you can unlock the tailgate while someone else with the keyless remote is within range.

Opening/Closing the Power Tailgate*

The power tailgate can be operated by pressing the power tailgate button on the remote transmitter, pressing the power tailgate button in the driver's side control panel, pressing the outer handle or button on the tailgate, or by raising and lowering your foot under the centre of the rear bumper for hands free access.

The power tailgate can be opened/closed when the transmission is in **P**.

Opening/Closing the Power Tailgate*

⚠ WARNING

Opening or closing a power tailgate while any part of a passenger is in the tailgate's operating path can cause serious injury.

Make sure all passengers or objects are clear of the tailgate operating range before opening or closing the tailgate.

WARNING: Always take the ignition key with you whenever you leave the vehicle alone or with other occupants.

NOTICE

Do not push or pull on the power tailgate when it is being automatically opened or closed. Forcibly opening or closing the power tailgate while in operation can deform the tailgate frame.

When operating the power tailgate, make sure there is enough space around your vehicle. People near the tailgate may be seriously hurt if the tailgate hits or closes on their heads. Be especially cautious if children are around.

■ Using the Hands Free Access*

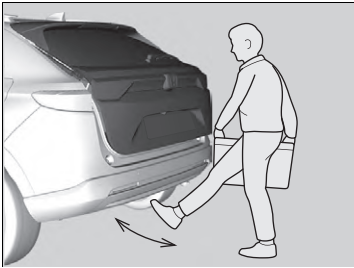

Use a forward and back kicking motion for about 1 second under the centre of the rear bumper to open or close the power tailgate while carrying the keyless remote.

- Some exterior lights will flash, then the tailgate begins to move.

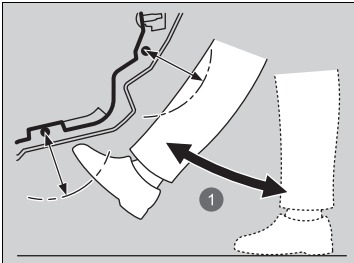

① About 1 second

▣ Using the Hands Free Access*

During rain or in other instances when the vehicle becomes wet, the sensor may not properly detect your foot motion.

When performing work on or around the rear section of the vehicle, you may inadvertently open or close the tailgate.

To prevent this from happening, select Customized Features on the audio/information screen and then select OFF for the feature.

► **How to Customize the Vehicle Settings**
P. 311

If you hold your foot under the bumper for too long or sweep your foot from side to side, the power tailgate does not open or close.

This function will not operate if you don't have the keyless remote on you. Please make sure you have the keyless remote on you.

■ Power Tailgate Walk Away Close

When you walk away from the vehicle while carrying the keyless remote, the power tailgate will automatically close.

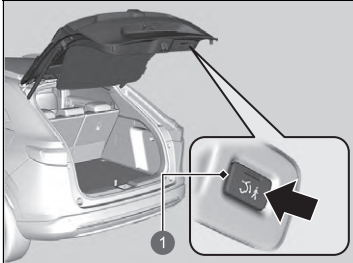

① Walk Away Close Button

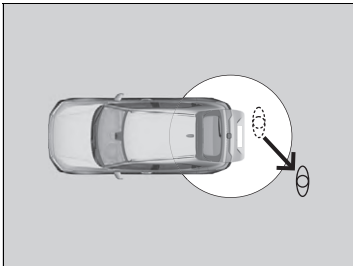

Walk at least 1.0 m (3 feet) away

1. Carry the keyless remote and press the walk away close button.
 - ▶ The indicator on the walk away close button will turn green when the walk away close is activated.

2. Walk at least 1.0 m (3 feet) away from the vehicle within 30 seconds of pressing the walk away close button.
 - ▶ Some exterior lights will flash then the power tailgate begins to close.

■ Using the Remote Transmitter

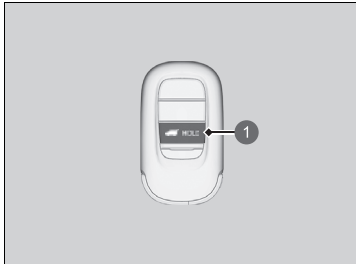

① Power Tailgate Button

Press the power tailgate button for more than one second to operate when the power mode is in VEHICLE OFF.

▶ Some exterior lights will flash.

If you press the button again while the power tailgate is moving, it will stop.

Press the button for more than one second, and the power tailgate will reverse direction.

■ Customizing when to open the tailgate

Anytime: The power tailgate unlocks and opens at the same time. This is the default setting.

When unlocked: The tailgate opens when all doors are unlocked.

➤ **How to Customize the Vehicle Settings** P. 311

⌘ Opening/Closing the Power Tailgate*

The power tailgate may not open or close under the following conditions:

- You activate the power system while the tailgate is automatically opening or closing.
- The vehicle is parked on a steep hill.
- The vehicle is swayed in a strong wind.
- The tailgate or the roof is covered with snow or ice.

If you replace the 12-volt battery or the power tailgate fuse while the tailgate is open, the power tailgate may be disabled. The power tailgate resumes once you manually close the tailgate.

Installing aftermarket components other than Honda genuine accessories on the power tailgate may prevent it from fully opening or closing.

Make sure the power tailgate is fully open before you get your luggage in and out.

The beeper sounds when you start driving while the power tailgate is still open, or closing.

■ Using the Power Tailgate Button

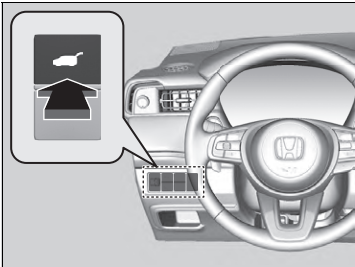

To open or close the power tailgate, press the power tailgate button for about one second.

▶ Some exterior lights will flash.

If you press the button again while the power tailgate is moving, it will stop. Press the button for about one second, and the power tailgate will reverse direction.

☒ Opening/Closing the Power Tailgate*

If the power tailgate meets resistance while opening or closing, the auto reverse feature reverses the direction. The beeper sounds three times.

The auto reverse function stops sensing when the tailgate is almost closed to make sure that it fully closes.

Do not touch the sensors located on both sides of the tailgate. The power tailgate does not close if you touch either sensor when you are trying to close the tailgate.

Be careful not to scratch the sensors with a sharp object. If scratched, they can be damaged, and the power tailgate closing feature malfunctions.

■ Using the Tailgate Outer Handle

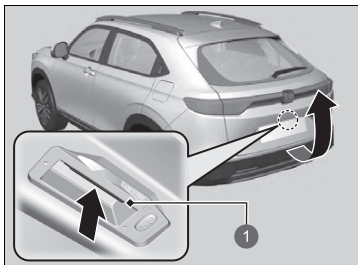

1 Outer Handle

If you press the outer handle of the tailgate for no longer than one second, the tailgate opens automatically.

- ▶ If you want to open the tailgate manually, press the outer handle for more than one second.

➤ **Opening/Closing the Tailgate** P. 164

If you are carrying the keyless remote, you do not have to unlock the tailgate before opening it.

If you press the outer handle again while the power tailgate is moving, it will stop. Press the outer handle, and the power tailgate will reverse direction.

▣ Using the Tailgate Outer Handle

- Do not leave the keyless remote in the vehicle when you get out. Carry it with you.
- Even if you are not carrying the keyless remote, you can unlock the tailgate while someone else with the keyless remote is within range.

You can change the power tailgate operation setting on and off.

➤ **How to Customize the Vehicle Settings**
P. 311

■ Using the Tailgate Inner Button

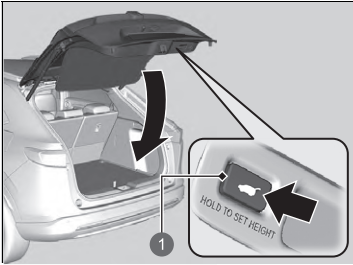

① Tailgate Inner Button

Press the tailgate inner button on the tailgate to close the power tailgate.

If you press the tailgate inner button again while the power tailgate is moving, it will stop. Press and release the tailgate inner button again, and the power tailgate will reverse direction.

■ Programming Tailgate Position

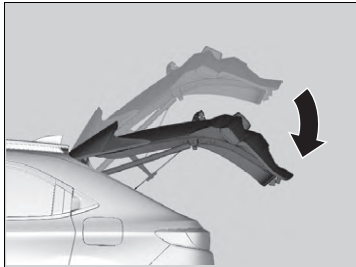

The extent to which the power tailgate automatically opens can be programmed.

To program:

1. Open the tailgate to the desired position.

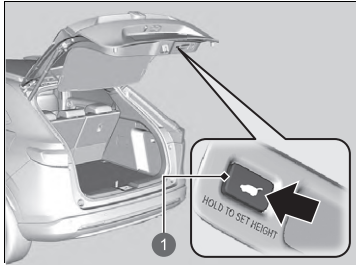

2. Press and hold the tailgate inner button.
You will hear one long beep, followed by two short beeps.

1 Tailgate Inner Button

▣ Programming Tailgate Position

If the tailgate is only slightly opened, the position cannot be programmed, even if you push the tailgate inner button.

If you want to reprogram the power tailgate to open all the way, manually raise the tailgate to its uppermost position and follow the directions step 2.

Auto-Closer

If you manually close the power tailgate, it latches automatically.

Power Tailgate Fall Detection

Automatically lowers the power tailgate when there is a possibility that the fully opened power tailgate can fall down by its own weight (for example, by snow on the tailgate). The beeper sounds while the power tailgate lowers.

Auto-Closer

The auto-closer feature does not activate if you push the tailgate outer handle while the power tailgate is closing.

NOTICE

Do not put any force on the tailgate while the power tailgate is latching.

Keep your hands away from the tailgate when you manually close the tailgate and let it latch automatically. It is dangerous to put your hands around the tailgate as it starts to latch itself.

Power Tailgate Fall Detection

If you try to manually close the power tailgate immediately after it fully opens, the power tailgate fall detection may activate.

Once the power tailgate fall detection activates, wait until the power tailgate fully closes. Keep away from the power tailgate when it is in motion.

If the power tailgate fall detection constantly activates, consult at a dealer.

Immobilizer System

This system prevents a key that has not been pre-registered from starting the power system.

Pay attention to the following when pressing the **POWER** button:

- Do not allow objects that emit strong radio waves near the **POWER** button.
- Make sure the key is not covered by or touching a metal object.
- Do not bring a key from another vehicle's immobilizer system near the **POWER** button.

Do not put the key near magnetic items. Electronic device, such as televisions and audio systems emit strong magnetic fields. Note that even a key chain can become magnetic.

Immobilizer System

NOTICE

Leaving the key in the vehicle can result in theft or accidental movement of the vehicle. Always take the key with you whenever you leave the vehicle unattended.

Do not alter the system or add other devices to it. Doing so may damage the system and make your vehicle inoperable.

If the system repeatedly does not recognise the coding of your key, contact a dealer. If you have lost your key and cannot start your vehicle, contact a dealer.

Right-hand drive type

Apply and hold the brake pedal before set the power mode to ON the first time after the 12-volt battery has been disconnected.

Security System Alarm

The security system alarm activates when the tailgate, bonnet, or doors are forcibly opened. The alarm does not activate if the tailgate or doors are opened with the remote transmitter or keyless access system.

■ When the security system alarm activates

The horn sounds intermittently and all the exterior lights flash.

■ To deactivate the security system alarm

Unlock the vehicle using the remote transmitter or keyless access system, or turn the power mode to ON. The system, along with the horn and flashing lights, is deactivated.

■ Setting the security system alarm

The security system alarm automatically sets when the following conditions have been met:

- The power mode is set to VEHICLE OFF.
- The bonnet is closed.
- All doors and the tailgate are locked from outside with the key, remote transmitter, or keyless access system.

■ When the security system alarm sets

The security system alarm indicator in the instrument panel blinks and the blinking interval changes after about 15 seconds.

■ To cancel the security system alarm

The security system alarm is cancelled when the vehicle is unlocked using the remote transmitter or keyless access system, or when the power mode is set to ON. The security system alarm indicator goes off at the same time.

▣ Security System Alarm

Do not alter the system or add other devices to it. Doing so may damage the system and make your vehicle inoperable.

The security system alarm will continue for approximately 5 minutes before the security system deactivates.

The system will go through ten 30-second cycles, during which the horn will sound and the security system alarm indicator will flash.

Depending on circumstances, the security system may continue operating for more than 5 minutes.

Do not set the security system alarm when someone is in the vehicle or a window is open. The system can accidentally activate when:

- Unlocking the door with the lock tab.
- Opening the bonnet with the bonnet release handle.

▣ Models with power tailgate

- Opening the tailgate with the power tailgate button on the dashboard.

If the 12-volt battery goes dead after you have set the security system alarm, the security alarm may go off once the 12-volt battery is recharged or replaced. If this occurs, deactivate the security system alarm by unlocking a door using the remote transmitter or keyless access system.

If you unlock a door with the built-in key while the security system is activated, the alarm will go off.

Super Locking*

The super locking function disables the lock tabs on all doors.

■ To activate the super locking function

- Turn the key in the driver's door towards the vehicle front twice within five seconds.
- Press the lock button on the remote transmitter twice within five seconds.
- Touch the door lock sensor on the door handle or press the lock button on the tailgate twice within five seconds.

■ To cancel the super locking function

Unlock the driver's door with the remote transmitter or keyless access system.

▶▶ Super Locking*

WARNING

No one must be inside the vehicle with the super locking set. Persons locked in can get seriously sick or die from the heat built inside the vehicle if left in the sun.

Make sure there is no one inside the vehicle before setting the super locking.

If you unlock a door with the built-in key while the security system is activated, the alarm will go off.

Opening/Closing the Power Windows

The power windows can be opened and closed when the power mode is in ON, using the switches on the doors.

The driver's side switches can be used to open and close all the windows. The power window lock button on the driver's side must be switched off (not pushed in, indicator off) to open and close the windows from anywhere other than the driver's seat.

When the power window lock button is pushed in, the indicator comes on and you can only operate the driver's window. Turn the power window lock button on if a child is in the vehicle.

Opening/Closing the Power Windows

WARNING

Closing a power window on someone's hands or fingers can cause serious injury.

Make sure your passengers are away from the windows before closing them.

WARNING: Always take the ignition key with you whenever you leave the vehicle alone or with other occupants.

The power windows can be operated for up to 10 minutes after you set the power mode to VEHICLE OFF.

Closing driver's door cancels this function.

Auto Reverse

If a power window senses resistance when closing automatically, it will stop closing and reverse direction.

The driver's window auto reverse function is disabled when you continuously pull up the switch.

The auto reverse function stops sensing when the window is almost closed to ensure that it fully closes.

■ Opening/Closing the Windows with Auto-Open/Close Function

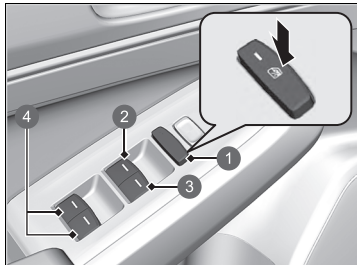

- ① Power Window Lock Button
- ② Driver's Window Switch
- ③ Front Passenger's Window Switch
- ④ Rear Passenger's Window Switch

■ Manual operation

To open: Push the switch down lightly, and hold it until the desired position is reached.

To close: Pull the switch up lightly, and hold it until the desired position is reached.

■ Automatic operation

To open: Push the switch down firmly.

To close: Pull the switch up firmly.

The window opens or closes completely. To stop the window at any time, push or pull the switch briefly.

■ Opening/Closing the Windows with the Remote

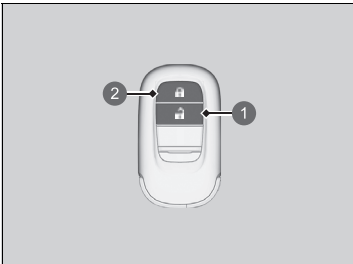

- ① Unlock Button
- ② Lock Button

To open: Press the unlock button, and then within 10 seconds, press it again and hold it.

To close: Press the lock button, and then within 10 seconds, press it again and hold it.

If the windows stop midway, repeat the procedure.

■ Closing the Windows with the Key



- ① Close

To close: Lock the driver's door with the key. Within 10 seconds of returning the key to the central position, turn the key in the lock direction and hold it there.

Release the key to stop the windows at the desired position. If you want further adjustment, repeat the same operation.

☒ Opening/Closing the Windows with the Remote

You can turn the remote window control function on and off.

- ☒ **How to Customize the Vehicle Settings**
P. 311

POWER Button

■ Changing the Power Mode

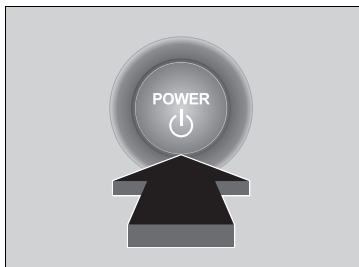

If you carry the keyless remote and press **POWER** button without depressing the brake pedal, the power mode will change in this order: VEHICLE OFF→ACCESSORY→ON→VEHICLE OFF.

VEHICLE OFF:

Vehicle power is turned OFF.

ACCESSORY:

The audio system and some accessories can be used.

ON:

All accessories can be used.

☒ POWER Button

If the keyless remote is set in a storage box or another place where its signal can be interrupted, the power mode may not change.

When the power mode is set to ON, the power mode will change to ACCESSORY if the **POWER** button is pressed while the transmission is in a position other than **P**.

■ Automatic Power Off

If you leave the vehicle for 30 to 60 minutes with the transmission in **P** and the power mode in ACCESSORY, the vehicle automatically goes into the mode similar to VEHICLE OFF (LOCK) to avoid draining the 12-volt battery.

When in this mode: The steering wheel does not lock. You cannot lock or unlock doors with the remote transmitter or the keyless access system. Press the **POWER** button twice to switch the mode to VEHICLE OFF (LOCK).

■ Power Mode Reminder

If you open the driver's door when the power mode is in ACCESSORY, a warning beep sounds.

■ Keyless Remote Reminder



When the power mode is set to any mode other than OFF and you remove the keyless remote from the vehicle and shut the door, an alarm will sound. If the alarm continues to sound, place the keyless remote in another location.

■ When the power mode is in ACCESSORY

The alarm will sound from outside the vehicle.

■ When the power mode is in ON

An alarm will sound both inside and outside the vehicle. In addition, a warning indicator will appear on the instrument panel.

⊠ Keyless Remote Reminder

When the keyless remote is within the system's operational range, and all the doors are closed, the warning function cancels.

If the keyless remote is taken out of the vehicle after the power system has been turned on, you can no longer change the **POWER** button mode or restart the power system. Always make sure if the keyless remote is in your vehicle when you operate the **POWER** button.

Removing the keyless remote from the vehicle through a window does not activate the warning buzzer.

Do not put the keyless remote on the dashboard or in the glove box. It may cause the warning buzzer to go off. Under some other conditions that can prevent the vehicle from locating the keyless remote, the warning buzzer may also go off even if the keyless remote is within the system's operational range.

Lights

■ Headlights/Position Lights

The lights will turn on automatically depending on the ambient brightness. They can also be switched on and off manually.

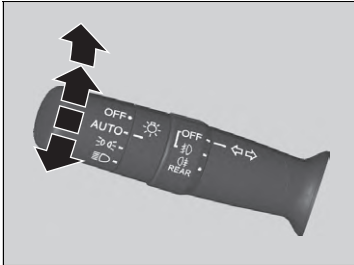

The exterior lights will switch on automatically when the light switch is set to **AUTO** while the power mode is in ON.

■ Manual operation

Headlights/position lights:

Turn the light switch to .

Position lights:

Turn the light switch to .

Headlight/position lights off:

Turn the light switch to **OFF** and release it while the transmission is in **P** and the parking brake is applied.

▶ The lights will come back on automatically when:

- The light switch is turned to **OFF** again and released.
- The transmission is changed out of **P** and the parking brake is released.



⌘ Lights

When the lights are on, the lights on indicator in the instrument panel will be on.

▶ **Lights On Indicator** P. 111

⌘ Headlights/Position Lights

When the position lights are on, the tail and rear licence plate lights will also switch on.

When the light switch is turned to  or  and the power is turned to OFF, a beeper sounds when the driver's door is opened.

When the light switch is turned to **AUTO** and the ambient light levels are low, the headlights and position lights will switch on if you unlock a door. They will switch off when the door is locked.

The light sensor is in the location shown below. Do not cover the light sensor.

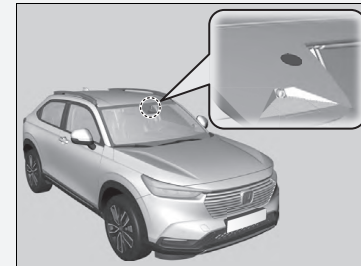

■ High Beams

When the headlights are on, push the lever forward. Pull the lever back to return to low beams.

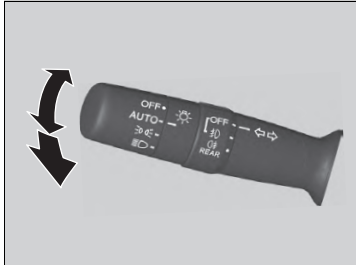

■ Flashing the high beams

Pull the lever back to switch on the high beams.

- ▶ Release the lever to return to low beams.

⊠ Headlights/Position Lights

Do not leave the lights on when the power system is off because it will cause the 12-volt battery to discharge.

■ Turn Signals

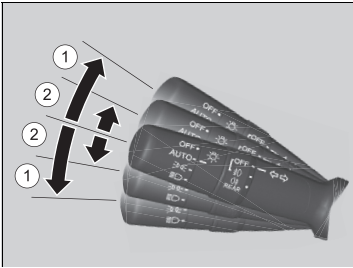

The turn signals can be used when the power mode is in ON.

■ ①: Turn signal

Push the lever up or down based on the direction you want to turn, and the turn signal will blink.

■ ②: One-touch turn signal

When you lightly push the lever up or down and release it, the turn signal will blink 3 times.

- ▶ If you lightly push the lever in the opposite direction while it is blinking, the blinking will stop.

☒ Turn Signals

The turn signal indicator on the instrument panel will blink when the external turn signal blinks.

☒ **Indicators** P. 102

■ Headlight Integration with Wipers

The headlights automatically come on when the wipers are used several times within a certain number of intervals with the headlight switch in **AUTO**.

The headlights automatically go off a few minutes later if the wipers are stopped.

■ Automatic Lighting Off Feature

The headlights, all other exterior lights, and the instrument panel lights turn off 15 seconds after you set the power mode to VEHICLE OFF, take the keyless remote with you, and close the driver's door.

However, when the switch is in , the position lights remain on.

If you set the power mode to VEHICLE OFF with the headlight switch on, but do not open the door, the lights turn off after 10 minutes (3 minutes, if the switch is in the **AUTO** position).

The lights turn on again when you unlock or open the driver's door. If you unlock the door, but do not open it within 15 seconds, the lights go off. If you open the driver's door, you will hear a reminder chime alerting you that the lights are on.

⌘ Headlight Integration with Wipers

This feature activates while the headlights are off in **AUTO**. The instrument panel brightness does not change when the headlights come on.

At dark ambient light levels, the automatic lighting control feature turns on the headlights, regardless of the number of wiper sweeps.

You can turn the headlight integration with wipers function on and off.

➤ **How to Customize the Vehicle Settings**
P. 311

⌘ Automatic Lighting Off Feature

You can change the headlight auto off timer setting.

➤ **How to Customize the Vehicle Settings**
P. 311

■ Fog Lights

The fog lights can be used when the power mode is in ON.

■ Front fog lights*

Can be used when the position lights or the headlights are on.

■ Rear fog light

Can be used when the headlights or the front fog lights* are on.

■ Front and rear fog light switch*

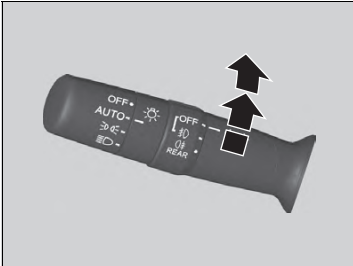

To turn the front fog lights on:

Rotate the switch up from the **OFF** position to the **FF** position. The **FF** indicator comes on.

To turn the front and rear fog lights on:

Rotate the switch one position up from the **FF** position. The **FF** and **REAR** indicators come on.

To turn the rear fog lights on:

Rotate the switch one position up from the **FF** position and then rotate the switch one position down from the **FF** position. The **REAR** indicator stays on.



To turn the rear fog light off, turn the headlight switch to the **OFF** position.

* Not available on all models

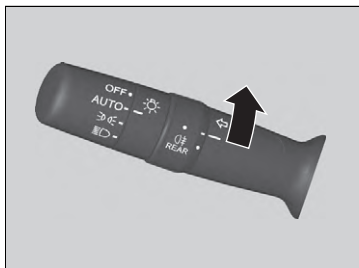
■ Rear fog light switch*



To turn the rear fog lights on:

Rotate the switch to . The  indicator comes on.

■ Daytime Running Lights

The daytime running lights come on when the following conditions have been met:

- The power mode is in ON.
- The headlight switch is **AUTO**.
- The ambient light is bright.

While the vehicle is stopped, if you turn the light switch to **OFF** and release it, the daytime running lights will turn off. When the transmission is changed out of **P** and the parking brake is released, the lights will come on again. Otherwise, if the light switch is once more turned to **OFF**, the lights will come on again.

☒ Daytime Running Lights

Daytime running lights and the position lights share the same light source.

Daytime running lights are brighter than the position lights.

The daytime running lights will not switch on if the position lights have been turned on manually.

Active Cornering Lights*

Enhance the visibility of the corner(s) when making a turn. With the power mode in ON, the headlights on, and the vehicle speed at less than 40 km/h (25 mph), the cornering light(s) comes on either when operating the turn signals or the steering wheel, or put the transmission into **R**.

■ **The corner you are making a turn towards is illuminated when:**

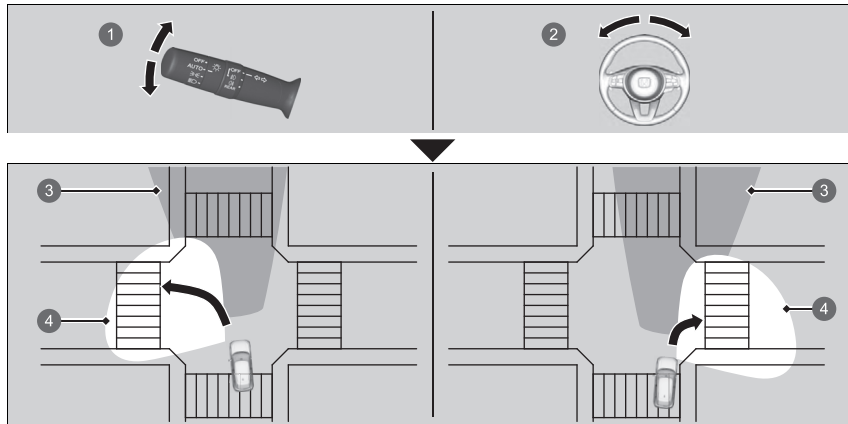

- 1 You operate the turn signal lever.
- 2 You turn the steering wheel around 70 degrees or more.
- 3 Headlight beam coverage
- 4 Cornering light beam coverage

▶▶ Active Cornering Lights*

The active cornering lights go off automatically after five minutes. To resume the lights on, recreate the same condition; putting the turn signal lever or steering wheel in the centre position, then operate it again, or if the transmission has been in **R**, move it to another position momentarily.

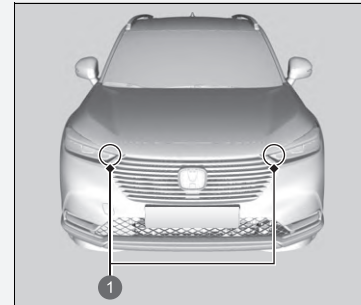

1 Active Cornering Lights

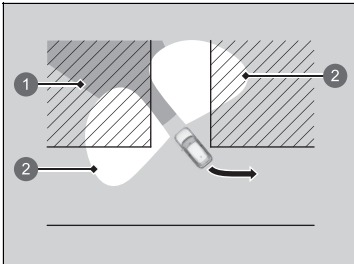

■ **Both front corners are illuminated when:**

You put the transmission into **R**.

- ① Headlight beam coverage
- ② Cornering light beam coverage

Headlight Adjuster*

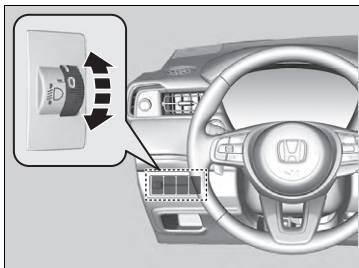

You can adjust the vertical angle of the low beam headlights when the power mode is in ON.

Turn the adjustment dial to select an appropriate angle for the headlights.

The larger dial number indicates the lower angle.

■ To select the adjusting dial position

Refer to the below table for the appropriate dial position for your vehicle's riding and loading conditions.

Condition	Dial position
A driver	0
A driver and a front passenger	0
Five persons in the front and rear seats	1
Five persons in the front and rear seats and luggage in the luggage area, within the limit of maximum permissible axle weight and maximum permissible vehicle weight	2
A driver and luggage in the luggage area, within the limits of maximum permissible axle weight and maximum permissible vehicle weight	3

ⓘ Headlight Adjuster*

The headlights are not suitable for both left and right hand drive and require adjustment or masking, as per UN-Regulation No.48 Dover Regulation.

➡ **Adjusting Headlight Distribution** P. 400

Models without headlight adjuster

Your vehicle is equipped with the automatic headlight adjusting system that automatically adjusts the vertical angle of the low beam headlights. If you find a significant change in the vertical angle of the headlights, there may be a problem with the system. Have your vehicle checked by a dealer.

Auto High-Beam

The front wide view camera detects the light sources ahead of the vehicle such as the lights of a preceding or oncoming vehicle, or street lights. When you are driving at night, the system automatically switches the headlights between low beam and high beam depending on the situation.

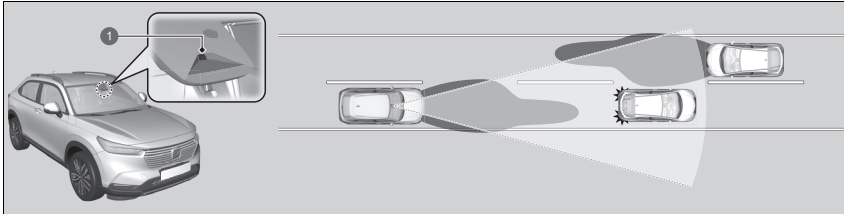

1 Front Wide View Camera

How to Use the Auto High-Beam

When all of the following conditions have been met, the auto high-beam indicator comes on and the auto high-beam is activated.

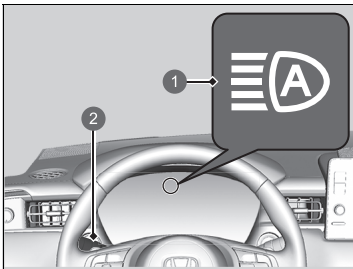

1 Auto High-Beam Indicator

2 Light Switch

- The power mode is in ON.
- The light switch is in **AUTO**.
- The lever is in the low beam position.
- The headlights have been automatically activated.
- It is dark outside the vehicle.

Auto High-Beam

The auto high-beam system does not always operate in every situation. This system is just for assisting the driver. Always observe your surroundings and switch the headlights between high beam and low beam manually if necessary.

The range and the distance at which the camera can recognise varies depending on conditions surrounding your vehicle.

Regarding the handling of the camera mounted to the inside of the windscreen, refer to the following.

➤ **Front Wide View Camera** P. 468

For the auto high-beam to work properly:

- Do not place an object that reflects light on the dashboard.
- Keep the windscreen around the camera clean.
- When cleaning the windscreen, be careful not to apply the windscreen cleanser to the camera lens.
- Do not attach an object, sticker or film to the area around the camera.
- Do not touch the camera lens.

If the camera receives a strong impact, or repairing of the area near the camera is required, consult a dealer.

If the auto high-beam indicator does not come on even when all the conditions have been met, carry out either of the procedures below and the indicator will come on.

- Pull the lever towards you and release it.
- Turn the light switch to  then turn the light switch to **AUTO**.

■ Automatic switching between high-beam and low-beam

When auto high-beam is active, the headlights switch between high beam and low beam based on the following conditions.

Switching to high beam:

All of the following conditions must be met before the high beams turn on.

- Your vehicle speed is 40 km/h (25 mph) or more.
- There are no preceding or oncoming vehicle with headlights or taillights turned on.
- There are few street lights on the road ahead.



Switching to low beam:

One of the following conditions must be met before the low beams turn on.

- Your vehicle speed is 24 km/h (15 mph) or less.
- There is a preceding or oncoming vehicle with headlights or taillights turned on.
- There are many street lights on the road ahead.

⚠ Automatic switching between high-beam and low-beam

In the following cases, the auto high-beam system may not switch the headlights properly or the switching timing may be changed. In case of the automatic switching operation does not fit for your driving habits, please switch the headlights manually.

- The brightness of the lights from the preceding or oncoming vehicle is intense or poor.
- Visibility is poor due to the weather (rain, snow, fog, windscreen frost, etc.).
- Surrounding light sources, such as street lights, electric billboards and traffic lights are illuminating the road ahead.
- The brightness level of the road ahead constantly changes.
- The road is bumpy or has many curves.
- A vehicle suddenly appears in front of you, or a vehicle in front of you is not in the preceding or oncoming direction.
- Your vehicle is tilted with a heavy load in the rear.
- A traffic sign, mirror, or other reflective object ahead is reflecting strong light towards the vehicle.
- The oncoming vehicle frequently disappears under roadside trees or behind median barriers.
- The preceding or oncoming vehicle is a motorcycle, bicycle, mobility scooter, or other small vehicle.

The auto high-beam system keeps the headlight low beam when:

- Windscreen wipers are operating at a high speed.
- The camera has been detected a dense fog.

■ Manual switching between high-beam and low-beam

If you want to manually switch the headlights between high beam and low beam, follow either of the procedures below. Note that when you do this, the auto high-beam indicator will turn off and the auto high-beam will be deactivated.

Using the lever:

Pull the lever towards you for flashing the high beams then release it or push the lever forward to the high beam position.

- ▶ To reactivate the auto high-beam, follow either of the procedures below and the auto high-beam indicator will come on.
- Pull the lever towards you and release it.
- Turn the light switch to  and then to **AUTO** when the lever is in the low beam position.

Using the light switch:

Turn the light switch to .

- ▶ To reactivate the auto high-beam, turn the light switch to **AUTO** when the lever is in the low beam position, the auto high-beam indicator will come on.

⌘ Auto High-Beam

You can change the auto high-beam system on and off.

▶ How to Customize the Vehicle Settings

P. 311

Wipers and Washers

■ Windscreen Wipers/Washers

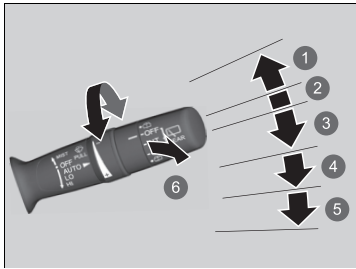

- ① **MIST**
- ② **OFF**
- ③ **AUTO**
- ④ **LO**: Low speed wipe
- ⑤ **HI**: High speed wipe
- ⑥ Washer

The windscreen wipers and washers can be used when the power mode is in ON.

■ **MIST**

The wipers run at high speed until you release the lever.

■ **Wiper switch (OFF, AUTO, LO, HI)**

Move the lever up or down to change the wiper settings.

■ **Washer**

Sprays while you pull the lever towards you. When you release the lever for more than one second, the spray stops, the wipers sweep two or three more times to clear the windscreen, then stop.

» Wipers and Washers

NOTICE

Do not use the wipers when the windscreen is dry. The windscreen will get scratched, or the rubber blades will get damaged.

The wiper motor may stop motor operation temporarily to prevent an overload. Wiper operation will return to normal within a few minutes, once the circuit has returned to normal.

NOTICE

Turn the washers off if no washer fluid comes out. The pump may get damaged.

NOTICE

In cold weather, the blades may freeze to the windscreen. Operating the wipers in this condition may damage the wipers. Use the demister or heated windscreen* to warm the windscreen, then turn the wipers on.

If the wipers stop operating due to an obstacle such as the buildup of snow, park the vehicle in a safe place. Rotate the wiper switch to **OFF**, and set the power mode to **ACCESSORY** or **VEHICLE OFF**, then remove the obstacle.

Automatic Intermittent Wipers

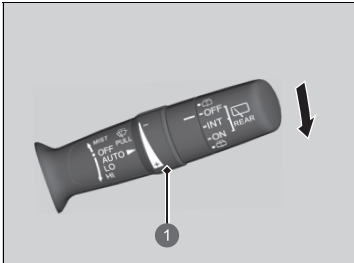

1 Adjustment Ring

When you push the lever down to **AUTO**, the windscreen wipers sweep once, and go into the automatic mode.

The wipers operate intermittently, at low speed, or at high speed and stop in accordance with the amount of rainfall the rainfall sensor detects.

AUTO sensitivity adjustment

When the wiper function is set to **AUTO**, you can adjust the sensitivity of the rainfall sensor (using the adjustment ring) so that wipers will operate in accordance with your preference.

Sensor sensitivity

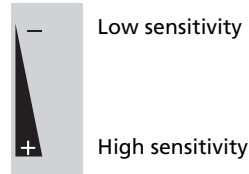

Automatic Intermittent Wipers

The rainfall sensor is in the location shown below.

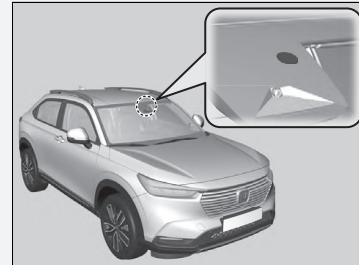

NOTICE

AUTO should always be turned **OFF** before the following situations in order to prevent severe damage to the wiper system:

- Cleaning the windscreen
- Driving through a car wash
- No rain present

■ Rear Wiper/Washer

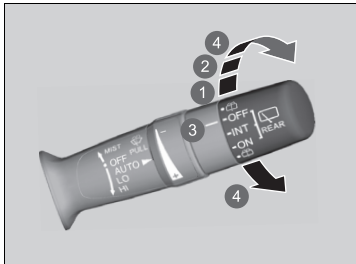

The rear wiper and washer can be used when the power mode is in ON.

■ Wiper switch (OFF, INT, ON)

Change the wiper switch setting according to the amount of rain.

■ Washer (☹)

Sprays while you rotate the switch to this position.

Hold it to activate the rear wiper and to spray the washer. Once released, the washer spray will stop and the rear wiper will return to its selected switch setting after a few sweeps.

- ① **INT**: Intermittent
- ② **ON**: Continuous wipe
- ③ **OFF**
- ④ Washer

■ Operating in reverse

When you put the transmission into **R** with the windscreen wipers activated, the rear wiper operates automatically as follows even if its switch is off.

Front Wiper Position	Rear Wiper Operation
AUTO (Intermittent)	Intermittent
LO (Low speed wipe) HI (High speed wipe)	Continuous

Rear Demister/Heated Door Mirror Button

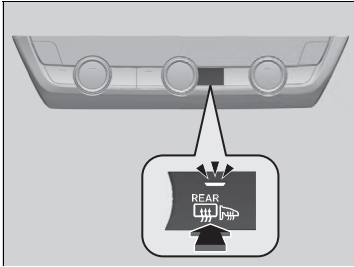

Press the rear demister and heated door mirror button to demist the rear window and mirrors when the power mode is in ON.

The rear demister and heated door mirror automatically switches off after 10-30 minutes depending on the outside temperature. However, if the outside temperature is 0°C or below, it does not automatically switch off.

⊠ Rear Demister/Heated Door Mirror Button

This system consumes a lot of power, so turn it off when the window has been demisted. Also, do not use the system for a long time while the power system is stopped. This may weaken the 12-volt battery, making it difficult to turn the power system on.

When the power mode is set to ON and the outside temperature is below 5°C, the heated door mirror may automatically activate for 10 minutes.

Heated Windscreen Button *

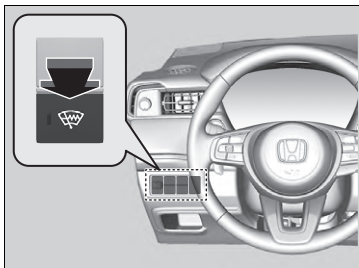

Press the heated windscreen button to deice the windscreen at the wiper park area and along the driver's side edge of the windscreen when the power mode is in ON. The heated windscreen will automatically switch off after 15 minutes.

⌘ Heated Windscreen Button *

This system consumes a lot of power, so turn it off when the window has been deiced. Also, do not use the system for a long period when the power system is stopped. This may weaken the 12-volt battery, making it difficult to turn the power system on.

Brightness Control

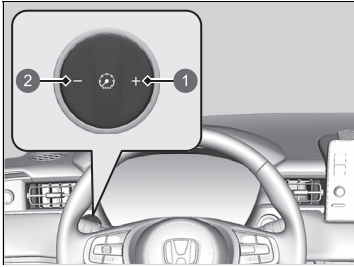

- ① + Button
- ② - Button

When the power mode is in ON, you can use the + or - button to adjust instrument panel brightness.

Brighten: Press the + button.

Dim: Press the - button.

Several seconds after adjusting the brightness, you will be returned to the previous screen.



■ Brightness level indicator

The brightness level is shown on the display while you are adjusting it.

☒ Brightness Control

The brightness of the instrument panel will be reduced when the following conditions have been met:

- The power mode is in ON.
- The position lights are turned on.
- The ambient lighting is low.

The brightness can be set differently for when the exterior lights are on, and when they are off.

Adjusting the Steering Wheel

The steering wheel height and distance from your body can be adjusted so that you can comfortably grip the steering wheel in an appropriate driving posture.

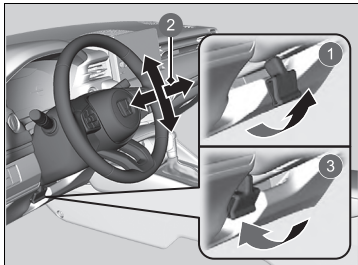

- 1 Release
- 2 Adjust
- 3 Lock

1. While the vehicle is stopped, pull the steering wheel adjustment lever up.
 - ▶ The steering wheel adjustment lever is under the steering column.
2. Move the steering wheel up or down, and in or out.
 - ▶ Make sure you can see the instrument panel gauges and indicators.
3. Push the steering wheel adjustment lever down to lock the steering wheel in position.
 - ▶ After adjusting the position, make sure you have securely locked the steering wheel in place by trying to move it up, down, in, and out.

Adjusting the Steering Wheel

⚠ WARNING

Adjusting the steering wheel position while driving may cause you to lose control of the vehicle and be seriously injured in a crash.

Adjust the steering wheel only when the vehicle is stopped.

Interior Rearview Mirror

Adjust the angle of the rearview mirror when you are sitting in the correct driving position.

Rearview Mirror with Day and Night Positions*

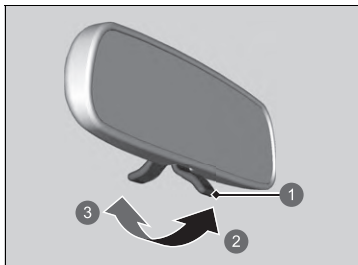

Flip the tab to switch the position. The night position will help to reduce the glare from headlights behind you when driving after dark.

- ① Tab
- ② Night Position
- ③ Daytime Position

Automatic Dimming Rearview Mirror*

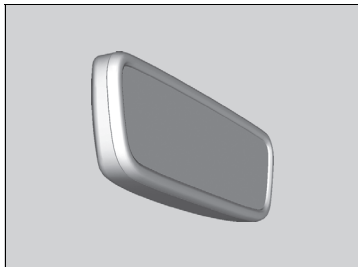

When you are driving after dark, the automatic dimming rearview mirror reduces the glare from headlights behind you, based on inputs from the mirror sensor. This feature is always active.

* Not available on all models

Mirrors

Keep the inside and outside mirrors clean and adjusted for best visibility.

Adjust the mirrors before you start driving.

➔ **Front Seats** P. 207

Automatic Dimming Rearview Mirror*

The auto dimming function cancels when the transmission is in **R**.

Power Door Mirrors

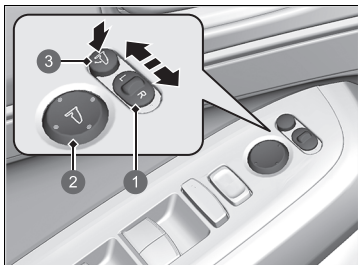

- 1 Selector Switch
- 2 Adjustment Switch
- 3 Folding Door Mirror Button

You can adjust the door mirrors when the power mode is in ON.

■ Mirror position adjustment

L/R selector switch: Select the left or right mirror. After adjusting the mirror, return the switch to the centre position.

Mirror position adjustment switch: Press the switch left, right, up, or down to move the mirror.

■ Folding door mirrors

Press the folding door mirror button to fold in and out the door mirrors.

■ Reverse Tilt Door Mirror*

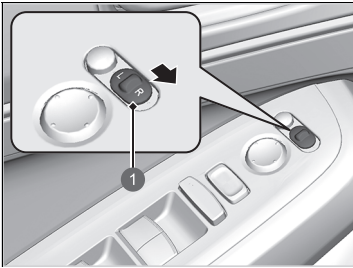

1 Selector Switch

If activated, the passenger side door mirror automatically tilts downward when you put the transmission into **R**; this improves close-in visibility on the passenger side of the vehicle when backing up. The mirror automatically returns to its original position when you take the transmission out of **R**.

To activate this feature, set the power mode to ON, and slide the selector switch to the passenger's side.

■ Automatic Folding Door Mirror Function*

■ Folding in the door mirrors

Press the lock button on the remote transmitter, or touch the door lock sensor on the front door.

- ▶ The mirrors start folding in automatically.

■ Folding out the door mirrors

Unlock all doors and the tailgate using the keyless remote or keyless access system. Open the driver's door.

- ▶ The mirrors start folding out automatically.

⌘ Automatic Folding Door Mirror Function*

You cannot turn the automatic folding out automatically if they have been folded in using the folding door mirror button.

You can turn the automatic folding door mirror function on and off.

⌘ How to Customize the Vehicle Settings

P. 311

Door mirrors will not fold automatically when locking from inside the vehicle using lock tab or master door lock switch.

Front Seats

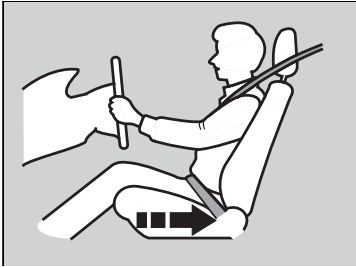

Move back to allow sufficient space.

Adjust the driver's seat as far back as possible while allowing you to maintain full control of the vehicle. You should be able to sit upright, well back in the seat and be able to adequately press the pedals without leaning forward, and grip the steering wheel comfortably. The passenger's seat should be adjusted in a similar manner, so that it is as far back from the front airbag in the dashboard as possible.

Seats

Always make seat adjustments before driving.

Front Seats

⚠ WARNING

Sitting too close to a front airbag can result in serious injury or death if the front airbags inflate.

Always sit as far back from the front airbags as possible while maintaining control of the vehicle.

In addition to the seat adjustment, you can adjust the steering wheel up and down, in and out. Allow at least 25 cm (10 inches) between the centre of the steering wheel and the chest.

■ Adjusting the Seat Positions

■ Adjusting the front manual seat

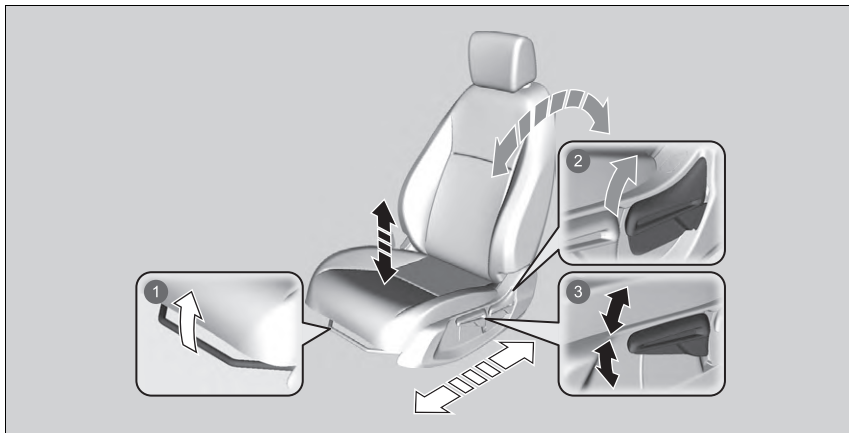

① Horizontal Position Adjustment

Pull up on the bar to move the seat, then release the bar.

② Seat-back Angle Adjustment

Pull up the lever to change the angle.

③ Height Adjustment (Driver's side only)

Pull up or push down the lever to raise or lower the seat.

► Adjusting the front manual seat

Once a seat is adjusted correctly, rock it back and forth to make sure it is locked in position.

■ Adjusting the Seat-Backs

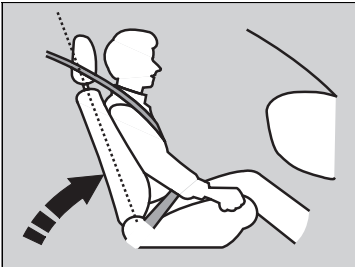

Adjust the driver's seat-back to a comfortable, upright position, leaving ample space between your chest and the airbag cover in the centre of the steering wheel.

The front seat passenger should also adjust their seat-back to a comfortable, upright position.

Reclining a seat-back so that the shoulder part of the belt no longer rests against the occupant's chest reduces the protective capability of the belt. It also increases the chance of sliding under the belt in a crash and being seriously injured. The farther a seat-back is reclined, the greater the risk of injury.

▣ Adjusting the Seat-Backs

⚠ WARNING

Reclining the seat-back too far can result in serious injury or death in a crash.

Adjust the seat-back to an upright position, and sit well back in the seat.

Do not put a cushion, or other object, between the seat-back and your back.

Doing so may interfere with proper seat belt or airbag operation.

If you cannot get far enough away from the steering wheel and still reach the controls, we recommend that you investigate whether some type of adaptive equipment may help.

Rear Seats

Folding Down the Rear Seats

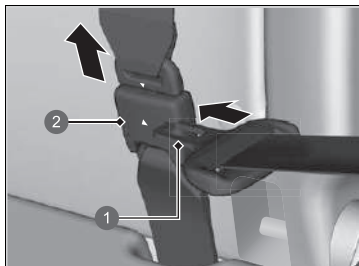

- 1 Latch Plate
- 2 Anchorage Buckle

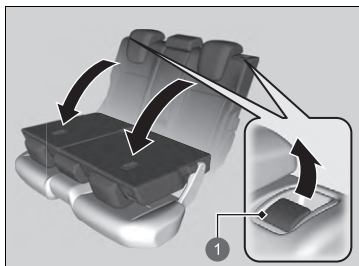

- 1 Release Lever

1. Store the centre seat belt first. Insert the latch plate into the slot on the side of the anchorage buckle.
2. Retract the seat belt into the holder on the ceiling.
 - ▣ **Seat Belt with Detachable Anchorage**
P. 53
3. Lower the rear seat head restraint to its lowest position.

4. Pull the release lever and fold down the seat.

Folding Down the Rear Seats

⚠ WARNING

Make sure the seat-backs are latched securely before driving.

The rear seat-backs can be folded down to accommodate bulkier items in the luggage area.

When returning the seat-back to its original position, push it firmly back. Also, make sure all rear shoulder belts are positioned in front of the seat-back.

Make sure all items in the luggage area or items extending through the opening into the rear seats are properly secured. Loose items can fly forward if you have to brake hard.

■ Folding Up the Rear Seat

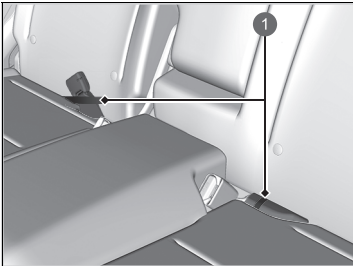

Separately lift up the left and right rear seat cushions to make room for luggage area.

■ Lifting up the seat cushion

1. Make sure the seat belt buckles are in their loops on the seat.

1 Loop

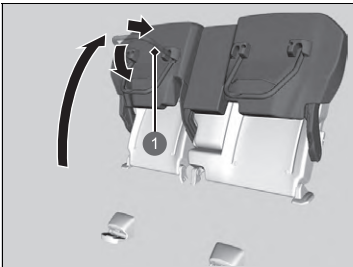

2. Pull up the rear seat cushion.
3. Fold the seat leg down while pushing the seat cushion firmly against the seat-back to lock it.

1 Seat Leg

▣ Folding Up the Rear Seat

After you fold the seat up, or put it back in the original position, make sure the seat is firmly secured by rocking it forward and back.

Check if there are any items on the seat before you pull the seat cushion up. Check if there are any obstacles around the floor guide before you put the seat-back in the original position.

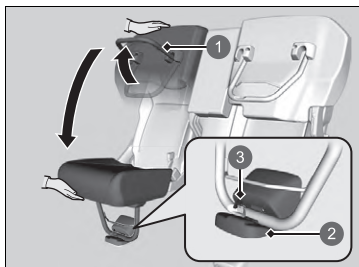

■ **Putting the seat in the original position**

1. Hold the seat cushion in place with one hand, then unlock it by pulling up the seat leg fully with your other hand.
 - Hold the seat cushion firmly, as it may abruptly fall when you unlock it.
2. Slowly lower the seat cushion, and set the seat leg in the floor guide until it latches in place.

- ① Seat Leg
- ② Floor Guide
- ③ Latch

Rear Seat Reminder

This feature alerts you to the possible presence of passengers or items in the rear seats before you exit the vehicle. It activates when the vehicle is set to VEHICLE OFF if the rear doors were opened shortly before or after the vehicle was set to ON.

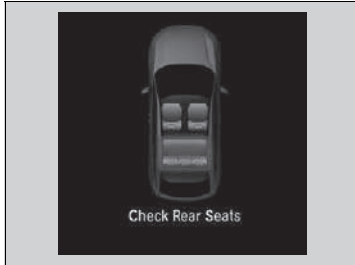

A reminder appears on the driver information interface and an alert will sound when the power mode is set to VEHICLE OFF.

⌘ Rear Seat Reminder

When the power mode is set to VEHICLE OFF, the reminder comes on briefly, then the function is deactivated.

The reminder will not work if the power mode has not been set to ON within 10 minutes of operating the rear doors.

The system does not detect passengers in the rear seats. Instead, it can detect when a rear door is opened and closed, indicating that there may be something in the rear seats.

You can turn off the notification setting.

🔍 How to Customize the Vehicle Settings

P. 311

Maintain a Proper Sitting Position

After all occupants have adjusted their seats and head restraints, and put on their seat belts, it is very important that they continue to sit upright, well back in their seats, with their feet on the floor, until the vehicle is safely parked and the power mode is off.

Sitting improperly can increase the chance of injury during a crash. For example, if an occupant slouches, lies down, turns sideways, sits forward, leans forward or sideways, or puts one or both feet up, the chance of injury during a crash is greatly increased.

In addition, an occupant who is out of position in the front seat can be seriously or fatally injured in a crash by striking interior parts of the vehicle or being struck by an inflating front airbag.

► Maintain a Proper Sitting Position

WARNING

Sitting improperly or out of position can result in serious injury or death in a crash.

Always sit upright, well back in the seat, with your feet on the floor.

Head Restraints

Your vehicle is equipped with head restraints in all seating positions.

■ Adjusting the Front Head Restraints

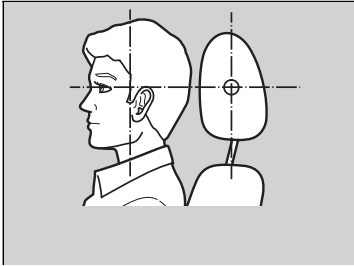

Position head in the centre of the head restraint.

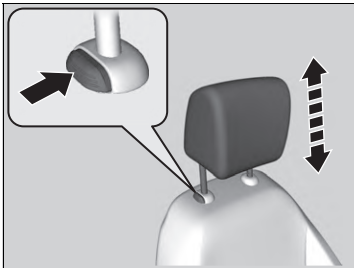

Head restraints are most effective for protection against whiplash and other rear-impact crash injuries when the centre of the back of the occupant's head rests against the centre of the restraint. The tops of the occupant's ears should be level with the centre height of the restraint.

To raise the head restraint:

Pull it upward.

To lower the head restraint:

Push it down while pressing the release button.

▶▶ Adjusting the Front Head Restraints

⚠ WARNING

Improperly positioning head restraints reduces their effectiveness and increases the likelihood of serious injury in a crash.

Make sure head restraints are in place and positioned properly before driving.

In order for the head restraint system to work properly:

- Do not hang any items on the head restraints, or from the restraint legs.
- Do not place any objects between an occupant and the seat-back.
- Install each restraint in its proper location.

■ Changing the Rear Seat Head Restraint Position

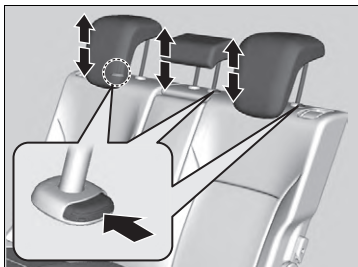

A passenger sitting in the rear seat seating position should adjust the height of their head restraint to an appropriate position before the vehicle begins moving.

To raise the head restraint:

Pull it upward.

To lower the head restraint:

Push it down while pressing the release button.

▣ Changing the Rear Seat Head Restraint Position

When you use the head restraint in the rear seating position, pull up the head restraint to its highest position. Do not use it in any lower position.



■ Removing and Reinstalling the Head Restraints

Head restraints can be removed for cleaning or repair.

To remove a head restraint:

Pull the restraint up as far as it will go. Then, push the release button and pull the restraint up and out.

To reinstall a head restraint:

Insert the legs back in place, then adjust the head restraint to an appropriate height while pressing the release button. Pull up on the restraint to make sure it is locked in position.

⌘ Removing and Reinstalling the Head Restraints

⚠ WARNING

Failure to reinstall, or correctly reinstall, the head restraints can result in severe injury during a crash.

Always replace the head restraints before driving.

Armrest

■ Using the Rear Seat Armrest



Pull down the armrest in the centre seat-back.

Interior Lights

Interior Light Switches

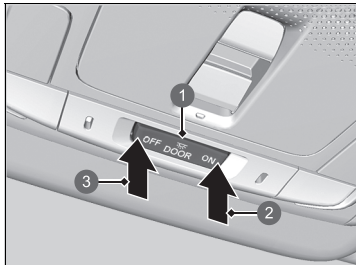

- 1 Door Activated Position
- 2 On
- 3 Off

ON

The interior lights come on regardless of whether the doors are open or closed.

Door activated

The interior lights come on in the following situations:

- When any doors are opened.
- You unlock the driver's door.
- When the power mode is set to VEHICLE OFF.

OFF

The interior lights remain off regardless of whether the doors are open or closed.

Interior Light Switches

In the door activated position, the interior lights fade out and go off about 30 seconds after the doors are closed.

The lights go off after about 30 seconds in the following situations:

- When you unlock the driver's door but do not open it.
- When you set the power mode to VEHICLE OFF but do not open a door.

You can change the interior lights dimming time.

How to Customize the Vehicle Settings

P. 311

The interior lights go off immediately in the following situations:

- When you lock the driver's door.
- When you close the driver's door in ACCESSORY mode.
- When you set the power mode to ON.

If you leave any of the doors open in VEHICLE OFF mode, the interior lights go off after about 15 minutes.

To avoid draining the 12-volt battery, do not leave the interior light on for an extended length of time when the power system is off.

■ Map Light Switches

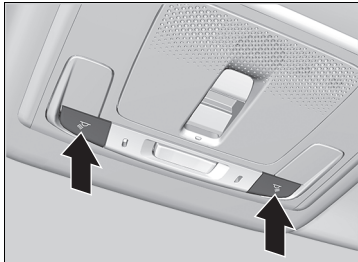

■ Front seat

The map lights can be turned on and off by pressing the buttons.

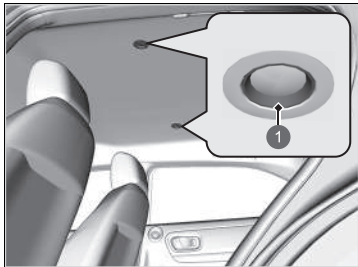

■ Rear seat

The map lights can be turned on and off by touching the map lights.

1 Touch

▣ Map Light Switches

When the front interior light switch is in the door activated position and any door is open, the map light will not go off when you press the buttons or touch the map lights.

■ Luggage Area Lights

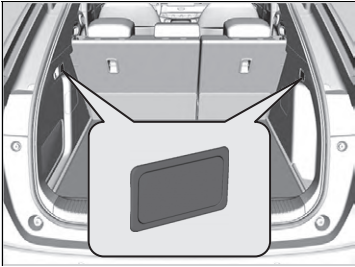

The luggage area lights come on when you open the tailgate.

Storage Items

■ Glove Box

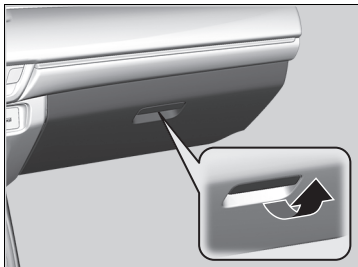

Pull the handle to open the glove box.

» Glove Box

⚠ WARNING

An open glove box can cause serious injury to your passenger in a crash, even if the passenger is wearing the seat belt.

Always keep the glove box closed while driving.

■ Console Box

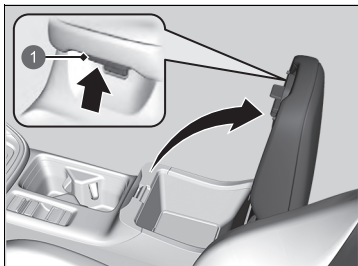

Pull the knob to open the console box.

① Knob

■ Beverage Holders

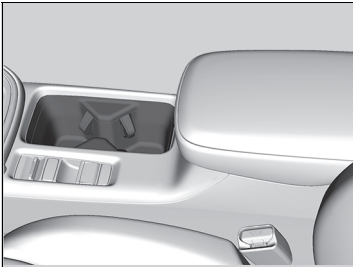

■ Front seat beverage holders

Are located in the console between the front seats.

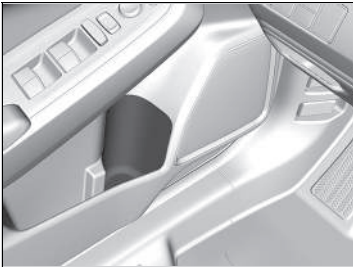

■ Front door side beverage holders

Are located on the both of front door side pockets.



■ Rear door side beverage holders

Are located on the both of rear door.

» Beverage Holders

NOTICE

Spilled liquids can damage the upholstery, carpeting, and electrical components in the interior.

Be careful when you are using the beverage holders. Hot liquid can scald you.



■ **Rear seat beverage holders**

Fold the armrest down to use the rear seat beverage holders.

■ **Coat Hooks**



There are coat hooks on the rear left and right grab handles.

☒ **Coat Hooks**

The coat hooks are not designed for large or heavy items.

■ Tie-down Anchorages

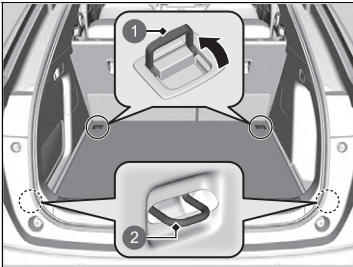

- ① Anchorages
- ② Anchorages*

The tie-down anchorages on the luggage area floor can be used to install a net for securing items.

■ Luggage Hook

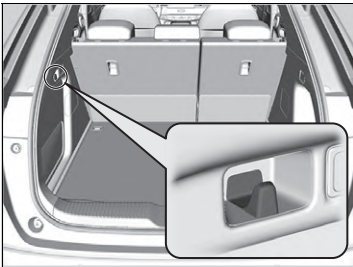

The luggage hook in the luggage area can be used to hang a light items.

▣ Tie-down Anchorages

Do not let anyone access items in the luggage area while driving. Loose items can cause injury if you have to brake hard.

▣ Luggage Hook

NOTICE

Do not hang a large object or an object that weighs more than 3 kg (6 lbs) on the side luggage hook. Hanging heavy or large objects may damage the hook.

* Not available on all models

■ Under-floor Storage Area

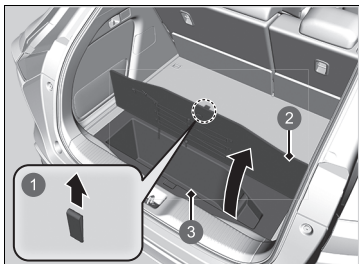

Pull the strap to open the luggage floor lid.

- 1 Strap
- 2 Luggage Floor Lid
- 3 Luggage Floor Box

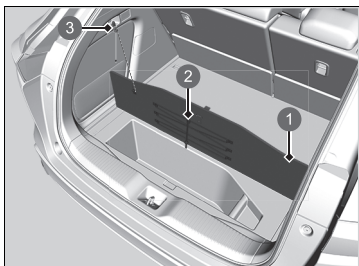

Models with Rubber Band

There is a rubber band on the back of the luggage floor lid. You can hang the string attached to the lid on the luggage hook and let it stand while carrying parcels in or out.

- 1 Luggage Floor Lid
- 2 Rubber Band
- 3 Luggage Hook

▣ Under-floor Storage Area

⚠ WARNING

Do not pull out or push in parcels while driving.

This may cause unforeseeable accident or injury at sudden braking.

Do not drive with the lid upright.

This may cause unforeseeable accident or injury at sudden braking.

■ Luggage Area Cover

The luggage area cover can be removed to give you more luggage room.

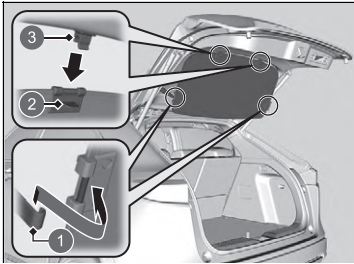

- 1 Hooks
- 2 Tab
- 3 Guide

■ To remove the luggage area cover

1. Open the tailgate.
2. Remove the luggage area cover from hooks on both sides.
3. Remove the cover from the guide while keeping the tab depressed.

Reverse this procedure to install the luggage area cover.

After reinstalling the luggage area cover, make sure it is latched securely.

■ To store the luggage area cover

1. Hold the corner near the tag on the cover.

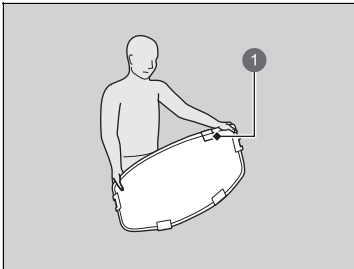

- 1 Tag

▣ Luggage Area Cover

Do not place items on the luggage area cover, or stack objects higher than the top of the back seat. They could block your view and be thrown around the vehicle during a crush or sudden stop.

When removing the luggage area cover, hold it firmly with your hands as it may open vigorously. Carefully check the surrounds and slowly open the cover while holding it firmly with both hands.

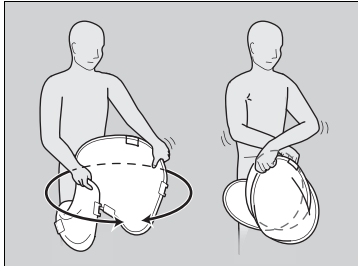

2. Hold both corners of the luggage area cover with your arms crossed one on the other and fold the cover.

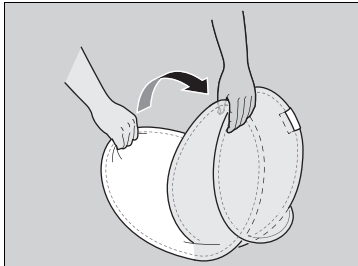

3. Bring both circular halves together in perfect alignment.

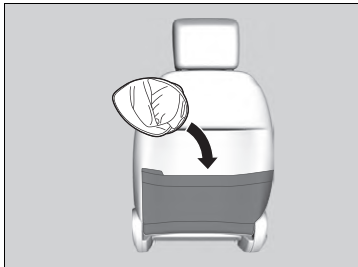

4. Store the luggage area cover in the back pocket of the front seat while keeping it firmly pushed by hand.

Other Interior Convenience Items

■ Sun Visor

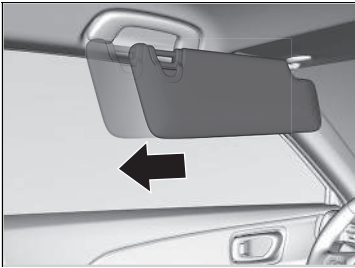

The sun visor can be extended horizontally.

■ Accessory Power Socket

The accessory power socket can be used when the power mode must be in ACCESSORY or ON.



■ Console panel

Open the cover to use it.

» Accessory Power Socket

NOTICE

Do not insert an automotive type cigarette lighter element. This can overheat the accessory power socket.

The accessory power socket is designed to supply power for 12-volt DC accessories that are rated 180 watts (15 amps) or less.

To prevent 12-volt battery drain, only use the accessory power socket with the power system on.

When the accessory power socket is not in use, close the cover to prevent any small foreign objects from getting into the accessory power socket.

■ Wireless Charger*

To use the wireless charger, the power mode must be in ACCESSORY or ON. Charge any devices compatible with Qi wireless charging on the area indicated by the  mark as follows:

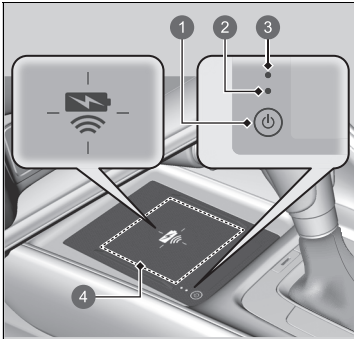

- ①  (Power) Button
- ② Green Indicator
- ③ Amber Indicator
- ④ Charging Area

1. To turn the system on and off, press and hold the  (power) button.
 - ▶ When the system is activated, the green indicator light comes on.
2. Place the device you want to charge on the charging area.
 - ▶ The system will automatically start charging the device, and the amber indicator light will come on.
 - ▶ Make sure that the device is compatible with the system, and placed with the chargeable side in the centre of the charging area.
3. When charging is completed, the green indicator light will come on.
 - ▶ Depending on the device, the amber indicator light will stay on.

▶▶ Wireless Charger*

⚠ WARNING

Metal objects between the charge pad and the device to be charged will get hot and can burn you.

- Always remove foreign objects from the charge pad before charging the device.
- Be sure the surface is clear of dust and other debris before charging.
- Do not spill liquids (i. e. water, drinks, etc.) on the charger and the device.
- Do not use oil, grease, alcohol, benzene or thinner for cleaning the charge pad.
- Do not cover the system with towels, clothing, or other objects while charging etc.
- Avoid spraying aerosols which may come in contact with the charge pad surface.

This system consumes a lot of power. Do not use the system for a long time when the power system is off. This may weaken the 12-volt battery, making it difficult to turn the power system on.

When using the wireless charger, check the user's manual that came with the compatible device you want to charge.

 appears on the audio/information screen when the device is being charged by the wireless charger.

■ When charging does not start

Perform one of the solutions in the following table.

Indicator		Cause	Solution
Green & Amber	Blinking simultaneously	There is an obstacle(s) between the charging area and the device.	Remove the obstacle(s).
		The device is not within the charging area.	Pick up and reset the device to the centre of the charging area where  is located.
		The temperature of the wireless charger pad increases.	Temporarily suspend charging the device. Wait for the temperature to drop and attempt to charge the device again.
Amber	Blinking	The wireless charger is faulty.	Contact a dealer for repairs.

Controls

▶▶ Wireless Charger*

The wireless charger can support up to 15W, but the charging rate varies based on the device and other conditions.

NOTICE

Do not place any magnetic recording media or precision machines within the charge area while charging.

The data on your cards such as credit cards can be lost because of the magnetic effect. Also, precision machines such as watches can be affected.

“Qi” and  marks are the registered trademarks owned by Wireless Power Consortium (WPC).

In the following cases, charging may stop or not start:

- The device is already fully charged.
- The temperature of the device is extremely high while charging.
- You are at a place that emits strong electromagnetic waves or noises, such as TV station, electric power plant, or petrol station.
- The device has a cover, case or accessories which are not compatible with wireless charging.

A device may not charge if the size or shape of its chargeable side is not appropriate for use with the charging area.

Not all devices are compatible with the system.

During the charging phase, it is normal for the charging area and the device to heat up.

Wireless Charger*

Charging may be briefly interrupted when:

- All doors or the tailgate are closed
- to avoid interference with the proper functioning of the keyless access system.
- The position of the device is altered.

Do not charge more than one device at a time on a charging area.

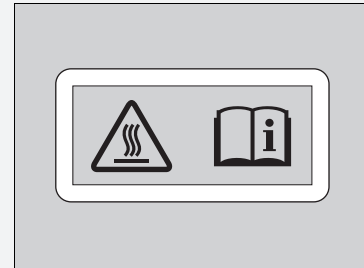

Burn risk:

Any metal objects placed between pad and device may become hot.

If the device becomes too hot and its battery protection function activates, it may charge extremely slowly or no longer charge. The temperature at which the battery protection function activates depends on the device.

* Not available on all models

■ Heated Steering Wheel*

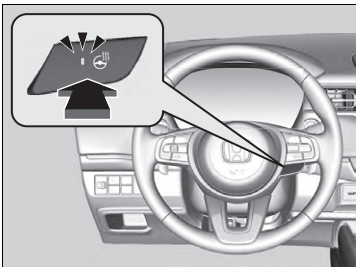

The heated steering wheel can be used when the power mode is in ON.

Press the button on the right side of the steering wheel.

When a comfortable temperature is reached, press the button again to turn it off.

The heated steering wheel is turned off every time you turn the power system on, even if you turned it on the last time you drove the vehicle.

☒ Heated Steering Wheel*

Do not use the heated steering wheel continuously when the power system is off. Under such conditions, the 12-volt battery may be weakened, making it difficult to turn the power system on.

Front Seat Heaters



The seat heaters can be used when the power mode is in ON.

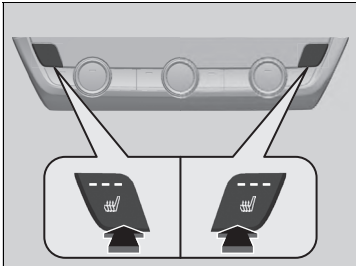

Press the seat heater button:

- Once - The HI setting (three indicators on)
- Twice - The MID setting (two indicators on)
- Three times - The LO setting (one indicator on)
- Four times - The OFF setting (no indicators on)

When the power mode is turned on after it is turned off, the previous setting is maintained.

Front Seat Heaters

⚠ WARNING

Heat induced burns are possible when using seat heaters.

Persons with a diminished ability to sense temperature (e.g., persons with diabetes, lowerlimb nerve damage, or paralysis) or with sensitive skin should not use seat heaters.

Do not use the seat heaters even in LO when the power system is off. Under such conditions, the 12-volt battery may be weakened, making the power system difficult to start.

After a certain period of time, the strength setting for the seat heater will automatically be reduced by one level at a time until the seat heater shuts off. The elapsed time varies according to the interior environment.

Using Automatic Climate Control





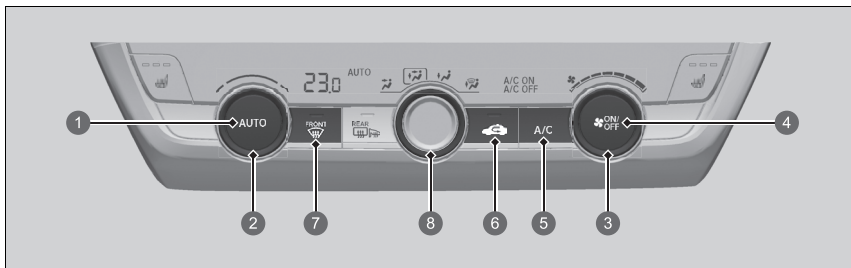

The automatic climate control system maintains the interior temperature you select. The system also selects the proper mix of heated or cooled air that raises or lowers the interior temperature to your preference as quickly as possible.

Use the system when the power system is on.

1. Press the **AUTO** button.
2. Adjust the interior temperature using the temperature control dial.
3. Press the **ON/OFF** (on/off) button to cancel.

Models without SYNC button



- 1 **AUTO** Button*¹
- 2 Temperature Control Dial*¹
- 3 Fan Control Dial*¹
- 4 **ON/OFF** Button*¹
- 5 **A/C** (Air Conditioning) Button*¹
- 6  (Recirculation) Button*¹
- 7  (Windscreen Demister) Button*¹
- 8 **MODE** Control Dial
 -  Air flows from dashboard vents
 -  Air flows from dashboard and floor vents
 -  Air flows from floor vents
 -  Air flows from floor and windscreen demister vents

*1: Left-hand drive types shown. For the right-hand drive types, these buttons are located at the symmetrically opposite to the left-hand drive type.

Using Automatic Climate Control

If any buttons are pressed while using the climate control system in auto, the function of the button that was pressed will take priority.

The **AUTO** indicator will go off, but functions unrelated to the button that were pressed will be controlled automatically.

To prevent cold air from blowing in from outside, the fan may not start immediately when the **AUTO** button is pressed.

If the interior is very warm, you can cool it down more rapidly by partially opening the windows, turning the system on auto, and setting the temperature to low. Change the fresh mode to recirculation mode until the temperature cools down.

When you set the temperature to the lower or upper limit, **Lo** or **Hi** is displayed.





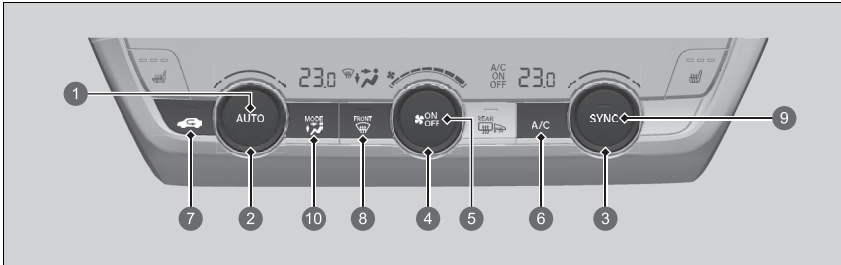

Pressing the **ON/OFF** button switches the climate control system between on and off. When turned on, the system returns to your last selection.

While ECON mode is active, the climate control system may have reduced cooling performance.

The High Voltage battery level being low may reduce the climate control system performance.

Models with SYNC button



- ① **AUTO** Button*¹
- ② Driver's Side Temperature Control Dial*¹
- ③ Passenger's Side Temperature Control Dial*¹
- ④ Fan Control Dial*¹
- ⑤ **ON/OFF** Button
- ⑥ **A/C** (Air Conditioning) Button*¹
- ⑦  (Recirculation) Button*¹
- ⑧  (Windscreen Demister) Button*¹
- ⑨ **SYNC** (Synchronization) Button*¹
- ⑩ **MODE** Control Button*¹
 -  Air flows from dashboard vents
 -  Air flows from dashboard and floor vents
 -  Air flows from floor vents
 -  Air flows from floor and windscreen demister vents

*1: Left-hand drive types shown. For the right-hand drive types, these buttons are located at the symmetrically opposite to the left-hand drive type.

■ Switching between the recirculation and fresh air modes

Press the  (recirculation) button and switch the mode depending on environmental conditions.

Recirculation mode (indicator on): Recirculates air from the vehicle's interior through the system.

Fresh air mode (indicator off): Maintains outside ventilation. Keep the system in fresh air mode in normal situations.

Defrosting the Windscreen and Windows

Models without SYNC button

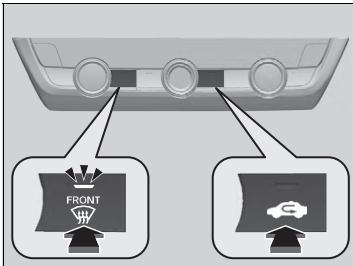

Pressing the  button turns the air conditioning system on and automatically switches the system to fresh air mode.

Press the  button again to turn off, the system returns to the previous settings.

Models with SYNC button

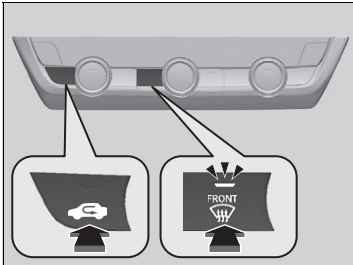

Defrosting the Windscreen and Windows

For your safety, make sure you have a clear view through all the windows before driving.

Do not set the temperature near the upper or lower limit.

When cold air hits the windscreen, the outside of the windscreen may fog up.

■ To rapidly defrost the windows

Models without SYNC button

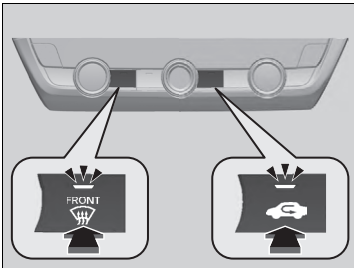

1. Press the  button.
2. Press the  button (indicator on).

Models with SYNC button

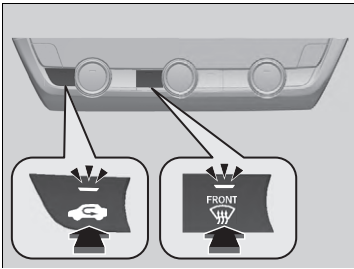

►► To rapidly defrost the windows

After defrosting the windows, switch over to fresh air mode. If you keep the system in recirculation mode, the windows may fog up from humidity. This impedes visibility.

■ Synchronization Mode*

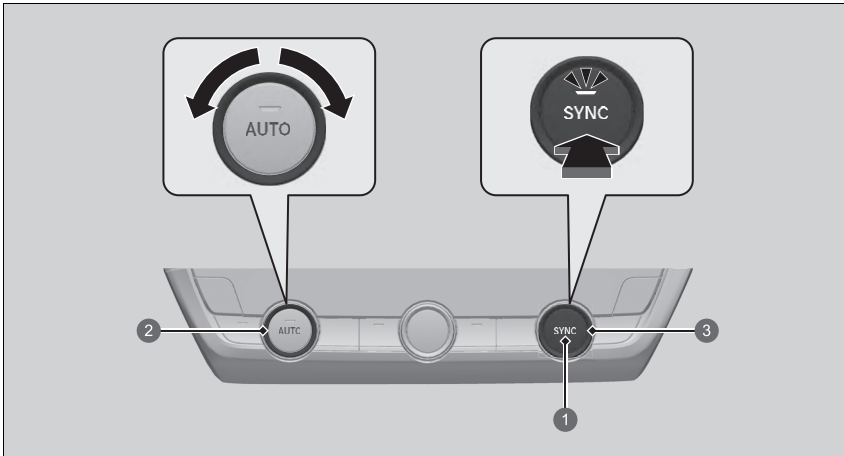

- 1 **SYNC** button
- 2 Driver's Side Temperature Control Dial
- 3 Passenger's Side Temperature Control Dial

You can set the temperature synchronously for the driver's side and the passenger's side in synchronization mode.

1. Press the **SYNC** button.
 - The system switches to synchronization mode.
2. Adjust the temperature using the driver's side temperature control dial.

Press the **SYNC** button to return to dual mode.

* Not available on all models

Continued

▣ Synchronization Mode*

When you press the  button, the system changes to synchronization mode.

When the system is in synchronization mode, the driver's side temperature and the passenger's side temperature can not be set separately.

■ Selecting the Desired Air Outlet

You can select the desired air outlet by turning the dial to the respective position.

 selects outlet **2**.

 selects outlet **3**.

 selects blockage of both **2** and **3**.

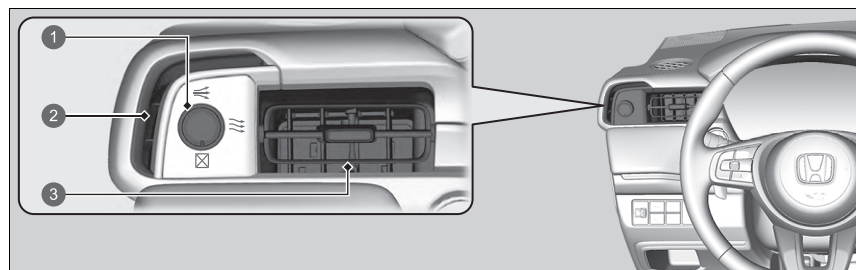

1 Dial

2 Air Outlet

3 Air Outlet

Automatic Climate Control Sensors

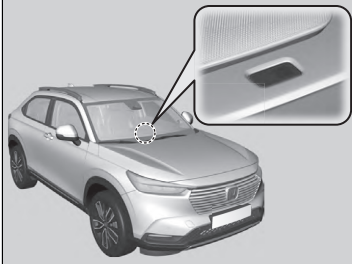

The automatic climate control system is equipped with sensors. Do not cover or spill any liquid on them.

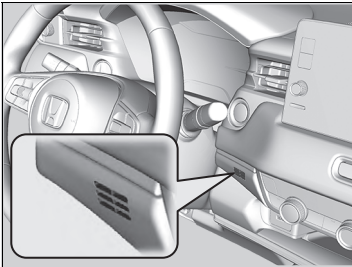

Features

This chapter describes how to operate technology features.

Audio System	246
Display Audio	248
Audio Error Messages	337
General Information on the Audio System	338
Emergency Call (eCall)	344
Refuel Recommend	349

About Your Audio System

The audio system features FM/AM radio and Digital Audio Broadcasting (DAB) service. It can also play USB flash drives, iPod, iPhone, *Bluetooth*® devices, and smartphone.

You can operate the audio system from the buttons and knobs on the panel, the remote controls on the steering wheel or the icons on the touchscreen interface.

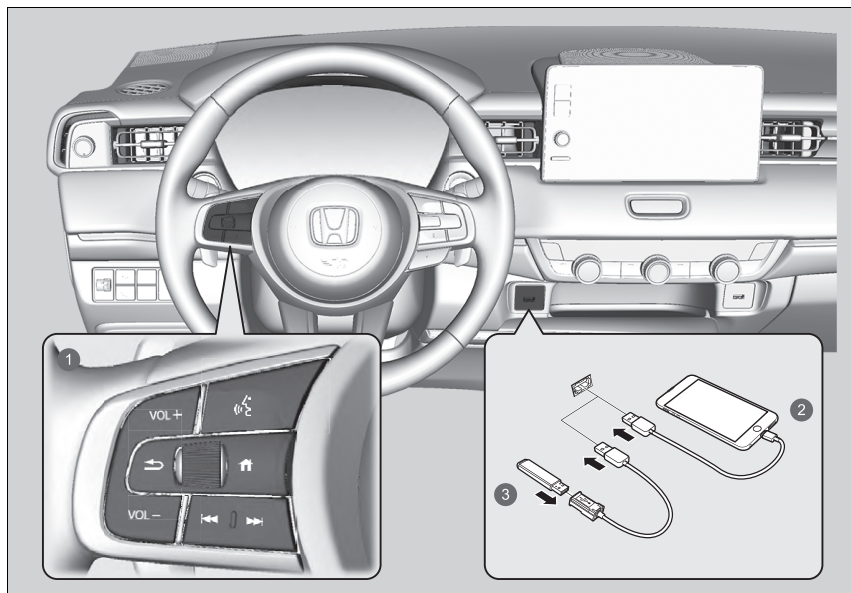

- 1 Remote Controls
- 2 iPod
- 3 USB Flash Drive

About Your Audio System

iPod®, iPhone® and iTunes® are trademarks of Apple Inc.

Audio System Theft Protection

The audio system is disabled when it is disconnected from the power source, such as when the 12-volt battery is disconnected or goes dead. In certain conditions, the system may display a code entry screen. If this occurs, reactivate the audio system.

■ Reactivating the audio system

1. Set the power mode to ON.
2. Turn on the audio system.
3. Press and hold the audio system power button for more than two seconds.
 - ▶ The audio system is reactivated when the audio control unit establishes a connection with the vehicle control unit. If the control unit fails to recognise the audio unit, you must go to a dealer and have the audio unit checked.

Start Up

The Display Audio starts automatically when you set the power mode to ACCESSORY or ON. At start-up, the following screen about the data upload will be displayed.

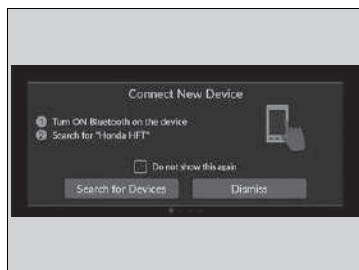
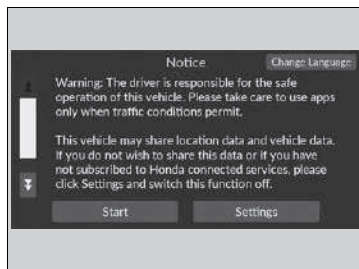

Select **Start**.

- ▶ If you want to change the settings for data upload, select **Settings**, then select the ON/OFF settings on the **Location and vehicle data sharing** screen.
- ▶ If you do not select **Start**, the system will automatically be switched the home screen after a certain period of time.
- ▶ If there is no registered device, select **Start** and the *Bluetooth*® pairing screen will be displayed.

■ To pair a mobile phone (when there is no phone paired to the system)

1. Make sure your phone is in search or discoverable mode.
2. Select **Honda HFT** from your phone.
 - ▶ If you want to pair a phone from this Display Audio, select **Search for Devices**, and then select your phone when it appears on the list.
 - ▶ If you check the box with **Do not show this again**, this screen will not be displayed.

Start Up

Location and vehicle data sharing

ON: Available the data communication.

OFF: Not available the data communication.

Basic Operation

Audio System Function

To use the audio system function, the power mode must be in ACCESSORY or ON.



- | | |
|---|---|
| <ul style="list-style-type: none"> 1 All Apps 2 Status Icons 3 App Shortcut Icons 4 Arrow 5 Display Mode Icon | <ul style="list-style-type: none"> 6 Mode Change Switch Icons 7 (Seek/Skip) Buttons 8 VOL/ AUDIO (Volume/Power) Knob 9 (Back) Button 10 (Home) Button |
|---|---|

Audio System Function

This screen is shown for the left-hand drive models. For the right-hand drive models, these are located at the symmetrically opposite to the left-hand drive model.

 **All Apps:** Displays the all apps.

Status Icons: Show the indicators of the information for the vehicle, connected phones, etc. in the header area.

App Shortcut Icons: Display the app shortcut icons.

Arrow: Displays the next pages on the audio/information screen.

 **Display Mode Icon:** Changes the audio/information screen brightness. Select

 once and select  or  to make an adjustment.

Mode Change Switch Icons: Display icons to change the mode directly.

 (Seek/Skip) **Buttons:** Press to change station, song or file.

VOL/  AUDIO (Volume/Power) Knob: Turns the audio system on and off and turns to adjust the volume.

 **(Back) Button:** Presses to go to back to the previous screen.

 **(Home) Button:** Presses to go to the home screen.

USB Ports

On the front panel

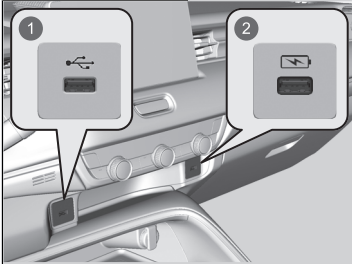

- 1 Playing audio files and connecting compatible phones
- 2 Only for charging devices

■ On the front panel (🎵)

The USB port (2.5A) on the front panel is for charging devices, playing audio files and connecting compatible phones with Apple CarPlay or Android Auto.

- ▶ To prevent any potential issues, be sure to use an Apple MFi Certified Lightning Connector for Apple CarPlay, and for Android Auto, the USB cables should be certified by USB-IF to be compliant with USB 2.0 Standard.

■ On the front panel (⚡)

The USB port (2.5A) on the front panel is only for charging devices.

- ▶ You cannot play music even if you have connected music players to it.

■ On the back of the console compartment*

The USB ports (2.5A) are only for charging devices.

- ▶ You cannot play music even if you have connected music players to them.

On the back of the console compartment*

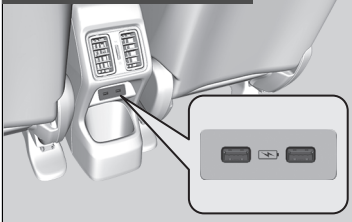

USB Ports

- Do not leave the iPod or USB flash drive in the vehicle. Direct sunlight and high temperatures may damage it.
- We recommend that you use a USB cable if you are attaching a USB flash drive to the USB port.
- Do not connect the iPod or USB flash drive using a hub.
- Do not use a device such as a card reader or hard disk drive, as the device or your files may be damaged.
- We recommend backing up your data before using the device in your vehicle.
- Displayed messages may vary depending on the device model and software version.

USB charge

The USB port can supply up to 2.5A of power. It does not output 2.5A unless requested by the device. For amperage details, read the operating manual of the device that needs to be charged.



Under certain conditions, a device connected to the port may generate noise to the radio station you are listening to.

* Not available on all models

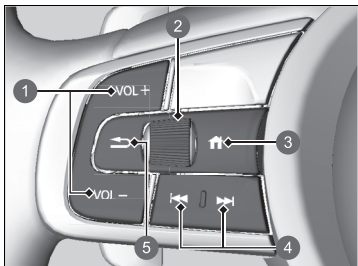
■ Audio Remote Controls



Allow you to operate the audio system while driving. The information is shown on the driver information interface.

- ① **VOL +** / **VOL -** (Volume) Buttons
- ② Left Selector Wheel
- ③  (Home) Button
- ④  (Seek/Skip) Buttons
- ⑤  (Back) Button



VOL + / **VOL -** (Volume) Buttons

Press VOL +: To increase the volume.

Press VOL -: To decrease the volume.

Left Selector Wheel

- When selecting the audio mode

Press the  (home) button, then roll up or down to select  (audio) on the driver information interface, and then press the left selector wheel.

▶▶ Audio Remote Controls

Some modes appear only when an appropriate device or medium is used.

Depending on the *Bluetooth*® device you connect, some functions may not be available.

Press the  (back) button for the driver information interface to go back to the previous screen or cancel a command.

Press the  (home) button to go back to the home screen of the driver information interface.











Roll up or down:

To cycle through the audio modes, roll up or down and then press the left selector wheel:

FM/AM/DAB/iPod/USB/Apple CarPlay/Android Auto/*Bluetooth*® Audio

▶ Depending on a connected device, the displayed modes may be changed.

⏮/⏭ (Seek/Skip) Buttons

- When listening to the radio
 - Press** : To select the next preset radio station.
 - Press** : To select the previous preset radio station.
 - Press and hold** : To select the next strong station.
 - Press and hold** : To select the previous strong station.
- When listening to an iPod, USB flash drive, *Bluetooth*® Audio, or Smartphone Connection
 - ▶ Depending on a connected device, operations may be changed.
 - Press** : To skip to the next song.
 - Press** : To go back to the previous song.
- When listening to a USB flash drive
 - Press and hold** : To skip to the next folder.
 - Press and hold** : To go back to the previous folder.
- When listening to an iPod:
 - Press and hold** : To skip to the next song.
 - Press and hold** : To go back to the previous song.

On-Board Owner's Manual*

You can view the content of the owner's manual on the Display Audio.

■ Open the Owner's Manual

1. Select  **All Apps**.
2. Select **Owner's Manual**.

■ Install/Update the Owner's Manual

When you can install or update the owner's manual, the notification will be sent automatically.

To update:

1. Tap the notification.
 - ▶ The version screen will display.
2. Select items to be updated.
3. Tap **Update**.

If you unselect an item on the version screen, you will not receive any notifications for it.

⌘ On-Board Owner's Manual*

This function does not cover all languages available for the Display Audio.

Changing the language of the Display Audio will also change the language of the owner's manual. If the owner's manual is not available or installed in that language, the owner's manual will default to English.

⌘ Install/Update the Owner's Manual

There may be differences in the displayed content depending on the version of the owner's manual.

If the owner's manual is not installed yet, you can install it via Wi-Fi.



 **Connecting to a Wi-Fi Hotspot** P. 294

For languages except English, German, French, Italian and Spanish

If you install the owner's manual in a new language, the owner's manual you previously downloaded will be removed.

Voice Control Operation *, *1

Your vehicle has a voice control system that allows hands-free operation.

The voice control system uses the  (talk) and  (back) buttons on the steering wheel and a microphone near the map lights on the ceiling.

Voice Recognition

To achieve optimum voice recognition when using the voice control system:

- Make sure the correct screen is displayed for the voice command that you are using.

The system recognises only certain commands.

Available voice commands.

 **Voice Portal Screen** P. 256



- Close the windows.
- Adjust the dashboard and side vents so air does not blow onto the microphone on the ceiling.
- Speak clearly in a clear, natural speaking voice without pausing between words.
- Reduce any background noise if possible. The system may misinterpret your command if more than one person is speaking at the same time.

*1: Languages that the voice control system recognises are English, German, French, Spanish, and Italian.

* Not available on all models

Continued

Voice Control Operation *, *1

When you press the  button, a helpful prompt asks what you would like to do. Press and release the  button again to bypass this prompt and give a command.

■ Voice Portal Screen

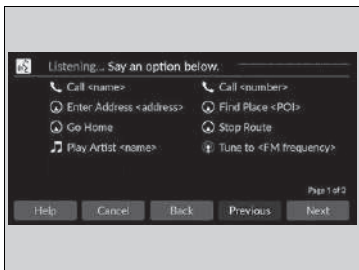

When the  (talk) button is pressed, available voice commands appear on the screen.
For a complete list of commands, say “*Help*” after the beep.

Depending on the selected mode, the displayed commands are different on the voice portal screen. The commands recognised are the same regardless of which screen is selected.
Normal Mode: A list of example commands is displayed to quickly complete your desired function.
Assist Mode: A list of basic commands is displayed to guide you step by step through the voice menu.

You can change the mode on the **General Settings** screen.
 **Voice Control*** P. 310

The system only recognises the commands on the following pages, at certain screens. Free form voice commands are not recognised.

■ General Commands

When the voice portal screen is displayed, it will change to the top screen of each function by using the global commands.

- *Music Search*
- *AM*
- *FM*
- *Navigation*
- *Phone*

■ Phone Commands

This can be only used when the phone is connected. When the system recognises the Phone command, the screen will change the dedicated screen for the voice recognition of the phone.

■ Phone Commands

- *Call <name>*
 - *Call <number>*
- The system recognises an only contact name in the stored phonebook of your phone. If full name is registered in first name field, the system will recognise the first name and last name as one contact name.

Phone commands are not available if using Apple CarPlay.

■ Audio Commands

When the system recognises the Audio command, the screen will change the dedicated screen for the voice recognition of the audio.

■ FM Commands

- *Tune to <FM frequency>*

■ AM Commands

- *Tune to <AM frequency>*

■ iPod Commands

- *List Album* <name>
- *List Artist* <name>
- *List Genre* <name>
- *List Playlist* <name>
- *Play* <artist> <album>
- *Play*
- *Play Album* <name>
- *Play Artist* <name>
- *Play Genre* <name>
- *Play Music* <text:media_combo>
- *Play Playlist* <name>
- *Play Song* <name>

■ USB Commands

- *List Album* <name>
- *List Artist* <name>
- *List Playlist* <name>
- *Play* <artist> <album>
- *Play*
- *Play Album* <name>
- *Play Artist* <name>
- *Play Music* <text:media_combo>
- *Play Playlist* <name>
- *Play Song* <name>

■ Navigation Commands

The screen changes to the navigation screen.

☞ **Refer to the Navigation System Manual**

■ Standard Commands

- *Voice Help*
- *Cancel*
- *Back*

Voice Help are readout voice guidance for Help on current screen.

■ List Commands

- *Previous*
- *Next*
- *Yes*
- *No*

Audio/Information Screen

Displays the audio status and clock. From this screen, you can go to various setup options.

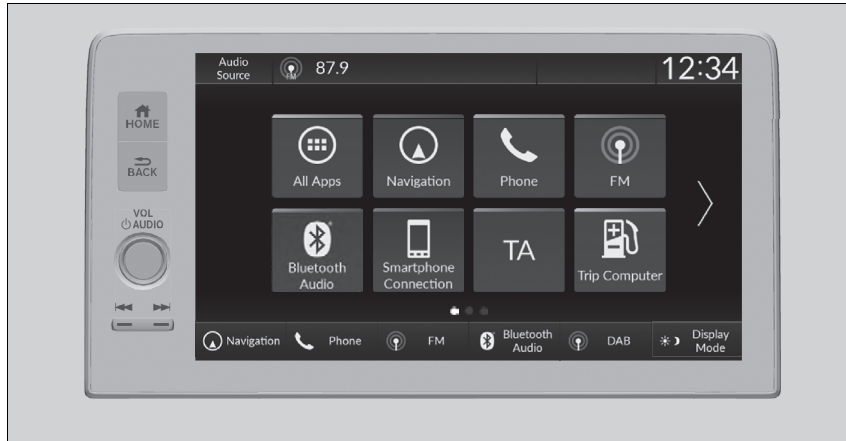

▶▶ Audio/Information Screen

Touchscreen Operation

- Use simple gestures - including touching, swiping, and scrolling - to operate certain audio functions.
- Some items may be greyed out during driving to reduce the potential for distraction.
- You can select them when the vehicle is stopped or use voice commands*.
- Wearing gloves may limit or prevent touchscreen response.

You can change the touchscreen sensitivity setting.

▶▶ **Customized Features** P. 304

■ App Shortcut Function

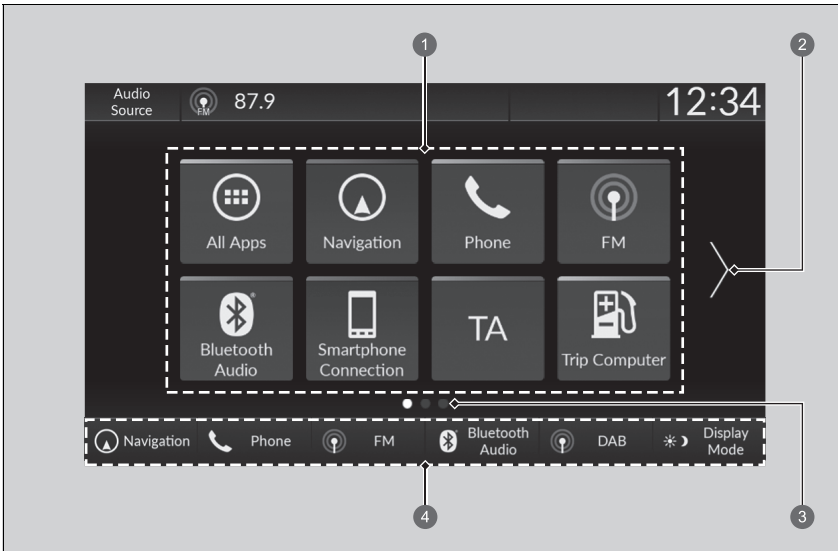

- ① App Shortcut Icons
- ② Arrow
- ③ Page Indicator
- ④ Mode Change Switches

■ To move to the next screen

Selecting  or , or swiping the screen left or right changes to the next screen.

▶▶ App Shortcut Function



The home screen can be added up to 6 pages.

Press the  button to go directly back to the first page of the home screen from any page.

■ To add app icons on the home screen

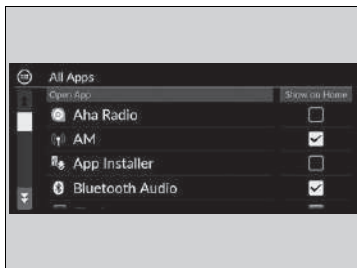
App icons can be added on the home screen.



1. Press the  button.
2. Select  **All Apps**.
3. Select the box checked on the desired apps.

▶▶ To add app icons on the home screen

Pre-installed apps may not start up normally. If this occurs, you need to re-start the system. Set the power mode to VEHICLE OFF, then set the power mode to ON. After that, start up an app again. If you are still unable to start up the apps, you need to reset the system.

▶ **Defaulting All the Settings** P. 317

If you perform **Factory Data Reset**, it may reset all the settings to their factory default.

▶ **Defaulting All the Settings** P. 317

In case those apps still do not start up normally even after **Factory Data Reset**, contact your dealer.

■ To move icons on the home screen

You can change location on the home screen.



1. Press the  button.
2. Select and hold an icon.
 - ▶ The screen switches to the customization screen.
3. Drag and drop the icon to where you want it to be.
4. Select **Done**.
 - ▶ The screen will return to the home screen.

▶▶ To move icons on the home screen

Select **Tips** to show tips. To hide them, select it again.

Continued

■ To remove icons on the home screen

You can delete the icons on the home screen.



1. Press the **HOME** button.
2. Select and hold an icon.
 - ▶ The screen switches to the customization screen.
3. Drag and drop the icon you want to remove to the header area.
 - ▶ The icon is removed from the home screen.
4. Select **Done**.
 - ▶ The screen will return to the home screen.

▶▶ To remove icons on the home screen

Apps will not be deleted by deleting the icon on the home screen.

Select **Tips** to show tips. To hide them, select it again.

■ To shortcut icons on the home screen

You can store up to six icons on the bottom of the home screen.



1 Mode Change Switches

1. Press the  button.
2. Select and hold an icon.
 - ▶ The screen switches to the customization screen.
3. Drag and drop the icon you want to store to the bottom of the home screen.
 - ▶ The icon is stored on the mode change switch area.
4. Select **Done**.
 - ▶ The screen will return to the home screen.

▶▶ To shortcut icons on the home screen

Select **Tips** to show tips. To hide them, select it again.

■ Status Area

Shows the indicators of the information for the vehicle, connected phones, etc. in the header area. You can confirm the detail information by selecting these icons.



1. Select the system status icon.
 - ▶ The status area appears.
2. Select an item to see the details.
3. Press the **BACK** button or select the system status icon to close the area.

① System Status Icon

■ Selecting an Audio Source



Select **Audio Source** on the header area, then select an icon on the source list to switch the audio source.

■ Limitations for Manual Operation

Certain manual functions are disabled or inoperable while the vehicle is in motion. You cannot select a greyed-out option until the vehicle is stopped.

Clock Setup

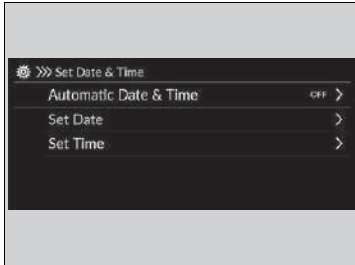

■ Adjusting the Clock

You can adjust the time manually and set the wallpaper of the clock in the audio/information screen.





1. Press the  button.
2. Select **General Settings**.
3. Select **System**.
4. Select **Date & Time**.
5. Select **Set Date & Time**.
6. Select **Automatic Date & Time**, then select **OFF**.

To adjust date:

7. Select **Set Date**.
8. Select /.
9. Select **Save** to set the date.



To adjust time:

7. Select **Set Time**.
8. Select /.
9. Select **Save** to set the time.

▶▶ Adjusting the Clock

The clock is automatically updated through the audio system.

You can also adjust the clock by touching the clock displayed on the header area of the audio/information screen, **Clock** displayed on the home screen, or  **All Apps**.

1. Touch the clock on the screen.
The clock screen of the face-type appears.
2. Select **Settings**.
3. Select **Date & Time**.
4. Select **Set Date & Time**.
5. Select **Automatic Date & Time**, then select **OFF**.
6. Select **Set Date** or **Set Time**.
7. Adjusting the dates, hours and minutes by selecting /.
8. Select **Save** to set the time.

You can customise the clock display.

 **System** P. 305

■ Clock Wallpaper Setup

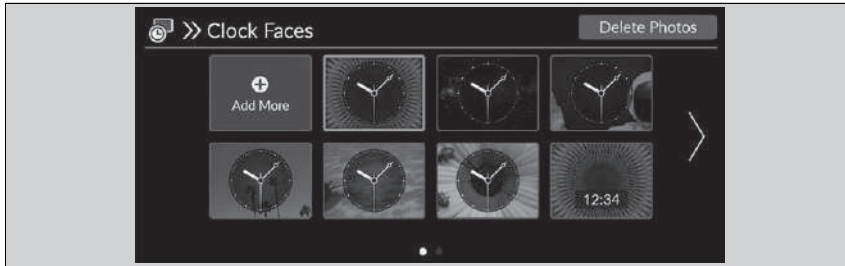



■ Import clock wallpaper

1. Connect the USB flash drive to the USB port.
 - ▶ **USB Ports** P. 251
2. Press the **HOME** button.
3. Select **Clock**.
 - ▶ If **Clock** is not displayed on the home screen, select **All Apps**.
4. Select **Settings**.
5. Select **Clock Faces**.
6. Select **Add More**.
 - ▶ The image of the pictures stored in the USB flash drive are displayed on the list.
7. Select a desired picture to import.
 - ▶ Multiple pictures can be selected at the same time.
8. Select **OK**.
 - ▶ The selected pictures are displayed.
9. Select **Transfer**.
 - ▶ It will return to the clock wallpaper setting screen.



⌘ Clock Wallpaper Setup

- When importing wallpaper files, the image must be in the USB flash drive's root directory. Images in a folder cannot be imported.
- The file name must be less than 64 bytes.
- The file format of the image that can be imported is BMP (bmp) or JPEG (jpg).
- The individual file size limit is less than 10 MB.
- If the USB flash drive does not have any pictures, the message appears.
- Up to 11 pictures can be imported.
- The maximum image size is 4,096 x 2,304 pixels. If the image size is less than 1,280 x 720 pixels, the image is displayed in the middle of the screen with the extra area appearing in black.

■ Select clock wallpaper

1. Press the  button.
2. Select **Clock**.
 - ▶ If **Clock** is not displayed on the home screen, select  **All Apps**.
3. Select **Settings**.
4. Select **Clock Faces**.
5. Select a desired picture to set.
 - ▶ The preview is displayed on the screen.
6. Select **Save**.
 - ▶ The clock screen which the wallpaper has been set is displayed.

■ Delete clock wallpaper

1. Press the  button.
2. Select **Clock**.
 - ▶ If **Clock** is not displayed on the home screen, select  **All Apps**.
3. Select **Settings**.
4. Select **Clock Faces**.
5. Select **Delete Photos**.
6. Select a desired picture to delete.
 - ▶ Multiple pictures can be selected at the same time.
7. Select **OK**.
 - ▶ The selected pictures are displayed.
8. Select **Delete**.
 - ▶ It will return to the clock wallpaper setting screen.

Adjusting the Sound

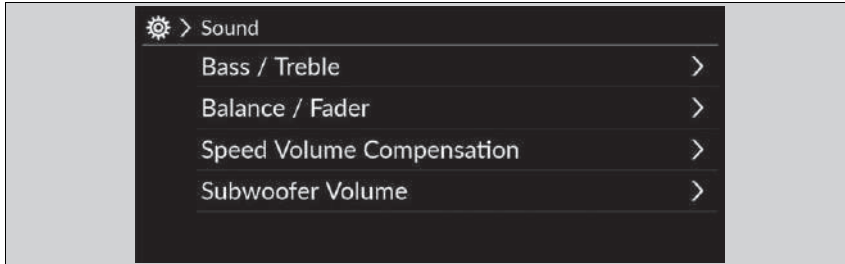

1. Select an audio source.
2. Select **Sound**.
3. Select the setting you want.

Select an item from the following choices:

- **Bass / Treble:** Treble, Midrange, Bass
- **Balance / Fader:** Balance, Fader
- **Speed Volume Compensation:** Speed Volume Compensation (SVC)
- **Subwoofer Volume*:** Sub Woofer, Centre Speaker

Adjusting the Sound

The SVC adjusts the volume level based on the vehicle speed. As you go faster, audio volume increases. As you slow down, audio volume decreases.

You can also adjust the sound the following procedure.

1. Press the  button.
2. Select **General Settings**.
3. Select **Sound**.

To reset each setting for **Bass / Treble**, **Balance / Fader**, **Speed Volume Compensation**, and **Subwoofer Volume***, select **Default** on each setting screen.



* Not available on all models



Display Setup

You can set the screen brightness separately for Day and Night modes.

■ Switching Display Mode Manually



Select   (Display Mode).

- The brightness bar is displayed for a few seconds.
- Select  or  to adjust the brightness.

►► Display Setup

You can adjust the screen brightness by swiping or tapping on the brightness bar.

You can also change the screen brightness on the following procedures.

1. Press the  button.
2. Select **General Settings**.
3. Select **Display**.
4. Select the setting you want.

To reset the settings, select **Default**.



System Updates



The audio system's firmware can be updated with a Wi-Fi connection, or with a USB device.

Models with TCU

The audio system's firmware can be also updated with the telematics control unit (TCU) through the subscription-based service.

How to Update

When the audio system update is available, the notification is shown on the status area. Use the following procedure to update the system.

1. Press the  button.
2. Select **System Updates**.
 - ▶ If **System Updates** is not displayed on the home screen, select  **All Apps**.
 - ▶ The system will check for updates.
 - ▶ If the update icon is appeared on the home screen, select the status icon.
 - ▶ **Status Area** P. 264
3. Select **Download**.
 - ▶ A notification appears on the screen if need to user acceptance for download.
4. Select **Install Now** or **Install While Vehicle Off**.
 - ▶ A notification appears on the screen if the update is ready.

How to Update

You can update the system via Wi-Fi, but cannot use the captive portal that require login or agreement the terms of use on the browser.

Your download will be cancelled if:

- Your Wi-Fi connection is severed.
- You turn off the power system when the 12-volt battery is low on power.

Your download will recommence the next time a Wi-Fi connection is established.

For the 12-volt battery protection, **Install While Vehicle Off** cannot be selected when the battery is low on power. If you want to install the updated data, recharge the battery or select **Install Now**.

Continued

■ System Updates Settings

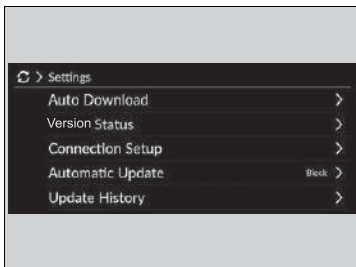



The following settings can be set.

- **Auto Download**
- **Version Status**
- **Connection Setup**
- **Automatic Update**
- **Update History**

■ Automatic download settings

Use the following procedure to change to the automatic download setting.

1. Press the  button.
2. Select **System Updates**.
 - ▶ If **System Updates** is not displayed on the home screen, select  **All Apps**.
3. Select **Settings**.
4. Select **Auto Download**.
5. Select the access point, then select **Allow**.
 - ▶ If you do not want to system update automatically, select **Block**.



■ View a version and update status

Use the following procedure to confirm the version and update status.

1. Press the  button.
2. Select **System Updates**.
 - ▶ If **System Updates** is not displayed on the home screen, select  **All Apps**.
3. Select **Settings**.
4. Select **Version Status**.



■ Connection setup

Use the following procedure to connect to the Internet via a Wi-Fi network.

1. Press the  button.
2. Select **System Updates**.
 - ▶ If **System Updates** is not displayed on the home screen, select  **All Apps**.
3. Select **Settings**.
4. Select **Connection Setup**.
5. Select **OK**.
6. Select **Change Mode**.
7. Select **Network**.
 - ▶ If the vehicle's Wi-Fi is turned off, select **OFF**.



■ Automatic update settings

Use the following procedure to change to the automatic update setting.

1. Press the  button.
2. Select **System Updates**.
 - ▶ If **System Updates** is not displayed on the home screen, select  **All Apps**.
3. Select **Settings**.
4. Select **Automatic Update**.
5. Select **Accept**.
 - ▶ If you do not want to system update automatically, select **Decline**.



■ View the update history

Use the following procedure to confirm the update history.



1. Press the  button.
2. Select **System Updates**.
 - ▶ If **System Updates** is not displayed on the home screen, select  **All Apps**.
3. Select **Settings**.
4. Select **Update History**.

■ How to Update Wirelessly

■ Wireless connection mode setup



1. Press the  button.
2. Select **System Updates**.
 - ▶ If **System Updates** is not displayed on the home screen, select  **All Apps**.
3. Select **Settings**.
4. Select **Connection Setup**.
5. Select **OK**.
6. Select **Change Mode**.
7. Select **Network**.
 - ▶ It will return to the network list.
8. Select an access point from the network list.
 - ▶ If the audio system requires a password, enter a password.
9. Select **Connect**.

■ How to update



1. Press the  button.
2. Select **System Updates**.
 - ▶ If **System Updates** is not displayed on the home screen, select  **All Apps**.
3. Select **via Wireless**.
4. Select **Download**.
 - ▶ A notification appears on the screen if need to user acceptance for download.
5. Select **Install Now** or **Install While Vehicle Off**.
 - ▶ A notification appears on the screen if the update is ready.

■ How to Update with a USB Device

■ Download the update files from the server

1. Press the  button.
2. Select **System Updates**.
 - ▶ If **System Updates** is not displayed on the home screen, select  **All Apps**.
3. Select **Other Methods**.
4. Select **Via USB**.
 - ▶ A notification appears on the screen.
5. Connect a USB device into the USB port.
 - ▶ The inventory data is copied into the USB device.
 - ▶  **USB Ports** P. 251
6. Remove the USB device from the USB port.
7. Connect the USB device into your computer, and then download the update files.
 - ▶ Follow the link to download the required software update files. Refer to <https://usb.honda.com> for instructions.

■ Update the audio system

1. Press the  button.
2. Select **System Updates**.
3. Select **Other Methods**.
4. Select **Via USB**.
 - ▶ A notification appears on the screen.
5. Connect the USB device with the update files into the USB port.
 - ▶ A notification appears on the screen.
 - ▶  **USB Ports** P. 251
6. Select **Install Now**.
 - ▶ A notification appears on the screen if the update is successful.

⌘ How to Update with a USB Device

A USB device with a minimum of 8 GB of free space or more is recommended.

Be sure to delete any previous inventory or update files from the USB before starting the USB update process.

Playing FM/AM Radio



① Settings Icon

② Sound Icon

③ Preset Icons

④ Station List Icon

⑤ Scan Icon

⑥ Tune Icon

⑦ Seek Icon

■ Preset Memory

Tunes the radio frequency for preset memory.

To store a station:

1. Tune to the selected station.
2. Select and hold the preset icon to store that station.
 - ▶ Selecting **Press & Hold** can be set a new preset station.

■ Station List

Lists the strongest stations on the selected band.

1. Select **Station List** to display a list.
2. Select the station.

■ Manual update

Updates your available station list at any time.



1. Select **Station List** to display a list.
2. Select **Refresh**.

■ Scan

Samples each of the strongest stations on the selected band for 10 seconds.

To begin scanning, select **Scan**, and to turn it off, select **Cancel** or press the  button.

■ Seek

Selects  or  to search the selected band up or down for a station with a strong signal.

▶▶ Preset Memory

The **ST** indicator appears on the display indicating stereo FM broadcasts.

Switching the Audio Mode

Roll up or down to select  (audio) on the left selector wheel.

▶▶ **Audio Remote Controls** P. 252

You can store 12 AM/FM stations into preset memory.

■ Sound

Adjusts the sound settings.

▶ **Adjusting the Sound** P. 269

■ Radio Frequency Manual Tune Screen

Selects to use the on-screen keyboard for entering the radio frequency directly.



① On-screen Keyboard

▶ Radio Frequency Manual Tune Screen

You can tune the range of FM frequency between 87.5 to 108.0MHz.

◀▶ icons:

Select ◀ or ▶ to tune the radio frequency.

■ Radio Data System (RDS)

Provides text data information related to your selected RDS-capable FM station.

■ To find an RDS station from Station List

1. Select **Station List** to display a list while listening to an FM station.
2. Select the station.

■ Manual update

Updates your available station list at any time.

1. Select **Station List** to display a list while listening to an FM station.
2. Select **Refresh**.

■ Traffic announcement (TA)

The TA standby function allows the system to stand by for traffic announcements in any mode while the function is on. The last tuned station must be an RDS capable traffic program station.

To turn the function on: Select **TA**. When a traffic announcement begins, the information screen appears on the audio/information screen. The system returns to your last selected mode after the traffic announcement is finished.

- ▶ If you want to go back to your last selected mode during the traffic announcement, select **Stop**.

To turn the function off: Select **TA** again.

☒ Radio Data System (RDS)

When you select an RDS-capable FM station, the RDS automatically turns on, and the frequency display changes to the station name. However, when the signals of that station become weak, the display changes from the station name to the frequency.

☒ Traffic announcement (TA)

The **TA** indicator appears on the header area while the TA standby function is on.

If you select **Scan** while the TA standby function is on, the system searches TP station only.

Selecting **TA** while the traffic announcement is on does not cancel the TA standby function.

■ Settings

Changes the RDS settings.

1. Settings.

2. Select an option.

- **TA-Information:** Turns on and off the traffic information. (**ON/OFF***1)
- **AF:** Turns on and off to automatically change the frequency of the same program you enter different regions. (**ON***1/**OFF**)
- **REG:** Turns on and off to keep the same stations within that region even if the signal gets weak. (**ON***1/**OFF**)
- **NEWS:** Turns on and off to automatically to tune to the news program. (**ON/OFF***1)

*1: Default Setting

Playing DAB (Digital Audio Broadcasting)

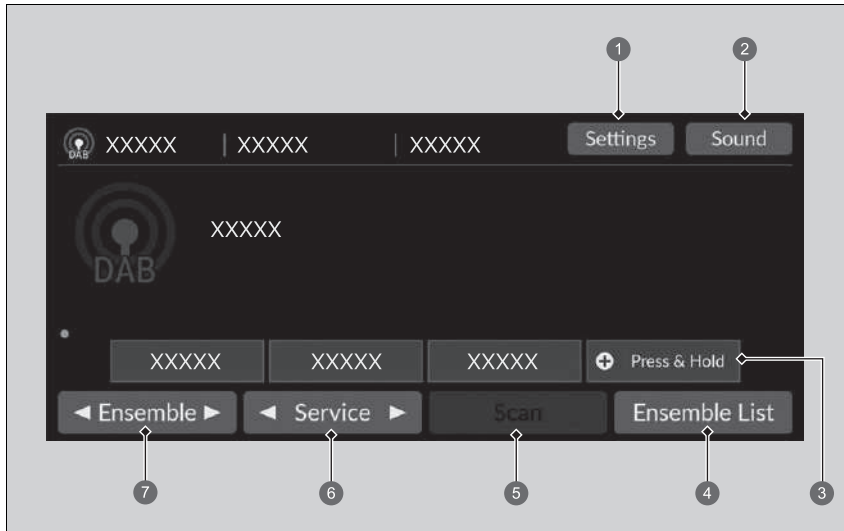

- ① Settings Icon
- ② Sound Icon
- ③ Preset Icons
- ④ Ensemble List Icon
- ⑤ Scan Icon
- ⑥ Service Icons
- ⑦ Ensemble Icons

■ Preset Memory

Tunes the preset frequency.

To store a service:

1. Tune to the selected service.
2. Select and hold the preset icon to store that station.
 - Selecting **Press & Hold** can be set a new preset station.

■ Ensemble List

Lists the receivable ensembles on the selected service.

1. Select **Ensemble List** to display a list.
2. Select the ensemble.

■ Manual update

Updates your available ensemble list at any time.

1. Select **Ensemble List** to display a list.
2. Select **Refresh**.

■ Ensemble

Tunes the ensemble.

1. Select ◀ to ▶ the tune ensemble.
2. Select and hold ◀ or ▶ to search the selected service up to down for an ensemble until a receivable ensemble is found.

■ Service

Tunes the service component.

To tune it, select ◀ or ▶.

⌘ Preset Memory

Switching the Audio Mode

Roll up or down to select  (audio) on the left selector wheel.

► **Audio Remote Controls** P. 252

You can store 12 DAB stations into preset memory.

■ Scan

Samples each of the receivable ensemble or service on the selected service for 10 seconds.

To begin scanning, select **Scan**, and to turn it off, select **Cancel** or press the  button.

■ Sound

Adjusts the sound settings.

 **Adjusting the Sound** P. 269

■ Settings

Changes the DAB settings.

- 1. Settings.**
- Select the option you want to change.

*1: Default Setting

Playing an iPod

Using your USB connector, connect the iPod to the USB port, then select the USB mode.

➔ **USB Ports** P. 251

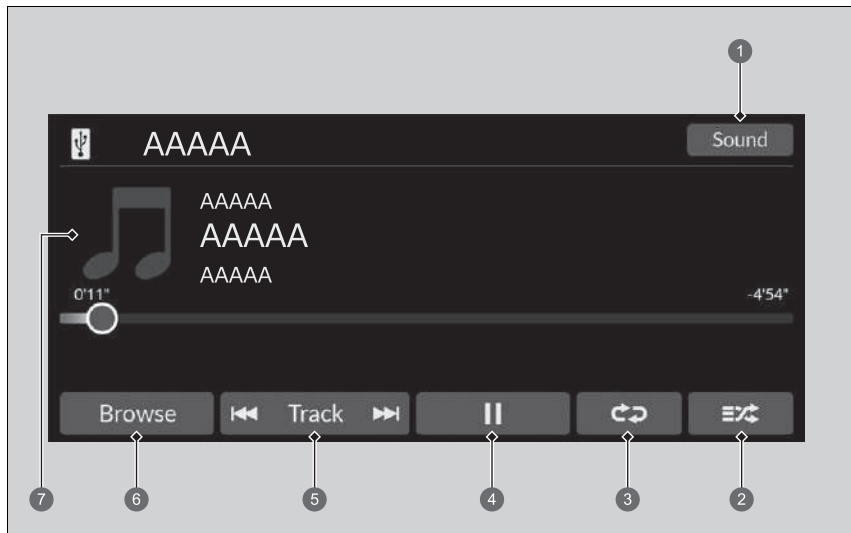

- ① Sound Icon
- ② Shuffle Icon
- ③ Repeat Icon
- ④ Play/Pause Icon
- ⑤ Track Icons
- ⑥ Browse Icon
- ⑦ Cover Art

▶▶ Playing an iPod

Available operating functions vary on models or versions. Some functions may not be available on the vehicle's audio system.

If there is a problem, you may see an error message on the audio/information screen.

➔ **iPod/USB Flash Drive** P. 337

If you operate the music app on your iPhone/iPod while the phone is connected to the audio system, you may no longer be able to operate the same app on the audio/information screen. Reconnect the device if necessary.

If a smartphone is connected via Apple CarPlay or Android Auto, the iPod/USB source will be unavailable and audio files on the phone will be playable only within Apple CarPlay or Android Auto.

■ How to Select a Song from the Music Search List

You can select to display the music search list screen.

1. Select **Browse**.
2. Select a search category.
3. Continue making selections until you find the song of your choice.

■ How to Select a Play Mode

You can select shuffle and repeat modes when playing a song.

■ Shuffle/Repeat

Select shuffle or repeat icon repeatedly until a desired mode.

Shuffle

 (shuffle off): Shuffle mode to off.

 (shuffle all songs): Plays all available songs in a selected list in random order.

Repeat

 (repeat off): Repeat mode to off.



 (repeat song): Repeats the current song.

 (repeat all): Repeats the all songs.

■ To pause or resume a song

Select the play/pause icon.

■ How to Change a Song

You can select  or  to change songs. Select and hold to move rapidly within a song.

■ Sound

You can adjust the sound settings.

➤ **Adjusting the Sound** P. 269

Playing a USB Flash Drive

Your audio system reads and plays sound and video files on a USB flash drive. Connect your USB flash drive to the USB port, then select the USB mode.

📌 **USB Ports** P. 251

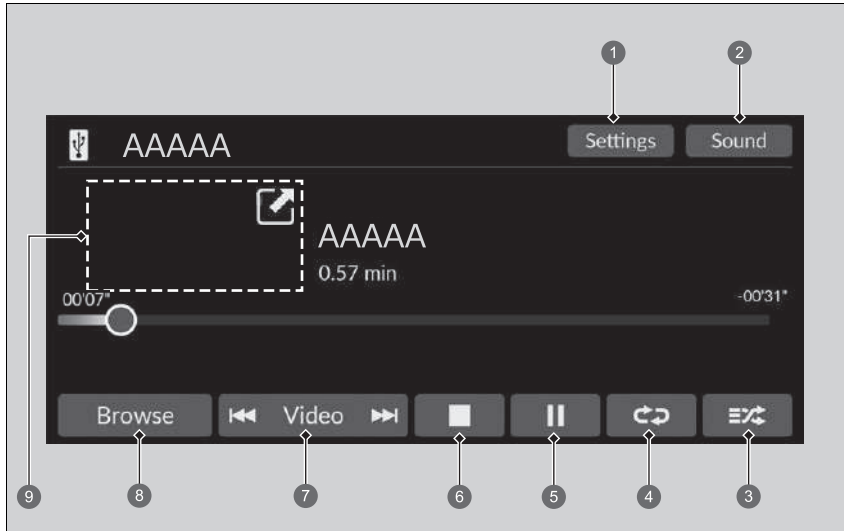

- ① **Settings Icon***
- ② **Sound Icon**
- ③ **Random Icon**
- ④ **Repeat Icon**
- ⑤ **Play/Pause Icon**
- ⑥ **Stop Icon***
- ⑦ **Track*/Video* Icons**
- ⑧ **Browse Icon**
- ⑨ **Cover Art* (Playing a music)/ Mini Player* (Playing a video)**

▶▶ Playing a USB Flash Drive

You can use the following formats to play sound or video files on a USB flash drive.

When playing a sound file: MP3, WMA, AAC*1, FLAC, PCM/WAVE

When playing a video file: MP4, AVI, MKV, ASF/WMV

*1: Only AAC format files recorded with iTunes are playable on this unit.

* Not available on all models

Continued

■ How to Select a File from the Music Search List

You can select to display the music search list screen.

1. Select **Browse**.
2. Select **Current Playlist, Music, or Video**.
3. Continue making selections until you find the file or video of your choice.

▶▶ Playing a USB Flash Drive

Use the recommended USB flash drives.

- ▶ **General Information on the Audio System**
P. 338

WMA and AAC files protected by digital rights management (DRM) cannot be played.

The audio system displays **Unplayable File**, then skips to the next file.

If there is a problem, you may see an error message on the audio/information screen.

- ▶ **iPod/USB Flash Drive** P. 337

■ How to Select a Play Mode

You can select repeat and random modes when playing a file.

■ Random/Repeat

Select random or repeat icon repeatedly until a desired mode.

Random

 (random off): Random mode to off.

 (random all files): Plays all files in random order.

 (random in folder): Plays all files in the current folder in random order.

Repeat

 (repeat off): Repeat mode to off.

 (repeat file): Repeats the current file.

 (repeat folder): Repeats all files in the current folder.

■ When playing a video file*

 (stop): Select to stop a file.



 / : Select  to shrink a video screen. Select  to expand a video screen.

■ To pause or resume a file

Select the play/pause icon.

■ How to Change a File

Track*/Video* Icons

You can select  or  to change files. Select and hold to move rapidly within a file.

* Not available on all models

■ Sound

You can adjust the sound settings.

- ▶ **Adjusting the Sound** P. 269

■ Settings

Changes the USB settings when playing a video file.

1. Settings.

2. Select an option.

- **Image Settings:** Changes the brightness of the audio/information screen. To reset the settings, select **Default**. (**Brightness/Contrast/Black Level/Colour/Tint**).
- **Aspect Ratio:** Selects the display mode with a different aspect ratio. (**Original/Normal*1/Full/Zoom**)
- **Overlay Clock Location:** Changes the clock display layout. (**Upper right*1/Upper left/Lower right/Lower left/OFF**)

*1: Default Setting

Playing *Bluetooth*® Audio

Your audio system allows you to listen to music from your *Bluetooth*-compatible phone.

This function is available when the phone is paired and connected to the vehicle's Hands-Free Telephone (HFT) system.

📖 **Phone Setup** P. 325

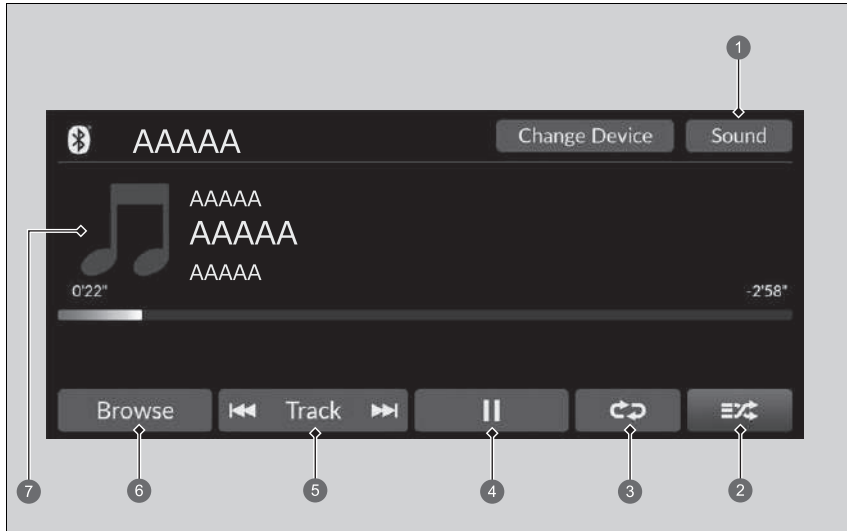

- ① Sound Icon
- ② Shuffle Icon
- ③ Repeat Icon
- ④ Play/Pause Icon

- ⑤ Track Icons
- ⑥ Browse Icon
- ⑦ Cover Art

▶▶ Playing *Bluetooth*® Audio

Not all *Bluetooth*-enabled phones with streaming audio capabilities are compatible with the system. To check if your phone is compatible, ask a dealer.

It may be illegal to perform some data device functions while driving.

Only one phone can be used with HFT at a time. When there are more than two paired phones in the vehicle, the latest paired phone the system finds is automatically connected.

If more than one phone is paired to the HFT system, there may be a delay before the system begins to play.

In some cases, the name of the artist, album, or track may not appear correctly.

Some functions may not be available on some devices.

If a phone is currently connected via Apple CarPlay or Android Auto, *Bluetooth*® Audio from that phone will be unavailable. However, if the other phone is connected to the system, it can be used as *Bluetooth*® Audio by selecting the audio mode.

📖 **Phone Setup** P. 325

■ To Play *Bluetooth*® Audio Files

1. Make sure that your phone is paired and connected to the system.
 📱 **Phone Setup** P. 325
2. Select the *Bluetooth*® Audio mode.

If the phone is not recognised, another HFT-compatible phone, which is not compatible for *Bluetooth*® Audio, may already be connected.

■ How to Select a Play Mode

You can select shuffle and repeat modes when playing a song.

Shuffle

🔀 (shuffle off): Shuffle mode to off.

🔀 (shuffle all songs): Plays all available songs in a selected list in random order.

Repeat

↺ (repeat off): Repeat mode to off.

🔁 (repeat song): Repeats the current song.

🔁 (repeat all): Repeats the all songs.

■ To play or pause a file

Select the play/pause icon.

■ Searching for Music

1. Select **Browse**.
2. Select a search category.
3. Select an item.
 ▶ The selection begins playing.

🔗 To Play *Bluetooth*® Audio Files

To play the audio files, you may need to operate your phone. If so, follow the phone maker's operating instructions.

Switching to another mode pauses the music playing from your phone.

You can change the connected phone by selecting **Change Device**.

📱 **Phone Setup** P. 325

🔗 Searching for Music

Depending on the *Bluetooth*® device you connect, some or all of the lists may not be displayed.

■ Sound

You can adjust the sound settings.

📖 **Adjusting the Sound** P. 269

Wi-Fi Connection

This vehicle is equipped with Wi-Fi connectivity. You can connect to an external Wi-Fi hotspot or communication device. In addition, the vehicle can be used by other communication devices as a Wi-Fi hotspot via the telematics unit (TCU)*.

- Connect the vehicle to a Wi-Fi hotspot
- Use Wi-Fi inside the vehicle

Wi-Fi Connection

Wi-Fi and Wi-Fi Direct are registered trademarks of Wi-Fi Alliance®.



Connecting to a Wi-Fi Hotspot

You cannot go through the setting procedure while a vehicle is moving. Park in a safe place to set the audio system in Wi-Fi mode.

Some mobile phone carriers charge for tethering and smartphone data use. Check your phone's data subscription package.

Check your phone manual to find out if the phone has Wi-Fi connectivity.



You can confirm whether Wi-Fi connection is on or off with the  icon on the system status area. Transmission speed and others will not be displayed on this screen.

 **Status Area** P. 264

In case of Wi-Fi connection with your phone, make sure your phone's Wi-Fi setting is in access point (tethering) mode.

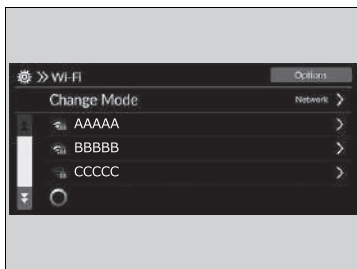
Connecting to a Wi-Fi Hotspot



1. Press the  button.
2. Select **General Settings**.
3. Select **Connections**.
4. Select **Wi-Fi**.
5. Select **OK**.
6. Select **Change Mode**.
7. Select **Network**.
 - ▶ If the data sharing settings is to **OFF**, the message will be displayed on the screen. You need to change to **ON**.
 **System** P. 305
 - ▶ If you want to turn off the Wi-Fi mode, select **OFF**.
8. Select the access point you want to connect to the system.
 - ▶ To add a new network or select the saved networks, select **Options**.
 - ▶ If **Options** is selected, **Add Network** and **Saved Networks** can be registered.

■ Setting the Audio System as a Wi-Fi Hotspot*

You can set the network as a Wi-Fi Hotspot of this audio system. Use the following steps to setup.

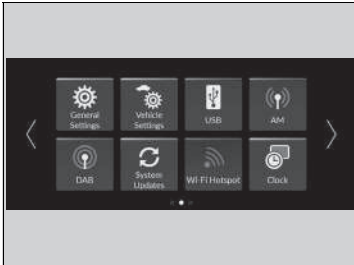

1. Press the button.
2. Select **Wi-Fi Hotspot**.
 - ▶ If **Wi-Fi Hotspot** is not displayed on the home screen, select **All Apps**.
3. Turn on the hotspot.
4. Select **Settings**.
 - ▶ **Network SSID** and **Password** are displayed, and you can change the settings.

The following settings are available for the setup.

- **Network SSID:** Set this network name.
- **Password:** Set password for require entering password when connecting Wi-Fi device to this network.
 - ▶ Passwords can be created with alphanumeric characters and some special characters.

⌘ Setting the Audio System as a Wi-Fi Hotspot*

Special characters that can be used in passwords.

!)	;]
"	*	<	^
#	+	=	_
\$,	>	`
%	-	?	{
&	.	@	
'	/	[}
(:	~	

* Not available on all models

Apple CarPlay

If you connect an Apple CarPlay-compatible iPhone to the system via the USB port or wirelessly, you can use the audio/information screen, instead of the iPhone display, to make a phone call, listen to music, view maps (navigation), and access messages.

📖 **USB Ports** P. 251

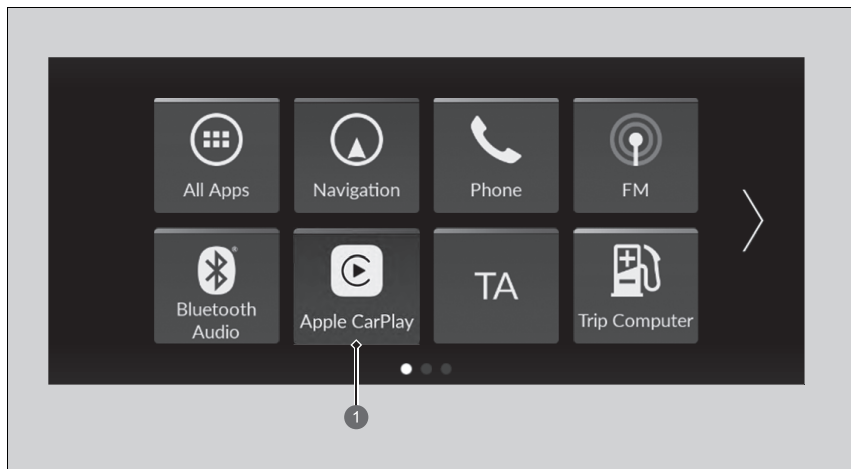

① Apple CarPlay

📖 Apple CarPlay

We recommend that you update iOS to the latest version when using Apple CarPlay.

Park in a safe place before connecting your iPhone to Apple CarPlay and when launching any compatible apps.

While connected to Apple CarPlay, calls are only made through Apple CarPlay. If you want to make a call with the Hands-Free Telephone (HFT) system, turn Apple CarPlay off.

📖 **Setting Up Apple CarPlay** P. 298

When your iPhone is connected to Apple CarPlay, it is not possible to use the *Bluetooth*® Audio or the Hands-Free Telephone (HFT) system. However, other previously paired phones can stream audio via *Bluetooth*® while Apple CarPlay is connected.

📖 **Phone Setup** P. 325

For details on countries and regions where Apple CarPlay is available, as well as information pertaining to function, refer to the Apple homepage.

Apple CarPlay Menu

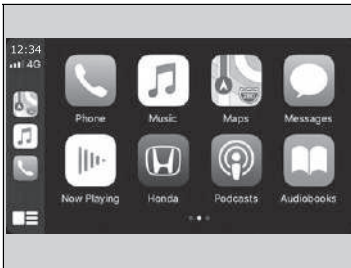

- **Phone**
Access the contact list, make phone calls, or listen to voice mail.
- **Music**
Play music stored on your iPhone.
- **Maps**
Display Apple Maps and use the navigation function just as you would on your iPhone.
- **Messages**
Check and reply to text messages, or have messages read to you.
- **Honda**
Select the Honda icon to go back to the home screen.
- 
Go back to the Apple CarPlay menu screen.

Apple CarPlay

Apple CarPlay Operating Requirements & Limitations

Apple CarPlay requires a compatible iPhone with an active mobile connection and data plan. Your carrier's rate plans will apply.

Changes in operating systems, hardware, software, and other technology integral to providing Apple CarPlay functionality, as well as new or revised governmental regulations, may result in a decrease or cessation of Apple CarPlay functionality and services. Honda cannot and does not provide any warranty or guarantee of future Apple CarPlay performance or functionality.

It is possible to use 3rd party apps if they are compatible with Apple CarPlay. Refer to the Apple homepage for information on compatible apps.

■ Setting Up Apple CarPlay

After you have connected your iPhone to the system via the USB port or wirelessly, use the following procedure to set up Apple CarPlay. Use of Apple CarPlay will result in the transmission of certain user and vehicle information (such as vehicle location, speed, and status) to your iPhone to enhance the Apple CarPlay experience. You will need to consent to the sharing of this information on the audio/information screen.

■ Enabling Apple CarPlay

■ Connecting Apple CarPlay using the USB cable to the USB port

1. Connect the iPhone to the USB port using the USB cable.
 - 📖 **USB Ports** P. 251
 - The confirmation screen will be displayed.
2. Select **Yes**.
 - If you do not want to connect Apple CarPlay, select **No**.

You may change the consent settings under the **Smartphone Connection** settings menu.

■ Connect Apple CarPlay wirelessly

1. Pair and connect the iPhone to the vehicle's Hands-Free Telephone (HFT) system.
 - 📖 **Phone Setup** P. 325
2. Check the box on **Apple CarPlay**.
 - If you select **Apple CarPlay**, you cannot select **Audio** and **Phone**.
3. Select **Connect**.
 - If your iPhone asks to accept for connecting Apple CarPlay, accept for connection.

🔗 Setting Up Apple CarPlay

You can also use the method below to set up Apple CarPlay:

Select **General Settings** →
Smartphone Connection → **Apple CarPlay** →
Select device

Use of user and vehicle information

The use and handling of user and vehicle information transmitted to/from your iPhone by Apple CarPlay is governed by the Apple iOS terms and conditions and Apple's Privacy Policy.

🔗 Connect Apple CarPlay wirelessly

Wireless Apple CarPlay and Hotspot cannot be used at the same time. When using Apple CarPlay and Hotspot at the same time, connect to Apple CarPlay with a USB cable.

■ Operating Apple CarPlay with Siri

Press and hold the  (talk) button to activate Siri.

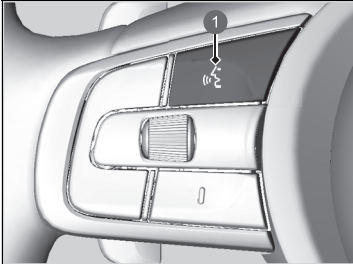

① (Talk) Button

Press and hold to activate Siri.

Press again to deactivate Siri.

Press and release to activate standard voice recognition system.

▣ Operating Apple CarPlay with Siri

Below are examples of questions and commands for Siri:

- What movies are playing today?
- Call dad at work.
- What song is this?
- How's the weather tomorrow?
- Read my latest email.

For more information, please visit www.apple.com/ios/siri.

Android Auto

When you connect an Android phone to the audio system via the USB port, Android Auto is automatically initiated. When connected via Android Auto, you can use the audio/information screen to access the Phone, Google Maps (Navigation), Google Play Music, and Google Now functions. When you first use Android Auto, a tutorial will appear on the screen.

We recommend that you complete this tutorial while safely parked before using Android Auto.

- **USB Ports** P. 251
- **Auto Pairing Connection** P. 302

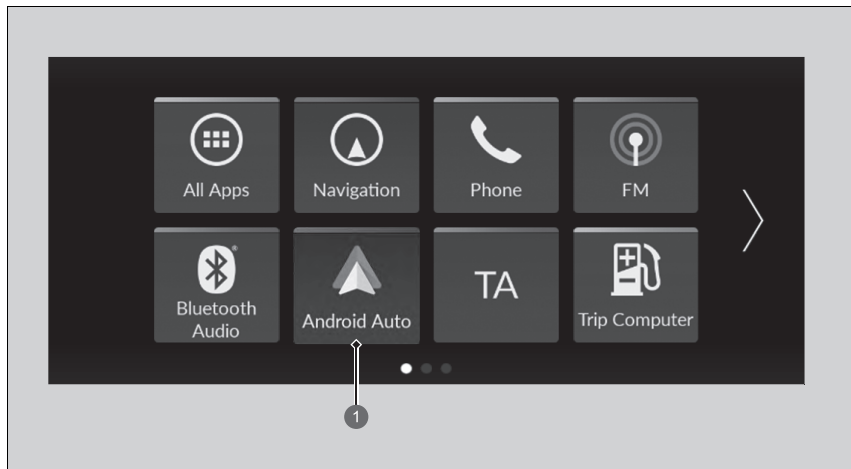

1 Android Auto

Android Auto

We recommend that you update Android OS to the latest version when using Android Auto. *Bluetooth* A2DP cannot be used while your phone is connected to Android Auto.

To use Android Auto on a smartphone with Android 9.0 (Pie) or earlier, you need to download the Android Auto app from Google Play to your smartphone.

Park in a safe place before connecting your Android phone to Android Auto and when launching any compatible apps.

To use Android Auto, connect the USB cable to the USB port.



- **USB Ports** P. 251

When your Android phone is connected to Android Auto, it is not possible to use the *Bluetooth*® Audio. However, other previously paired phones can stream audio via *Bluetooth*® while Android Auto is connected.

- **Phone Setup** P. 325

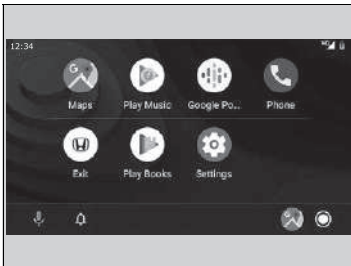
Android Auto Menu



- **Maps**
Display Google Maps and use the navigation function just as you would with your Android phone. When the vehicle is in motion, it is not possible to make keyboard entries. Stop the vehicle in a safe location to undertake a search or provide other inputs.
- **Play Music**
Play Google Play Music and music apps that are compatible with Android Auto. To switch between music apps, press this icon.
- **Phone**
Make and receive phone calls as well as listen to voicemail.
- **Exit**
- 
Operate Android Auto with your voice.
- 
You can check Android notifications.
-  (Android Auto Home)
Display useful information organised by Android Auto into simple cards that appear just when they're needed.

Android Auto

For details on countries and regions where Android Auto is available, as well as information pertaining to function, refer to the Android Auto homepage.

Screens may differ depending on the version of the Android Auto app you are using.

Android Auto Operating Requirements & Limitations

Android Auto requires a compatible Android phone with an active mobile connection and data plan. Your carrier's rate plans will apply.

Changes in operating systems, hardware, software, and other technology integral to providing Android Auto functionality, as well as new or revised governmental regulations, may result in a decrease or cessation of Android Auto functionality and services. Honda cannot and does not provide any warranty or guarantee of future Android Auto performance or functionality.

It is possible to use 3rd party apps if they are compatible with Android Auto. Refer to the Android Auto homepage for information on compatible apps.

■ Auto Pairing Connection

When you connect an Android phone to the unit via the USB port, Android Auto is automatically initiated.

■ Enabling Android Auto

To enable Android Auto after connecting an Android phone to the system, select **Yes** on the screen.

You may change the consent settings under the **Smartphone Connection** settings menu.

☒ Enabling Android Auto

Only initialize Android Auto when you are safely parked. When Android Auto first detects your phone, you will need to set up your phone so that auto pairing is possible. Refer to the instruction manual that came with your phone.

You can use the method below to change Android Auto settings after you have completed the initial setup:

Select General Settings →
Smartphone Connection → Android Auto →
Select device

Use of user and vehicle information

The use and handling of user and vehicle information transmitted to/from your phone by Android Auto is governed by the Google's Privacy Policy.

■ Operating Android Auto with Voice Recognition

Press and hold the  (talk) button to operate Android Auto with your voice.

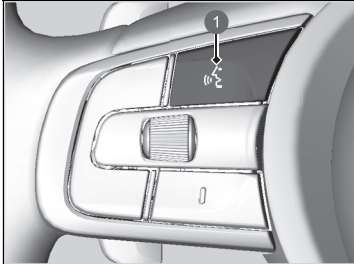

① (Talk) Button

Press and hold to operate Android Auto with your voice.

Press and release to activate standard voice recognition system.

☒ Operating Android Auto with Voice Recognition

Below are examples of commands you can give with voice recognition:

- Reply to text.
- Call my wife.
- Navigate to Honda.
- Play my music.
- Send a text message to my wife.
- Call flower shop.

For more information, please refer to the Android Auto homepage.

You can also activate the voice recognition function by selecting the  icon in the lower-left corner of the screen.

Customized Features

Use the audio/information screen to customize certain features.

■ How to Customize the General Settings

With the power mode in ON, select **General Settings**, then select a setting item.

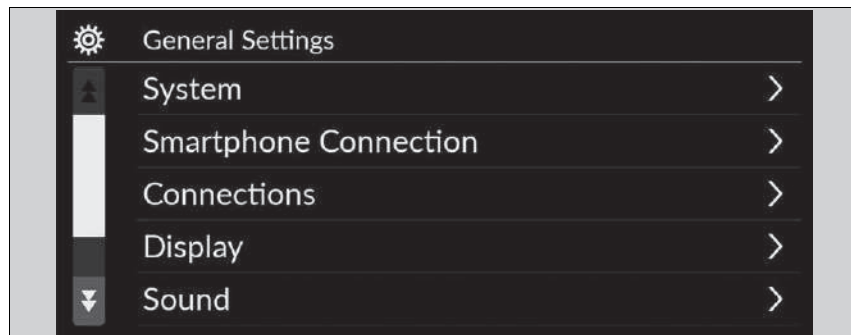

- **System** ➤ P. 305
- **Smartphone Connection** ➤ P. 307
- **Connections** ➤ P. 308
- **Display** ➤ P. 309
- **Sound** ➤ P. 309
- **Camera** ➤ P. 310
- **Voice Control*** ➤ P. 310

» Customized Features

When you customize settings, make sure that the vehicle is at a complete stop and shift to **P**.

■ System

Customizable Features		Description	Selectable Settings	
Date & Time	Automatic Date & Time	Selects ON to have the GPS automatically adjust the clock. Select OFF to cancel this function.	ON*1/OFF	
	Set Date & Time	Set Date	Adjusts date. <input checked="" type="checkbox"/> Adjusting the Clock P. 266	Day/Month/Year
		Set Time	Adjusts time. <input checked="" type="checkbox"/> Adjusting the Clock P. 266	Hour/Minute AM/PM
	Time Zone	Automatic Time Zone	Sets the audio system to automatically adjust the clock when driving through different time zones.	ON*1/OFF
		(Select time zone)	Changes the time zone manually.	—
	Auto Daylight Saving Time	Sets the clock to update based on daylight savings time.	ON*1/OFF	
	Date Format	Select a date format.	MM/DD/YYYY/ DD/MM/YYYY*1/ YYYY/MM/DD	
Time Format	Select a time format.	12-H*1/24-H		



*1:Default Setting

Customizable Features	Description	Selectable Settings
Language	Changes the driver information interface and audio/information screen language separately.	English * ¹ or Turkish * ¹ See other selectable languages on the screen.
Touch Panel Sensitivity	Sets the sensitivity of the touch panel screen.	High/Normal * ¹
System Volumes	System Sounds	Sets the system sound volume level. —
	Text-to-Speech	Sets the text-to-speech volume level. —
	Navigation Guidance	Sets the navigation guidance volume level. —
	Phone Calls	Sets the phone call volume level. —
	Default	Resets all System Volumes settings to default values.
Location and vehicle data sharing	Location and vehicle data sharing Turns the data sharing setting on and off. ▶ Start Up P. 248	ON/OFF * ¹
Refuel Recommend	Turns the refuel recommend function on and off. ▶ Refuel Recommend P. 349	ON * ¹ / OFF

*1:Default Setting

Customizable Features		Description	Selectable Settings
About	Status	Displays the Android setting items.	—
	Legal Information		
	Model Number		
	Android Version		
	Kernel Version		
	Build Number		
Factory Data Reset		Resets all the settings to their factory default.  Defaulting All the Settings P. 317	Continue/Cancel
Detail Information	App Manager	Displays the Android system memory and apps information.	—

■ **Smartphone Connection**

Customizable Features		Description	Selectable Settings
Apple CarPlay	+ Connect New Device	Pairs a new phone to Apple CarPlay.  Phone Setup P. 325	—
	(Saved Devices)	Connects, disconnects, or deletes a paired phone.  Phone Setup P. 325	—
Android Auto	(Saved Devices)	Connects, disconnects, or deletes a paired phone.  Phone Setup P. 325	—

■ Connections

	Customizable Features	Description	Selectable Settings	
Wi-Fi	Change Mode	Changes the Wi-Fi mode.	Network/ Smartphone^{*2}/OFF^{*1}	
	(Available Networks/Connected Devices)	Displays the available network(s) or current connected device(s).	—	
	Options	Add Network	Adds a new network to connect Wi-Fi.	—
		Saved Networks	Saves the connected network.	—
Bluetooth	Options	Bluetooth	Turns the <i>Bluetooth</i> ® on and off.	ON^{*1}/OFF
		Priority Device	Sets a device as the priority device.	—
	+ Connect New Device	Pairs a new phone to HFT. ➤ Phone Setup P. 325	—	
	(Saved Devices)	Connects, disconnects, or deletes a paired phone. ➤ Phone Setup P. 325	—	

*1: Default Setting

*2: Appears only when Apple CarPlay is connected.

■ Display

Customizable Features	Description	Selectable Settings
Day Mode ^{*1}	Changes between the daytime mode and nighttime mode.	—
Night Mode	 Display Setup P. 270	—
Brightness	Changes the brightness of the audio/information screen.	—
Contrast	Changes the contrast of the audio/information screen.	—
Black Level	Changes the black level of the audio/information screen.	—
Default	Resets all customized settings for the brightness, contrast, and black level.	—

*1:Default Setting

■ Sound

Customizable Features	Description	Selectable Settings	
Bass / Treble	Treble	Adjusts the settings of the audio speakers' sound.  Adjusting the Sound P. 269	—
	Midrange		
	Bass		
Balance / Fader			
Speed Volume Compensation			
Subwoofer Volume *			

* Not available on all models

■ Camera

Customizable Features		Description	Selectable Settings
Rear Camera	Fixed Guideline	Shows the guideline that does not move with the steering wheel. ➤ Multi-View Rear Camera P. 493	ON*¹/OFF
	Dynamic Guideline	Shows the guideline that moves with the steering wheel. ➤ Multi-View Rear Camera P. 493	ON*¹/OFF
Cross Traffic Monitor*		Shows arrows on the rear camera image to indicate vehicles approaching from the sides. ➤ Cross Traffic Monitor* P. 488	ON*¹/OFF

*1:Default Setting

■ Voice Control*

Customizable Features		Description	Selectable Settings
Voice Control Mode		Selects a mode of the voice portal screen. ➤ Voice Control Operation* , *1 P. 255	Assist/Normal*¹

*1:Default Setting

How to Customize the Vehicle Settings

With the power mode in ON, select **Vehicle Settings**, then select a setting item.

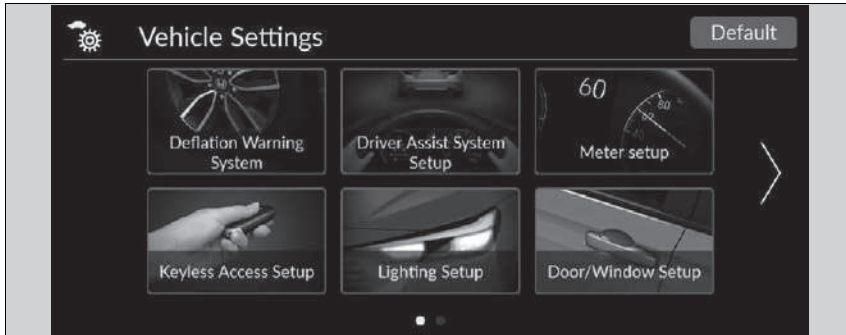

- **Deflation Warning System** ➤ P. 312
- **Driver Assist System Setup** ➤ P. 312
- **Meter setup** ➤ P. 314
- **Keyless Access Setup** ➤ P. 315
- **Lighting Setup** ➤ P. 315
- **Door/Window Setup** ➤ P. 316
- **Power tailgate setup*** ➤ P. 316
- **Maintenance Info.*** ➤ P. 316

* Not available on all models

Continued

How to Customize the Vehicle Settings

If **Vehicle Settings** is not displayed on the home screen, select **All Apps**. You can change the displayed icons on the home screen.

➤ **App Shortcut Function** P. 259

■ **Deflation Warning System**

Customizable Features	Description	Selectable Settings
Deflation Warning System	Cancels/Calibrates Deflation Warning System. ➤ Deflation Warning System P. 392	Calibrate/Cancel

■ **Driver Assist System Setup**

Customizable Features	Description	Selectable Settings
Preceding vehicle proximity warning distance	Selects distance for Forward Collision Warning audible and visual alerts. ➤ Collision Mitigation Braking System (CMBS) P. 405	Far/Normal*¹/Near
ACC vehicle ahead detected beep	Turns On/Off audible notification when vehicle has moved in/out of adaptive cruise control range. ➤ Adaptive Cruise Control (ACC) with Low Speed Follow P. 423	ON/OFF*¹
Road departure mitigation setting	Selects operating mode of the Road Departure Mitigation system. ➤ Road Departure Mitigation System P. 453	Early/Normal/Delayed*¹
Lane keep assist beep	Selects On/Off the LKAS alert for not detecting road lines. ➤ Lane Keeping Assist System (LKAS) P. 441	ON/OFF*¹

*1:Default Setting

Customizable Features	Description	Selectable Settings
Blind spot information*	Selects On/Off the blind spot information system audible alert. <input checked="" type="checkbox"/> Blind spot information System* P. 394	Audible and visual alert*¹/ Visual Alert Only
Traffic sign recognition system display	Displays the traffic sign recognition system on the instrument panel. <input checked="" type="checkbox"/> Traffic Sign Recognition System P. 461	Display*¹/None
Traffic sign recognition system over speed warning	Enables over speed limit warning when speed limit is exceeded. <input checked="" type="checkbox"/> Traffic Sign Recognition System P. 461	ON*¹/OFF

*1:Default Setting

* Not available on all models

■ Meter setup

Customizable Features	Description	Selectable Settings
Warning message	Selects whether to display the warning message. ➤ Driver Information Interface Warning and Information Messages P. 120	ON/OFF * ¹
Adjust outside temp. display	Selects to adjust outside temperature reading by a few degrees. ➤ Outside Temperature P. 133	-3°C ~ ±0°C * ¹ ~ +3°C
Trip A reset timing	Selects the timing to reset Trip A. ➤ Range / Fuel / Trip Meter P. 139 ➤ Speed & Time P. 141	When fully refueled/When ignition is turned OFF/Manual reset * ¹
Trip B reset timing	Selects the timing to reset Trip B. ➤ Range / Fuel / Trip Meter P. 139 ➤ Speed & Time P. 141	When fully refueled/When ignition is turned OFF/Manual reset * ¹
Alarm volume control	Changes volume level of all system warnings, door opening warning and indicator.	Max/Mid * ¹ / Min
Fuel efficiency backlight	Turns the ambient meter feature on and off.	ON * ¹ / OFF
Turn by turn display	Turns on/off the pop-up warning in the turn-by-turn navigation in the driver information interface. ➤ Turn-by-Turn Directions P. 143	ON * ¹ / OFF
Speed/distance units	Selects the trip computer units. ➤ Change Units P. 137	Left-hand drive type km/h · km * ¹ / mph · miles Right-hand drive type km/h · km / mph · miles * ¹
Rear seat reminder	Turns the Rear Seat Reminder feature on and off.	ON * ¹ / OFF

*1: Default Setting

■ **Keyless Access Setup**

Customizable Features	Description	Selectable Settings
Smart Entry Light Flash	Causes some exterior lights to flash when you unlock/lock the doors.	ON^{*1}/OFF

*1:Default Setting

■ **Lighting Setup**

Customizable Features	Description	Selectable Settings
Auto High Beam	Turns on/off auto high beam function.	ON^{*1}/OFF
Interior light dimmer duration	Selects the length of time the interior lights stay on after doors are closed. <input checked="" type="checkbox"/> Interior Lights P. 219	60sec/30sec^{*1}/15sec
Headlight auto OFF timer	Selects the length of time the exterior lights stay on after you close the driver's door. <input checked="" type="checkbox"/> Automatic Lighting Off Feature P. 186	60sec/30sec/15sec^{*1}/0sec
Headlight integration with wipers	Selects On/Off headlight function and wiper operation when the headlight is in AUTO setting. <input checked="" type="checkbox"/> Headlight Integration with Wipers P. 186	ON^{*1}/OFF

*1:Default Setting

■ Door/Window Setup

Customizable Features	Description	Selectable Settings
Keyless lock notification	Turns on/off flash of exterior lights when doors are locked/unlocked by remote. ▶ Using the Remote Transmitter P. 157	ON * ¹ / OFF
Auto Folding Door Mirror *	Selects door mirror auto folding operation.	ON * ¹ / OFF
Remote Window Control	Changes the settings for the remote window control function.	ON * ¹ / OFF

*1:Default Setting

■ Power tailgate setup*

Customizable Features	Description	Selectable Settings
Keyless open mode	Changes the keyless setting for when the power tailgate opens.	Anytime * ¹ / When unlocked
Power open by outer handle	Changes the setting to open power tailgate by tailgate outer handle.	ON (Power/Manual) * ¹ / OFF (Manual only)
Hands free access function *	Changes the setting to open power tailgate by a swift forward in and out kicking motion under the rear bumper.	ON * ¹ / OFF

*1:Default Setting

■ Maintenance Info.*

Customizable Features	Description	Selectable Settings
Maintenance Info.	Resets the maintenance information. ▶ Service Reminder System * P. 504	Selects Reset Items

* Not available on all models

Defaulting All the Settings

Reset all the menu and customized settings as the factory defaults.

■ Defaulting General Settings

1. Press the  button.
2. Select **General Settings**.
3. Select **System**.
4. Select **Factory Data Reset**.
 - ▶ A confirmation message appears on the screen.
5. Select **Continue** to reset the settings.
6. Select **Continue** again to reset the settings.
 - ▶ The system will reboot.

■ Defaulting Vehicle Settings

1. Press the  button.
2. Select **Vehicle Settings**.
3. Select **Default**.
4. Select **Yes**.

▣ Defaulting All the Settings

When you transfer the vehicle to a third party, reset all settings to default and delete all personal data.



If you perform **Factory Data Reset**, it will reset the preinstalled apps to their factory default.

Hands-Free Telephone System

Hands-Free Telephone (HFT) system allows you to place and receive phone calls using your vehicle's audio system, without handling your mobile phone.

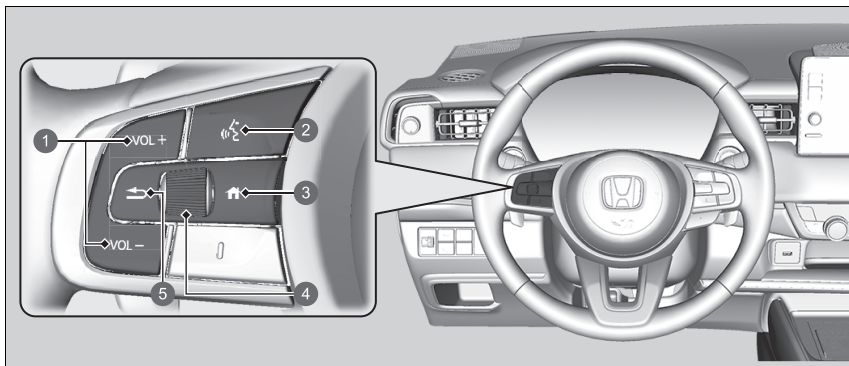
HFT Buttons



- 1 VOL + / VOL - (Volume) Buttons
- 2  (Talk) Button
- 3  (Home) Button
- 4 Left Selector Wheel
- 5  (Back) Button

Hands-Free Telephone System

Place your phone where you can get good reception.

To use HFT, you need a *Bluetooth*-compatible mobile phone. For a list of compatible phones, pairing procedures, and special feature capabilities, ask a dealer or your local Honda.

To use the system, the **Bluetooth** setting must be **ON**.

 **Phone Setup** P. 325

Voice control tips



- Aim the vents away from the ceiling and close the windows, as noise coming from them may interfere with the microphones.
- Press the  button when you want to call a number using a stored voice tag*, a phonebook name*, or a number*. Speak clearly and naturally after a beep.
- If the microphone picks up voices other than yours, the command may be misinterpreted.
- To change the volume level, the volume level is able to change by the audio system's volume.

If there is no Favourite contacts entry in the system, the pop-up notification appears on the screen.

 **Favourite Contacts** P. 330

 **(Talk) button:** Press to access Voice Portal* or call a number with a stored voice tag*.

 **(Home) button:** Press to go back to the home screen of the driver information interface.

Left Selector Wheel: Press the  (home) button, then roll up or down to select  (phone) on the driver information interface, and then press the left selector wheel.

While receiving a call, the incoming call screen is displayed on the driver information interface. You can pick up the call using the left selector wheel.

 **Receiving a Call** P. 335

 **(Back) button:** Press to go back to the previous screen or cancel a command.

Hands-Free Telephone System

Bluetooth[®] Wireless Technology

The *Bluetooth*[®] word mark and logos are registered trademarks owned by *Bluetooth* SIG, Inc., and any use of such marks by Honda Motor Co., Ltd., is under licence. Other trademarks and trade names are those of their respective owners.

HFT Limitations

An incoming call on HFT will interrupt the audio system when it is playing. It will resume when the call is ended.

■ HFT Status Display

The audio/information screen notifies you when there is an incoming call.

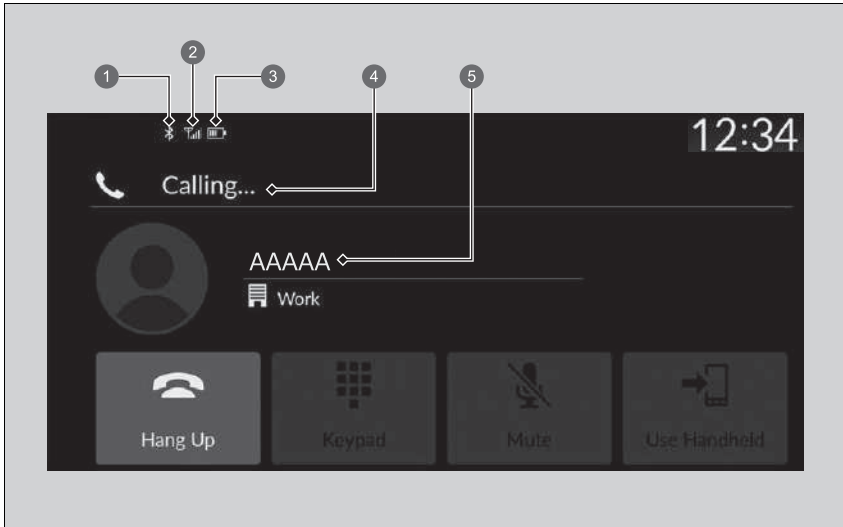

▣ HFT Status Display

The information that appears on the audio/information screen varies between phone models.

① *Bluetooth*® Indicator

Appears when your phone is connected to HFT.

② Signal Strength

③ Battery Level Status

④ HFT Mode

⑤ Caller's Name (If registered)/Caller's Number (If not registered)

■ Limitations for Manual Operation

Certain manual functions are disabled or inoperable while the vehicle is in motion. You cannot select a greyed-out option until the vehicle is stopped.

Only previously stored phonebook names*, numbers* or Favourite contacts with voice tags* can be called using voice commands while the vehicle is in motion.

📁 **Favourite Contacts** P. 330

■ HFT Menu

The power mode must be in ACCESSORY or ON to use the system. Select **Phone** to display the phone screen.

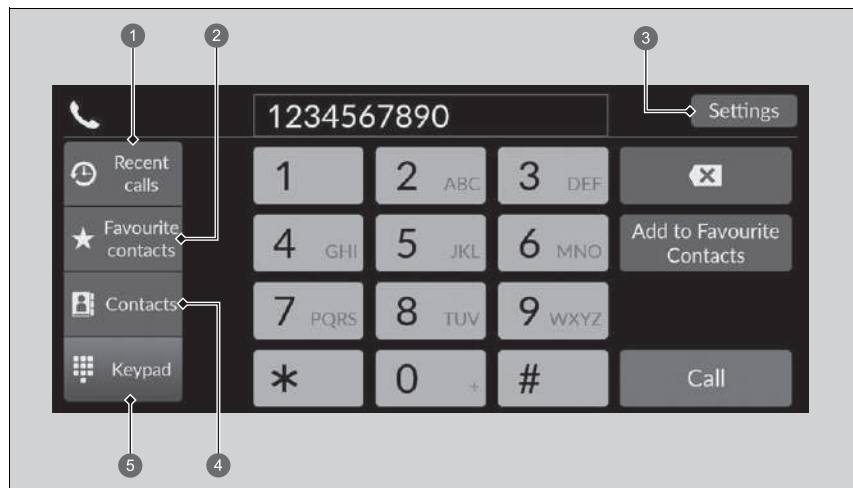

- ① Recent calls
- ② Favourite contacts
- ③ Settings
- ④ Contacts
- ⑤ Keypad

▶ HFT Menu

Some functions are limited while driving.

Recent calls: Displays the last outgoing, incoming, and missed calls.

☒ **To make a call using the recent calls** P. 333

Favourite contacts: Dials the selected number in the Favourite contacts entry.

☒ **To make a call using a Favourite contacts entry** P. 333

Settings: Changes the phone settings.

☒ **Phone Settings Screen** P. 324

Contacts: Displays the phonebook of the paired phone.

☒ **To make a call using the imported phonebook** P. 334

Keypad: Enters a phone number to dial.

☒ **To make a call using a phone number** P. 334

■ Phone Settings Screen

To display the phone settings screen, select **Settings** on the phone screen.

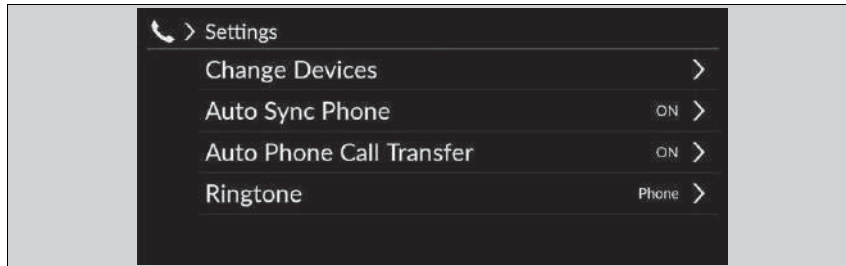

Change Devices: Pairs a new phone to the system and connect, disconnect, or delete a paired device.

➤ **Phone Setup** P. 325

Auto Sync Phone: Sets phonebook and recent calls data to be automatically imported when a phone is paired to HFT.

➤ **Automatic Import of Mobile Phonebook and Recent calls** P. 328

Auto Phone Call Transfer: Sets calls to automatically transfer from your phone to HFT when you enter the vehicle.

➤ **Automatic Transferring** P. 329

Ringtone: Selects the ring tone.

➤ **Ring Tone** P. 329

■ Phone Setup

■ **Bluetooth®** setup

You can turn *Bluetooth®* function on and off.

1. Press the  button.
2. Select **General Settings**.
3. Select **Connections**.
4. Select **Bluetooth**.
5. Select **Options**.
6. Select **Bluetooth**, then select **ON**.

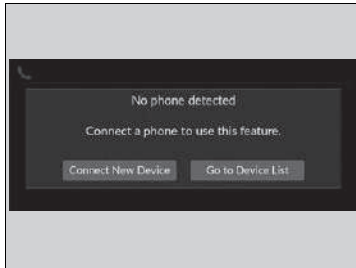

■ **To pair a mobile phone (when there is no phone paired to the system)**

1. Select **Phone**.
2. Select **Connect New Device**.
3. Make sure your phone is in search or discoverable mode.
4. Select **Honda HFT** from your phone.
 - ▶ If you want to pair a phone from this audio system, select **Search for Devices**, and then select your phone when it appears on the list.
5. The system gives you a pairing code on the audio/information screen.
 - ▶ Confirm if the pairing code on the screen and your phone match.
 - This may vary by a phone.
6. Select desired functions and then select **Connect**.
7. A notification appears on the screen if pairing is successful.
8. Select **OK**.



☞ Phone Setup

Your *Bluetooth*-compatible phone must be paired to the system before you can make and receive hands-free calls.

Phone Pairing Tips:

- You cannot pair your phone while the vehicle is moving.
- Up to six phones can be paired.
- Your phone's battery may drain faster when it is paired to the system.







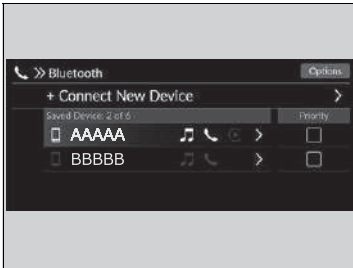

Once you have paired a phone, you can see it displayed on the screen with the following icons.

- : The phone is compatible with *Bluetooth*® Audio.
- : The phone can be used with HFT.
- : The phone is compatible with Apple CarPlay.

If there is an active connection to Apple CarPlay pairing of additional *Bluetooth*® compatible devices is unavailable.



■ **To change the currently paired phone**

1. Select **Phone**.
2. Select **Settings**.
3. Select **Change Devices**.
4. Select a phone to connect.
 - ▶ HFT disconnects the connected phone and starts searching for another paired phone.
 - ▶ You can set the connected phone priority. Select the box checked on the phone you want to prioritize.
5. Select  (audio),  (phone), or  (Apple CarPlay).
 - ▶  and  can be selected simultaneously, however, when  is selected,  and  cannot be selected.
6. Select **Apply**.



■ **To delete a paired phone**

1. Select **Phone**.
2. Select **Settings**.
3. Select **Change Devices**.
4. Select a phone you want to delete.
5. Select **Delete**.
6. A confirmation message appears on the screen. Select **Delete**.

▶▶ To change the currently paired phone

If no other phones are found or paired when trying to switch to another phone, HFT will inform you that the original phone is connected again.

To pair other phones, select + **Connect New Device** from the **Bluetooth** screen.

■ Automatic Import of Mobile Phonebook and Recent calls









When your phone is paired, the contents of its phonebook and recent calls are automatically imported to the system.

1. Select **Phone**.
2. Select **Settings**.
3. Select **Auto Sync Phone**.
4. Select **ON** or **OFF**.
 - ▶ The default setting is **ON**.

☒ Automatic Import of Mobile Phonebook and Recent calls

On some phones, it is necessary to set up it enabled to be imported the mobile phonebook.

When you select a name from the list in the mobile phonebook, you can see a category icon. The icons indicate what types of numbers are stored for that name.

	Pref		Fax
	Home		Car
	Mobile		Voice
	Work		Other
	Pager		

On some phones, it may not be possible to import the category icons to the system.

The phonebook is updated after every connection. Recent calls are updated after every connection or call.

■ Automatic Transferring

If you get into the vehicle while you are on the phone, the call can be automatically transferred to HFT.

1. Select **Phone**.
2. Select **Settings**.
3. Select **Auto Phone Call Transfer**.
4. Select **ON** or **OFF**.
 - ▶ The default setting is **ON**.

■ Ring Tone

You can change the ring tone setting.

1. Select **Phone**.
2. Select **Settings**.
3. Select **Ringtone**.
4. Select **Vehicle** or **Phone**.
 - ▶ The default setting is **Phone**.

☒ Ring Tone

Vehicle: The fixed ring tone sounds from the speakers.

Phone: Depending on the make and model of the mobile phone, the ring tone stored in the phone will sound if the phone is connected.

Favourite Contacts

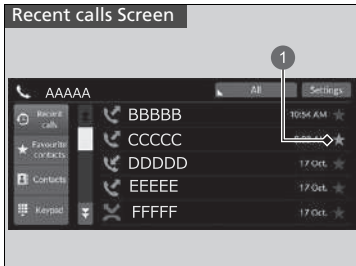

1 Star Icon

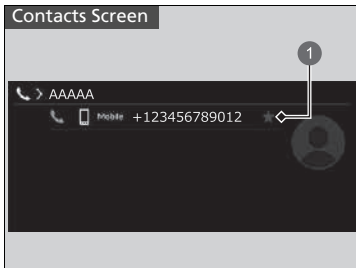

1 Star Icon

To add a Favourite contacts

1. Select **Phone**.
2. Select **Recent calls**, **Contacts**, or **Keypad**.

On the Recent calls or Contacts screen

3. Select the star icon.

On the Keypad screen

3. Select **Add to Favourite Contacts**.

- A notification appears on the screen if the Favourite contacts is successfully stored.
- To remove the Favourite contacts, select the star icon again.

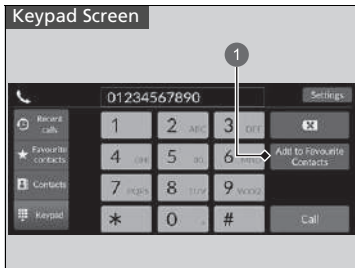

1 Add to Favourite Contacts

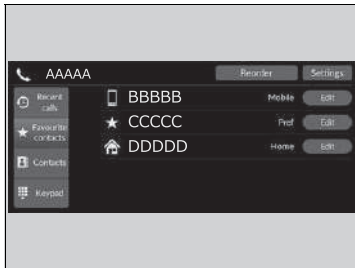

■ To edit a Favourite contacts

1. Select **Phone**.
2. Select **Favourite contacts**.
3. Select **Edit** on the Favourite contacts entry you want to edit.
4. Select a setting you want.
5. Select **Done**.

■ To delete a Favourite contacts

1. Select **Phone**.
2. Select **Favourite contacts**.
3. Select **Edit** on the Favourite contacts entry you want to delete.
4. Select **Remove**.
5. A confirmation message appears on the screen. Select **Yes**.

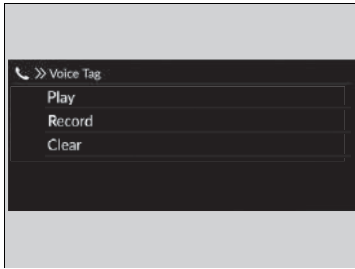

Models without voice control system

■ To add a voice tag to a stored Favourite contacts

1. Select **Phone**.
2. Select **Favourite contacts**.
3. Select **Edit** on the Favourite contacts entry you want to edit.
4. Select **Voice Tag**.
5. Select **Record**.
6. Select **Record**, or use the  button and follow the prompts to complete the voice tag.

Models without voice control system

■ To delete a voice tag

1. Select **Phone**.
2. Select **Favourite contacts**.
3. Select **Edit** on the Favourite contacts entry you want to edit.
4. Select **Voice Tag**.
5. Select **Clear**.
6. A confirmation message appears on the screen. Select **Yes**.

►► Favourite Contacts

Models without voice control system

Avoid using duplicate voice tags.
Avoid using "home" as a voice tag.
It is easier for the system to recognise a longer name.
For example, use "John Smith" instead of "John."

Making a Call



You can make calls by inputting any phone number, or by using the imported **Recent calls**, **Favourite contacts**, and **Contacts** entries.

■ To make a call using the recent calls

Recent calls are stored by **All**, **Dialled**, **Missed**, and **Received**.

1. Select **Phone**.
2. Select **Recent calls**.
 - ▶ You can sort by **All**, **Dialled**, **Missed**, or **Received**. Select the icon on the upper right of the screen.
3. Select a number.
 - ▶ Dialling starts automatically.

■ To make a call using a Favourite contacts entry

1. Select **Phone**.
2. Select **Favourite contacts**.
 - ▶ You can change the order of Favourite contacts entries by selecting **Reorder**.
3. Select a number.
 - ▶ Dialling starts automatically.

☞ Making a Call

Once a call is connected, you can hear the voice of the person you are calling through the audio speakers.

While there is an active connection with Apple CarPlay, phone calls cannot be made with Hands-Free Telephone (HFT) system and are only made from Apple CarPlay.

Models without voice control system

Any voice-tagged Favourite contacts entry can be dialled by voice from most screens. Press the  button and say the voice tag name.

☞ To make a call using the recent calls

The recent calls appear only when a phone is connected to the system.

All: Displays the last outgoing, incoming, and missed calls.

Dialled: Displays the last outgoing calls.

Missed: Displays the last missed calls.

Received: Displays the last incoming calls.

☞ To make a call using a Favourite contacts entry

Models without voice control system

When a voice tag is stored, press the  button to call the number using the voice tag.

➤ **Favourite Contacts** P. 330

Any voice-tagged Favourite contacts entry can be dialled by voice from any screen. Press the  button and follow the prompts.

Continued

■ To make a call using the imported phonebook

1. Select **Phone**.
2. Select **Contacts**.
3. Select a name.
 - ▶ You can sort by **First Name** or **Surname**. Select the icon on the upper right of the screen.
4. Select a number.
 - ▶ Dialling starts automatically.

■ To make a call using a phone number

1. Select **Phone**.
2. Select **Keypad**.
3. Select a number.
 - ▶ Use the keyboard on the touch screen for entering numbers.
4. Select **Call**.
 - ▶ Dialling starts automatically.

▶▶ To make a call using the imported phonebook

Models without voice control system

You can call a stored voice-tagged Favourite contacts using voice commands.

▶ **Favourite Contacts** P. 330

▶▶ To make a call using a phone number

Models without voice control system

You can call a stored voice-tagged Favourite contacts using voice commands.

▶ **Favourite Contacts** P. 330

Receiving a Call

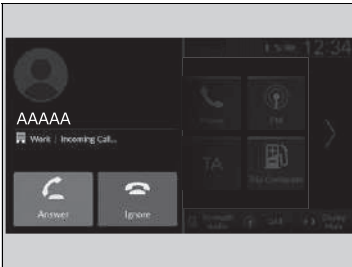

When there is an incoming call, an audible notification sounds (if activated) and the **Incoming Call...** screen appears.

You can answer the call using the left selector wheel.

To pick the call, roll up or down to select  (answer) on the driver information interface and then press the left selector wheel.

- ▶ If you want to decline or end the call, select  (ignore) on the driver information interface using the left selector wheel.

Receiving a Call



Call Waiting

Select  (answer) to put the current call on hold to answer the incoming call.

Select  using the left selector wheel to return to the current call.

Select  (ignore) to ignore the incoming call if you do not want to answer it.

Select  if you want to hang up the current call.

You can select the icons on the audio/information screen instead of  and  on the driver information interface.

Options During a Call

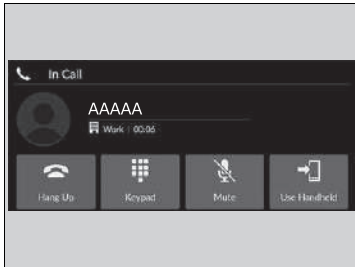

The following options are available during a call.

Keypad: Send numbers during a call. This is useful when you call a menu-driven phone system.

Mute: Mute your voice.

Use Handheld: Transfer a call from the system to your phone.

The available options are shown on the lower half of the screen.

Select the option.

- ▶ The mute icon appears when **Mute** is selected when the other source screen other than the phone screen is displayed. Select **Mute** again to turn it off.

Options During a Call

You can select the icons on the audio/information screen.

iPod/USB Flash Drive

If an error occurs while playing an iPod or USB flash drive, you may see the following error messages. If you cannot clear the error message, contact a dealer.

Error Message	Solution
No response from device	Appears when the system does not acknowledge the iPod. Reconnect the iPod.
Connect Retry	
Unplayable File	Appears when the files in the USB flash drive are copyright protected or an unsupported format. This error message appears for about five seconds, then plays the next song.
Unsupported Device	Appears when the system does not communicate with a connected device. If it appears when a device is connected, contact your place of device purchase.
A charging error has occurred with the connected USB device. When safe please check the compatibility of the device and USB cable and try again.	Appears when an incompatible device is connected. Disconnect the device. Then turn the audio system off, and turn it on again. Do not reconnect the device that caused the error.

Compatible iPod, iPhone, and USB Flash Drives

■ iPod and iPhone Model Compatibility

Model
Made for iPod touch (5th to 6th generation) released between 2012 and 2015
Made for iPhone 5/iPhone 5s/iPhone 5c/iPhone 6/iPhone 6 Plus/iPhone 6S/iPhone 6S Plus/iPhone SE/iPhone SE (2nd generation)/iPhone 7/iPhone 7 Plus/iPhone 8/iPhone 8 Plus/iPhone X/iPhone XS/iPhone XS Max/iPhone XR/iPhone 11/iPhone 11 Pro/iPhone 11 Pro Max/iPhone 12/iPhone 12 mini/iPhone 12 Pro/iPhone 12 Pro Max

■ USB Flash Drives

- A USB flash drive of 256 MB or higher is recommended.
- Some digital audio players may not be compatible.
- Some USB flash drives (e.g., a device with security lockout) may not work.
- Some software files may not allow for audio play or text data display.
- Each audio system is compatible the following formats. Some versions of the formats may be unsupported.
MP3, WMA, AAC, FLAC, PCM/WAVE, MP4, AVI, MKV, ASF/WMV

▶▶ iPod and iPhone Model Compatibility

This system may not work with all software versions of these devices.

▶▶ USB Flash Drives

Files on the USB flash drive are played in their stored order. This order may be different from the order displayed on your PC or device.

Recommended Devices

MP4 File

Media	USB Flash Drive	
Profile (MP4 version)	BaselineProfile/Level 3, MainProfile/Level 3.1 (MPEG4-AVC)	SimpleProfile/Level 5 (MPEG4)
File extension (MP4 version)	.mp4/.m4v	
Compatible audio codec	AAC, MP3	
Compatible video codec	MPEG4-AVC (H.264)	MPEG4 (ISO/IEC 14496 Part.2)
Bit rate	10 Mbps, 14 Mbps (MPEG4-AVC)	8 Mbps (MPEG4)
Maximum image	1,280 × 720 pixels (MPEG4-AVC)	720 × 576 pixels (MPEG4)

AVI File

Media	USB Flash Drive		
Profile (AVI version)	BaselineProfile/Level 3, MainProfile/Level 3.1 (MPEG4-AVC)	SimpleProfile/Level 5 (MPEG4)	AdvancedProfile/Level 2, MainProfile/Level Medium, SimpleProfile/Level Medium (VC-1)
File extension (AVI version)	.avi		
Compatible audio codec	AAC, MP3, WMA		
Compatible video codec	MPEG4-AVC (H.264)	MPEG4 (ISO/IEC 14496 Part.2)	VC-1
Bit rate	10 Mbps, 14 Mbps (MPEG4-AVC)	8 Mbps (MPEG4)	20 Mbps, 10 Mbps, 384 kbps (VC-1)
Maximum image	1,280 × 720 pixels (MPEG4-AVC)	720 × 576 pixels (MPEG4)	1,280 × 720 pixels, 720 × 480 pixels, 352 × 288 pixels (VC-1)

■ MKV File

Media		USB Flash Drive	
Profile (MKV version)	BaselineProfile/Level 3, MainProfile/Level 3.1 (MPEG4-AVC)	SimpleProfile/Level 5 (MPEG4)	AdvancedProfile/Level 2, MainProfile/Level Medium, SimpleProfile/Level Medium (VC-1)
File extension (MKV version)	.mkv		
Compatible audio codec	AAC, MP3		
Compatible video codec	MPEG4-AVC (H.264)	MPEG4 (ISO/IEC 14496 Part.2)	VC-1
Bit rate	10 Mbps, 14 Mbps (MPEG4-AVC)	8 Mbps (MPEG4)	20 Mbps, 10 Mbps, 384 kbps (VC-1)
Maximum image	1,280 × 720 pixels (MPEG4-AVC)	720 × 576 pixels (MPEG4)	1,280 × 720 pixels, 720 × 480 pixels, 352 × 288 pixels (VC-1)

■ ASF/WMV File

Media		USB Flash Drive	
Profile (ASF/WMV version)	BaselineProfile/Level 3, MainProfile/Level 3.1 (MPEG4-AVC)	AdvancedProfile/Level 2, MainProfile/Level Medium, SimpleProfile/Level Medium (VC-1)	
File extension (ASF/WMV version)	.asf/.wmv		
Compatible audio codec	WMA		
Compatible video codec	MPEG4-AVC (H.264)	VC-1	
Bit rate	10 Mbps, 14 Mbps (MPEG4-AVC)	20 Mbps, 10 Mbps, 384 kbps (VC-1)	
Maximum image	1,280 × 720 pixels (MPEG4-AVC)	1,280 × 720 pixels, 720 × 480 pixels, 352 × 288 pixels (VC-1)	

About Open Source Licences

To see the open source licence information, follow these steps.

1. Select **General Settings**.
2. Select **System**.
3. Select **Detail Information**.

■ Software for the Display Audio *

Copyright 2014 jQuery Foundation and other contributors
<http://jquery.com/>

Permission is hereby granted, free of charge, to any person obtaining a copy of this software and associated documentation files (the “Software”), to deal in the Software without restriction, including without limitation the rights to use, copy, modify, merge, publish, distribute, sublicense, and/or sell copies of the Software, and to permit persons to whom the Software is furnished to do so, subject to the following conditions:

The above copyright notice and this permission notice shall be included in all copies or substantial portions of the Software.

THE SOFTWARE IS PROVIDED “AS IS”, WITHOUT WARRANTY OF ANY KIND, EXPRESS OR IMPLIED, INCLUDING BUT NOT LIMITED TO THE WARRANTIES OF MERCHANTABILITY, FITNESS FOR A PARTICULAR PURPOSE AND NONINFRINGEMENT. IN NO EVENT SHALL THE AUTHORS OR COPYRIGHT HOLDERS BE LIABLE FOR ANY CLAIM, DAMAGES OR OTHER LIABILITY, WHETHER IN AN ACTION OF CONTRACT, TORT OR OTHERWISE, ARISING FROM, OUT OF OR IN CONNECTION WITH THE SOFTWARE OR THE USE OR OTHER DEALINGS IN THE SOFTWARE.

* Not available on all models

Legal Information on Apple CarPlay/Android Auto

■ OWNER'S MANUAL LICENSE/LIABILITY STATEMENTS

USE OF APPLE CARPLAY IS SUBJECT TO YOUR AGREEMENT TO THE CARPLAY TERMS OF USE, WHICH ARE INCLUDED AS PART OF THE APPLE iOS TERMS OF USE. IN SUMMARY, THE CARPLAY TERMS OF USE DISCLAIM APPLE AND ITS SERVICE PROVIDERS' LIABILITY IF THE SERVICES FAIL TO PERFORM CORRECTLY OR ARE DISCONTINUED, STRICTLY LIMIT APPLE AND ITS SERVICE PROVIDERS' OTHER LIABILITIES, DESCRIBE THE KINDS OF USER INFORMATION (INCLUDING, FOR EXAMPLE, VEHICLE LOCATION, VEHICLE SPEED, AND VEHICLE STATUS) BEING GATHERED AND STORED BY APPLE AND ITS SERVICE PROVIDERS, AND DISCLOSE CERTAIN POSSIBLE RISKS ASSOCIATED WITH THE USE OF CARPLAY, INCLUDING THE POTENTIAL FOR DRIVER DISTRACTION. SEE APPLE'S PRIVACY POLICY FOR DETAILS REGARDING APPLE'S USE AND HANDLING OF DATA UPLOADED BY CARPLAY.

USE OF ANDROID AUTO IS SUBJECT TO YOUR AGREEMENT TO THE ANDROID AUTO TERMS OF USE WHICH MUST BE AGREED TO WHEN THE ANDROID AUTO APPLICATION IS DOWNLOADED TO YOUR ANDROID PHONE. IN SUMMARY, THE ANDROID AUTO TERMS OF USE DISCLAIM GOOGLE AND ITS SERVICE PROVIDERS' LIABILITY IF THE SERVICES FAIL TO PERFORM CORRECTLY OR ARE DISCONTINUED, STRICTLY LIMIT GOOGLE AND ITS SERVICE PROVIDERS' OTHER LIABILITIES, DESCRIBE THE KINDS OF USER INFORMATION (INCLUDING, FOR EXAMPLE, VEHICLE LOCATION, VEHICLE SPEED, AND VEHICLE STATUS) BEING GATHERED AND STORED BY GOOGLE AND ITS SERVICE PROVIDERS, AND DISCLOSE CERTAIN POSSIBLE RISKS ASSOCIATED WITH THE USE OF ANDROID AUTO, INCLUDING THE POTENTIAL FOR DRIVER DISTRACTION. SEE GOOGLE'S PRIVACY POLICY FOR DETAILS REGARDING GOOGLE'S USE AND HANDLING OF DATA UPLOADED BY ANDROID AUTO.

DISCLAIMER OF WARRANTIES; LIMITATION ON LIABILITY

YOU EXPRESSLY ACKNOWLEDGE AND AGREE THAT USE OF APPLE CARPLAY OR ANDROID AUTO (“THE APPLICATIONS”) IS AT YOUR SOLE RISK AND THAT THE ENTIRE RISK AS TO SATISFACTORY QUALITY, PERFORMANCE, ACCURACY AND EFFORT IS WITH YOU TO THE MAXIMUM EXTENT PERMITTED BY APPLICABLE LAW, AND THAT THE APPLICATIONS AND INFORMATION ON THE APPLICATIONS IS PROVIDED “AS IS” AND “AS AVAILABLE,” WITH ALL FAULTS AND WITHOUT WARRANTY OF ANY KIND, AND HONDA HEREBY DISCLAIMS ALL WARRANTIES AND CONDITIONS WITH RESPECT TO THE APPLICATIONS AND INFORMATION ON THE APPLICATIONS, EITHER EXPRESS, IMPLIED OR STATUTORY, INCLUDING, BUT NOT LIMITED TO, THE IMPLIED WARRANTIES AND/OR CONDITIONS OF MERCHANTABILITY, SATISFACTORY QUALITY, FITNESS FOR A PARTICULAR PURPOSE, ACCURACY, QUIET ENJOYMENT, AND NON-INFRINGEMENT OF THIRD PARTY RIGHTS. NO ORAL OR WRITTEN INFORMATION OR ADVICE GIVEN BY HONDA OR AN AUTHORISED REPRESENTATIVE SHALL CREATE A WARRANTY. AS EXAMPLES, AND WITHOUT LIMITATION, HONDA DISCLAIMS ANY WARRANTY REGARDING THE ACCURACY OF DATA PROVIDED BY THE APPLICATIONS, SUCH AS THE ACCURACY OF DIRECTIONS, ESTIMATED TRAVEL TIME, SPEED LIMITS, ROAD CONDITIONS, NEWS, WEATHER, TRAFFIC, OR OTHER CONTENT PROVIDED BY APPLE, GOOGLE, THEIR AFFILIATES, OR THIRD PARTY PROVIDERS; HONDA DOES NOT GUARANTEE AGAINST LOSS OF APPLICATION DATA, WHICH MAY BE LOST AT ANY TIME; HONDA DOES NOT GUARANTEE THAT THE APPLICATIONS OR ANY SERVICES PROVIDED THROUGH THEM WILL BE PROVIDED AT ALL TIMES OR THAT ANY OR ALL SERVICES WILL BE AVAILABLE AT ANY PARTICULAR TIME OR LOCATION. FOR EXAMPLE, SERVICES MAY BE SUSPENDED OR INTERRUPTED WITHOUT NOTICE FOR REPAIR, MAINTENANCE, SECURITY FIXES, UPDATES, ETC., SERVICES MAY BE UNAVAILABLE IN YOUR AREA OR LOCATION, ETC. IN ADDITION, YOU UNDERSTAND THAT CHANGES IN THIRD PARTY TECHNOLOGY OR GOVERNMENT REGULATION MAY RENDER THE SERVICES AND/OR APPLICATIONS OBSOLETE AND/OR UNUSABLE.

TO THE EXTENT NOT PROHIBITED BY LAW, IN NO EVENT SHALL HONDA OR ITS AFFILIATES BE LIABLE FOR PERSONAL INJURY, OR ANY INCIDENTAL, SPECIAL, INDIRECT OR CONSEQUENTIAL DAMAGES WHATSOEVER, INCLUDING, WITHOUT LIMITATION, DAMAGES FOR LOSS OF PROFITS, CORRUPTION OR LOSS OF DATA, FAILURE TO TRANSMIT OR RECEIVE ANY DATA, BUSINESS INTERRUPTION OR ANY OTHER COMMERCIAL DAMAGES OR LOSSES, ARISING OUT OF OR RELATED TO THE APPLICATIONS OR YOUR USE OF OR INABILITY TO USE THE APPLICATIONS OR INFORMATION ON THE APPLICATIONS, HOWEVER CAUSED, REGARDLESS OF THE THEORY OF LIABILITY (CONTRACT, TORT OR OTHERWISE) AND EVEN IF HONDA WERE ADVISED OF THE POSSIBILITY OF SUCH DAMAGES. SOME REGIONS AND JURISDICTIONS MAY DISALLOW THE EXCLUSION OR LIMITATION OF LIABILITY FOR DAMAGES, SO THESE LIMITATIONS AND EXCLUSIONS MAY NOT APPLY TO YOU. THE FOREGOING LIMITATIONS WILL APPLY EVEN IF THE ABOVE STATED REMEDY FAILS OF ITS ESSENTIAL PURPOSE.

Automatic emergency call

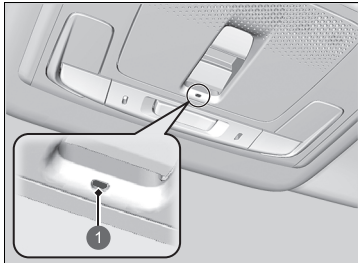

1 eCall Indicator

- Vehicle identification number (VIN)
- Type of vehicle (passenger vehicle or light-weight commercial vehicle)
- Type of energy stored for vehicle propulsion (gasoline/diesel/CNG/LPG/electricity/hydrogen)
- Last three locations of the vehicle
- Direction of travel
- Triggering mode (automatic or manual)
- Timestamp

When an emergency call is initiated, the vehicle speakers are disabled so that you can hear the operator.

When the power mode is set to ON, the eCall indicator lights up in green for 1 second, then in red for 1 second.

Emergency Call (eCall)

Your vehicle is equipped with the 112-based eCall service system.

The 112-based eCall service is a public service of general interest and is accessible free of charge.

The 112-based eCall in-vehicle system is activated when the power mode is set to ON. In the event of a collision, the system will determine the degree of the impact based on information collected from the on-board sensors and, depending on the severity of the collision, will initiate the emergency call.

The 112-based eCall in-vehicle system can also be triggered manually, if needed.

Manual emergency call P. 346

Any processing of personal data through the 112-based eCall in-vehicle system shall comply with the personal data protection rules provided for in Directives 95/46/EC (replaced by 2016/679/EC) and 2002/58/EC, and in particular, shall be based on the necessity to protect the vital interests of the individuals in accordance with Article 7(d) of Directive 95/46/EC (replaced by 2016/679/EC).

Processing of such data is strictly limited to the purpose of for which the single European emergency number 112 is designated.

If the eCall system is working properly, the indicator will light up in green.

- Green: eCall system is ready.
- Blinking in green: eCall system is connected and making an eCall to a PSAP operator.
- Repeating a pattern of short flashes of the red light: The eCall system has failed to connect to an operator. The eCall indicator will continue this pattern for 5 seconds*¹/30 seconds*², then it will light up in green.

If the 112-based eCall system is disabled in the event of a critical system failure, the following warning will be given to the occupants of the vehicle:

- Red or blacked out: A problem with the eCall system has occurred. If the indicator stays red or blacked out even after you have restarted the vehicle, have the system check by a dealer.
- Blinking in red: The level of the backup battery is too low. While the power is in ON, the battery undergoes recharging. Once the battery has been recharged to a certain level, the eCall indicator lights up in green.

*1: Except Turkish models

*2: Turkish models

☒ Emergency Call (eCall)

Recipients of data processed by the 112-based eCall in-vehicle system are the relevant public safety answering points designated by the respective public authorities of the country in which they are located and are the first to receive and for which the single European emergency number 112 is designated.

Your vehicle may NOT be able to connect to a PSAP operator if:

- both the 12V battery and backup battery are too low.
- your vehicle is in an area without adequate cellular coverage.
- There is a problem with the eCall system itself or its peripheral equipment such as the microphone or speakers.

The backup battery is designed to operate for at least 3 years, after which it may need to be replaced.

The backup battery is not available for direct purchase. For replacement, visit a dealer.

Manual emergency call

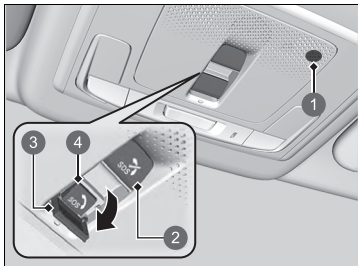

- ① Microphone
- ② **SOS** Cancel Button
- ③ Cover
- ④ **SOS** Button

The **SOS** button is protected by a cover. Open the cover to gain access.

When an emergency call is initiated, the vehicle speakers are disabled so that you can hear the operator.

Manual emergency call

Do NOT press the button while you are driving. If you need to contact an operator, park the vehicle in a safe place before you make a call.

If the eCall system at first fails to connect to a PSAP operator, it will try again until a connection is established. However, if 2 minutes have elapsed since the first try was attempted, the system will no longer attempt to establish a connection.

The **SOS** cancel button does not cancel a call once the system is connected to an operator.

☒ Emergency Call (eCall)

Data privacy

The 112-based eCall in-vehicle system is designed to ensure that:

- Data contained in the system memory is not available outside the system before an eCall is triggered.
- It is not traceable or subject to any constant tracking during its normal operation status.
- Data in the internal memory of the system is automatically and continuously removed.

For the system to function normally, the vehicle location data is constantly overwritten in the internal memory of the system so that the last three locations of the vehicle are kept up-to-date.

The log of activity data in the 112-based eCall in-vehicle system is kept for no longer than necessary for attaining the purpose of handling the emergency eCall and in any case not beyond 13 hours from the moment an emergency eCall was initiated.

» Emergency Call (eCall)

Owner's rights

The data subject (the vehicle's owner) has a right of access to data and as appropriate to request the rectification, erasure or blocking of data, concerning him or her, the processing of which does not comply with the provisions of Directive 95/46/EC (replaced by 2016/679/EC).

Any third parties to whom the data have been disclosed have to be notified of such rectification, erasure or blocking carried out in compliance with this Directive, unless it proves impossible or involves a disproportionate effort.

The data subject has a right to complain to the competent data protection authority if he or she considers that his or her rights have been infringed as a result of the processing of his or her personal data.

Honda eCall Service Information:

If you have any questions about eCall, contact the office relevant to the country in which you reside. See the service book or your local Honda website for a list of offices.

Your vehicle is equipped with a feature that automatically calculates when to refuel. This feature will notify you when refueling is recommended as well as enable you to search for petrol stations that are located in the vicinity of your vehicle.



1 Notification Icon

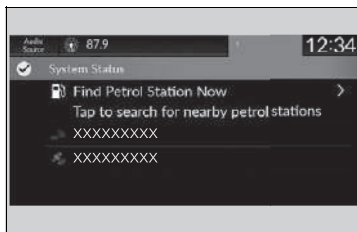

1. When it is time to refuel the vehicle, a notification is displayed and a notification icon is displayed in the header.
2. Touch the box that contains the icon.

3. Select **Find Petrol Station Now**.

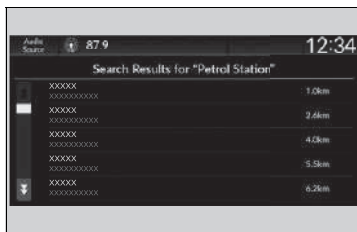

4. Choose a petrol station from the search screen of the navigation system.
 - ▶ For instructions on how to use the navigation system, refer to the navigation system manual.

Refuel Recommend

You can turn the **Refuel Recommend** function on and off.

▶ **Customized Features** P. 304

When you turn off this feature, the refuel recommend notification will not display.

This feature can only be used when the fuel level in the tank is below 30 percent.

If you select **Find Petrol Station Now** or put more than 5 litres of petrol into the fuel tank, the notification for refueling will disappear. If you prefer not to be notified, select **OFF** in the settings for **Refuel Recommend**.

When you drive on a rough road or ascend or descend a hill for an extended period of time, the notification may disappear or may not be displayed at all.

Driving

This chapter discusses driving and refueling.



Before Driving	352
Towing a Trailer	356
Off-road Guidelines	357
When Driving	
Turning on the Power	359
Precautions While Driving.....	362
Transmission	364
Shifting	365
Deceleration Paddle Selector	367
Acoustic Vehicle Alerting System.....	370
Drive Mode Switch.....	371
Hill Descent Control System	374
Adjustable Speed Limiter.....	376
Intelligent Speed Limiter.....	382

Vehicle Stability Assist (VSA) System.....	389
Agile Handling Assist	391
Deflation Warning System.....	392
Blind spot information System*	394
High Voltage Battery.....	399
Adjusting Headlight Distribution	400
Honda Sensing	402
Collision Mitigation Braking System (CMBS).....	405
Low Speed Braking Control.....	417
Adaptive Cruise Control (ACC) with Low Speed Follow	423
Lane Keeping Assist System (LKAS) ..	441
Road Departure Mitigation System....	453
Traffic Sign Recognition System	461

Front Wide View Camera.....	468
Sonar Sensors.....	470
Braking	
Brake System	471
Anti-lock Brake System (ABS).....	478
Brake Assist System	479
Emergency Stop Signal	480
Parking Your Vehicle	
When Stopped	481
Parking Sensor System	483
Cross Traffic Monitor*	488
Multi-View Rear Camera	493
Refueling	495
Fuel Economy and CO₂ Emissions	498

* Not available on all models

Driving Preparation

Check the following items before you start driving.

Exterior Checks

- Make sure there are no obstructions on the windows, door mirrors, exterior lights, or other parts of the vehicle.
 - ▶ Remove any frost, snow, or ice.
 - ▶ Remove any snow on the roof, as this can slip down and obstruct your field of vision while driving. If frozen solid, remove ice once it has softened.
 - ▶ When removing ice from around the wheels, be sure not to damage the wheel or wheel components.
- Make sure the bonnet is securely closed.
 - ▶ If the bonnet opens while driving, your front view will be blocked.
- Make sure the tyres are in good condition.
 - ▶ Check air pressures, and check for damage and excessive wear.
 - ✦ **Checking and Maintaining Tyres** P. 541
- Make sure there are no people or objects behind or around the vehicle.
 - ▶ There are blind spots from the inside.

Exterior Checks

NOTICE

When doors are frozen shut, use warm water around the door edges to melt any ice. Do not try to force them open, as this can damage the rubber trim around the doors. When done, wipe dry to avoid further freezing.

Do not pour warm water into the key cylinder. You will be unable to insert the key if the water freezes in the hole.

Heat from the engine and exhaust can ignite flammable materials left under the bonnet, causing a fire. If you've parked your vehicle for an extended period, inspect and remove any debris that may have collected, such as dried grass and leaves that have fallen or have been carried in for use as a nest by a small animal. Also, check under the bonnet for leftover flammable materials after you or someone else has performed maintenance on your vehicle.

Interior Checks

- Store or secure all items on board properly.
 - ▶ Carrying too much luggage, or improperly storing it, can affect your vehicle's handling, stability, stopping distance, and tyres, and make it unsafe.
 - **Load Limit** P. 355
- Do not pile items higher than the seat height.
 - ▶ They can block your view and may be thrown forward in the event of sudden braking.
- Do not place anything in the front seat footwells. Make sure to secure the floor mat.
 - ▶ An object or unsecured floor mat can interfere with your brake and accelerator pedal operation while driving.
- If you have any animals on board, do not let them move around in the vehicle.
 - ▶ They may interfere with driving and a crash could occur.
- Securely close all doors and the tailgate.
- Adjust your seating position properly.
 - ▶ Adjust the head restraint, too.
 - **Seats** P. 207
 - **Adjusting the Front Head Restraints** P. 215
- Adjust the mirrors and steering wheel properly.
 - ▶ Adjust them while sitting in the proper driving position.
 - **Mirrors** P. 203
 - **Adjusting the Steering Wheel** P. 202

Interior Checks

The headlight aim is set by the factory, and does not need to be adjusted. However, if you regularly carry heavy items in the luggage area, have the aiming readjusted at a dealer or by a qualified technician.

Models with headlight adjuster

You can adjust the low beam headlight angle by yourself.

➤ **Headlight Adjuster*** P. 192

Models without headlight adjuster

Your vehicle is equipped with the automatic headlight adjusting system that automatically adjusts the vertical angle of the low beam headlights.

* Not available on all models

- Be sure items placed on the floor behind the front seats cannot roll under the seats.
 - ▶ They can interfere with the driver's ability to operate the pedals, or the operation of the seats.
- Everyone in the vehicle must fasten their seat belt.
 - 📄 **Fastening a Seat Belt** P. 50
- Make sure that the indicators in the instrument panel come on when you start the vehicle, and go off soon after.
 - ▶ Always have a dealer check the vehicle if a problem is indicated.
 - 📄 **Indicators** P. 102

Load Limit

When you load luggage, the total weight of the vehicle, all passengers, and luggage must not exceed the maximum permissible weight.

📄 **Specifications** P. 610

The load for the front and rear axles also must not exceed the maximum permissible axle weight.

📄 **Specifications** P. 610

ⓘ Load Limit

⚠ WARNING

Overloading or improper loading can affect handling and stability and cause a crash in which you can be hurt or killed.

Follow all load limits and other loading guidelines in this manual.

Towing a Trailer

Your vehicle is not designed to tow a trailer. Attempting to do so can void your warranties.

General Information

Your vehicle has been designed primarily for use on pavement, however, its higher ground clearance allows you to occasionally travel on unpaved roads. It is not designed for trail-blazing, or other challenging off-road activities.

If you decide to drive on unpaved roads, you will find that it requires somewhat different driving skills and that your vehicle will handle somewhat differently than it does on pavement. Pay attention to the precautions and tips in this section, and get acquainted with your vehicle before leaving the pavement.

Important Safety Precautions

To avoid loss of control or rollover, be sure to follow all precautions and recommendations:

- Be sure to store luggage properly and do not exceed your luggage load limits.
 - **Load Limit** P. 355
- Whenever you drive, make sure you and your passengers always wear seat belts.
- Keep your speed low, and never go faster than the conditions allow.
- It's up to you to continually assess the situation and drive within the limits.

Off-road Guidelines

⚠ WARNING

Improperly operating this vehicle on or off pavement can cause a crash or rollover in which you and your passengers could be seriously injured or killed.

- Follow all instructions and guidelines in this owner's manual.
- Keep your speed low, and don't drive faster than conditions permit.

Failure to operate your vehicle correctly might result in a crash or a rollover.

- **Important Handling Information** P. 42
- **Precautions While Driving** P. 362

Avoiding Trouble

- **Check Out Your Vehicle** before you leave the pavement and make sure that all scheduled maintenance has been completed. Pay special attention to the condition of the tyres, and check the tyre pressures.
- **Remember** the route you choose presents limits (too steep or bumpy), you have limits (driving skill and comfort), and your vehicle has limits (traction, stability, and power). Failing to recognise these limits will likely put you and your passengers in a hazardous situation.
- **Accelerating and Braking** should be done slowly and gradually. Trying to start or stop too fast can cause a loss of traction and you could lose control.
- **Avoiding Obstacles and Debris** in the road reduces the likelihood of a rollover or damage to your suspension or other components.
- **Driving on Slopes** increases your risk of a rollover, particularly if you attempt to drive across a slope that is too steep. Going straight up or down a slope is usually the safest. If you can't clearly see all conditions or obstacles on a slope, walk it before you drive it. If there is any doubt whether you can safely pass, don't try it. Find another route. If you get stuck when climbing, do not try to turn around. Back down slowly following the same route you took up the hill.
- **Crossing a Stream** - Avoid driving through deep water. If you encounter water in your route (a small stream or large puddle, for example), evaluate it carefully before going ahead. Make sure it is shallow, flowing slowly, and has firm ground underneath. If you are not sure of the depth or the ground, turn around and find another route. Driving through deep water can also damage your vehicle. The water can get into the transmission and differential, diluting the lubricant and causing an eventual failure. It can also wash the grease out of the wheel bearings.
- **If You Get Stuck**, carefully go in the direction that you think will get you unstuck. Do not spin the tyres as this will only make things worse and could damage the transmission. If you are unable to free yourself, your vehicle will need to be towed. Front and rear tow hooks are provided for this purpose.

Turning on the Power

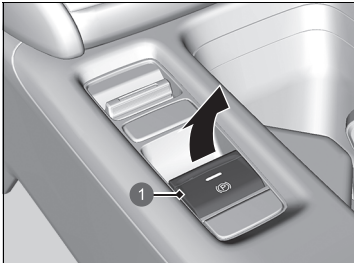

1 Electric Parking Brake Switch

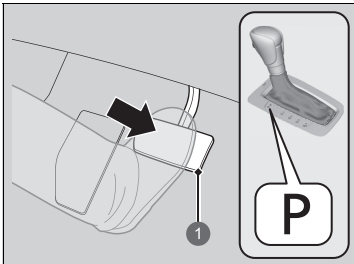

1 Brake Pedal

1. Make sure the parking brake is applied.
 - ▶ The parking brake and brake system indicator (red) comes on for 30 seconds when you pull up the electric parking brake switch.
2. Check that the transmission is in **P**, then depress the brake pedal.
 - ▶ Although it is possible to start the vehicle in **N**, it is safer to start it in **P**.

Turning on the Power

Keep your foot firmly on the brake pedal when starting the power system.

The engine is harder to start in cold weather and in thinner air found at altitudes above 2,400 metres (8,000 feet).

When turning on the power system in cold weather, turn off all electrical accessories such as the lights, climate control system, and rear demister in order to reduce the 12-volt battery drain.

If the exhaust system sounds abnormal or you can smell exhaust gas inside the vehicle, have your vehicle checked by a dealer. There may be a problem with the engine or exhaust system.





The immobilizer system protects your vehicle from theft.

If an improperly coded key (or other device) is used, the power system does not activate.

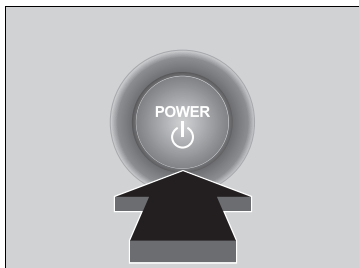
▶ **Immobilizer System** P. 174

When you set the power mode to ON, you may feel the brake pedal slightly sink down. This is normal.



3. Without depressing the accelerator pedal, press the **POWER** button while depressing the brake pedal.
4. Check the  (ready) indicator.
 - ▶ Keep depressing the brake pedal until the  indicator comes on.
 - ▶ The  indicator comes on when the power system is on and you can start driving.
 - ▶ If the outside temperature is extremely low, you cannot drive until conditions are improved. In this case, the  indicator does not come on and a warning message appears on the driver information interface.

❏ **Indicators** P. 102

❏ Turning on the Power

Bring the keyless remote close to the **POWER** button if the battery in the keyless remote is weak.

❏ **If the Keyless Remote Battery is Weak**
P. 584

The power system may not activate if the keyless remote is subjected to strong radio waves.

Do not hold the **POWER** button to start the power system.

If the power system does not start, wait at least 30 seconds before trying again.

The engine may not run when the vehicle is ready for driving.

You can start driving with the  indicator on.

If you press the **POWER** button while depressing the brake pedal with the  indicator on, the power mode is set to VEHICLE OFF and you cannot start driving.

❏ **Ready Indicator** P. 107

Starting to Drive

1. Keeping your right foot on the brake pedal, check that the  indicator is on, then put the transmission into **D**. Select **R** when reversing.
2. With the electric parking brake applied, release the brake pedal and gently depress the accelerator pedal.
 - ▶ Make sure the parking brake and brake system indicator (red) goes off.
 - 🔧 **Parking Brake** P. 471

Hill start assist system

Hill start assist keeps the brake engaged briefly to help to prevent the vehicle from rolling on inclines as you move your foot from the brake pedal to the accelerator. Put the transmission into **D**, **B** when facing uphill, or **R** when facing downhill, then release the brake pedal.

Stopping the Power System

You can turn the power system off when the vehicle is completely stopped.

1. Put the transmission into **P**.
2. Press the **POWER** button.

Starting to Drive

You can also release the parking brake by pressing the electric parking brake switch while depressing the brake pedal. When facing downhill, you can start your vehicle more smoothly by manually releasing it with the electric parking brake switch than by releasing it with the accelerator pedal.

As a hybrid vehicle, the sounds and vibrations from the engine may be absent even though the vehicle is ready for driving. It also makes you fail to recognise that you can start.

Make sure to check if the  indicator is on before you start to drive.

Hill start assist system

Hill start assist may not prevent the vehicle from rolling downhill on a very steep or slippery slope, and will not operate on small inclines.

Hill start assist is not a replacement for the parking brake.

Hill start assist will operate even when VSA is switched off.

Precautions While Driving

■ Driving Guidelines for Your Utility Vehicle

Utility vehicles have a significantly higher rollover rate than other types of vehicles. To prevent rollovers or loss of control:

- Take corners at slower speeds than you would with a passenger vehicle.
- Avoid sharp turns and abrupt manoeuvres whenever possible.
- Do not modify your vehicle in any way that you would raise the centre of gravity.

■ In a Fog

Visibility becomes low when it is foggy. When you drive, turn on the low beam headlights even during the daytime. Slow down, using the road line in the centre, guard rails, and the taillights of the vehicle ahead of you as your driving guide.

■ In a Strong Wind

If a strong side wind drifts your vehicle while driving, hold the steering wheel tight. Slowly decelerate your vehicle and keep your vehicle in the middle of the road. Be careful with wind gusts especially when your vehicle is exiting a tunnel, driving on a bridge or river bank, and driving through an open area like a quarry, and when a large lorry is passing by.

▶▶ Precautions While Driving

CAUTION: Do not drive on the road where water is deep. Driving through deep water will cause damage to the engine and electrical equipment and the vehicle will break down.

NOTICE

Do not operate the shift lever while pressing the accelerator pedal. You could damage the transmission.

NOTICE

If you repeatedly turn the steering wheel at an extremely low speed, or hold the steering wheel in the full left or right position for a while, the electric power steering (EPS) system heats up. The system goes into a protective mode, and limits its performance. The steering wheel becomes harder and harder to operate. Once the system cools down, the EPS system is restored. Repeated operation under these conditions can eventually damage the system.

If the power mode is set to ACCESSORY while driving, the power system will shut down and all steering and brake power assist functions will stop, making it difficult to control the vehicle.

Do not select **N** while driving as you will lose regenerative braking (and acceleration) performance.

■ In Rain

The road is slippery when raining. Avoid hard braking, rapid acceleration, and abrupt steering and be more cautious when driving. It is likely to experience hydroplaning phenomenon if you are driving on a rutted road with puddles. Do not drive in deep water and on flooded roads. This can damage the engine or driveline, or cause electrical component failure.

■ Other Precautions

If there is a strong impact with something under the vehicle, stop in a safe location. Check the underside of the vehicle for damage or any fluid leaks.

⌘ Precautions While Driving

During the first 1,000 km (625 miles) of operation, avoid sudden acceleration or full throttle operation so as not to damage the engine or powertrain.

Avoid hard braking for the first 300 km (200 miles) after purchasing your new vehicle or replacing the brake pads or rotors, to allow for proper break-in.

⌘ Driving Guidelines for Your Utility Vehicle

Failure to operate your vehicle correctly might result in a crash or a rollover.

- **Important Handling Information** P. 42
- **Precautions While Driving** P. 362

⌘ In Rain

Be careful when hydroplaning phenomenon occurs. When you drive on a road covered with water at excessive speed, a layer of water builds between the tyres and the road surface. If this occurs, the vehicle cannot respond to control inputs such as steering, and braking.

Slowly decelerate when you shift down. If the road is slippery, sudden regenerative braking can cause the tyres to skid.

Transmission

■ Creeping

As with a conventional petrol-powered vehicle with an automatic transmission, this vehicle will creep.

Keep the brake pedal firmly depressed when stopped.

■ Kickdown

Quickly depressing the accelerator pedal while driving uphill may cause the vehicle to react similar to an automatic transmission vehicle, unexpectedly increasing vehicle speed. Depress the accelerator pedal carefully, especially on slippery roads and curves.

Shifting

Change the shift position in accordance with your driving needs.

■ Shift positions

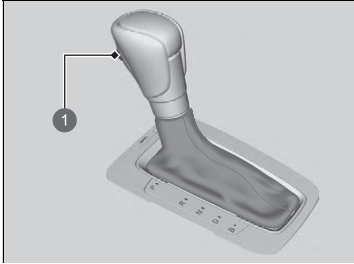

1 Release Button

P Park

Used when parking or turning the power on or off.

R Reverse

Used when reversing.

N Neutral

Transmission is not locked.

D Drive

Used for normal driving.

- The deceleration paddle selector can be used temporarily.
- The deceleration paddle selector can be used when **SPORT** mode is on.

B Drive (B)

- Used when driving down a long hill and to increase regenerative braking.
- The deceleration paddle selector can be used.

▶▶ Shifting

⚠ WARNING

The vehicle can roll away if left unattended without confirming that Park is engaged. A vehicle that rolls away could cause a crash resulting in serious injury or death. Always keep your foot on the brake pedal until you have confirmed that **P** is shown on the shift position indicator.

While the High Voltage battery level is full, or the High Voltage battery temperature is low, regenerative braking may become less effective.

The beeper sounds and the message appears on the driver information interface when you depress the accelerator pedal with the shift position in **N**.

▶ Driver Information Interface Warning and Information Messages P. 120

Change the shift position to **D** or **R** with the brake pedal depressed.

You cannot change the power mode from ON to VEHICLE OFF unless the shift lever is in **P**.

You may occasionally find that it takes longer than usual for the vehicle to start moving when you select **R**, release the brake pedal, and/or depress the accelerator pedal. This may occur when the High Voltage battery level is extremely low, and does not indicate a vehicle malfunction.

■ Shift Operation

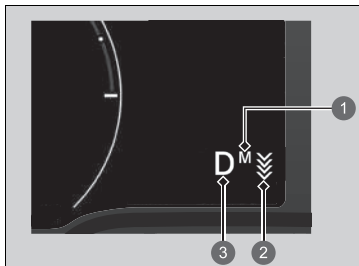

- ① M Indicator
- ② Deceleration Paddle Selector Indicator
- ③ Shift Position Indicator (Transmission System Indicator)

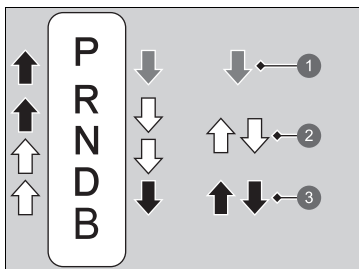

- ① Depress the brake pedal and press the shift lever release button to shift.
- ② Shift without pressing the shift lever release button.
- ③ Press the shift lever release button and shift.

▶ Shift Operation

NOTICE

When you change [D] to [R] and vice versa, come to a complete stop and keep the brake pedal depressed. Operating the shift position before the vehicle has come to a complete standstill can damage the transmission.

Use the shift position indicator to check the lever position before pulling away.

If the indicator of the currently selected shift position is blinking simultaneously, there is a problem with the transmission.

Avoid sudden acceleration and have the transmission checked by a dealer as soon as possible.

When shifting positions in extremely low temperatures -30°C , there may be a short delay before the shift position is displayed. Always confirm you are in the correct shift position before driving.

It may not be possible to operate the shift lever if the brake pedal is applied while the shift lever release button is held down.

Depress the brake pedal first.

Deceleration Paddle Selector

When you release the accelerator pedal, you can control the rate of deceleration without removing your hands from the steering wheel. Using the deceleration paddle selector situated on the steering wheel, you can sequentially shift through four stages of deceleration.

When descending a hill, you can use the deceleration paddle selector to help maintain the rate of deceleration, thereby allowing you to keep a safe distance between your vehicle and the vehicle ahead.

Deceleration Paddle Selector Operation

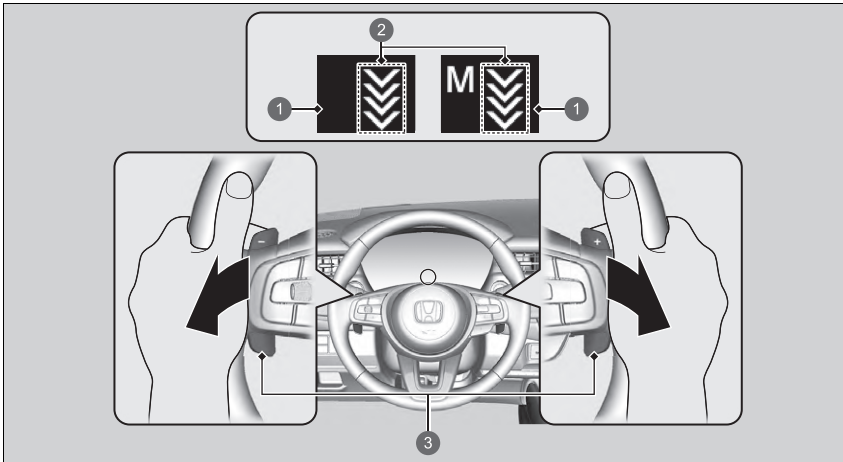

- ❶ Deceleration Paddle Selector Indicator
- ❷ Deceleration Stage
- ❸ Paddle Selector

Deceleration Paddle Selector

CAUTION

Rapidly increasing the deceleration rate by quickly shifting the deceleration paddle selector can cause the tyres to skid, resulting in a crash that could injure or kill someone.

Always maintain a reasonable rate of deceleration.

■ When the shift position is in **D**

If you pull back the paddle selector, the rate of deceleration will increase temporarily, and the stage will appear on the gauge.

The deceleration paddle selector will cancel automatically and the deceleration paddle selector indicator on the gauge will disappear when you drive at a constant speed or slow to a near stop.

■ When the shift position is in **D** and drive mode is **SPORT**

If you choose **SPORT** mode, the rate of deceleration will increase and the stage along with **M** will appear.

When you want to cancel the deceleration paddle selector, change out of **SPORT** mode. When cancelled, the deceleration paddle selector indicator on the gauge disappears.

■ When the shift position is in **B**

If you change the shift position to **B**, the rate of deceleration will increase and the stage along with **M** will appear.

When you want to cancel the deceleration paddle selector, change the shift position to **D** and change out of **SPORT** mode. When cancelled, the deceleration paddle selector indicator on the gauge disappears.

» Deceleration Paddle Selector

In the following situations, the stage may not change and the stage icon will blink even if you pull back the selector. The deceleration stage may decrease or cancel automatically when:



- The High Voltage battery is fully charged or its temperature is too cold or too hot.
- The speed of the vehicle is beyond the deceleration range with **SPORT** mode off.
- Hybrid system protection is needed.

You cannot use the deceleration paddle selector when **ACC** with **Low Speed Follow** is in operation. If either paddle selector is operated while driving, **ACC** with **Low Speed Follow** will cancel automatically.

If you pull back the right and left paddle selector at the same time, the deceleration stage may not change.

■ Common operations

To select the different stages of deceleration:

- Pull back the  selector (right side) to decrease the deceleration stage.
- Pull back the  selector (left side) to increase the deceleration stage.

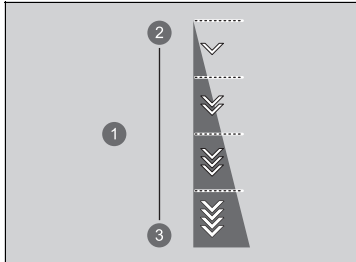

Each paddle selector operation makes a single stage deceleration change.

- ▶ The deceleration stage may not change if you keep the paddle selector pulled back.

- ① Deceleration Stage
- ② Decrease
- ③ Increase

Acoustic Vehicle Alerting System

Alerts pedestrians when a vehicle is propelled solely by electricity, approaching at speeds around 25 km/h (16 mph) or less.

Drive Mode Switch

Continuously controls your vehicle's driving performance according to the mode you select.

You can choose between three modes, **SPORT** mode, **NORMAL** mode and **ECON** mode, by moving the drive mode switch forward or back.

The currently selected mode is displayed on the driver information interface, and the display will change for each mode.

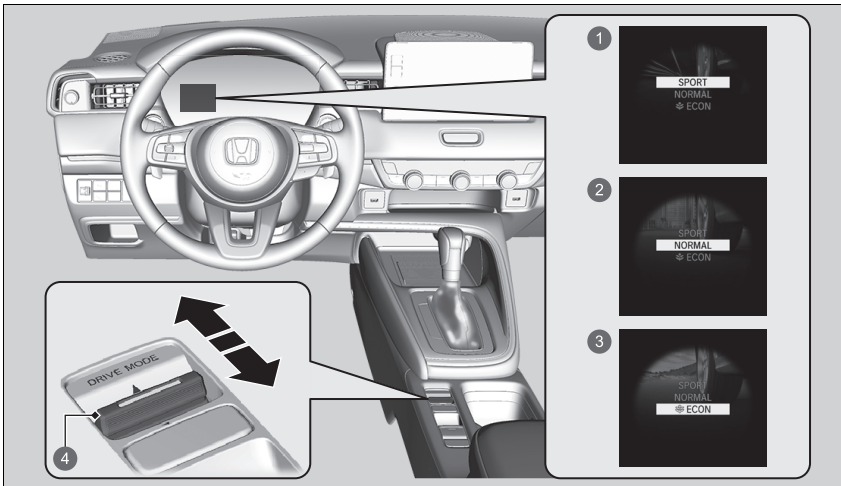

- ① **SPORT** Mode
- ② **NORMAL** Mode
- ③ **ECON** Mode
- ④ Drive Mode Switch

Drive Mode Switch

NORMAL mode is selected automatically every time you set the power mode to ON. However, if **ECON** mode was selected the last time you drove the vehicle, **ECON** mode will be selected when the power mode is set to ON.

The mode may not be able to be changed under some driving conditions. If there is a vehicle system failure, the following message will also appear on the driver information interface, and you cannot select any other mode.

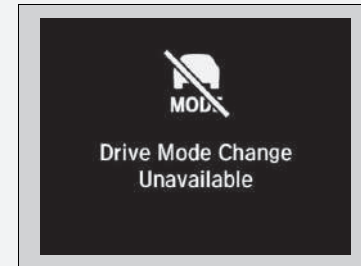

■ SPORT Mode

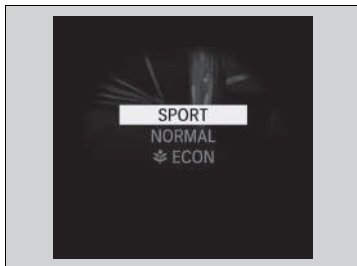

This mode enhances the responsiveness of the acceleration.

■ NORMAL Mode

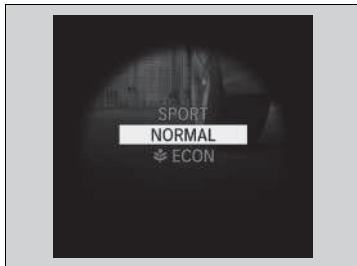

This mode optimizes the balance between operability and comfort.

ECON Mode

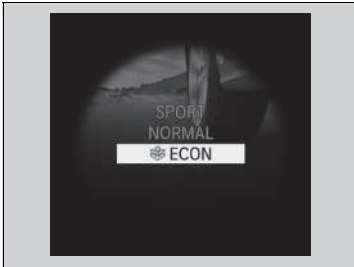

This mode facilitates fuel-efficient driving.

ECON Mode

While in **ECON** mode, the climate control system will be less effective and the vehicle slower to accelerate.

Hill Descent Control System

When driving down hills where engine braking is not enough to decelerate the vehicle, this system helps maintain a constant vehicle speed without needing to depress the brake pedal.

Hill Descent Control Operating Conditions

The system operates under the following conditions.

- Driving at a speed between about 3-20 km/h (2-12 mph).
- Driving downhill.
- Accelerator pedal and brake pedal are not depressed.

Driver information interface display

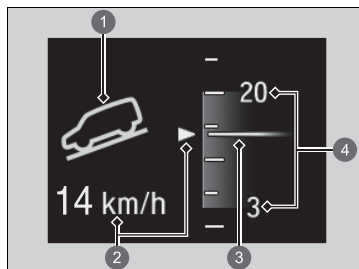

- 1 The system's operating status
 - Green: Activated
 - White: Standby
- 2 Vehicle speed display
 - White: Set speed
 - Grey: Current speed
 - ▶ Blinks when the vehicle speed is above the operating speed.
- 3 Current speed
- 4 Operating range of set speed

Hill Descent Control System

⚠ WARNING

Hill descent control cannot maintain a constant vehicle speed in every situation.

When driving down a very steep hill or on slippery road surfaces, the vehicle may not be able to maintain the vehicle speed and could cause a crash, resulting in serious injury or death.

Since Hill Descent Control is not designed to increase the limits of vehicle performance, the driver must always be aware of road surface conditions and drive safely.

The brake lights automatically come on while the system is in operation.

The system may not operate when driving down a gentle slope. Check the Hill Descent Control indicator to see if the system is in operation.

The system may activate even when not driving downhill, such as when the vehicle leans while driving over uneven surfaces.

■ How to Operate Hill Descent Control

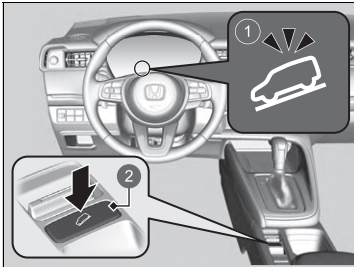

- ① Hill Descent Control Indicator
- ②  (Hill Descent Control) Button

■ To turn the system on

When the vehicle speed is less than about 20 km/h (12 mph), press the  button to turn the system on.

- ▶ The system goes into standby mode, and the Hill Descent Control indicator (white) comes on.

When all the working conditions are met, the system activates, and the vehicle begins to maintain the vehicle speed when driving downhill.

- ▶ The Hill Descent Control indicator (green) comes on when operating.

■ To adjust the set speed

Depress the accelerator pedal or brake pedal to adjust the vehicle speed within the operating range. The vehicle speed at which you release the accelerator pedal or brake pedal will be the set speed.

■ To turn the system off

Press the  button to turn the system off.

⌘ How to Operate Hill Descent Control

Using the system repeatedly for a long time may cause the brakes to heat up and make the system go into standby mode temporarily.

Hill Descent Control is turned off every time you turn the power system off, even if it was turned on the last time you drove the vehicle.

The pedals may vibrate or you may hear the system working when in operation.

⌘ To turn the system off

When the vehicle speed is 60 km/h (37 mph) or more, the system turns off automatically.

Adjustable Speed Limiter

This system enables you to set a maximum speed that cannot be exceeded even if you are depressing the accelerator pedal.

The vehicle speed limit can be set from about 30 km/h (18 mph) to about 250 km/h (156 mph).

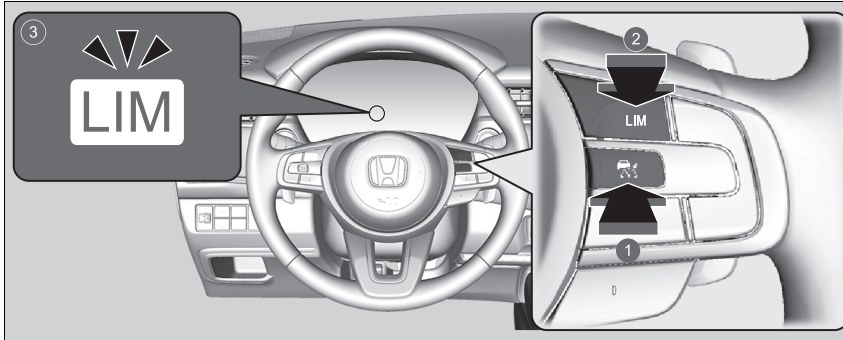

- 1 Press the  button on the steering wheel.
- 2 If a different indicator comes on, press the **LIM** button to switch to the adjustable speed limiter.
- 3 **The Adjustable Speed Limiter Indicator (White) is on in the gauge.**
Adjustable speed limiter is ready to use.

Adjustable Speed Limiter

WARNING

Adjustable Speed Limiter has limitations. It is always your responsibility to adjust the vehicle speed to obey the actual speed limit, and safely operate the vehicle.

WARNING

Do not depress the accelerator pedal more than necessary. Maintain an appropriate accelerator pedal position depending on the vehicle speed.

The adjustable speed limiter may not hold the set speed limit when driving downhill. If this occurs, slow down by depressing the brake pedal.

When not using the adjustable speed limiter:
Turn off the adjustable speed limiter by pressing the  button.

You cannot use the Adjustable Speed Limiter and below systems at the same time.
-Adaptive cruise control (ACC) with low speed follow
-Intelligent speed limiter

■ To Set the Speed Limit

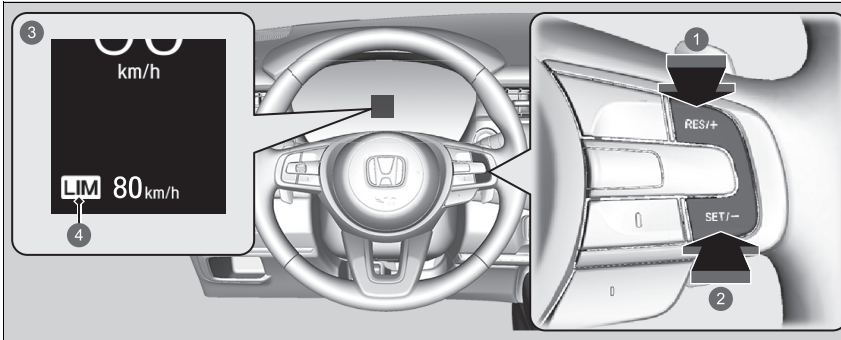

- ① **RES/+** Button
- ② **SET/-** Button
- ③ On when the adjustable speed limiter is set.
- ④ Adjustable Speed Limiter Indicator (Green)

- Take your foot off the pedal and press the **SET/-** button when you reach the desired speed.
The moment you release the **SET/-** button, the speed limit is fixed, and the adjustable speed limiter is set. The speed limit is displayed.
- You can set the previously set speed limit by pressing the **RES/+** button.

☒ To Set the Speed Limit

If you set the speed limit while travelling at less than 30 km/h (18 mph), the speed limit is set to 30 km/h (18 mph).

The beeper sounds and the displayed speed limit blinks if the vehicle speed exceeds the limit by 3 km/h (2 mph) or more on a steep descent.

The adjustable speed limiter is set to the current speed if it is higher than the previously set speed limit when you press the **RES/+** button.

You can switch the displayed set speed measurements between km/h and mph on the audio/information screen.

☒ **Customized Features** P. 304

■ To Adjust the Speed Limit

Increase or decrease the speed limit by using the **RES/+** or **SET/-** buttons on the steering wheel.

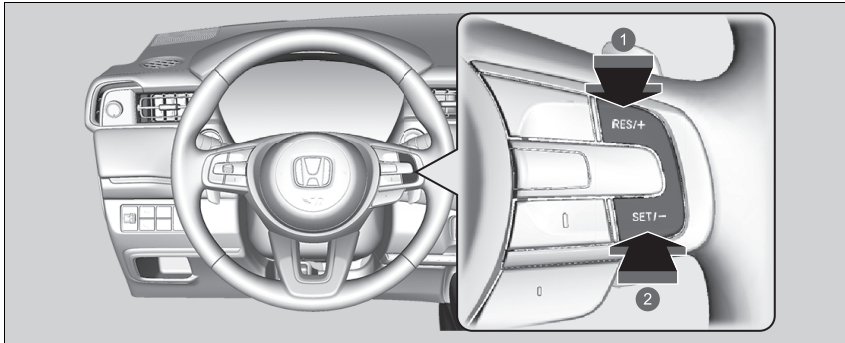

- 1 To increase speed
- 2 To decrease speed

- Each time you press the button, the speed limit increases or decreases by 1 km/h or 1 mph accordingly.
- If you keep the button pressed, the speed limit increases or decreases in increments of 10 km/h or 10 mph every 0.5 second until system limit is reached.
- The vehicle may accelerate or decelerate until the set speed is reached.

■ Exceeding the Speed Limit Temporarily

The speed limit can be exceeded by depressing the accelerator pedal completely.

- ▶ The displayed limit speed blinks.
- ▶ The beeper sounds once the speed limit has been exceeded.

☒ Exceeding the Speed Limit Temporarily

The beeper sounds when the vehicle speed goes higher than the set speed limit with the accelerator pedal depressed completely.

The adjustable speed limiter resumes working once the vehicle speed goes lower than the set speed limit.

Continued

■ To Cancel

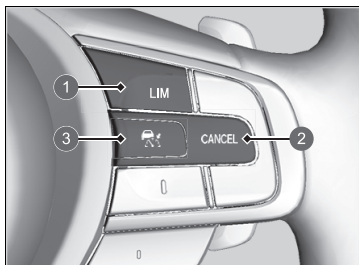

- ① LIM Button
- ② CANCEL Button
- ③  Button

To cancel the adjustable speed limiter, do any of the following:

- Press the **CANCEL** button.
- Press the  button.
- Press the **LIM** button.

▶▶ To Cancel

The adjustable speed limiter changes into adaptive cruise control (ACC) with Low Speed Follow or intelligent speed limiter if the **LIM** button is pressed.

Resuming the prior set speed:
Press the **CANCEL** button to display the prior set speed (gray) and press the **RES/+** button to resume the prior set speed.
If you are driving at a speed faster than the prior set speed (gray), the adjustable speed limiter is set to the displayed speed by pressing the **RES/+** button.
If you press the **RES/+** button when no prior set speed (in gray) is displayed, the speed will be set to your vehicle's current speed.

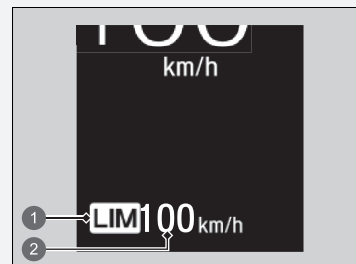

- ① Adjustable Speed Limiter Indicator (White)
- ② Prior Set Speed (Gray)

▶▶To Cancel

If there is a problem with the system when you are using the adjustable speed limiter, the beeper sounds and **OFF** comes on. The adjustable speed limiter will be turned off.

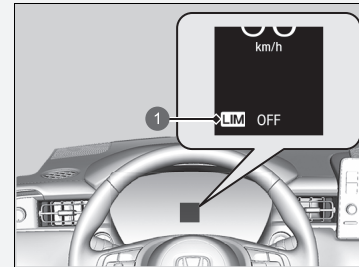

- 1 Adjustable Speed Limiter Indicator (White)

Intelligent Speed Limiter

Automatically sets the speed limit that the traffic sign recognition system detects. And the speed limit cannot be exceeded even if you are depressing the accelerator pedal. If you fully depress the accelerator the speed limit can be exceeded.

➤ **Traffic Sign Recognition System** P. 461

Intelligent Speed Limiter

WARNING

Intelligent Speed Limiter has limitations. The Intelligent Speed Limiter may set itself to a speed above or below the actual speed limit, or may not work, particularly where the traffic sign recognition system does not operate correctly or where a road has no speed limit signs. It is always your responsibility to adjust the speed to obey the actual speed limit and to safely operate the vehicle.

Depending on the amount of depression of the accelerator pedal, the vehicle will accelerate until it reaches the speed identified by the traffic sign recognition system.

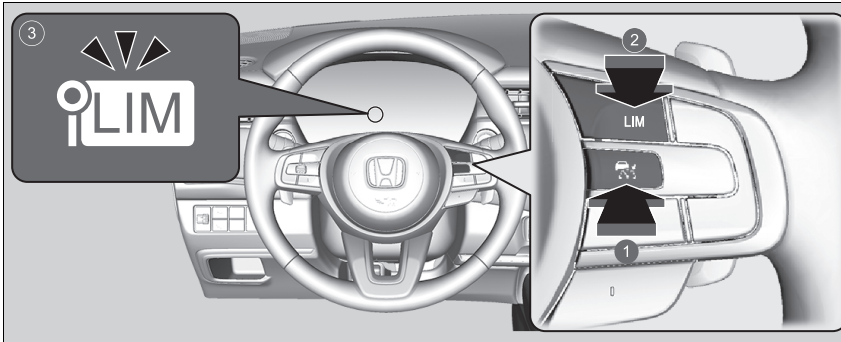

- ❶ Press the  button on the steering wheel.
- ❷ If a different indicator comes on, press the **LIM** button to change it to the intelligent speed limiter.
- ❸ **The Intelligent Speed Limiter Indicator (White) is on in the gauge.**
Intelligent speed limiter is ready to use.

▶ Intelligent Speed Limiter

The system is designed to detect signs that follow the Vienna Convention standards. Not all signs may be detected, but any signs posted on roadsides should not be ignored. The system does not work on the designated traffic signs of all the countries you travel, nor in all situations.

▶ Traffic Sign Recognition System P. 461

If the intelligent speed limiter is set to the wrong speed limit, try one of the following:

To cancel

- Press the **CANCEL** button.
- Press the  button.
- Press the **LIM** button.

To exceed the speed limit temporarily

- Depressing the accelerator pedal fully.

The intelligent speed limiter may not hold the set speed limit when driving downhill. If this occurs, slow down by depressing the brake pedal.

When not using the intelligent speed limiter, turn off the intelligent speed limiter by pressing the  button.

You cannot use the intelligent speed limiter and adaptive cruise control (ACC) with Low Speed Follow or adjustable speed limiter at the same time.

■ To Set the Speed Limit

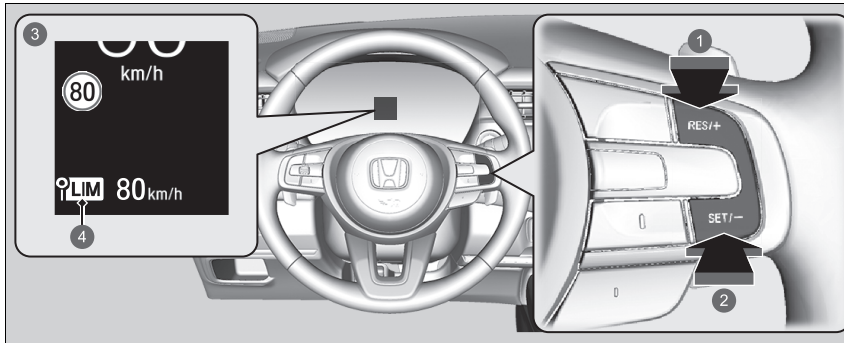

- 1 **RES/+** Button
 - 2 **SET/-** Button
 - 3 On when the intelligent speed limiter is set to the speed limit that the traffic sign recognition system detects.
 - 4 Intelligent Speed Limiter Indicator (Green)
- The moment you release the **SET/-** button or **RES/+** button, the intelligent speed limiter is set to the speed limit that the traffic sign recognition system detects. The speed limit is displayed.

▶ Intelligent Speed Limiter

Do not use the intelligent speed limiter in areas of different units from the display unit of the intelligent speed limiter.

Change the displayed measurement of the set vehicle speed to the same units as the driving areas.

▶ **Customized Features** P. 304

▶ To Set the Speed Limit

If you set the intelligent speed limiter when the speed limit that the traffic sign recognition system detects is less than 30 km/h (20 mph), the speed limitation function and warning function may switch to pause.

If your vehicle speed is higher than the speed limit that the traffic sign recognition system detects, your vehicle decelerates slowly to the speed limit or less. If necessary, slow down by depressing the brake pedal. And the beeper sounds and the displayed speed limit blinks if the vehicle speed exceeds the limit by 3 km/h (2 mph) or more.

■ **When the traffic sign recognition system detects the new speed limit sign**

The intelligent speed limiter is set to the new speed limit that the traffic sign recognition system detects.

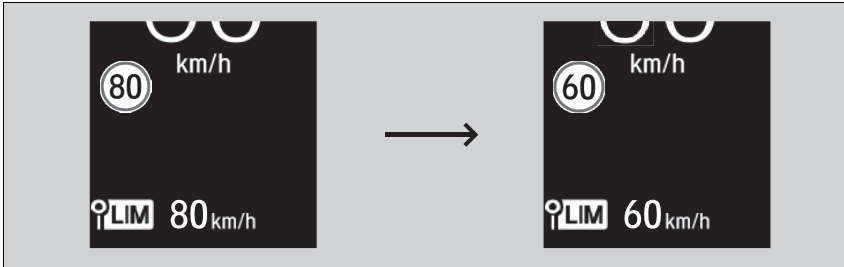

■ **The speed limitation function and warning function may switch to pause if there is no speed limit sign in the screen of the traffic sign recognition system when:**

- The end of speed limit or other designated limit is detected.
- Your vehicle enters/exits motorway or highway.
- You make a turn with a turn signal to change direction at an intersection.



▶▶ To Set the Speed Limit

The intelligent speed limiter may also switch to pause when the traffic sign recognition system detects only additional speed limit signs.

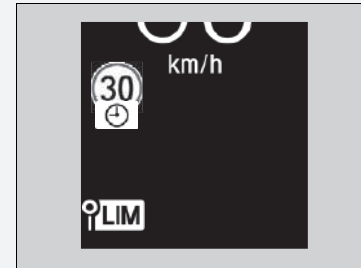

■ **When the traffic sign recognition system detects the speed limit sign while the intelligent speed limiter is paused**

The speed limitation function and warning function will be resumed automatically.

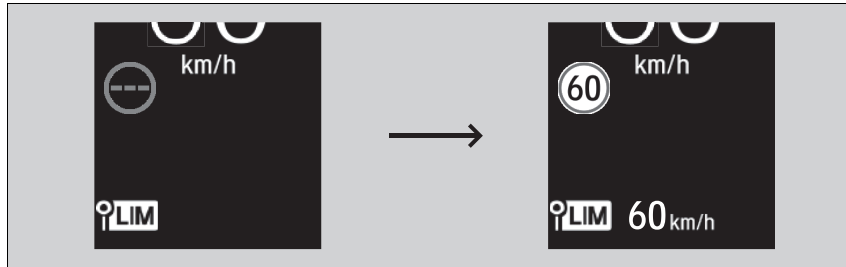

■ **When the traffic sign recognition system does not detect the speed limit sign for a time while the intelligent speed limiter is activated**

While driving, in addition to when the traffic sign recognition system detects no speed limit sign, the traffic sign recognition system may display no speed limit. But, intelligent speed limiter functions continue.

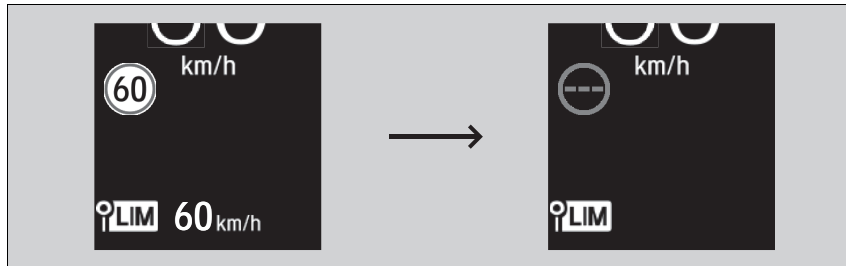

■ To Adjust the Speed Limit

Increase or decrease the speed limit by using the **RES/+** or **SET/-** button on the steering wheel.

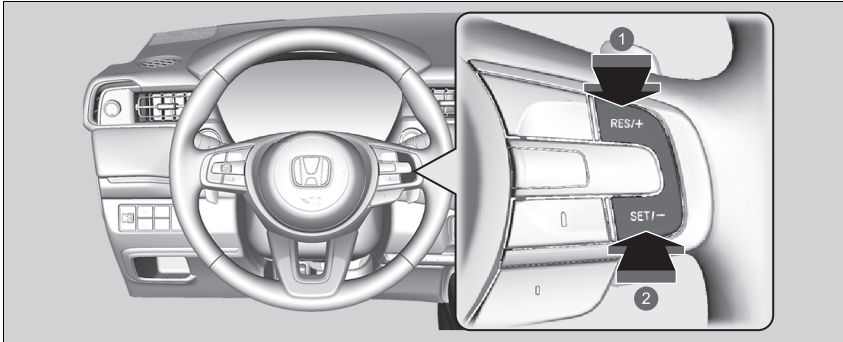

- ❶ To increase speed
- ❷ To decrease speed

- Each time you press the button, the speed limit is increased or decreased by about 1 km/h or 1 mph accordingly.
- You can increase the speed limit until +10 km/h or +5 mph on the basis of the speed limit that the traffic sign recognition system detects.
- You can decrease the speed limit until -10 km/h or -5 mph on the basis of the speed limit that the traffic sign recognition system detects.
- You can accelerate until the set speed is reached. If your vehicle speed is higher than the speed limit that the traffic sign recognition system detects, your vehicle decelerates slowly to the speed limit.

Continued

☒ To Adjust the Speed Limit

A negative or positive offset with respect to the speed limit will be reset automatically when the traffic sign recognition system detects the new speed limit sign.

You cannot decrease the speed limit less than 30 km/h (18 mph).

■ Exceeding the Speed Limit Temporarily

The speed limit can be exceeded by depressing the accelerator pedal fully.

- ▶ The displayed speed limit blinks.
The beeper sounds once the speed limit has been exceeded.

■ To Cancel

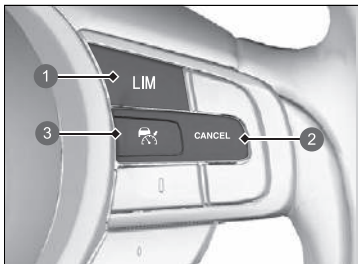

- ① LIM Button
- ② CANCEL Button
- ③  Button

To cancel the intelligent speed limiter, do any of the following:

- Press the **CANCEL** button.
- Press the  button.
- Press the **LIM** button.

⌘ Exceeding the Speed Limit Temporarily

The beeper sounds when the vehicle speed goes higher than the set speed limit with the acceleration pedal depressed completely.

The intelligent speed limiter resumes working once the vehicle speed goes lower than the set speed limit.

⌘ To Cancel

The intelligent speed limiter changes into adaptive cruise control (ACC) with Low Speed Follow or adjustable speed limiter if the **LIM** button is pressed.

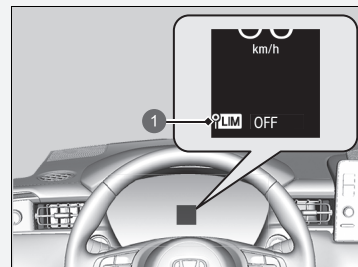

- ① Intelligent Speed Limiter Indicator (White)

If there is a problem with the system or traffic sign recognition system when you are using the intelligent speed limiter, the beeper sounds and **OFF** comes on. The intelligent speed limiter will be turned off.

⌘ **Traffic Sign Recognition System** P. 461

Vehicle Stability Assist (VSA) System

VSA helps to stabilise the vehicle during cornering if the vehicle turns more or less than what was intended. It also assists in maintaining traction on slippery surfaces. It does so by regulating engine and motor output and selectively applying the brakes.

VSA Operation

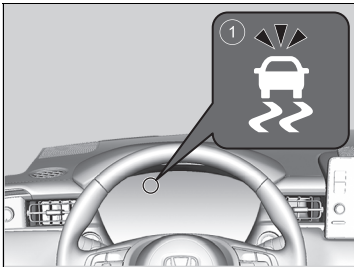

1 VSA System Indicator

When VSA activates, you may notice that the engine and motor do not respond to the accelerator. You may also notice some noise from the hydraulic brake system. You will also see the indicator blink.

Vehicle Stability Assist (VSA) System

The VSA may not function properly if tyre type and size are mixed. Make sure to use the same size and type of tyre, and the air pressures as specified.

When the VSA system indicator comes on and stays on while driving, there may be a problem with the system. While this may not interfere with normal driving, have your vehicle checked by a dealer immediately.

VSA cannot enhance stability in all driving situations and does not control the entire braking system. You still need to drive and corner at speeds appropriate for the conditions and always leave a sufficient margin of safety.

The main function of the VSA system is generally known as Electronic Stability Control (ESC). The system also includes a traction control function.

The indicators for the adaptive cruise control (ACC) with low speed follow (amber), vehicle stability assist (VSA) system, vehicle stability assist (VSA) OFF, low tyre pressure/deflation warning system, and safety support (amber) may come on after reconnecting the battery.

Drive a short distance at more than 20 km/h (12 mph). The indicator should go off. If it does not, have your vehicle checked by a dealer.

■ VSA On and Off

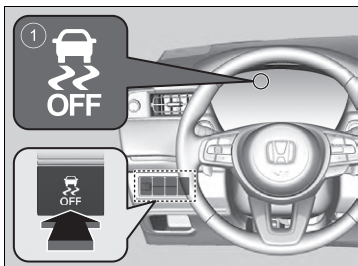

1 VSA OFF Indicator

This button is on the driver side control panel. To partially disable VSA functionality/features, press and hold it until you hear a beep.

Your vehicle will have normal braking and cornering ability, but traction control function will be less effective.

To restore VSA functionality/features, press the  button until you hear a beep.

VSA is turned on every time you turn the power system on, even if you turned it off the last time you drove the vehicle.

▶▶ Vehicle Stability Assist (VSA) System

In certain unusual conditions when your vehicle gets stuck in shallow mud or fresh snow, it may be easier to free it with the VSA temporarily switched off.

When the  button is pressed, the traction control function becomes less effective. This allows for the wheels to spin more freely at low speed. You should only attempt to free your vehicle with the VSA off if you are not able to free it when the VSA is on.

Immediately after freeing your vehicle, be sure to switch VSA on again. We do not recommend driving your vehicle with the VSA system switched off.

You may hear a motor sound coming from the engine compartment while system checks are being performed immediately after turning the power system on or while driving. This is normal.

Agile Handling Assist

Lightly brakes the front wheels, as needed, when you turn the steering wheel, and helps to support the vehicle's stability and performance during cornering.

ⓘ Agile Handling Assist

The agile handling assist cannot enhance stability in all driving situations. You still need to drive and corner at speeds appropriate for the conditions and always leave a sufficient margin of safety.

When the VSA system indicator comes on and stays on while driving, the agile handling assist does not activate.

You may hear a sound coming from the engine compartment while the agile handling assist is activated. This is normal.

Deflation Warning System

Instead of directly measuring the pressure in each tyre, the deflation warning system on this vehicle monitors and compares the rolling radius and rotational characteristics of each wheel and tyre while you are driving to determine if one or more tyres are significantly under-inflated.

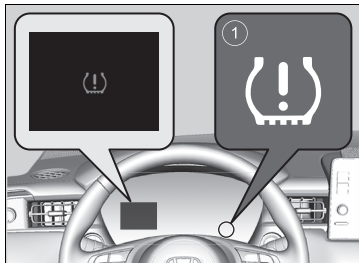

① Low Tyre Pressure/Deflation Warning System Indicator

This will cause the low tyre pressure/deflation warning system indicator to come on and a message to appear on the gauge.

■ Deflation Warning System Calibration

You must start deflation warning system calibration every time you:

- Adjust the pressure in one or more tyres.
- Rotate the tyres.
- Replace one or more tyres.

Before calibrating the deflation warning system:

- Set the cold tyre pressure in all four tyres.
➤ **Checking Tyres** P. 541

Make sure:

- The vehicle is at a complete stop.
- The transmission is in **P**.
- The power mode is in ON.

➤ Deflation Warning System

The system does not monitor the tyres when driving at low speed.

Conditions such as low ambient temperature and altitude change directly affect tyre pressure and can trigger the low tyre pressure/deflation warning system indicator to come on.

Tyre pressure checked and inflated in:

- Warm weather can become under-inflated in colder weather.
- Cold weather can become overinflated in warmer weather.

The low tyre pressure/deflation warning system indicator will not come on as a result of overinflation.

The deflation warning system may not function properly if tyre type and size are mixed.

Make sure to use the same size and type of tyre.

➤ **Checking and Maintaining Tyres** P. 541

The indicators for the adaptive cruise control (ACC) with low speed follow (amber), vehicle stability assist (VSA) system, vehicle stability assist (VSA) OFF, low tyre pressure/deflation warning system, and safety support (amber) may come on along with a message in the gauge after reconnecting the battery. Drive a short distance at more than 20 km/h (12 mph). The indicator should go off. If it does not, have your vehicle checked by a dealer.



You can calibrate the system from the customized feature on the audio/information screen.

1. Set the power mode to ON.
2. Press the  button.
3. Select **Vehicle Settings**.
4. Select **Deflation Warning System**.

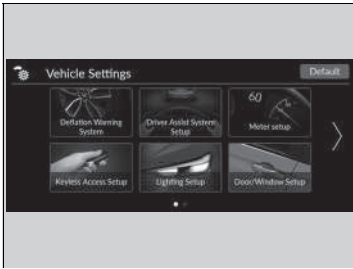

5. Select **Calibrate** or **Cancel**.
 - If the **Calibration Failed to Start** message appears, repeat step 5.
 - The calibration process finishes automatically.

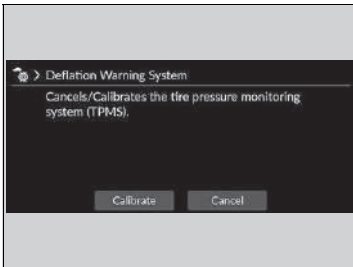

⌘ Deflation Warning System

The low tyre pressure/deflation warning system indicator may come on with a delay or may not come on at all when:

- You rapidly accelerate, decelerate, or turn the steering wheel.
- You drive on snowy or slippery roads.
- Tyre chains are used.

The low tyre pressure/deflation warning system indicator may come on under the following conditions:

- There is a heavier and uneven load on the tyres than the condition at initialisation.
- Tyre chains are used.

⌘ Deflation Warning System Calibration

The calibration process requires approximately 30 minutes of cumulative driving at speeds between 40-100 km/h (25-62 mph).

During this period, if the power mode is set to on and the vehicle is not moved within 45 seconds, you may notice the low tyre pressure indicator comes on briefly. This is normal and indicates that the calibration process is not yet complete.

If the tyre chains are installed, remove them before calibrating the deflation warning system.

If the low tyre pressure/deflation warning system indicator comes on even when the properly inflated specified regular tyres are installed, have your vehicle checked by a dealer.

We recommend that the tyres be replaced with the same brand, model, and size as the originals. Ask a dealer for details.

Blind spot information System*

When the system detects vehicles approaching from behind in adjacent lanes, the appropriate indicator comes on, providing assistance when you change lanes.

▶▶ Blind spot information System*

Important Safety Reminder

Like all assistance systems, the Blind Spot Information System has limitations. Always look in your mirrors, to either side of your vehicle, and behind you for other vehicles before changing lanes. Overreliance on the Blind Spot Information System may result in a collision.

Have your vehicle checked by a dealer in the following situations:

- The rear bumper or area around the radar sensors is strongly impacted.
- The indicator does not come on even if a vehicle in the alert zone should have been detected.
- The rear bumper or any system components need to be repaired.

If the rear bumper or any system components are repaired, the system will revert to alert zone 1 until it is able to adapt and expand to alert zone 1 and 2.

■ How the System Works

The system activates when your vehicle is moving forward at about 32km/h (20mph) or above.

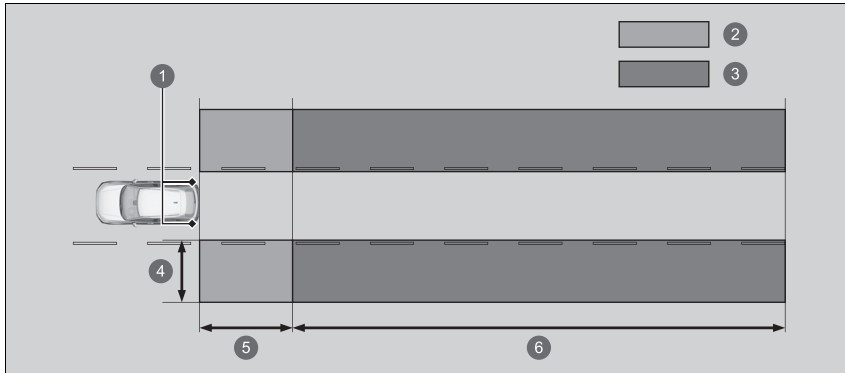

- ❶ Radar Sensors: underneath the rear bumper corners
 - ❷ Alert Zone 1
 - ❸ Alert Zone 2
- Alert zone range
- ❹ Approx. 0.5 ~ 3 m (1.6 ~ 10 ft.) from vehicle side.
 - ❺ Approx. 3 m (10 ft.) from rear bumper.
 - ❻ Approx. 3 ~ 25 m (10 ~ 82 ft.) behind from rear bumper. (The faster the approaching vehicle, the further away it will be detected.)

The initially set alert zone is alert zone 1. Over time, after the vehicle has been driven on straight roads with traffic and roadside objects, the system will adapt and expand the alert zone (alert zone 1 and 2).

Continued

■ When the system detects a vehicle

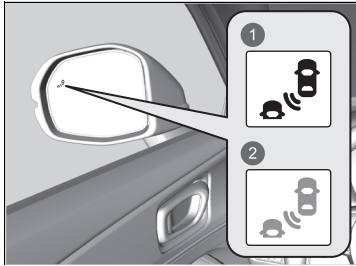

- 1 Comes On
- 2 Blinks

Blind spot information System Alert Indicator:
Located on the outside rearview mirror on
both sides.

Comes on when:

- A vehicle approaches you from behind to overtake you at a speed difference of no more than about 50 km/h (31 mph).
- You pass a vehicle at a speed difference of no more than about 20 km/h (12 mph).

Blinks and a beeper sounds when:

You use the turn signal lever to signal a turn in the direction of the detected vehicle while the Blind spot information indicator is on.

- ▶ The beeper sounds three times.

▣ Blind spot information System*

For proper Blind Spot Information System operation:

- Always keep the rear bumper and area around the radar sensors clean.
- Do not cover the rear bumper corner area with labels or stickers of any kind.

The system is for your convenience only. Even if an object is within the alert zone, the following situations may occur:

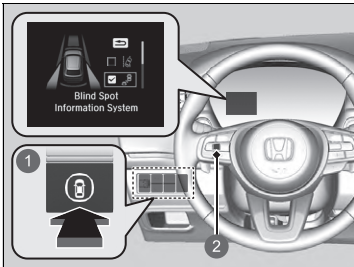

- The Blind Spot Information System alert indicator does not come and the  **Blind Spot Information Not Available** appears on the driver information interface.
- The Blind Spot Information System alert indicator may come on even with the message displayed.

Blind spot information System On and Off



- 1 Safety Support Switch
- 2 Left Selector Wheel

When you turn the blind spot information system on and off, do the following.

1. Press the safety support switch.
2. Roll the left selector wheel to the  symbol and push it.
 - ▶ A message appears on the driver information interface when the system turns on or off.
 - ▶ A check mark appears in the box and the colour of the  symbol changes to green when the system is on. The check mark disappear and the colour of the  symbol changes to grey when the system is off.

The Blind Spot Information System will stay on in the previously selected on (checked) or off (unchecked) setting each time you start the engine.

Blind spot information System*

You can also select the safety support content from the driver information interface.

▶ **Driver Information Interface** P. 135

You can change the setting for the blind spot information system.

▶ **Customized Features** P. 304

* Not available on all models

■ Blind Spot Information System Conditions and Limitations

The Blind Spot Information System alert indicator may not come on under the following conditions:

- There is a large speed difference between your vehicle and the vehicle in the adjacent lane.
- A vehicle is parked in a side lane.
- An object not detected by the radar sensors approaches or passes your vehicle.
- The vehicle driving in the adjacent lane is a motorcycle or other small vehicle.

The Blind Spot Information System may not operate correctly under the following conditions:

- Making a turn at an intersection.
- Objects (guard rails, poles, trees, etc.) are detected.
- An object that does not reflect radio waves well or a motorcycle is in the alert zone.
- Driving on a curved road.
- A vehicle is moving from a far lane to the adjacent lane.
- The system picks up signal interference such as other radar sensors from another vehicle or strong radio wave transmitted from a facility nearby.
- The rear bumper or the area around the radar sensors is covered by dirt, mud, snow, ice, etc.
- The rear bumper or the area around the radar sensors has been damaged or deformed.
- In bad weather (heavy rain, snow, and fog).
- Making a short turn or driving on a bumpy road that slightly tilts the vehicle.

High Voltage Battery

The High Voltage battery gradually discharges even if the vehicle is not in use. As a result, if your vehicle is parked for an extended period of time, the battery charge level will become low. Extended periods of time at a low state of charge will shorten battery life. To maintain the battery state of charge, drive your vehicle for more than 30 minutes at least once every three months.

Extreme high temperatures can affect the battery life. You can minimise the effects by parking the vehicle in the shade during the summer.

⚠ High Voltage Battery

Be careful not to let the High Voltage battery drain too much. If the battery level becomes close to zero, it will make it impossible to start the power system.

Adjusting Headlight Distribution

Driving the right-hand type vehicle in right-hand traffic, or the left-hand type vehicle in left-hand traffic causes headlight glare to oncoming vehicles. You need to alter the headlight beam distribution using masking tape.

Left-hand drive models

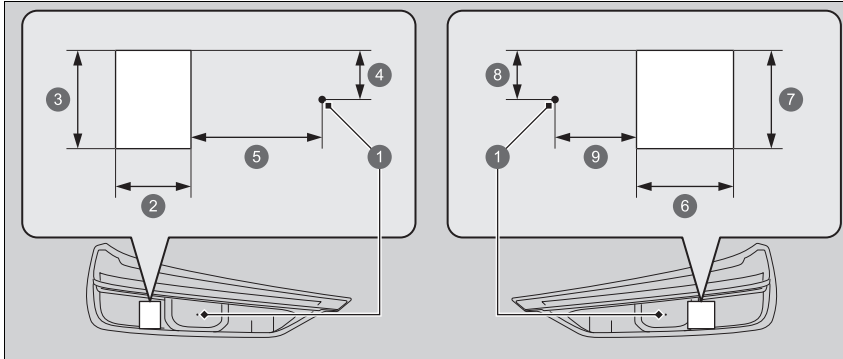

- 1 Centre Point
- 2 43 mm
- 3 45 mm
- 4 23 mm
- 5 74 mm
- 6 53 mm
- 7 45 mm
- 8 23 mm
- 9 44 mm

Adjusting Headlight Distribution

Be careful not to adhere the tape to an incorrect location. If the headlight beam is distributed incorrectly, it may not comply with your country's legal requirements. Ask your dealer for details.

Right-hand drive models

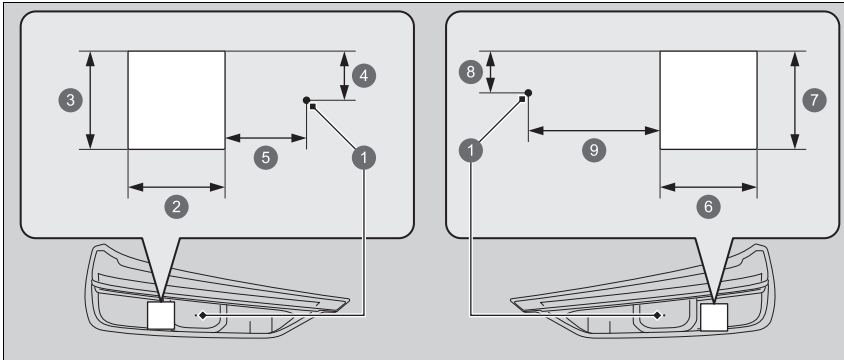

- ① Centre Point
- ② 53 mm
- ③ 45 mm
- ④ 23 mm
- ⑤ 42 mm
- ⑥ 44 mm
- ⑦ 45 mm
- ⑧ 23 mm
- ⑨ 72 mm

1. Prepare for two pieces of masking tape as shown.
 - ▶ Use masking tape that can shut out light, such as seal type waterproof vinyl.
2. Affix the tape to the lens as shown.

Honda Sensing is a driver support system which employs the use of two distinctly different kinds of sensors, a front wide view camera mounted to the interior side of the windscreen, behind the rearview mirror, and the sonar sensors located in the front and rear bumpers.

Honda Sensing has following functions.

■ The functions which do not require switch operations to activate

- Collision Mitigation Braking System (CMBS) 📖 P. 405
- Low Speed Braking Control 📖 P. 417
- Road Departure Mitigation System 📖 P. 453
- Traffic Sign Recognition System 📖 P. 461

■ The functions which require switch operations to activate

- Adaptive Cruise Control (ACC) with Low Speed Follow 📖 P. 423
- Lane Keeping Assist System (LKAS) 📖 P. 441

Operation Switches for the Adaptive Cruise Control (ACC) with Low Speed Follow/Lane Keeping Assist System (LKAS)

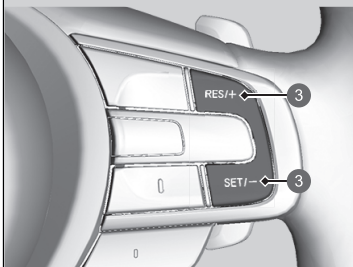
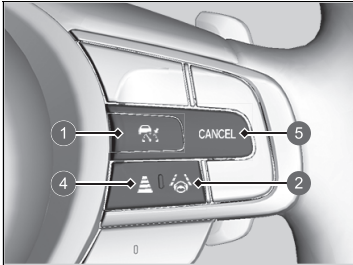

- 1**  **Button**
Press to activate standby mode for ACC with Low Speed Follow. Or press to cancel the system.
- 2** **LKAS Button**
Press to activate standby mode for LKAS. Or press to cancel the system.
- 3** **RES/+ and SET/- Buttons**
Press to set or resume the ACC with Low Speed Follow or to adjust the vehicle speed.
- 4** **Interval Button**
Press to change the ACC with Low Speed Follow following-interval.
- 5** **CANCEL Button**
Press to cancel ACC with Low Speed Follow.

■ Gauge Content

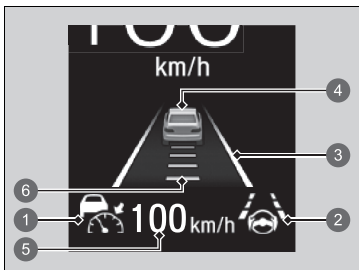

You can see the current state of Adaptive Cruise Control (ACC) with Low Speed Follow and Lane Keeping Assist System (LKAS).

- ① Indicates that ACC with Low Speed Follow is ready to be activated.
 - White: The system is standby.
 - Green: The system is on.
 - Amber: There is a problem with the system.
- ② Indicates that LKAS is ready to be activated.
 - White: The system is standby.
 - Green: The system is on.
 - Amber: There is a problem with the system.
- ③ Indicates that LKAS is activated and whether or not traffic lane lines are detected.
 - White Lines: Traffic lane lines are detected.
 - Green Lines: The system is on.
 - Amber Lines: Lane departure is detected.
- ④ Indicates whether or not ACC with Low Speed Follow detected the vehicle ahead.
- ⑤ Indicates that ACC with Low Speed Follow shows the set vehicle speed.
 - White: Set Vehicle Speed
 - Gray: Prior Set Speed
- ⑥ Indicates that ACC with Low Speed Follow shows the set vehicle interval.

Collision Mitigation Braking System (CMBS)

The system can assist you when it determines there is a possibility of your vehicle colliding with a vehicle (including motorcycles) ahead from behind, an oncoming vehicle in front, a pedestrian, or someone riding a bicycle (moving bicycle). The CMBS is designed to alert you when the potential for a collision is determined, as well as assist in reducing speed, avoiding collisions, and reducing collision severity.

Collision Mitigation Braking System (CMBS)

Important Safety Reminder

The CMBS is designed to reduce the severity of an unavoidable collision. It does not prevent collision nor stop the vehicle automatically. It is still your responsibility to operate the brake pedal and steering wheel appropriately according to the driving conditions.

The CMBS may not activate or may not detect a vehicle in front of your vehicle under certain conditions:

➤ **CMBS Conditions and Limitations** P. 410

You can read about handling information for the front wide view camera equipped with this system.

➤ **Front Wide View Camera** P. 468

When the CMBS is activated, it will continue to operate even if the accelerator pedal is partially depressed. However, it will be cancelled if the accelerator pedal is fully depressed.

■ How the system works

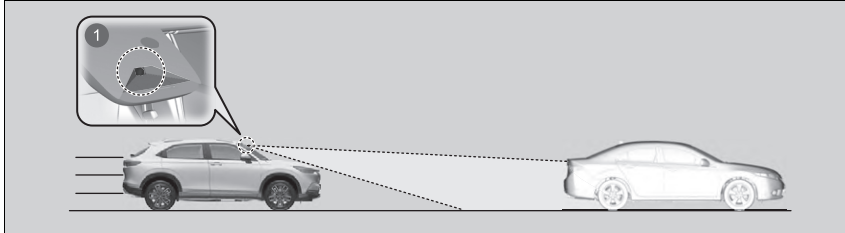

① The front wide view camera is located behind the rearview mirror.

The system starts monitoring the roadway ahead when your vehicle speed is about 5 km/h (3 mph) or above and will search for a vehicle, pedestrian, or moving bicycle in front of you.

The CMBS activates when:

- The speed difference between your vehicle and a vehicle, pedestrian, or moving bicycle detected in front of you becomes about 5 km/h (3 mph) and over with a chance of a collision.
- Your vehicle drives at about 30 km/h (18 mph) or less and there is a chance of in frontal collision with oncoming a detected vehicle when you turn left*1/right*2 at an intersection.
- Your vehicle speed is about 100 km/h (62 mph) or less and the system determines there is a chance of a collision with:
 - An oncoming or stationary vehicle detected in front of you.
 - A pedestrian or moving bicycle detected in front of you.

*1: Left-hand Drive Type

*2: Right-hand Drive Type

▶ How the system works

The front wide view camera in the CMBS is also designed to detect pedestrians. However, this pedestrian detection feature may not activate or may not detect a pedestrian in front of your vehicle under certain conditions. Refer to the ones indicating the pedestrian detection limitations from the list.

▶ **CMBS Conditions and Limitations** P. 410

The CMBS will be cancelled when your vehicle stops or the system determines there no longer is the potential for a collision.

The CMBS may also be cancelled when a driver operates the steering wheel and the brake or accelerator pedal to avoid a collision.

■ When the system activates

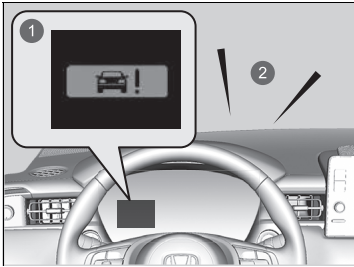

The system provides visual and audible alerts of a possible collision, and stops if the collision is avoided.

- ▶ Take appropriate action to prevent a collision (apply the brakes, change lanes, etc.)

- ① Visual Alerts
- ② Audible Alert

You can change the distance (**Far/Normal/Near**) between vehicles at which the system's earliest collision alert will come on through the audio/information screen setting options.

➤ **Customized Features** P. 304

■ Collision Alert Stages

The system has three alert stages for a possible collision. However, depending on circumstances, the CMBS may not go through all of the stages before initiating the last stage.

Distance between vehicles	CMBS		
	The sensors detect a vehicle	Audible & Visual WARNINGS	Braking
Stage one 	There is a risk of a collision with the vehicle ahead of you.	When in Far , visual and audible alerts come on at a longer distance from a vehicle ahead than in Normal setting, and in Near , at a shorter distance than in Normal .	—
Stage two 	The risk of a collision has increased, time to respond is reduced.	Visual and audible alerts.	Lightly applied
Stage three 	The CMBS determines that a collision is unavoidable.		Forcefully applied

- ① Your Vehicle
- ② Vehicle Ahead
- ③ Far
- ④ Normal
- ⑤ Near

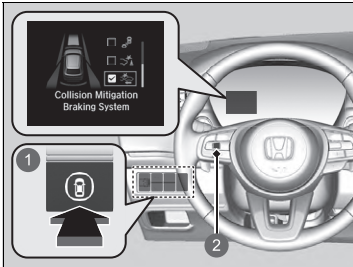

Driving

CMBS On and Off



- ❶ Safety Support Switch
- ❷ Left Selector Wheel

When you turn the CMBS on and off, do the following.

1. Press the safety support switch.
2. Roll the left selector wheel to the  symbol and push it.
 - ▶ A message appears on the driver information interface when the system turns on or off.
 - ▶ A check mark appears in the box and the colour of the  symbol changes to green when the system is on. The check mark disappears and the colour of the  symbol changes to gray when the system is off.

The CMBS is turned on every time you turn the power system on, even if you turned it off the last time you drove the vehicle.

Collision Mitigation Braking System (CMBS)

You cannot turn the CMBS off while driving.

The CMBS may automatically shut off, and the safety support indicator (amber) will come and stay on under certain conditions.

▶ **CMBS Conditions and Limitations** P. 410

The CMBS is not activated for about 15 seconds after the power system is turned on.

You can also select the safety support content from the driver information interface.

▶ **Driver Information Interface** P. 135

The adaptive cruise control (ACC) with low speed follow (amber), vehicle stability assist (VSA) system, vehicle stability assist (VSA) OFF, low tyre pressure/deflation warning system, and safety support (amber) indicators may come on in amber along with a message in the gauge when you set the power mode to ON after reconnecting the 12-volt battery. Drive a short distance at more than 20 km/h (12 mph). Each indicator should go off. If any do not, have your vehicle checked by a dealer.

Have your vehicle checked by a dealer if you find any unusual behaviour of the system (e.g. the warning message appears too frequently).

■ CMBS Conditions and Limitations

The system may automatically shut off and the safety support indicator (amber) will come on under certain conditions. Some examples of these conditions are listed below. Other conditions may reduce some of the CMBS functions.

➤ **Front Wide View Camera** P. 468

■ Environmental conditions

- Driving in bad weather (rain, fog, snow, etc.).
- Sudden changes between light and dark, such as the entrance or exit of a tunnel or the shadows of trees, buildings, etc.
- Driving into low sunlight (e.g., at dawn or dusk).
- Strong light is reflected onto vehicles, pedestrians, moving bicycles, or road surfaces.
- Water is sprayed by or snow blown from a vehicle ahead.
- Driving at night or in a dark place such as a tunnel (due to low-light conditions, vehicles, pedestrians, or moving bicycles may not be illuminated).

■ Roadway conditions

- Driving on curvy, winding, undulating, or sloping roads.
- There is a film of water or puddles on the road surface.
- Driving on rutted roads (snowy or unpaved roads, etc.).
- Your vehicle is strongly shaken on uneven road surfaces.

■ Vehicle conditions

- The vehicle is tilted due to heavy luggage in the luggage area or rear seats.
- Tyre chains are installed.
- Driving at night or in a dark place (e.g., a tunnel) with the headlights off.
- The front of the front wide view camera is covered by dirt, fog, rain, mud, wet snow, seals, accessories, stickers, or film on the windscreen.
- There is residue on the windscreen from the windscreen wipers.
- When lighting is weak due to dirt covering the headlight lenses, or there is poor visibility in a dark place due to the headlights being improperly adjusted.
- Abnormal tyre or wheel condition (incorrect sizes, varied sizes or construction, improperly inflated, etc.).
- The suspension has been modified.

■ **Examples of limitations on the correct detection of the front wide view camera due to the condition of the vehicle ahead of you, oncoming vehicles, pedestrians, or moving bicycles**

- The distance between your vehicle and the vehicle ahead of you, oncoming vehicle, pedestrian, or moving bicycle ahead of you is too short.
- The vehicle ahead of you, oncoming vehicle, pedestrian, or moving bicycle suddenly cuts in front of or jumps out in front of you.
- The bicycle is stopped.
- The oncoming vehicle or vehicle ahead of you is sideways.
- When the vehicle ahead of you, oncoming vehicle, pedestrian, or moving bicycle blends in with the background, preventing the system from recognising them.
- When several pedestrians or bicycles are moving ahead of you in a group.
- When a pedestrian or moving bicycle crosses the road too quickly.
- A pedestrian or moving bicycle approaches from the opposite direction.
- The headlights of the vehicle ahead of you or oncoming vehicle are lit on one side or not lit on either side in a dark place.
- When part of a pedestrian (heads, limbs, etc.) is hidden by luggage.
- When a pedestrian is bent over or squatting, when their hands are raised, or they are running.
- When the pedestrian is shorter than about 1 metre (3.3 feet) or taller than about 2 metres (6.6 feet) in height.
- When the pedestrian is pushing a stroller or bicycle.

🔗 Collision Mitigation Braking System (CMBS)

Make sure that all the tyres are of the same specified size, type and brand, and that they are evenly worn. If you use tyres of different sizes, types, brands, or degree of wear, the system may not work properly.

Do not modify the suspension. Altering the height of the vehicle may prevent the system from working properly.

■ Examples of other limitations on detection or system operation

- When the vehicle ahead of you is a small motorcycle, motorcycle with a sidecar, wheelchair, or other specially shaped vehicle.
- When a vehicle is lower in the rear than the front such as lorries that are not carrying a load, or a narrow vehicle.
- When the vehicle ahead of you, oncoming vehicle, pedestrian or moving bicycle is not in front of the vehicle.
- The speed difference between your vehicle and the vehicle ahead of you, oncoming vehicle, pedestrian or moving bicycle is significantly large.
- When the vehicle or moving bicycle in front of you slows suddenly.
- When the driver operates the brake pedal and steering wheel to avoid a collision.
- When you approach the vehicle ahead of you, oncoming vehicle, pedestrians or moving bicycles while accelerating rapidly or operating the steering wheel (except when turning left*¹/right*² at an intersection etc.)*³.
- When the moving bicycle is a child-sized bicycle, folding bicycle, three-wheeler or other bicycle with small tyres, or a long bicycle like a tandem bicycle.
- When the front wide view camera cannot correctly identify the shape of the vehicle ahead of you, oncoming vehicle, pedestrian, or moving bicycle.
- When the minimum ground clearance of a vehicle ahead of you is extremely high.

*1: Left-hand Drive Type

*2: Right-hand Drive Type

*3: When there is a possibility of a frontal collision with the oncoming vehicle while turning left*¹/right*², the CMBS is activated. However, it may not be activated if you suddenly turn the steering wheel.

Continued

■ Automatic shutoff

The CMBS may automatically shut itself off and the safety support indicator (amber) comes and stays on when:

- You drive off-road or on a mountain road, or curved and winding road for an extended period.
- Driving in bad weather (rain, fog, snow, etc.).
- Driving with the parking brake applied.
- The front wide view camera temperature gets too high.
- The front of the front wide view camera is covered by dirt, fog, rain, mud, wet snow, seals, accessories, stickers, or film on the windscreen.
- An abnormal tyre condition is detected (incorrect tyre size, flat tyre, etc.).

Once the conditions that caused the CMBS to shut off improve or are addressed (e.g., cleaning), the system comes back on.

■ With Little Chance of a Collision

Even if there is little chance of a collision, the CMBS may activate under the following conditions:

- Your vehicle approaches or passes another vehicle that is making a left or right turn.
- Your vehicle approaches another vehicle ahead of you and you change lanes to pass.
- Your vehicle approaches another vehicle at an intersection, etc.

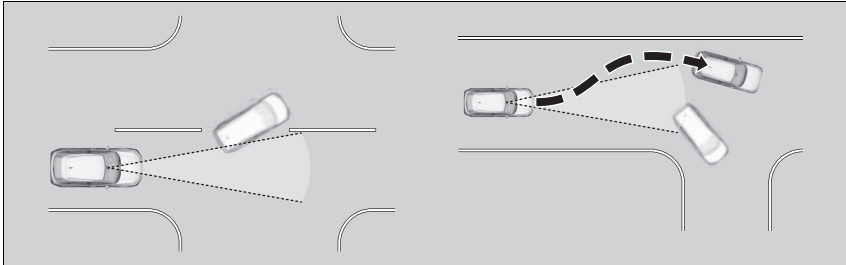

- When passing through a low or narrow gate at a speed well over the speed limit.
- When there are traffic signs or structures such as guard rails are beside the road along a curve.

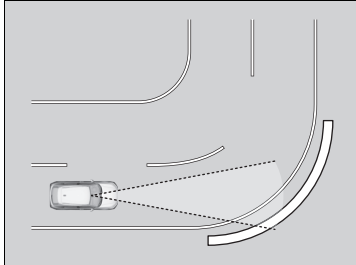

- When driving through curves, your vehicle comes to a point where the oncoming vehicle is right in front of you.

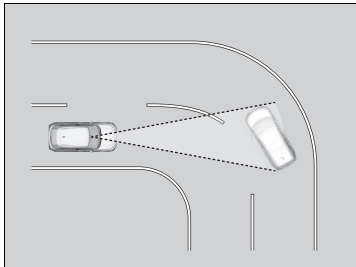

- When approaching stationary vehicles or walls, such as when parking.

Low Speed Braking Control

Using sonar sensors located on the front and rear bumpers, this system detects if there is danger of a potential collision with a wall or other obstacle during normal driving or when the accelerator pedal is depressed with too much force. The system then assists in avoiding collisions and reducing damage from impact through Low Speed Brake function and/or assistive driving power suppression.

Low Speed Braking Control

⚠ WARNING

It is not possible for the Low Speed Braking Control system to avoid collisions or reduce damage from collisions in all situations where the accelerator has been depressed accidentally or with too much force. Overreliance on this system may result in a collision and serious injury or death. It is your responsibility to always check your shift position, pedal location and surroundings, and safely operate the vehicle.

If the Low Speed Braking Control activates in a situation where you do not want automatic brake application (such as when the vehicle is between two railroad crossing gates), simply press the brake pedal to deactivate the system and then continue to drive as intended.

If the system is activated by curbs/parking curbs or level differences on the road and you are unable to park or clear them, turn the system off.

Continued

■ How the System Works

■ Low Speed Brake function

The Low Speed Brake function provides a visual and audible alert when the vehicle is moving between approximately 2 and 10 km/h (1 and 6 mph) and there is the possibility of a collision with a detected wall or other obstacles, as well as providing assistance with braking.

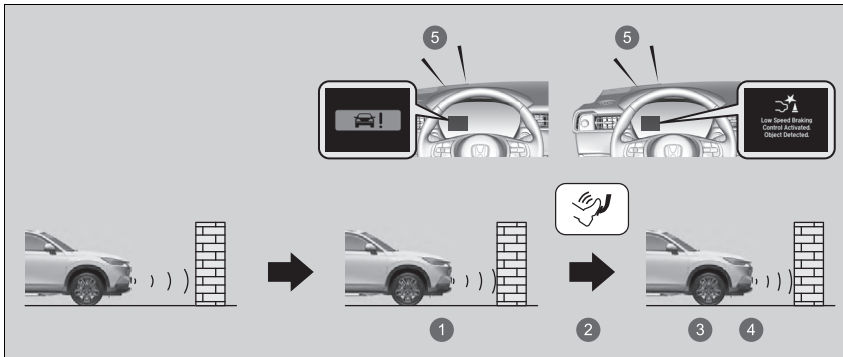

- ① The vehicle applies brake
- ② Driver depresses brake pedal
- ③ Stop
- ④ Remove brake after maintaining stationary position
- ⑤ Beep

If the only rear sensors are turned off using the parking sensor system, the Low Speed Brake function is not working when reversing.

➡ **Turning off All Rear Sensors** P. 487

▶▶ Low Speed Braking Control

For directions on the proper handling of the sonar sensors, please refer to the following page.

➡ **Sonar Sensors** P. 470

The vehicle will release the brake and start moving a few seconds after the system is activated. To keep the vehicle stopped, keep the brake pedal depressed or put the transmission into **P**.

In order to prevent the system from activating when not needed, always turn it off during vehicle maintenance, when loading on ships, trucks, and so on, or when using a chassis dynamometer, free rollers for inspection.

■ Collision Mitigation Throttle Control and Rear Collision Mitigation Throttle Control

Throttle Control

When the vehicle is stopped or moving at less than 10 km/h (6 mph) and there is an obstacle such as a wall detected near the front of or back of the vehicle, if the accelerator pedal is depressed more than necessary, the system will inform you with a visual and audible alert. At the same time, the system will prevent sudden forward or backwards movement by limiting the output of the power system, then Low Speed Brake will activate nearby the obstacle.

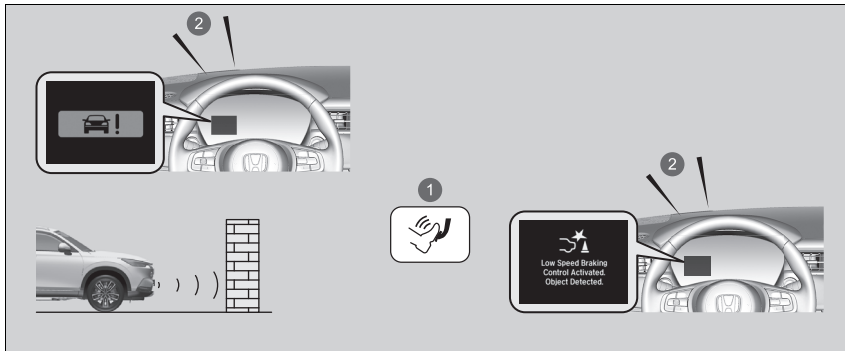

- ① Accidental depression of the accelerator/Limiting the output of the power system
- ② Beep

Collision Mitigation Throttle Control and Rear Collision Mitigation Throttle Control will not activate in the following situations.

When moving forward:

When on a steep slope or the shift position is in **P**, **R**, or **N**.

When reversing:

When on a steep slope or the shift position is in a position other than **R**.

Continued

If the only rear sensors are turned off using the parking sensor system, the assistive driving power suppression is not working when reversing.

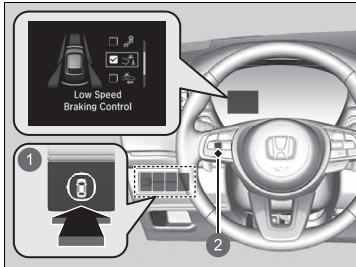

▶ **Turning off All Rear Sensors** P. 487

■ System On and Off



- 1 Safety Support Switch
- 2 Left Selector Wheel

When you turn the system on and off, do the following.

1. Press the safety support switch.
 - ▶ A message appears on the driver information interface when the system turns on or off.
2. Roll the left selector wheel to the symbol and push it.
 - ▶ A check mark appears in the box and the colour of the  symbol changes to green when the system is on. The check mark disappear and the colour of the  symbol changes to gray when the system is off.

The system is turned on every time you start the power system, even if you turned it off the last time you drove the vehicle.

▶▶ System On and Off

You can also select the safety support content from the driver information interface.

▶ **Driver Information Interface** P. 135

The Low Speed Braking Control system may temporarily turn off after reconnecting the 12-volt battery.

The system will automatically turn ON after the vehicle has been moving at over 20 km/h (12 mph) for some time.

If the system does not turn on, have your vehicle checked by a dealer.

■ Conditions for Cancellation

Conditions for Collision Mitigation Throttle Control, and Rear Collision Mitigation Throttle Control.

- When the accelerator is no longer depressed.
- When the accelerator is depressed for approximately four seconds.
- When the brake pedal is depressed.
- When the steering wheel is turned and a collision avoided.

Conditions for Low Speed Brake function cancellation.

- A certain amount of time has passed since activation.

■ Low Speed Braking Control System Conditions and Limitations

The system may not operate correctly in the following conditions:

■ Examples of obstacles the sonar sensor cannot detect

- Obstacles that do not reflect sound waves well, such as people, snow, cloth, sponges, etc.
- Thin obstacles such as fences, bicycles, sign posts, etc.
- Short or small obstacles.
- Obstacles immediately in front of the bumper.
- Moving objects or obstacles that suddenly enter the road.
- Obstacles that are not perpendicular to the ground.

☒ Conditions for Cancellation

After Low Speed Braking Control has activated once, it will not activate again for the same obstacle. They can be activated again after driving for a certain distance after last activation.

Low Speed Braking Control activates separately when moving forward and reversing. (For example, if it activates when moving forward, it can be activated again immediately if reversing.)

However, if Low Speed Brake has been activated, in order to activate Collision Mitigation Throttle Control again, it is necessary to drive for a certain distance to reset the system.

■ **Examples of situations where the sonar sensor cannot detect obstacles**

- The sonar sensor is dirty (covered by snow, water, mud, etc.).
- The vehicle is too hot or cold.
- The steering wheel is turned sharply when approaching the obstacle at an angle.

■ **Examples of other cases where the system may not work correctly**

- The vehicle is tilted due to heavy load or suspension modifications.
- An abnormal tire or wheel condition (incorrect sizes, varied sizes or construction, improperly inflated, etc.).
- Bad weather conditions such as heavy rain, fog, snow, sandstorms, etc.
- The ambient temperature/humidity is too high or low.
- When going down a very steep slope.
- When close to other vehicles with sonar sensors or other objects that emit ultrasonic waves.

■ **Situations where the system may activate even without risk of a collision**

- When passing through short or narrow gates.
- When driving on uneven surfaces, grassy areas, or places with steps.
- When a sloped pillar or wall is protruding from a high position.
- When there are obstacles next to the road.
- When driving toward flags, curtains, tree branches, railroad crossing bars, etc.
- When driving on flooded roads.

Adaptive Cruise Control (ACC) with Low Speed Follow

Helps to maintain a constant vehicle speed and a set following-interval behind a vehicle detected ahead of yours and, if the detected vehicle comes to a stop, can decelerate and stop your vehicle, without you having to keep your foot on the brake or the accelerator.

When ACC with Low Speed Follow slows your vehicle by applying the brakes, your vehicle's brake lights will illuminate.

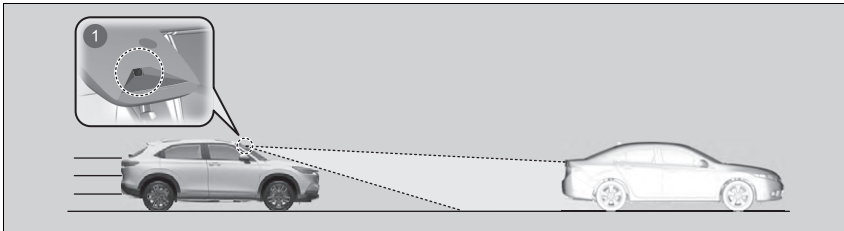

- ① The front wide view camera is located behind the rearview mirror.
- Vehicle speed for ACC with Low Speed Follow: **A vehicle is detected ahead within ACC with Low Speed Follow range** – ACC with Low Speed Follow operates at speeds up to 180 km/h (112 mph).
No vehicle is detected within ACC with Low Speed Follow range – ACC with Low Speed Follow operates at the speed of 30 km/h (18 mph) or above.
- Shift position for ACC with Low Speed Follow: In D.

Adaptive Cruise Control (ACC) with Low Speed Follow

⚠ WARNING

Improper use of ACC with Low Speed Follow can lead to a crash.

Use ACC with Low Speed Follow only when driving on motorways and in good road and weather conditions.

⚠ WARNING

ACC with Low Speed Follow has limited braking capability and may not stop your vehicle in time to avoid a collision with a vehicle that quickly stops in front of you.

Always be prepared to apply the brake pedal if the conditions require.

Important Reminder

As with any system, there are limits to ACC with Low Speed Follow. Use the brake pedal whenever necessary, and always keep a safe interval between your vehicle and other vehicles.

You can read about handling information for the front wide view camera equipped with this system.

▶ **Front Wide View Camera** P. 468

■ How to activate the system

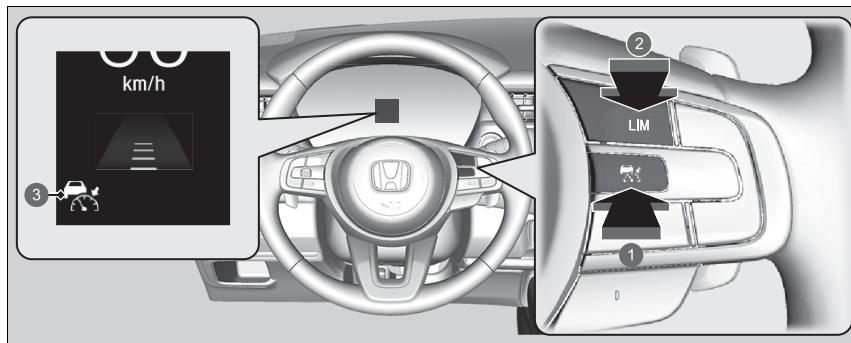

- 1 Button
Press the button on the steering wheel.
- 2 **LIM** Button
If a different indicator comes on, press the **LIM** button to change it to ACC with Low Speed Follow.
- 3 **The Indicator (White) is on in the gauge.**
ACC with Low Speed Follow is ready to use.

▶ Adaptive Cruise Control (ACC) with Low Speed Follow

ACC with Low Speed Follow may not work properly under certain conditions.

▶ **ACC with Low Speed Follow Conditions and Limitations** P. 431

Do not use ACC with Low Speed Follow under the following conditions:

- On roads with frequent lane change or continuous stop and go traffic, ACC with Low Speed Follow cannot keep an appropriate distance between your vehicle and the vehicle ahead of you.
- On roads with sharp turns.
- On roads with toll collection facilities or other objects between lanes of traffic, or in parking areas, or facilities with drive through access.
- On roads with bad weather (rain, fog, snow, etc.), ACC with Low Speed Follow may not detect the distance between your vehicle and the vehicle ahead of you properly.
- On roads with slippery or icy surfaces. The wheels may spin out and your vehicle may lose the control on the condition.
- On roads with steep uphill or steep downhill slopes.
- On roads with undulating slopes.

■ To Set the Vehicle Speed

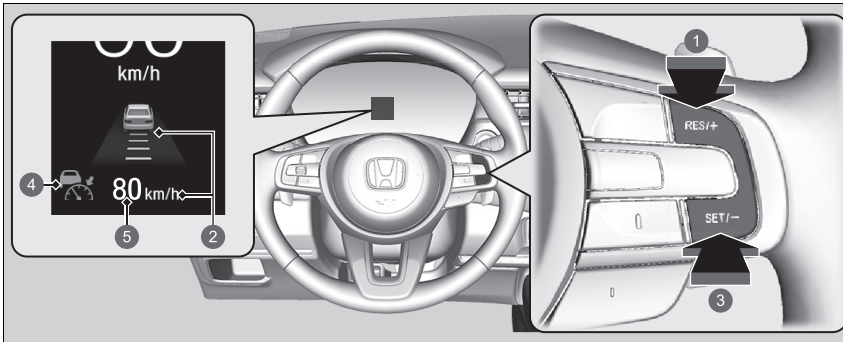

- ❶ **RES/+** Button
Press and release
- ❷ On when ACC with Low Speed Follow begins
- ❸ **SET/-** Button
Press and release
- ❹  Indicator (Green)
- ❺ Set Vehicle Speed (White)

▣ Adaptive Cruise Control (ACC) with Low Speed Follow

The indicators for the adaptive cruise control (ACC) with low speed follow (amber), vehicle stability assist (VSA) system, vehicle stability assist (VSA) OFF, low tyre pressure/deflation warning system, and safety support (amber) may come on after reconnecting the 12-volt battery.

Drive a short distance at more than 20 km/h (12 mph). The indicator should go off. If it does not, have your vehicle checked by a dealer.

▣ To Set the Vehicle Speed

You can switch the displayed set speed measurements on the audio/information screen between km/h and mph.

➤ **Customized Features** P. 304

When driving at about 30 km/h (18 mph) or above: Take your foot off the pedal and press the **RES/+** or **SET/-** buttons when you reach the desired speed. The moment you release the button, the set speed is fixed, and ACC with Low Speed Follow begins.

When driving slower than about 30 km/h (18 mph): If the vehicle is moving and the brake pedal is not depressed, pressing the button fixes the set speed to about 30 km/h (18 mph) regardless of current vehicle speed.

If your vehicle is stationary, you can set the vehicle speed even with the brake pedal depressed.

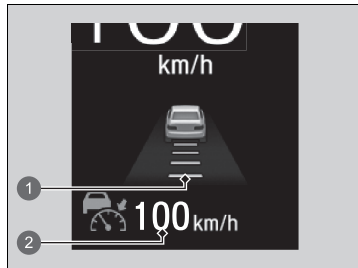

When ACC with Low Speed Follow starts operating, the vehicle icon, interval bars and set speed appear on the gauge.

- 1 Set Vehicle Interval
- 2 Set Vehicle Speed

■ When in Operation

■ There is a vehicle ahead

ACC with Low Speed Follow monitors if a vehicle ahead of you enters the ACC with Low Speed Follow range. If a vehicle is detected doing so, the ACC with Low Speed Follow system maintains or decelerates your vehicle's set speed in order to keep the vehicle's set following-interval from the vehicle ahead.

📌 **To Set or Change Following-interval** P. 436

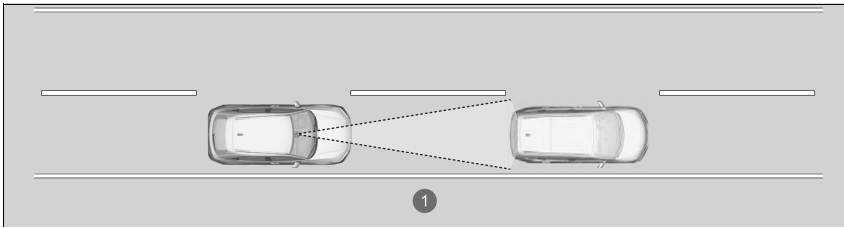

① ACC with Low Speed Follow Range: 120 m

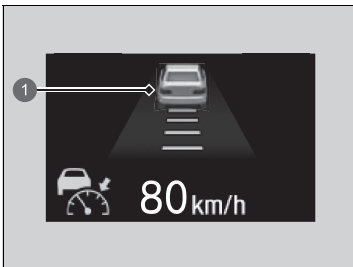

① A vehicle icon appears on the gauge.

When a vehicle whose speed is slower than your set speed comes in or cuts in front of you and is detected by the front wide view camera, your vehicle starts to slow down.

📌 When in Operation

If the vehicle ahead of you slows down abruptly, or if another vehicle cuts in front of you, the beeper sounds, a message appears on the driver information interface.

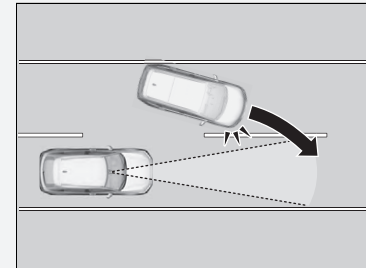

Depress the brake pedal, and keep an appropriate interval from the vehicle ahead.

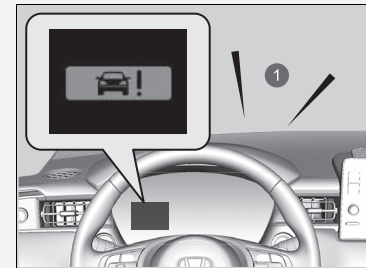

① Audible Alert

■ There is no vehicle ahead



- 1 A vehicle icon with line contour appears on the gauge.

Your vehicle maintains the set speed without having to keep your foot on the brake or accelerator pedal.

If there previously was a vehicle detected ahead that kept your vehicle from travelling at the set speed, ACC with Low Speed Follow accelerates your vehicle to the set speed, and then maintains it.

On steep downhill during ACC with Low Speed Follow, it brakes to inhibit excessive acceleration for maintaining the set speed. However the vehicle speed may become faster than the set speed.

■ When you depress the accelerator pedal

You can temporarily increase the vehicle speed. In this case, there is no audible or visual alert even if a vehicle is in the ACC with Low Speed Follow range.

ACC with Low Speed Follow stays on unless you cancel it. Once you release the accelerator pedal, the system resumes an appropriate speed for keeping the following-interval while a vehicle ahead is within the ACC with Low Speed Follow range.

⌘ When in Operation

Even if the interval between your vehicle and the vehicle detected ahead is short, ACC with Low Speed Follow may start accelerating your vehicle under the following circumstances:

- The vehicle ahead of you is going at almost the same speed as, or faster than, your vehicle.
- A vehicle that cuts in front of you is going faster than your vehicle, gradually increasing the interval between the vehicles.

You can also set the system to beep when a vehicle detected in front of you comes in and goes out of the ACC with Low Speed Follow detecting range. A vehicle detect beep on and off can be selected.

⌘ **Customized Features** P. 304

Limitations

You may need to use the brake to maintain a safe interval when using ACC with Low Speed Follow. Additionally, ACC with Low Speed Follow may not work properly under certain conditions.

⌘ **ACC with Low Speed Follow Conditions and Limitations** P. 431

⌘ When in Operation

- ACC with Low Speed Follow may temporarily control the interval between your vehicle and the vehicle in adjacent lane or surroundings of your vehicle depending on the road conditions (e.g. curves) or vehicle conditions (e.g. operating the steering wheel or the vehicle location in the lane).

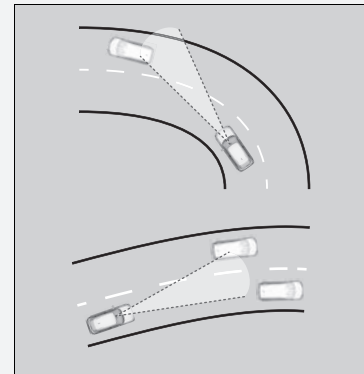

- When the vehicle ahead of you moves away, such as when entering an interchange or rest area, ACC with Low Speed Follow may continue to maintain the set following-interval for a short time.

■ A vehicle detected ahead is within ACC with Low Speed Follow range and slows to a stop

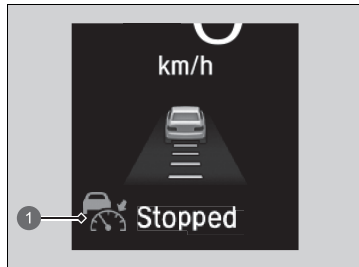

1  Indicator (Green)

Your vehicle also stops, automatically. The **Stopped** message appears on the gauge. When the vehicle ahead of you starts again, the vehicle icon on the gauge blinks. If you press the **RES/+** or **SET/-** button, or depress the accelerator pedal, ACC with Low Speed Follow operates again within the previously set speed.

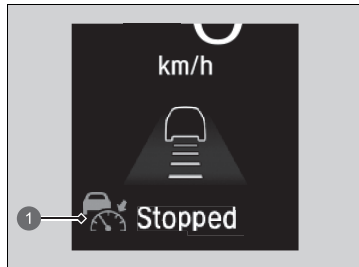

1  Indicator (Green)

If no vehicle is ahead of you before you resume driving, depress the accelerator pedal and ACC with Low Speed Follow will operate again within the prior set speed.

▶ A vehicle detected ahead is within ACC with Low Speed Follow range and slows to a stop

WARNING

Exiting a vehicle that has been stopped while the ACC with Low Speed Follow system is operating can result in the vehicle moving without operator control.

A vehicle that moves without operator control can cause a crash, resulting in serious injury or death.

Never exit a vehicle when the vehicle is stopped by ACC with Low Speed Follow.

■ ACC with Low Speed Follow Conditions and Limitations

The system may automatically shut off under certain conditions. Some examples of these conditions are listed below. Other conditions may reduce some of the ACC functions.

📷 **Front Wide View Camera** P. 468

■ Environmental conditions

- Driving in bad weather (rain, fog, snow, etc.).
- Sudden changes between light and dark, such as the entrance or exit of a tunnel or the shadows of trees, buildings, etc.
- Strong light is reflected onto vehicles or road surfaces.
- Water is sprayed by or snow blown from a vehicle ahead.
- Driving at night or in a dark place such as a tunnel (due to low-light conditions, the whole vehicle may not be illuminated).
- Driving into low sunlight (e.g., at dawn or dusk).

■ Roadway conditions

- Driving on curvy, winding, undulating, or sloping roads.

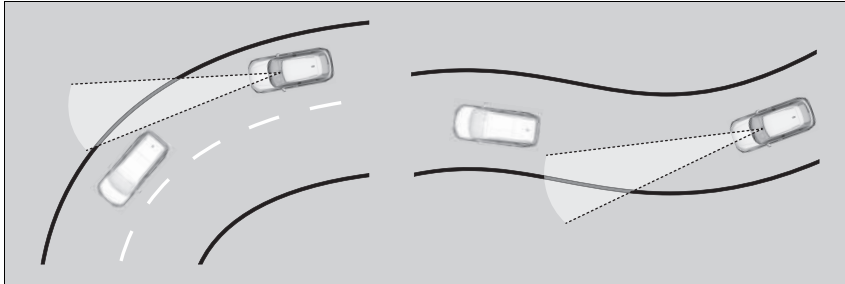

- Driving on rutted roads (snowy or unpaved roads, etc.).
- Puddles or a film of water is on the road surface.
- Your vehicle is strongly shaken on uneven road surfaces.

■ Vehicle conditions

- The vehicle is tilted due to heavy luggage in the luggage area or rear seats.
- Tyre chains are installed.
- The front of the front wide view camera is covered by dirt, fog, rain, mud, wet snow, seals, accessories, stickers, or film of the windscreen.
- Driving at night or in a dark place (e.g., a tunnel) with the headlights off.
- There is residue on the windscreen from the windscreen wipers.
- When lighting is weak due to dirt covering the headlight lenses, or there is poor visibility in a dark place due to the headlights being improperly adjusted.
- Abnormal tyre or wheel condition (incorrect sizes, varied sizes or construction, improperly inflated, etc.).
- The suspension has been modified.

■ **Examples of conditions under which the front wide view camera may not correctly detect the vehicle ahead of you**

- A vehicle suddenly crosses in front of you.
- The interval between your vehicle and the vehicle ahead of you is too short.
- When the vehicle ahead of you blends in with the background, preventing the system from recognising it.
- The headlights of the vehicle ahead of you are lit on one side or not lit on either side in a dark place.

■ **Examples of conditions under which the system may not work properly**

- A vehicle ahead of you stops and the speed difference between your vehicle and the vehicle ahead of you is significantly large.
- When the vehicle ahead of you slows suddenly.
- When a vehicle ahead of you is specially-shaped.
- When a vehicle is lower in the rear than the front such as trucks that are not carrying a load, or a narrow vehicle.

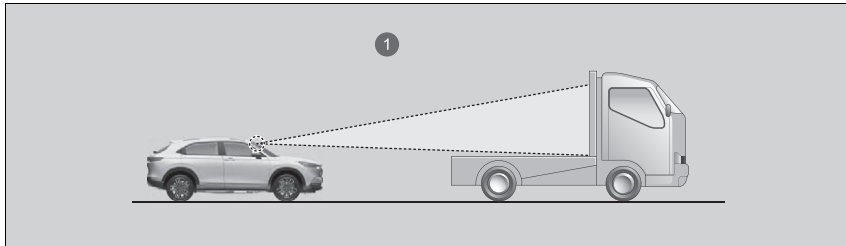

① Front wide view camera detects upper section of an empty carrier lorry.

- When your vehicle or the vehicle ahead of you is driving on the edge of the lane.
- When the vehicle ahead of you is a narrow vehicle such as a motorcycle.
- When the minimum ground clearance of a vehicle ahead of you is extremely high.

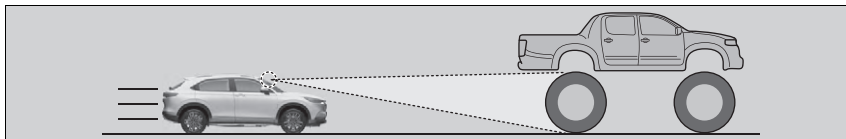

- When the front wide view camera cannot correctly identify the shape of the vehicle ahead of you.

■ To Adjust the Vehicle Speed

Increase or decrease the vehicle speed using the **RES/+** or **SET/-** button on the steering wheel.

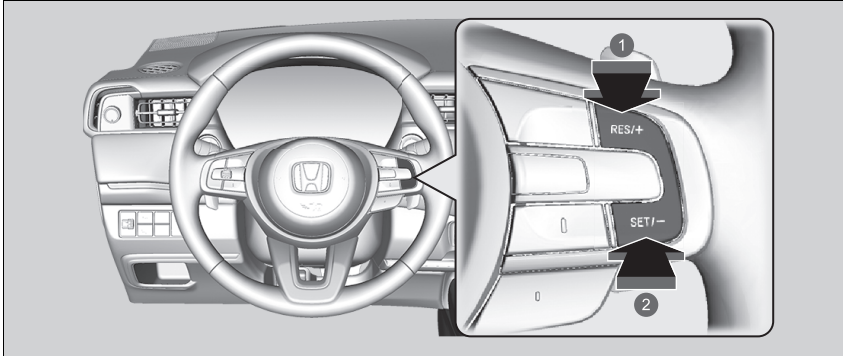

- ① To increase speed
- ② To decrease speed

- Each time you press the **RES/+** or **SET/-** button, the vehicle speed is increased or decreased by about 1 km/h or 1 mph accordingly.
- If you press and hold the **RES/+** or **SET/-** button, the vehicle speed increases or decreases by about 10 km/h or 10 mph accordingly.

☒ To Adjust the Vehicle Speed

If a vehicle detected ahead is going at a speed slower than your increased set speed, ACC with Low Speed Follow may not accelerate your vehicle. This is to maintain the set interval between your vehicle and the vehicle ahead.

When you depress the accelerator pedal and then push and release the **SET/-** button, the current speed of the vehicle is set.

■ To Set or Change Following-interval

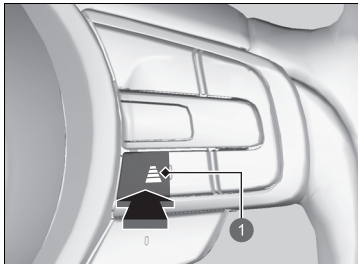





① Interval Button

Press the interval button to change the ACC with Low Speed Follow following-interval. Each time you press the button, the following-interval (the interval behind a vehicle detected ahead of you) setting cycles through extra long, long, middle, and short following-intervals.

Determine the most appropriate following-interval setting based on your specific driving conditions. Be sure to adhere to any following-interval requirements set by local regulation.

The higher your vehicle's following-speed is, the longer the short, middle, long or extra long following-interval becomes. See the following examples for your reference.

Following-interval		When the Set Speed is:	
		80 km/h (50 mph)	104 km/h (65 mph)
Short		26.6 metres 87.3 feet 1.2 sec	33.7 metres 110.6 feet 1.2 sec
Middle		34.6 metres 113.5 feet 1.6 sec	44.9 metres 147.3 feet 1.6 sec
Long		43.9 metres 144.0 feet 2.0 sec	57.1 metres 187.3 feet 2.0 sec
Extra Long		53.6 metres 175.9 feet 2.4 sec	70.0 metres 229.6 feet 2.4 sec

When your vehicle stops automatically because a vehicle detected ahead of you has stopped, the interval between the two vehicles will vary based on the ACC with Low Speed Follow interval setting.

⚠ To Set or Change Following-interval

The driver must in all circumstances preserve a sufficient braking interval from the vehicle which precedes it and be aware that minimum intervals or times of spacing can be provided by the provisions of the Motorway Code locally applicable and that it is the driver's responsibility to respect those laws.

■ To Cancel

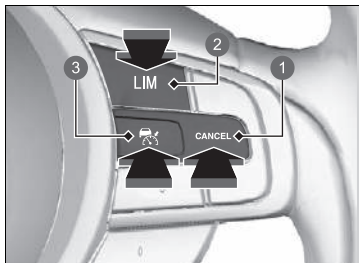

- ① **CANCEL** Button
- ② **LIM** Button
- ③ Button

To cancel ACC with Low Speed Follow, do any of the following:

- Press the **CANCEL** button.
 - ▶ The indicator (green) on the gauge changes to the indicator (white).
- Press the button.
 - ▶ indicator (green) goes off.
- Press the **LIM** button.
 - ▶ The indicator (green) on the gauge changes to the indicator (white).

▶▶ To Cancel

Resuming the prior set speed: After you have cancelled ACC with Low Speed Follow, you can activate the ACC with Low Speed Follow with the prior set speed displayed on the gauge (in gray) by pressing the **RES/+** button even if the vehicle is stopped.

When you turn the ACC with Low Speed Follow off by pressing the **CANCEL** button or depressing the brake pedal, the prior set speed is displayed on the gauge in gray.

When pressing the **RES/+** button, the ACC with Low Speed Follow is activated with displayed speed.

If the indicator (white) is displayed and you press the **RES/+** switch, but no prior set speed (in gray) is displayed, the speed will be set to your vehicle's current speed.





- ① Indicator (White)
- ② Prior Set Speed (Gray)

■ Automatic cancellation

The beeper sounds and a message appears on the gauge when ACC with Low Speed Follow is automatically cancelled. Any of these conditions may cause the ACC with Low Speed Follow to automatically cancel:

- Bad weather (rain, fog, snow, etc.)
- The vehicle ahead of you cannot be detected.
- An abnormal tyre condition is detected, or the tyres are skidding.
- Driving on a mountainous road, or driving off road for extended periods.
- Abrupt steering wheel movement.
- When the ABS, VSA, Low Speed Braking Control, or CMBS is activated.
- When the VSA system indicator comes on.
- When the vehicle is stopped on a very steep slope.
- When you manually apply the parking brake.
- Water is sprayed by or snow blown from a vehicle ahead.
- Driving into low sunlight (e.g., at dawn or dusk).
- When the detected vehicle within the ACC with Low Speed Follow range is too close to your vehicle.
- When accelerating rapidly.
- The front of the front wide view camera is covered by dirt, fog, rain, mud, wet snow, seals, accessories, stickers, or film on the windscreen.
- The vehicle is loaded heavy luggage in the luggage area or rear seats.
- When passing through an enclosed space, such as tunnel.
- When the parking brake and brake system indicator (amber) comes on.
- The vehicle has repeatedly applied the brakes to maintain the set speed (for example, you are descending a long slope).

⌘ To Cancel

The set speed cannot be set or resumed when ACC with Low Speed Follow has been turned off using the  button. Press the  button to activate the system, then set the desired speed.

The ACC with Low Speed Follow automatic cancellation can be also triggered by the following causes. In these cases, the parking brake will be automatically applied.

- The driver's seat belt is unfastened when the vehicle is stationary.
- The vehicle stops for more than 10 minutes.
- The power system is turned off.

Lane Keeping Assist System (LKAS)

Provides steering input to help to keep the vehicle in the middle of a detected lane and provides tactile, audible and visual alerts if the vehicle is detected drifting out of its lane.

■ Steering input assist

The system applies torque to the steering to keep the vehicle between the left and right lane lines. The applied torque becomes stronger as the vehicle gets closer to either of the lane lines.

■ Tactile, audible and visual alerts

Rapid vibrations on the steering wheel, audible and a warning display alert you that the vehicle is drifting out of a detected lane.

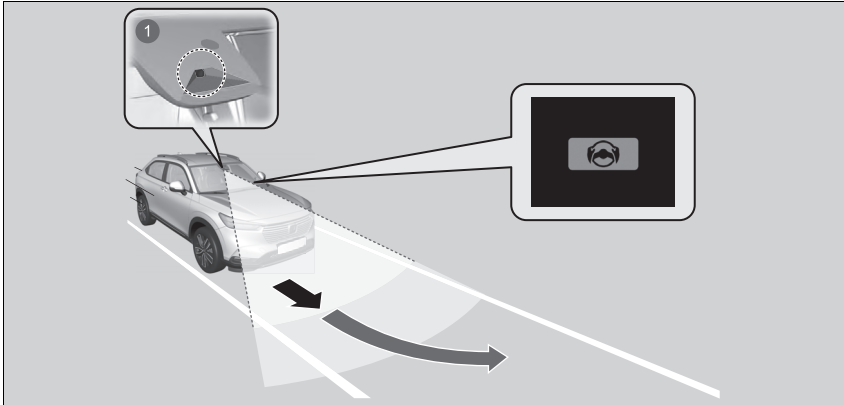

① Front wide view camera: Monitors the lane lines

▣ Lane Keeping Assist System (LKAS)

Important Safety Reminders

The LKAS is for your convenience only. It is not an autonomous driving system and always requires driver attention and control. The system does not work if you take your hands off the steering wheel or fail to steer the vehicle.

The LKAS is convenient when it is used on motorways or a dual carriage way.

Do not place objects on the instrument panel. Objects may reflect on the windscreen and prevent correct detection of the traffic lanes.

The LKAS only alerts you when lane drift is detected without a turn signal in use. The LKAS may not detect all lane markings or lane departures; accuracy will vary based on weather, speed, and lane marker condition.

It is always your responsibility to safely operate the vehicle and avoid collisions.

You can read about handling information for the front wide view camera equipped with this system.

▣ **Front Wide View Camera** P. 468

The LKAS may not work properly or may work improperly under the certain conditions:

▣ **LKAS Conditions and Limitations** P. 449

When you operate the turn signals to change lanes, the system is suspended, and resumes after the signals are off.

If you make a lane change without operating the turn signals, the LKAS alerts activate, and torque is applied to the steering.

▶ Lane Keeping Assist System (LKAS)

When it fails to detect lanes, the system will temporarily be cancelled. When a lane is detected, the system will recover automatically.

■ Lane Keep Support Function

Provides assistance to keep the vehicle in the centre of the lane. When the vehicle nears a white or yellow line, steering force of the electric power steering will become stronger.

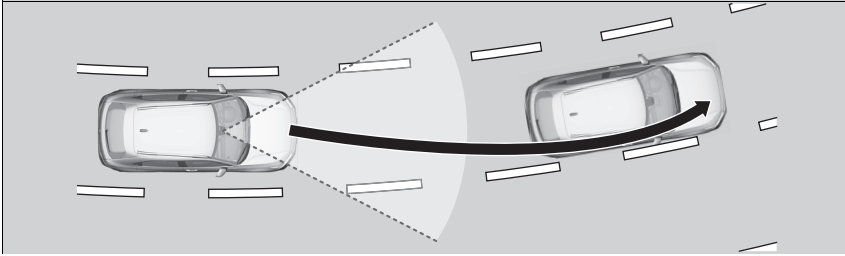

☒ Lane Keeping Assist System (LKAS)

The LKAS may not function as designed while driving in frequent stop and go traffic, or on roads with sharp curves.

Continued

■ Lane Departure Warning Function

When the vehicle enters the warning area, the LKAS alerts you with slight steering wheel vibration, and audible and visual warnings.

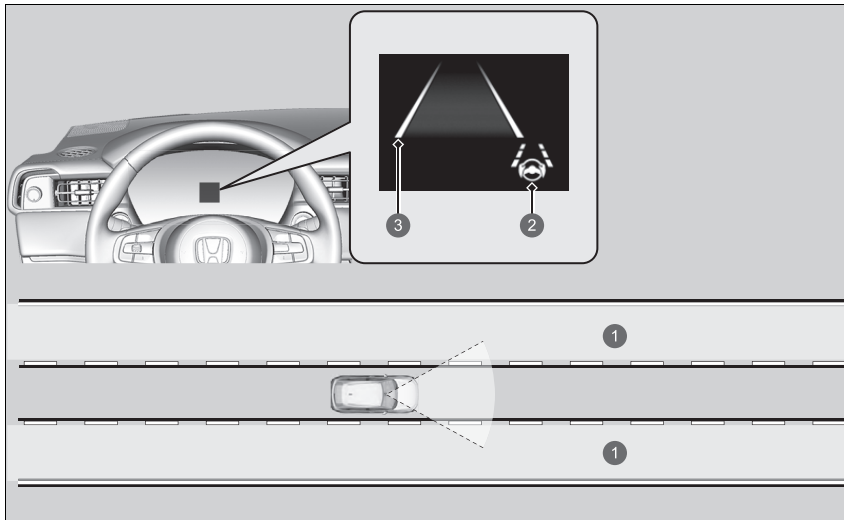

- ① Warning Area
- ② Lane Keeping Assist System (LKAS) Indicator (Green)
- ③ Lane Lines (Amber)

■ When the System can be Used

The system can be used when the following conditions are met.

- The lane in which you are driving has detectable lane markers on both sides, and your vehicle is in the centre of the lane.
- The vehicle is travelling between about 72 and 180 km/h (45 and 112 mph).
- You are driving on a straight or slightly curved road.
- The turn signals are off.
- The brake pedal is not depressed.

■ How to activate the system

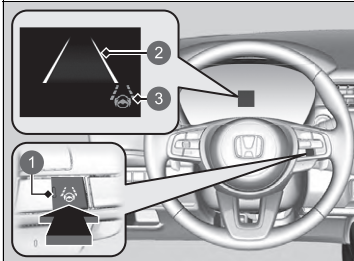

- 1 LKAS Button
- 2 Lane Lines (white)
- 3 Lane Keeping Assist System (LKAS) Indicator (white)

1. Press the LKAS button.

- ▶ LKAS indicator (white) appears on the gauge.

The system is standby.

- ▶ If traffic lane lines are detected, white lines appear on the gauge.

⌘ When the System can be Used

If the vehicle drifts towards either left or right lane line due to the system applying torque, turn off the LKAS and have your vehicle checked by a dealer.

Be sure to keep the following below to activate the system properly;

- Always keep the windscreen around the front wide view camera clean.
- When cleaning the windscreen, be careful not to apply windscreen cleanser to the camera lens.
- Do not touch the front wide view camera lens.
- Do not attach a sticker to the area around the front wide view camera.

If LKAS button is pressed when the system can be used, LKAS is on without standby.

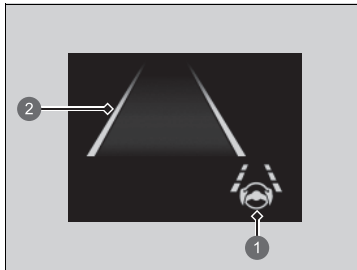

- ① Lane Keeping Assist System (LKAS) Indicator (Green)
- ② Lane Line (Green)

2. Keep your vehicle near the centre of the lane while driving.
 - ▶ The LKAS indicator changes from white to green, and white lines change to green once the system starts operating after detecting the left and right lane markings.

■ To Cancel

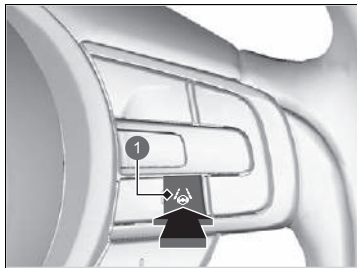

- ① LKAS Button

Press the LKAS button.

The LKAS is turned off every time you turn the power system off, even if you turned it on the last time you drove the vehicle.

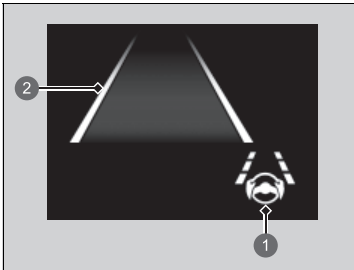

- ① Lane Keeping Assist System (LKAS) Indicator (White)
- ② Lane Lines (White)

When the LKAS is suspended, the lane lines on the gauge change to white, and the beeper sounds (if activated).

■ **The system operation is suspended if you:**

- Depress the brake pedal.
 - ▶ The LKAS resumes and starts detecting the lane lines again once you release the brake pedal.
- Decrease the vehicle speed to about 64 km/h (40 mph) or less.
 - ▶ Increasing the vehicle speed to about 72 km/h (45 mph) or more resumes the LKAS.
- Your vehicle is driving to the right or the left of the lane.

☒ The system operation is suspended if you:

You can change the setting for the LKAS. LKAS suspended beep on and off can be selected.

▶ **Customized Features** P. 304

■ **The LKAS may be automatically suspended when:**

- The system fails to detect lane lines.
 - The steering wheel is turned quickly.
 - You fail to steer the vehicle.
 - Driving through a sharp curve.
 - Driving at a speed in excess of approximately 185 km/h (115 mph).
- Once these conditions no longer exist, the LKAS automatically resumes.

■ **The LKAS may be automatically cancelled when:**

In the following cases, double lane lines may appear on the screen, the beeper may sound, and the LKAS may automatically be cancelled:

- The front wide view camera temperature gets extremely high.
- The front wide view camera behind the rearview mirror, or the area around the front wide view camera, including the windscreen, is dirty.
- The ABS or VSA system engages.

■ LKAS Conditions and Limitations

The system may not detect lane markings and therefore may not keep the vehicle in the middle of the lane under certain conditions, including the following:

■ Environmental conditions

- There is little contrast between lane lines and the roadway surface.
- Driving in bad weather (rain, fog, snow, etc.).
- Driving on a snowy or wet roadway.
- Driving into low sunlight (e.g., at dawn or dusk).
- Shadows of adjacent objects (trees, buildings, guard rails, vehicles, etc.) are parallel to white lines (or yellow lines).
- Sudden changes between light and dark, such as the entrance or exit of a tunnel or the shadows of trees, buildings, etc.
- Driving at night or in a dark place such as a tunnel (due to low-light conditions, lane lines or the road surface may not be illuminated).
- The distance between your vehicle and the vehicle ahead of you is too short, and lane lines and the road surface are not visible.
- Strong light is reflected onto the roadway.

■ Roadway conditions

- Driving on a road with temporary lane markings.
- Faint, multiple, or varied lane markings are visible on the roadway due to road repairs or old lane markings.

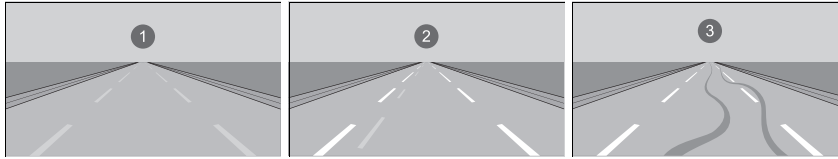

① Faded lines ② Duplicate lines ③ Tyre tracks

- The roadway has merging, split, or crossing lines, such as at an intersection or crosswalk.
- The lane markings are extremely narrow, wide, or changing.

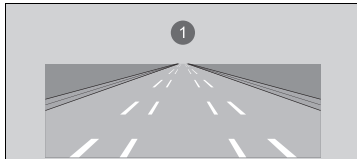

- ① Very wide or narrow traffic lane
- Part of the lane markings are hidden by an object, such as a vehicle.
 - The road is hilly or the vehicle is approaching the crest of a hill.
 - Your vehicle is strongly shaken on uneven road surfaces.
 - When objects on the road (curb, guard rail, pylons, etc.) are recognised as white lines (or yellow lines).
 - Driving on rough or unpaved roads, or over bumpy surfaces.

- Driving on roads with double lane line.
- Driving on snowy or slippery roads.
- The pavement is partially visible due to snow or puddles on the road.
- There is a film of water or puddles on the road surface.
- White lines (or yellow lines) are not recognised correctly due to road conditions such as curves, twists, or hills.
- Driving on unpaved or rutted roads.
- Passing through a junction.

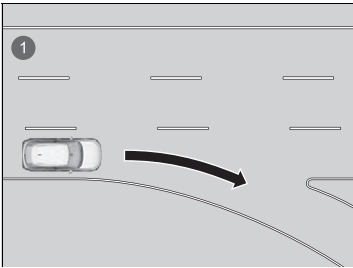

① Lane void of lines at junction

■ **Vehicle conditions**

- When lighting is weak due to dirt covering the headlight lenses, or there is poor visibility in a dark place due to the headlights being improperly adjusted.
- The front of the front wide view camera is covered by dirt, fog, rain, mud, wet snow, seals, accessories, stickers, or film on the windscreen.
- Driving at night or in a dark place (e.g., a tunnel) with the headlights off.
- There is residue on the windscreen from the windscreen wipers.
- Abnormal tyre or wheel condition (incorrect sizes, varied sizes or construction, improperly inflated, etc.).
- The vehicle is tilted due to heavy luggage in the luggage area or rear seats.
- The suspension has been modified.
- Tyre chains are installed.

Road Departure Mitigation System

Alerts and helps to assist you when the system detects a possibility of your vehicle crossing over detected lane markings, or approaching the outer edge of the pavement (into grass or gravel border) or an oncoming vehicle.

How the System Works

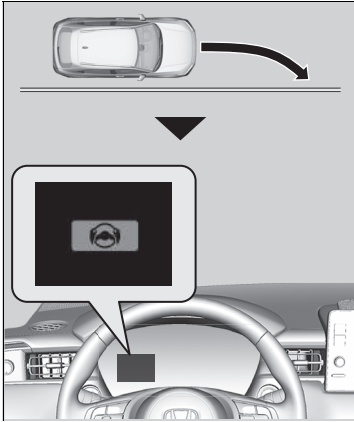

The front wide view camera located at the top of the windshield monitors left and right lane markings in white or yellow, the outer edge of the pavement (bordered by grass or gravel) or oncoming vehicles.

If your vehicle approaches any detected lane markings, the outer edge of the pavement (bordered by grass or gravel) or a detected oncoming vehicles when the turn signals have not been engaged, the system activates.

- ▶ If the system cannot detect lane markings (in white or yellow), no assistance will be provided to avoid approaching oncoming vehicles. In addition to a visual alert, the system assists with steering and alerts you with rapid steering wheel vibrations to help you remain within the detected lane.

▶ **Customized Features** P. 304

As a visual alert,  **Lane Departure** message appears on the driver information interface.

⚠ Road Departure Mitigation System

Important Safety Reminder

Like all assistance systems, the Road Departure Mitigation system has limitations.

Over-reliance on the Road Departure Mitigation system may result in a collision. It is always your responsibility to keep the vehicle within your driving lane.

The Road Departure Mitigation system alerts you when the system detects that you are approaching the outer edge of the pavement (into grass or gravel border), an oncoming vehicle, or drifting into another lane without using a turn signal.

The Road Departure Mitigation system may not detect all lane markings or every instance of lane drift.

The Road Departure Mitigation system may not detect that you are approaching the outer edge of the pavement (bordered by grass or gravel) or an oncoming vehicle.

The Road Departure Mitigation system may not be able to assist you depending on weather, speed or road conditions.

The Road Departure Mitigation system is not activated for about 15 seconds after the power system is turned on.

You can read about handling information for the front wide view camera equipped with this system.

▶ **Front Wide View Camera** P. 468

The system cancels assisting operations when you turn the steering wheel to avoid crossing over detected lane markings or approaching the outer edge of the pavement (into grass or gravel border) or an oncoming vehicle.

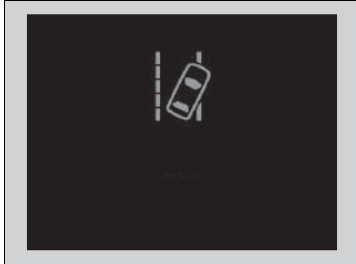

If the system operates several times without detecting driver response, the system beeps to alert you. After that, the Road Departure Mitigation steering assist is temporarily stopped, and the warning sound is given only.

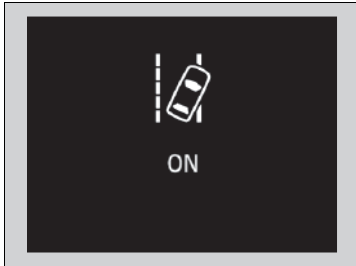

After a few minutes, the message to the left is displayed and the Road Departure Mitigation system is fully restored.

⌘ Road Departure Mitigation System

The Road Departure Mitigation system may not work properly or may work improperly under the certain conditions:

⌘ Road Departure Mitigation system Conditions and Limitations P. 457

There are times when you may not notice the Road Departure Mitigation system functions due to your operation of the vehicle, or road surface conditions.

If LKAS is off and you have selected **Early** or **Normal** from the customized options using the audio/information screen, the message below will appear if the system has determined that there is a possibility of your vehicle crossing over detected lane markings, the outer edge of the pavement (into grass or gravel border) or oncoming vehicle. If you have selected **Delayed**, however, the message will only appear if the vehicle is about to cross over the outer edge of the pavement or oncoming vehicle.

⌘ Customized Features P. 304

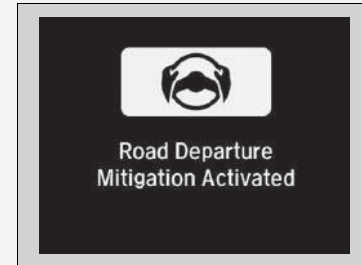

How the System Activates

The system activates when all of the following conditions are met:

- The lane markings is white (yellow).
 - ▶ The vehicle is travelling between about 72 and 180 km/h (45 and 112 mph).
 - ▶ When oncoming vehicles are running
 - ▶ The vehicle is travelling between about 30 and 180 km/h (18 and 112 mph).
- The outer edge of the pavement is grass or gravel border.
 - ▶ The vehicle is travelling between about 30 and 180 km/h (18 and 112 mph).
- The vehicle is on a straight or slightly curved road.
- The turn signals are off.
- The system makes a determination that the driver is not actively accelerating, braking, or steering.

How the System Activates

The Road Departure Mitigation system may automatically shut off and the safety support indicator (amber) comes and stays on.

▶ **Indicators** P. 102

Road Departure Mitigation system function can be impacted when the vehicle is:

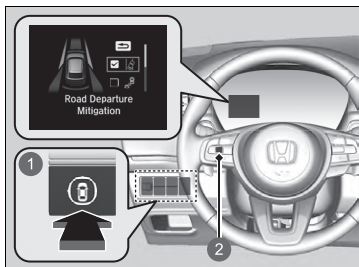

- Driven on the inside edge of a curve, or outside of a lane.
- Driven in a narrow lane.

Road Departure Mitigation system On and Off



- 1 Safety Support Switch
- 2 Left Selector Wheel

When you turn the Road Departure Mitigation system on and off, do the following.

1. Press the safety support switch.
2. Roll the left selector wheel to the  symbol and push it.
 - ▶ A message appears on the driver information interface when the system turns on or off.
 - ▶ A check mark appears in the box and the colour of the  symbol changes to green when the system is on. The check mark disappear and the colour of the  symbol changes to gray when the system is off.

The Road Departure Mitigation system is turned on every time you turn the power system on, even if you turned it off the last time you drove the vehicle.

Road Departure Mitigation system On and Off

You can also select the safety support content from the driver information interface.

▶ **Driver Information Interface** P. 135

The adaptive cruise control (ACC) with low speed follow (amber), vehicle stability assist (VSA) system, vehicle stability assist (VSA) OFF, low tyre pressure/ deflation warning system, and safety support (amber) indicators may come on in amber along with a message in the gauge when you set the power mode to ON after reconnecting the 12-volt battery. Drive a short distance at more than 20 km/h (12 mph). Each indicator should go off. If any do not, have your vehicle checked by a dealer.

■ Road Departure Mitigation system Conditions and Limitations

The system may not properly detect lane markings and the position of your vehicle under certain conditions. Some examples of these conditions are listed below.

■ Environmental conditions

- There is little contrast between lane lines and the roadway surface.
- Driving in bad weather (rain, fog, snow, etc.).
- Driving on a snowy or wet roadway.
- Driving into low sunlight (e.g., at dawn or dusk).
- Shadows of adjacent objects (trees, buildings, guard rails, vehicles, etc.) are parallel to white lines (or yellow lines).
- Sudden changes between light and dark, such as the entrance or exit of a tunnel or the shadows of trees, buildings, etc.
- Strong light is reflected onto the roadway.
- Driving at night or in a dark place such as a tunnel (due to low-light conditions, lane lines, the road surface, or oncoming vehicles may not be illuminated).
- The distance between your vehicle and the vehicle ahead of you is too short, and lane lines and the road surface are not visible.
- The outer edge of the road is bordered by objects, materials, etc. other than grass or gravel.

■ Roadway conditions

- Driving on a road with temporary lane markings.
- Faint, multiple, or varied lane markings are visible on the roadway due to road repairs or old lane markings.
- The roadway has merging, split, or crossing lines, such as at an intersection or crosswalk.
- The lane markings are extremely narrow, wide, or changing.
- Part of the lane markings are hidden by an object, such as a vehicle.
- The road is hilly or the vehicle is approaching the crest of a hill.
- Your vehicle is strongly shaken on uneven road surfaces.
- When objects on the road (curb, guard rail, pylons, etc.) are recognised as white lines (or yellow lines).
- Driving on rough or unpaved roads, or over bumpy surfaces.
- Driving on roads with double lane lines.
- Driving on snowy or slippery roads.
- Passing through a junction.
- The pavement is only partially visible due to snow or puddles on the road.
- Driving on unpaved or rutted roads.
- White lines (or yellow lines) are not recognised correctly due to road conditions such as curves, twists, or hills.

■ Vehicle conditions

- When lighting is weak due to dirt covering the headlight lenses, or there is poor visibility in a dark place due to the headlights being improperly adjusted.
- The front of the front wide view camera is covered by dirt, fog, rain, mud, wet snow, seals, accessories, stickers, or film on the windscreen.
- Driving at night or in a dark place (e.g., a tunnel) with the headlights off.
- When the driver operates the brake pedal and steering wheel.
- There is residue on the windscreen from the windscreen wipers.
- Abnormal tyre or wheel condition (incorrect sizes, varied sizes or construction, improperly inflated, etc.).
- The vehicle is tilted due to heavy luggage in the luggage area or rear seats.
- Tyre chains are installed.
- The suspension has been modified.

■ Examples of limitations on detection due to the condition of oncoming vehicles

- The oncoming vehicle or vehicle ahead of you is sideways.
- The oncoming vehicle jumps out in front of you.
- When the oncoming vehicle blends in with the background, preventing the system from recognising it.
- The headlights of a oncoming vehicle are lit on one side or not lit on either side in a dark place.
- The distance between your vehicle and the oncoming vehicle is too short.
- Part of the oncoming vehicle is not visible due to the vehicle ahead of you.
- There are multiple oncoming lanes or turning lanes.
- The vehicle in the adjacent lane is parked or moving at an extremely slow speed.

■ **Examples of other limitations on detection or system operation**

- When the oncoming vehicle is specially-shaped.
- When the front wide view camera cannot correctly identify the shape of the oncoming vehicle.

■ **With Little Chance of a Collision**

The Road Departure Mitigation system may activate in the below conditions.

- When driving through curves, your vehicle comes to a point where an oncoming vehicle is right in front of you.

Traffic Sign Recognition System

Reminds you of road sign information, such as the current speed limit and that overtaking is prohibited, your vehicle has just passed through, showing it on the gauge.

How the System Works

When the front wide view camera located behind the rearview mirror captures traffic signs while driving, the system displays the ones that are recognised as designated for your vehicle. The sign icon will be displayed until the vehicle reaches a predetermined time and distance.

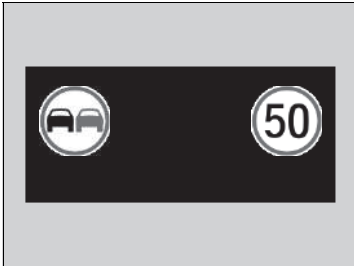

The sign icon also may switch to another one, or disappear when:

- The end of speed limit or other designated limit is detected.
- Your vehicle enters/exits motorway or highway.
- You make a turn with a turn signal at an intersection.

Traffic Sign Recognition System

The system is designed to detect signs that follow the Vienna Convention standards. Not all signs may be displayed, but any signs posted on roadsides should not be ignored. The system does not work on the designated traffic signs of all the countries you travel, nor in all situations.

Do not rely too much on the system. Always drive at speeds appropriate for the road conditions.

Never apply a film or attach any objects to the windshield that could obstruct the front wide view camera's field of vision and cause the system to operate abnormally.

Scratches, nicks, and other damage to the windshield within the front wide view camera's field of vision can cause the system to operate abnormally. If this occurs, we recommend that you replace the windshield with a genuine Honda replacement windshield. Making even minor repairs within the front wide view camera's field of vision or installing an aftermarket replacement windshield may also cause the system to operate abnormally. After replacing the windshield, have a dealer recalibrate the front wide view camera. Proper calibration of the front wide view camera is necessary for the system to operate properly.

The Traffic Sign Recognition System is not activated for about 15 seconds after the power system is turned on.

You can turn the traffic sign recognition system on and off.

▶ **Customized Features** P. 304

Continued

If the system does not detect any traffic signs while you are driving, the image below may appear.



▶ Traffic Sign Recognition System

To help reduce the likelihood that high interior temperatures will cause the front wide view camera's sensing system to shut off, when parking, find a shady area or face the front of the vehicle away from the sun. If you use a reflective sun shade, do not allow it to cover the camera housing. Covering the front wide view camera can concentrate heat on it.

You can read about handling information for the front wide view camera equipped with this system.

▶ **Front Wide View Camera** P. 468

▶▶ Traffic Sign Recognition System

If your vehicle exceeds the detected speed limit, an icon representing the speed limit sign for the current area will blink in the display.

▶▶ Customized Features P. 304

The system's ability to accurately notify the driver of the speed limit is dependent on certain conditions such as the units displayed on the traffic sign as well as the speed and direction of travel of the vehicle. In some cases, the system may display false warnings or other inaccurate information.

▶▶ Traffic Sign Recognition System Conditions and Limitations P. 464

The unit for speed limits (mph or km/h) varies from country to country. Just after entering a country whose unit differs to the one of the country from which you came, Traffic Sign Recognition System may not work correctly.

▶▶ Customized Features P. 304

■ Traffic Sign Recognition System Conditions and Limitations

The Traffic Sign Recognition system may not be able to recognise a traffic sign in the following cases.

■ Environmental conditions

- Driving into low sunlight (e.g., at dawn or dusk).
- Strong light is reflected onto the roadway.
- Driving at night, in dark areas such as long tunnels.
- Driving in bad weather (rain, fog, snow, etc.).
- Sudden changes between light and dark, such as the entrance or exit of a tunnel or the shadows of trees, buildings, etc.
- Water is sprayed by or snow blown from a vehicle ahead.

■ Roadway conditions

- Your vehicle is strongly shaken on uneven road surfaces.

■ Vehicle conditions

- When lighting is weak due to dirt covering the headlight lenses, or there is poor visibility in a dark place due to the headlights being improperly adjusted.
- The front of the front wide view camera is covered by dirt, fog, rain, mud, wet snow, seals, accessories, stickers, or film on the windscreen.
- There is residue on the windscreen from the windscreen wipers.
- Abnormal tyre or wheel condition (incorrect sizes, varied sizes or construction, improperly inflated, etc.).
- The vehicle is tilted due to heavy luggage in the luggage area or rear seats.
- The suspension has been modified.
- Tyre chains are installed.
- Driving at night or in a dark place (e.g., a tunnel) with the headlights off.

▶▶ Traffic Sign Recognition System Conditions and Limitations

When the Traffic Sign Recognition System malfunctions,  appears on the gauge. If this message does not disappear, have your vehicle checked by a dealer.

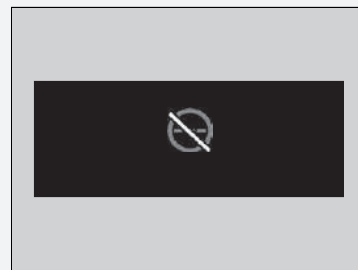

■ The position or the condition of the traffic sign

- The sign is in a place that makes it hard to find.
- The sign is located far away from your vehicle.
- The sign is located where it is hard for headlight beams to reach.
- The sign is on a corner or bend in the road.
- The sign is faded or bent.
- The sign is rotated or damaged signs.
- The sign is covered with mud, snow, or frost.
- Part of the sign is hidden by the trees, or is in the shadow of a vehicle or other object.
- Light (such as a streetlight) is reflected on the surface of the sign, or it is hidden in shadow.
- The sign is too bright or too dark (electric signs).
- Small signs (auxiliary signs, etc.).

■ Other conditions

- When you are driving at a high speed.

The Traffic Sign Recognition System may not operate correctly, such as displaying signs that do not adhere to the actual regulations for the roadway or do not exist at all in the following cases:

- ▶ A speed limit sign may display at a higher or lower speed than the actual speed limit.
- There is a supplementary sign with further information such as weather, time, vehicle type, etc.
- Figures on the sign are hard to read (electric sign, numbers on the signs are blurred, etc.).
- The sign is in the vicinity of the lane you are driving in, even though it is not for the lane, such as a speed limit sign situated at the junction between the side road and the main road.
- There are things that look similar in colour or shape to recognised objects (similar sign, electric sign, signboard, structure, etc.).

■ Signs Displayed on the Gauge

Two traffic signs can be simultaneously displayed next to each other when detected. The speed limit sign icon is displayed on the right half of the screen. The overtaking prohibition sign icon appears on the left. Any additional sign that indicates speed limit based on weather (snow, etc.) or specific period of time can appear on either side.

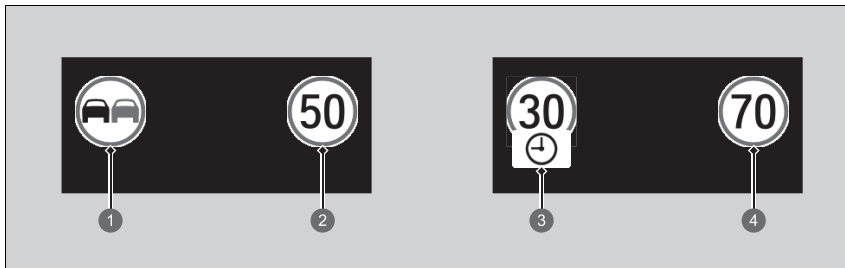

- ① Overtaking Prohibition Sign*¹
- ② Speed Limit Sign
- ③ Additional Speed Limit Sign Based on Conditions*²
- ④ Speed Limit Sign

Depending on situation, *¹ can be replaced with *², or *² can appear on the right side.

Front Wide View Camera

The front wide view camera, used in systems such as Lane Keeping Assist System (LKAS), Road Departure Mitigation System, Adaptive Cruise Control (ACC) with Low Speed Follow, Traffic Sign Recognition System, and Collision Mitigation Braking System (CMBS), is designed to detect an object that triggers any of the systems to operate its functions.

Front Wide View Camera Location and Handling Tips

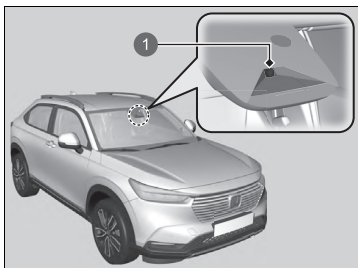

1 Front Wide View Camera

This front wide view camera is located behind the rearview mirror.

To help to reduce the likelihood that high interior temperatures will cause the front wide view camera's sensing system to shut off, when parking, find a shady area or face the front of the vehicle away from the sun. If you use a reflective sun shade, do not allow it to cover the front wide view camera housing. Covering the front wide view camera can concentrate heat on it.

Front Wide View Camera

Never apply a film or attach any objects to the windshield, the bonnet, or the front grille that could obstruct the front wide view camera's field of vision and cause the system to operate abnormally. Scratches, nicks, and other damage to the windshield within the front wide view camera's field of vision can cause the system to operate abnormally. If this occurs, we recommend that you replace the windshield with a genuine Honda replacement windshield. Making even minor repairs within the front wide view camera's field of vision or installing an aftermarket replacement windshield may also cause the system to operate abnormally. After replacing the windshield, have a dealer recalibrate the front wide view camera. Proper calibration of the front wide view camera is necessary for the system to operate properly.

Do not place an object on the top of the instrument panel. It may reflect onto the windshield and prevent the system from detecting lane lines properly.

» Front Wide View Camera

If the  message appears:

- Use the climate control system to cool down the interior and, if necessary, also use demister mode with the air flow directed towards the front wide view camera.
- Start driving the vehicle to lower the windscreen temperature, which cools down the area around the front wide view camera.

If the  **Some Driver Assist System Cannot Operate: Clean Front Windscreen Or Poor Viewing Condition.** message appears:

- Park your vehicle in a safe place, and make sure the windscreen is clean.
Clean the windscreen if it is dirty. If the message does not disappear after driven for a while, have your vehicle checked by a dealer.

Sonar Sensors

■ Location and range of sensors

The sonar sensors are situated in the front and rear bumpers.

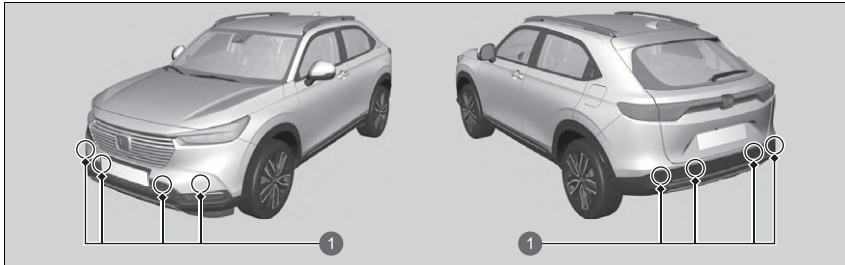

1 Sonar Sensors

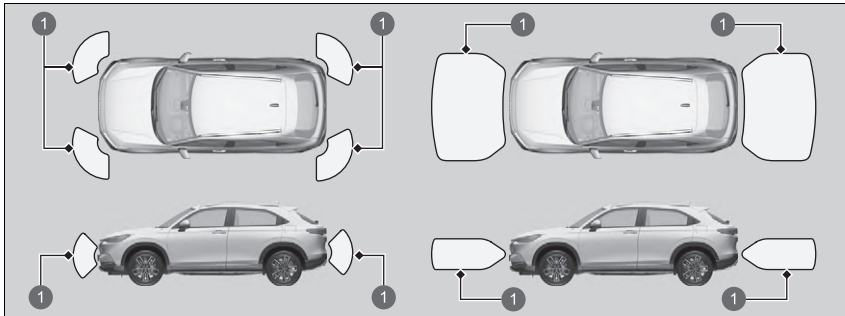

1 Sonar Range

☒ Sonar Sensors

For the sonar sensors to work properly, do not:

- Place stickers or other objects on or around the sensors.
- Hit the area around the sensors.
- Attempt to take apart any sensor.
- Put any accessories on or around the sensors.

Consult with a dealer if:

- A sensor has been subjected to shock.
- Work needs to be done to the area around a sensor.

In the following cases, the sonar sensors may not work properly. Have your vehicle checked by a dealer.

- The front or rear bumper has made contact with a hill, parking block, curb, embankment, etc.
- The vehicle has been involved in frontal or rear collision.
- The vehicle has been driven through a deep puddle.

Brake System

■ Parking Brake

Use the parking brake to keep the vehicle stationary when parked. When the parking brake is applied, you can manually or automatically release it.

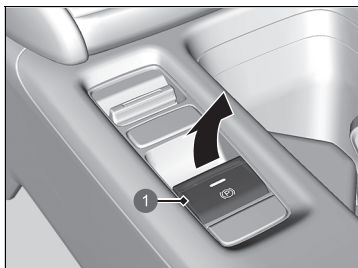

1 Electric Parking Brake Switch

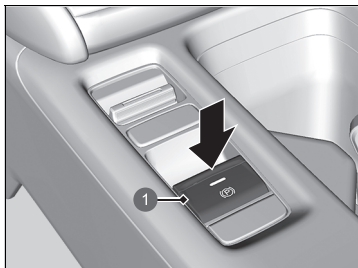

1 Electric Parking Brake Switch

■ To apply

The electric parking brake can be applied any time the vehicle has 12-volt battery, no matter which position the power mode is in.

Pull the electric parking brake switch up gently and securely.

- ▶ The indicator in the switch comes on.
- ▶ The parking brake and brake system indicator (red) comes on.

■ To release

The power mode must be in ON in order to release the electric parking brake.

1. Depress the brake pedal.
2. Press the electric parking brake switch.
 - ▶ The indicator in the switch goes off.
 - ▶ The parking brake and brake system indicator (red) goes off.

Manually releasing the parking brake using the switch helps your vehicle start slowly and smoothly when facing downhill on steep hills.

⊗ Brake System

When you depress the brake pedal, you may hear a whirring sound from the engine compartment. This is because the brake system is in operation, and it is normal.

⊗ Parking Brake

You may hear the electric parking brake system motor operating from the rear wheel area when you apply or release the parking brake. This is normal.

The brake pedal may slightly move due to the electric parking brake system operation when you apply or release the parking brake. This is normal.

You cannot apply or release the parking brake if the 12-volt battery goes dead.

➤ **If the 12-Volt Battery Is Dead** P. 587

If you pull up and hold the electric parking brake switch while driving, the brakes on all four wheels are applied by the electric servo brake system until the vehicle comes to a stop. The electric parking brake then applies, and the switch should be released.

■ Automatic parking brake feature operation

If the automatic parking brake feature has been activated:

- The parking brake is applied automatically when you set the power mode to OFF.
- To confirm that the parking brake is applied, check if the parking brake and brake system indicator is (red) on.

🔧 **Activating and deactivating the automatic parking brake feature** P. 473

■ To release automatically

Depressing the accelerator pedal releases the parking brake.

Use the accelerator pedal to release the parking brake when you are starting the vehicle facing uphill, or in a traffic jam.

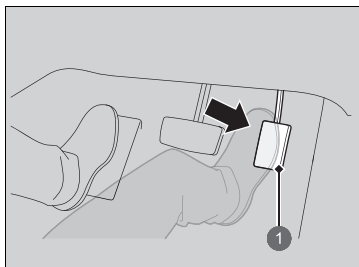

① Accelerator Pedal

Gently depress the accelerator pedal.

When on a hill, it may require more accelerator input to release.

- The parking brake and brake system indicator (red) goes off.

You can release the parking brake automatically when:

- You are wearing the driver's seat belt.
- The power system is on.
- The transmission is not in **P** or **N**.

🔧 Parking Brake

In the following situations, the parking brake automatically operates.

- When the vehicle stops more than 10 minutes while ACC with Low Speed Follow is activated.
- When the driver's seat belt is unfastened while your vehicle is stopped automatically by ACC with Low Speed Follow.
- When the power system is turned off while ACC with Low Speed Follow is activated.
- When the vehicle stops with the automatic brake hold system activated for more than 10 minutes.
- When the driver's seat belt is unfastened while your vehicle is stopped and brake hold is applied.
- When the power system is turned off while brake hold is applied.
- When there is a problem with the Brake Hold System while brake hold is applied.

If the parking brake cannot be released automatically, release it manually.

When the vehicle is travelling uphill, the accelerator pedal may need to be pressed farther to automatically release the electric parking brake.

■ Activating and deactivating the automatic parking brake feature

With the power mode in ON, carry out the following steps to either activate or deactivate the automatic parking brake feature.

1. Put the transmission into **P**.
2. Without depressing the brake pedal, pull up the electric parking brake switch.
 - ▶ Check that the parking brake and brake system indicator has come on.
3. Pull up and hold the parking brake switch. When you hear a beeping sound, release the switch and within 3 seconds pull up and hold the switch again.
4. When you hear a sound indicating that the procedure is completed, release the switch.
 - ▶ Two beeps indicates that the feature has been activated.
 - ▶ One beep indicates that the feature has been deactivated.
 - ▶ When you have completed activating the feature, the parking brake will remain applied after you turn off the power system.
 - ▶ To confirm that the parking brake is applied, check if the parking brake and brake system indicator (red) is on.

If you need to temporarily deactivate the feature while having your vehicle towed, you can follow the procedure explained below.

1. Depress the brake pedal and bring the vehicle to a stop.
2. Set the power mode to OFF and then within 2 seconds push down the electric parking brake switch.
 - ▶ Activation and deactivation settings for the feature will not be affected.
 - ▶ Before temporarily deactivating the feature, make sure to first turn off the automatic brake hold system.
 - ▶ To confirm that the parking brake is applied, check if the parking brake and brake system indicator (red) is on.

☒ Parking Brake

The parking brake cannot be released automatically while the following indicators are on:

- Malfunction indicator lamp
- Transmission system indicator

The parking brake may not be released automatically while the following indicators are on:

- Power system indicator
- Parking brake and brake system indicator (amber)
- VSA system indicator
- **ABS** indicator
- Supplemental restraint system indicator

☒ Activating and deactivating the automatic parking brake feature

In cold climates, the parking brake may freeze in place if applied.

When parking the vehicle, chock the wheels and make sure the automatic parking brake feature is deactivated.

Also, when putting your vehicle through a conveyor-type car wash or when having your vehicle towed, deactivate the automatic parking brake feature and leave the parking brake released.

■ Foot Brake

Your vehicle is equipped with disc brakes at all four wheels. The brake assist system increases the stopping force when you depress the brake pedal hard in an emergency situation. The anti-lock brake system (ABS) helps you to retain steering control when braking very hard.

➤ **Brake Assist System** P. 479

➤ **Anti-lock Brake System (ABS)** P. 478

☒ Foot Brake

Check the brakes after driving through deep water, or if there is a buildup of road surface water. If necessary, dry the brakes by lightly depressing the pedal several times.

If you hear a continuous metallic friction sound when applying the brakes, the brake pads need to be replaced. Have your vehicle checked by a dealer.

Constantly using the brake pedal while going down a long hill builds up heat, which reduces the brake effectiveness. Apply regenerative braking by taking your foot off the accelerator pedal and shifting to position **B**.

Do not rest your foot on the brake pedal while driving, as it will lightly apply the brakes and cause them to lose effectiveness over time and reduce pad life. It will also confuse drivers behind you.

Automatic Brake Hold

Keeps the brake applied after releasing the brake pedal until the accelerator pedal is pressed. You can use this system while the vehicle is temporarily stopped, like at traffic lights and in heavy traffic.

Turning on the system

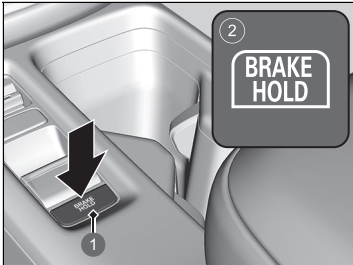

- 1 Automatic Brake Hold Button
- 2 Comes On

Fasten your seat belt properly, then start the power system. Press the automatic brake hold button.

- ▶ The automatic brake hold system indicator comes on. The system is turned on.

The system is in the previously selected on or off setting each time you fasten the driver's seat belt and start the power system.

Automatic Brake Hold

⚠ WARNING

Activating the automatic brake hold system on steep hills or slippery roads may still allow the vehicle to move if you remove your foot from the brake pedal.

If a vehicle unexpectedly moves, it may cause a crash resulting in serious injury or death.

Never activate the automatic brake hold system or rely on it to keep a vehicle from moving when stopped on a steep hill or slippery roads.

⚠ WARNING

Using the automatic brake hold system to park the vehicle may result in the vehicle unexpectedly moving.

If a vehicle moves unexpectedly, it may cause a crash, resulting in serious injury or death.

Never leave the vehicle when braking is temporarily kept by automatic brake hold and always park the vehicle by putting the transmission in **P** and applying the parking brake.

■ Activating the system

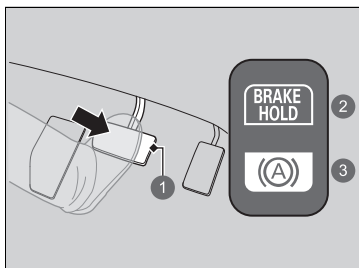

- 1 Brake Pedal
- 2 On
- 3 Comes On

Depress the brake pedal to come to a complete stop. The shift lever must not be in **P** or **R**.

- ▶ The automatic brake hold indicator comes on. Braking is kept for up to 10 minutes.
- ▶ Release the brake pedal after the automatic brake hold indicator comes on.

■ Cancelling the system

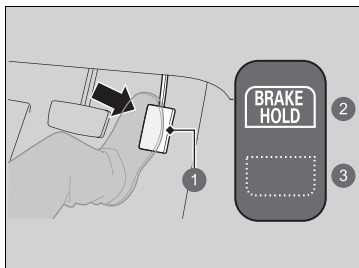

- 1 Accelerator Pedal
- 2 On
- 3 Goes Off

Depress the accelerator pedal while the shift lever is in a position other than **P** or **N**. The system is cancelled and the vehicle starts to move.

- ▶ The automatic brake hold indicator goes off. The system continues to be on.

⌘ Automatic Brake Hold

⚠ WARNING

When using the automatic brake hold, keep your foot on the brake pedal until the automatic brake hold indicator comes on.

If the vehicle unexpectedly moves, it may cause a crash resulting in serious injury or death.

Release your foot from the brake pedal after the automatic brake hold indicator comes on.

■ **The system automatically cancels when:**

- You engage the parking brake.
- You depress the brake pedal and put the transmission into **P** or **R**.

■ **The system automatically cancels and the parking brake is applied when:**

- Braking is kept for more than 10 minutes.
- The driver's seat belt is unfastened.
- The power system is turned off.
- There is a problem with automatic brake hold system.

■ **Turning off the automatic brake hold system**

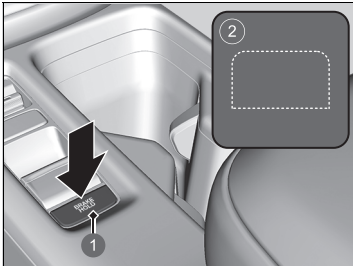

- ① Automatic Brake Hold Button
- ② Goes Off

While the system is on, press the automatic brake hold button again.

- ▶ The automatic brake hold system indicator goes off.

If you want to turn off automatic brake hold while the system is in operation, press the automatic brake hold button with the brake pedal depressed.

⊗ Automatic Brake Hold

While the system is activated, you can turn off the power system or park the vehicle through the same procedure as you normally do.

⊗ **When Stopped** P. 481

You may hear an operating noise if the vehicle moves while the automatic brake hold system is in operation.

⊗ Turning off the automatic brake hold system

Make sure to turn off the automatic brake hold system before using an automated car wash.

If you turn off the power system or unfasten the driver's seat belt while the automatic brake hold system is on, the automatic brake hold system will automatically turn off.

In this case, when the driver's seat belt is fastened and the power system is turned back on, the automatic brake hold system will turn on without needing to press the automatic brake hold button.

Anti-lock Brake System (ABS)

■ ABS

Helps to prevent the wheels from locking up, and helps you to retain steering control by pumping the brakes rapidly, much faster than you can.

The electronic brake distribution (EBD) system, which is part of the ABS, also balances the front-to-rear braking distribution according to vehicle loading.

You should never pump the brake pedal. Let the ABS work for you by always keeping firm, steady pressure on the brake pedal. This is sometimes referred to as "stomp and steer."

■ ABS operation

The brake pedal may pulsate slightly when the ABS is working. Depress the brake pedal and keep holding the pedal firmly down. On dry pavement, you will need to press on the brake pedal very hard before the ABS activates. However, you may feel the ABS activate immediately if you are trying to stop on snow or ice.

ABS may activate when you depress the brake pedal when driving on:

- Wet or snow covered roads.
- Roads paved with stone.
- Roads with uneven surfaces, such as potholes, cracks, manholes, etc.

When the vehicle speed goes under 10 km/h (6 mph), the ABS stops.

⌘ Anti-lock Brake System (ABS)

NOTICE

The ABS may not function correctly if you use a tyre of the incorrect size or type.

If the **ABS** indicator comes on while driving, there may be a problem with the system. While normal braking will not be affected, there is a possibility that the ABS will not be operating. Have your vehicle checked by a dealer immediately.

The ABS is not designed for the purpose of reducing the time or distance it takes for a vehicle to stop: It is designed to limit brake lockup which can lead to skidding and loss of steering control.

In the following cases, your vehicle may need more distance to stop than a vehicle without the ABS:

- You are driving on rough or uneven road surfaces, such as gravel or snow.
- The tyres are equipped with tyre chains.

The following may be observed with the ABS system:

- Motor sounds coming from the engine compartment when the brakes are applied, or when system checks are being performed after the power system has been started and while the vehicle accelerates.
- Brake pedal and/or the vehicle body vibration when ABS activates.

These vibrations and sounds are normal to ABS systems and are no cause for concern.

Brake Assist System

Is designed to assist the driver by generating greater braking force when you depress the brake pedal hard during emergency braking.

■ Brake assist system operation

Press the brake pedal firmly for more powerful braking.

When brake assist operates, the pedal may wiggle slightly and an operating noise may be heard. This is normal. Keep holding the brake pedal firmly down.

Emergency Stop Signal

Activates when you brake hard while driving at 60 km/h (37 mph) or above to alert drivers behind you about sudden braking by rapidly flashing hazard warning lights. This may help to alert drivers behind you to take appropriate means to avoid a possible collision with your vehicle.

■ When the system activates:

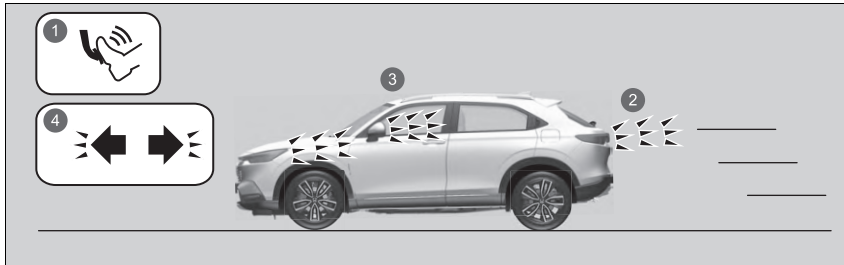

- 1 Hard Braking
- 2 Brake Lights Come On
- 3 Hazard Warning Lights Flash
- 4 Hazard Warning Indicators Blink

The hazard warning lights stop flashing when:

- You release the brake pedal.
- The ABS is deactivated.
- Your vehicle's decelerating speed becomes moderate.
- You press the hazard warning button.

☒ Emergency Stop Signal

The emergency stop signal is not a system that can prevent a possible rear-end collision caused by your hard braking. It flashes the hazard warning lights at the time you are braking hard. It is always recommended to avoid hard braking unless it is absolutely necessary.

The emergency stop signal does not activate with the hazard warning button pressed in.

If the ABS stops working for a certain period during braking, the emergency stop signal may not activate at all.

When Stopped

1. Depress the brake pedal firmly.
2. With the brake pedal depressed, pull up the electric parking brake switch slowly, but fully.
3. Change the shift position to **P**.
4. Turn off the power system.
 - ▶ The parking brake and brake system indicator (red) goes off in about 30 seconds.

Always set the parking brake, in particular if you are parked on an incline.

▣ Parking Your Vehicle

⚠ WARNING

The vehicle can roll away if left unattended without confirming that Park is engaged.

A vehicle that rolls away could cause a crash resulting in serious injury or death.

Always keep your foot on the brake pedal until you have confirmed that **P** is shown on the shift position indicator.

Do not park your vehicle near flammable objects, such as dry grass, oil, or timber. Heat from the exhaust can cause a fire.

Continued

» When Stopped

NOTICE

The following can damage the driveline:

- Depressing the accelerator and brake pedals simultaneously.
- Changing to **P** before the vehicle stops completely.

When facing uphill, do not hold the vehicle by depressing the accelerator pedal.

Doing so may cause the power system to overheat and fail.

In extremely cold temperatures, the parking brake may freeze up if applied. If such temperatures are expected, do not apply the parking brake but, if parking on a slope, either turn the front wheels so they will contact the curb if the vehicle rolls down the slope or block the wheels to keep the vehicle from moving. If you do not take either precaution, the vehicle may roll unexpectedly, leading to a crash.

Parking Sensor System

The corner and centre sensors monitor obstacles around your vehicle, and the beeper, driver information interface and audio/information screen let you know the approximate distance between your vehicle and the obstacle.

■ The sensor location and range

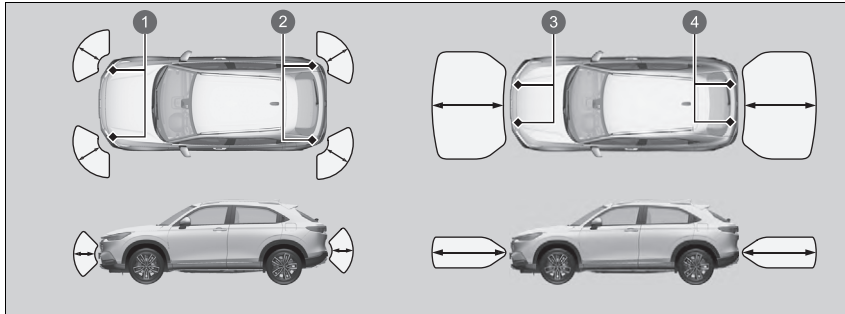

- ① Front Corner Sensors
- ② Rear Corner Sensors
- ③ Front Centre Sensors
- ④ Rear Centre Sensors

▣ Parking Sensor System

Even when the system is on, always confirm if there is no obstacle near your vehicle before parking.

The system may not work properly when:

- The sensors are covered with snow, ice, mud, or dirt.
- The vehicle is on uneven surface, such as grass, bumps, or a hill.
- The vehicle has been out in hot or cold weather.
- The system is affected by devices that emit ultrasonic waves.
- Driving in bad weather.

The system may not sense:

- Thin or low objects.
- Sonic-absorptive materials, such as snow, cotton, or sponge.
- Objects directly under the bumper.

Do not put any accessories on or around the sensors.

When you set the power mode to ON, the system will be in the previously selected condition.

■ Parking sensor system on and off

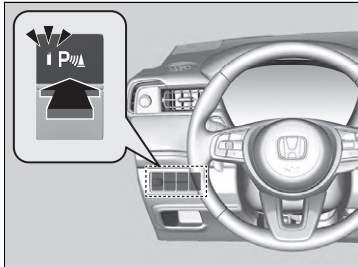

With the power mode in ON, press the parking sensor system button to turn on or off the system. The indicator in the button comes on when the system is on.

The front corner, rear centre and rear corner sensors start to detect an obstacle when the transmission is in **R**, and the vehicle speed is less than 8 km/h (5 mph).

The front corner and front centre sensors start to detect an obstacle when the transmission is in any position other than **P** or **R**, and the vehicle speed is less than 8 km/h (5 mph).

■ Screen Operation

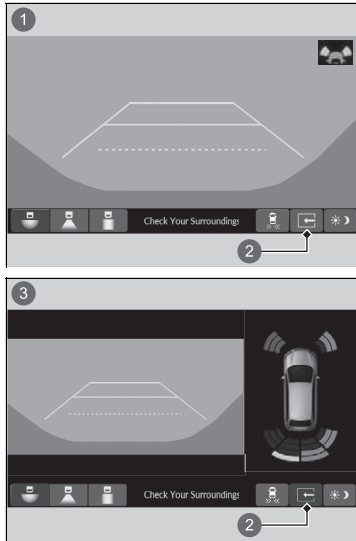

The split screen tab disappears, and the split view returns to the last camera view mode under the following conditions:

- If the parking sensor system is turned off.
- If there is a malfunction in the system.

- 1 Split View Off
- 2 Split Screen Tab
- 3 Split View On

■ When the distance between your vehicle and obstacles becomes shorter

Interval between beeps	Distance between the Bumper and Obstacle		Indicator	Driver information interface/ Audio/information screen
	Corner Sensors	Centre Sensors		
Moderate	—	Front: About 100-60 cm Rear: About 110-60 cm	Yellow*1 Comes on	
Short	About 60-45 cm	About 60-45 cm	Amber Comes on	
Very short	About 45-35 cm	About 45-35 cm		
Continuous	About 35 cm or less	About 35 cm or less	Red Comes on	

*1: At this stage, only the centre sensors detect obstacles.

① Indicators light up where the sensor detects an obstacle.

■ Turning off All Rear Sensors

1. Make sure that the parking sensor system is not activated. Set the power mode to VEHICLE OFF (LOCK).
2. Press and hold the parking sensor system button, and set the power mode to ON.
3. Keep pressing the button for 10 seconds. Release the button when the indicator in the button flashes.
4. Press the button again. The indicator in the button goes off.
 - ▶ The beeper sounds twice. The rear sensors are now turned off.

To turn the rear sensors on again, follow the above procedure. The beeper sounds three times when the rear sensors come back on.

☒ Turning off All Rear Sensors

When you set the shift position to **[R]**, the indicator in the parking sensor system button blinks as a reminder that the rear sensors have been turned off.

Cross Traffic Monitor*

Monitors the rear corner areas using the radar sensors when reversing, and alerts you if a vehicle approaching from a rear corner is detected.

The system is convenient especially when you are getting out of a parking space backwards.

⚠ Cross Traffic Monitor*

⚠ WARNING

Cross traffic monitor cannot detect all approaching vehicles and may not detect an approaching vehicle at all.

Failure to visually confirm that it is safe to back up the vehicle before doing so may result in a collision.

Do not solely rely on the system when reversing; always also use your mirrors, and look behind and to the sides of your vehicle before reversing.

The parking sensor system's alerting buzzer overrides the cross traffic monitor buzzer when the sensors are detecting obstacles at the closest range.

How the System Works

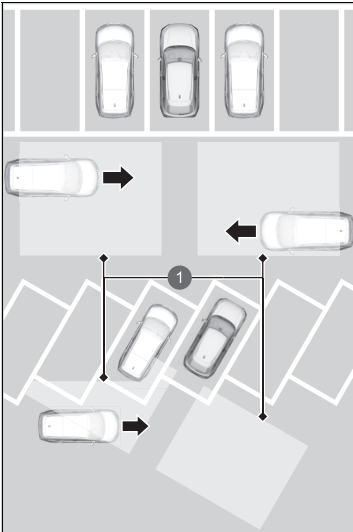

- ① Radar sensors:
Underneath the rear bumper corners.

When a vehicle is detected approaching from a rear corner, Cross Traffic Monitor alerts you with a buzzer and a displayed warning.

The system activates when:

- The power mode is in ON.
- The Cross Traffic Monitor is turned on.
 - ▶ **Cross Traffic Monitor On and Off** P. 492
 - ▶ **Customized Features** P. 304
- The transmission is in **R**.
- Your vehicle is moving at 5 km/h (3 mph) or lower.

⚠ Cross Traffic Monitor*

Cross traffic monitor may not detect or may delay detecting an approaching vehicle, or may alert detection without an approaching vehicle under the following conditions:

- An obstacle, such as another vehicle and a wall, near your vehicle's rear bumper, is blocking the radar sensor's scope.
- Your vehicle is moving at the speed of about 5 km/h (3 mph) or higher.
- A vehicle is approaching at the speed other than between about 10 km/h (6 mph) and 25 km/h (16 mph).
- The system picks up external interference such as other radar sensors from another vehicle or strong radio wave transmitted from a facility nearby.
- Either corner of the rear bumper is covered with snow, ice, mud or dirt.
- When there is bad weather.
- Your vehicle is on an incline.
- Your vehicle is tilted due to a heavy load in the rear.
- Your vehicle is reversing towards a wall, a pole, a vehicle, and so on.

The rear bumper or the sensors have been improperly repaired or the rear bumper has been deformed. Have your vehicle checked by a dealer.

The system will not detect a vehicle that approaches from directly behind your vehicle, nor will it provide alerts about a detected vehicle when it moves directly behind your vehicle.

The system does not provide alerts for a vehicle that is moving away from your vehicle, and it may alert for pedestrians, bicycles, or stationary objects.

📏 Cross Traffic Monitor*

For proper operation, always keep the rear bumper corner area clean. Do not cover the rear bumper corner area with labels or stickers of any kind.

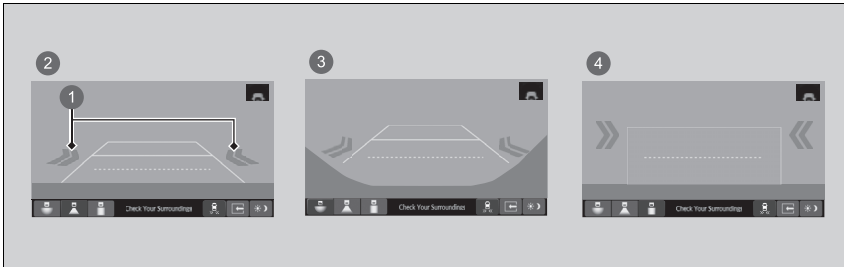

■ When the System Detects a Vehicle



- ① Arrow Icon
- ② Normal View
- ③ Wide View
- ④ Top Down View

An arrow icon appears on the side a vehicle is approaching on the audio/information screen.

⊞ When the System Detects a Vehicle

If the  on the lower right changes to  in amber when the transmission is in **[R]**, mud, snow, ice and other debris may have accumulated in the vicinity of the sensor. The system is temporarily cancelled. Check the bumper corners for any obstructions, and thoroughly clean the area if necessary.

If the  comes on when the transmission is in **[R]**, there may be a problem with the Cross Traffic Monitor system. Do not use the system and have your vehicle checked by a dealer.

If the display remains the same with the transmission in **[R]**, there may be a problem with the rear camera system and the Cross Traffic Monitor system. Do not use the system and have your vehicle checked by a dealer.

■ Cross Traffic Monitor On and Off

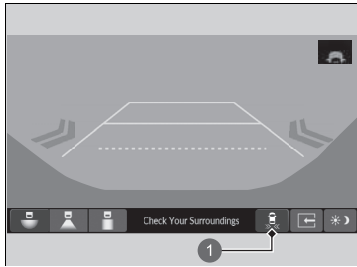

1  Icon

Tap to turn the system on and off. The indicator comes on with the system on. You can also switch the system on and off from the customized feature on the audio/information screen.

➤ **Customized Features** P. 304

About Your Multi-View Rear Camera

The audio/information screen can display your vehicle's rear view. The display automatically changes to the rear view when the transmission is put into **R**.

Multi-View Rear Camera Display Area

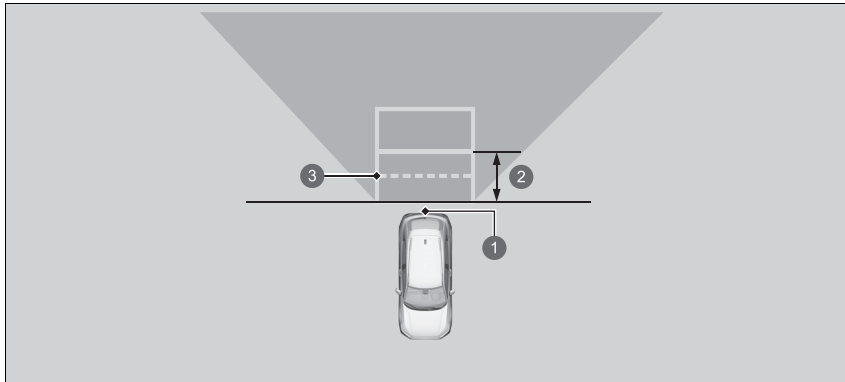

- 1 Camera
- 2 Approx. 1 m (39 inches)
- 3 Tailgate open range

About Your Multi-View Rear Camera



The rear camera view is restricted. You cannot see the corner ends of the bumper or what is underneath the bumper. Its unique lens also makes objects appear closer or farther than they actually are.

Visually confirm that it is safe to drive before backing up. Certain conditions (such as weather, lighting, and high temperatures) may also restrict the rear view. Do not rely on the rearview display which does not give you all information about conditions at the back of your vehicle.

If the camera lens is covered with dirt or moisture, use a soft, moist cloth to keep the lens clean and free of debris.

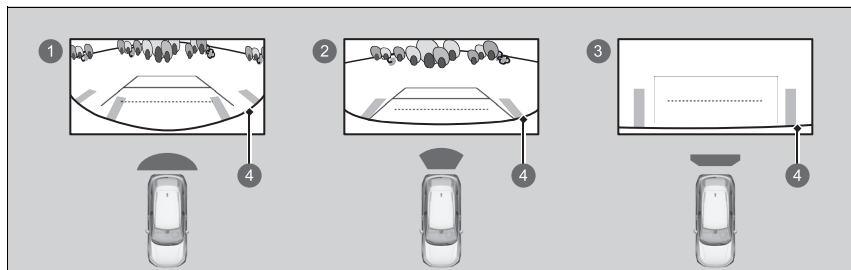
You can view three different camera modes on the audio/information screen. Touch the appropriate icon to switch the mode.



- ①  Wide View Mode
- ②  Normal View Mode
- ③  Top Down View Mode
- ④ Bumper

- If you were last using Wide view mode or Normal view mode, the same view mode will be activated the next time you put the transmission into **R**.
- If you were using Top down view mode before you turned off the power system, Wide view mode will be activated the next time you set the power mode to ON and put the transmission into **R**.
- If you were using Top down view mode and 10 seconds elapsed after you took the transmission out of **R**, Wide view mode will be activated the next time you put the transmission into **R**.

▶ About Your Multi-View Rear Camera

You can change the **Fixed Guideline** and **Dynamic Guideline** settings.

▶ **Customized Features** P. 304

Fixed Guideline

ON: Guidelines appear when you put the transmission into **R**.

OFF: Guidelines do not appear.

Dynamic Guideline

ON: Guidelines move according to the steering wheel direction.

OFF: Guidelines do not move.

Fuel Information

■ Fuel recommendation

EN 228 standards petrol/gasohol fuel

Unleaded premium petrol/gasohol up to E10 (90% petrol and 10% ethanol), research octane number 95 or higher

Your vehicle is designed to operate on premium unleaded petrol with a research octane of 95 or higher.

If this octane grade is unavailable, regular unleaded petrol with a research octane of 91 or higher may be used temporarily.

The use of regular unleaded petrol can cause metallic knocking noises in the engine and will result in decreased engine performance. The long-term use of regular-grade petrol can lead to engine damage.

■ Fuel tank capacity: 40 L (8.8 Imp gal)

☞ Fuel Information

NOTICE

Use of petrol that contains lead presents the following risks:

- Damage to the exhaust system including the catalytic converter
- Damage to the engine and fuel system
- Detrimental effects on the engine and other systems

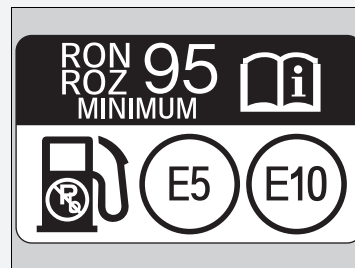

Oxygenated Fuels

Oxygenated fuels are blended with petrol and ethanol or ether compounds. Your vehicle is also designed to operate on oxygenated fuels containing up to 10% ethanol by volume and up to 22% ETBE by volume, based on the EN 228 standards. For more information, ask your dealer.

How to Refuel

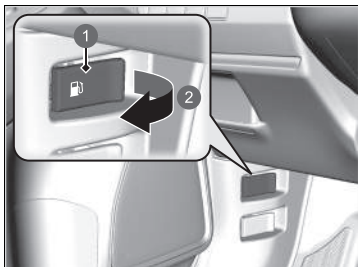

- 1 Fuel Fill Door Release Handle
- 2 Pull

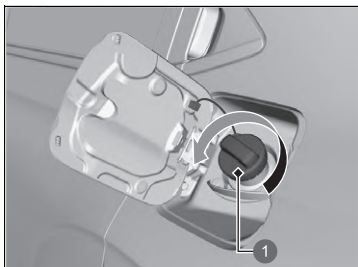

- 1 Cap

1. Stop your vehicle with the service station pump on the left side of the vehicle in the rear.
2. Turn off the power system.
3. Pull on the fuel fill door release handle under the driver's side lower outside corner of the dashboard.
 - ▶ The fuel fill door opens.
4. Remove the fuel fill cap slowly. If you hear a release of air, wait until this stops, then turn the knob slowly to open the fuel fill cap.

How to Refuel

⚠ WARNING

Petrol is highly flammable and explosive. You can be burned or seriously injured when handling fuel.

- Turn the power system off, and keep heat, sparks, and flames away.
- Handle fuel only outdoors.
- Wipe up spills immediately.

The filler nozzle automatically stops to leave space in the fuel tank so that fuel does not overflow as a result of changes in air temperature.

Do not continue to add fuel after the filler nozzle has automatically stopped. Additional fuel can exceed the full tank capacity.

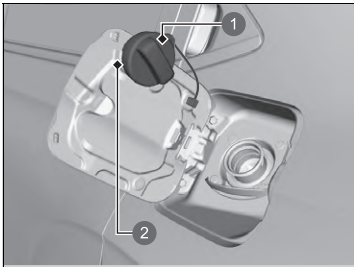

- ① Cap
- ② Holder

5. Place the fuel fill cap in the holder.
6. Insert the fuel filler nozzle fully.
 - ▶ When the tank is full, the filler nozzle will click off automatically. This leaves space in the fuel tank in case the fuel expands with a change in the temperature.
7. After filling, replace the fuel fill cap, tightening it until you hear it click at least once.
 - ▶ Shut the fuel fill door by hand.

Improving Fuel Economy and Reducing CO₂ Emissions

Achieving fuel economy and reducing CO₂ emissions is dependent on several factors, including driving conditions, load weight, idling time, driving habits, and vehicle condition. Depending on these and other factors, you may not achieve the rated fuel economy of this vehicle.

Maintenance and Fuel Economy

You can optimize your fuel economy with proper maintenance of your vehicle. Follow the maintenance schedule and, if necessary, consult your warranty booklet. On vehicles without service reminder system, follow the Maintenance schedule.

📖 Maintenance Schedule* P. 509

- Use engine oil with the viscosity recommended.
 - 📖 Recommended Engine Oil P. 520
- Maintain the specified tyre pressure.
- Do not load the vehicle with excess luggage.
- Keep your vehicle clean. A buildup of snow or mud on your vehicle's underside adds weight and increases wind resistance.

📖 Improving Fuel Economy and Reducing CO₂ Emissions

Direct calculation is the recommended method to determine actual fuel consumed while driving.

100	×	Litres of fuel	÷	Kilometres driven	=	L per 100 km
Miles driven	÷	Gallons of fuel	=	Miles per Gallon		

Maintenance

This chapter discusses basic maintenance.



Before Performing Maintenance

Inspection and Maintenance	500
Safety When Performing Maintenance	501
Parts and Fluids Used in Maintenance	
Service	502
About Your Maintenance Service	503
Service Reminder System *	504
Maintenance Schedule *	509
Maintenance Under the Bonnet	
Maintenance Items Under the Bonnet	517
Opening the Bonnet	518
Recommended Engine Oil	520

Oil Check	522
Adding Engine Oil	523
Cooling System	524
Transmission Fluid	527
Brake Fluid	528
Refilling Window Washer Fluid	529
Fuel Filter	529
Replacing Light Bulbs	530
Checking and Maintaining Wiper Blades	536
Checking and Maintaining Tyres	
Checking Tyres	541
Wear Indicators	542

Tyre Service Life	542
Tyre and Wheel Replacement	543
Tyre Rotation	544
Snow Traction Devices	545
12-Volt Battery	546
Remote Transmitter Care	
Replacing the Remote Battery	552
Climate Control System Maintenance	554
Cleaning	
Interior Care	558
Exterior Care	560
Accessories and Modifications	564

* Not available on all models

Inspection and Maintenance

For your safety, perform all listed inspections and maintenance to keep your vehicle in good condition. If you become aware of any abnormality (noise, smell, insufficient brake fluid, oil residue on the ground, etc.), have your vehicle inspected by a dealer. Refer to the service information available for your vehicle/maintenance schedule in this owner's manual for detailed maintenance and inspection information.

➤ **Maintenance Schedule*** P. 509

Types of Inspection and Maintenance

■ Routine inspections

Perform inspections before long distance trips, when washing the vehicle, or when refueling.

■ Periodic inspections

- Check the brake fluid level monthly.
 - **Brake Fluid** P. 528
- Check the tyre pressure monthly. Examine the tread for wear and foreign objects.
 - **Checking and Maintaining Tyres** P. 541
- Check the operation of the exterior lights monthly.
 - **Replacing Light Bulbs** P. 530
- Check the condition of the wiper blades at least every six months.
 - **Checking and Maintaining Wiper Blades** P. 536

Safety When Performing Maintenance

Some of the most important safety precautions are given here. However, we cannot warn you of every conceivable hazard that can arise in performing maintenance. Only you can decide whether you should perform a given task.

Maintenance Safety

- To reduce the possibility of fire or explosion, keep cigarettes, sparks, and flames away from the 12-volt battery, all High Voltage system, and all fuel related parts.
- Never leave rags, towels, or other flammable objects under the bonnet.
 - ▶ Heat from the engine and exhaust can ignite them, causing a fire.
- To clean parts, use a commercially available degreaser or parts cleaner, not petrol.
- Wear eye protection and protective clothing when working with the 12-volt battery or compressed air.
- Engine exhaust contains carbon monoxide, which is poisonous and can kill you.
 - ▶ Only operate the engine if there is sufficient ventilation.

⚠ Safety When Performing Maintenance

⚠ WARNING

Improperly maintaining this vehicle or failing to correct a problem before driving can cause a crash in which you can be seriously hurt or killed.

Always follow the inspection and maintenance recommendations and schedules in this owner's manual/service information available for your vehicle.

⚠ WARNING

Failure to properly follow maintenance instructions and precautions can cause you to be seriously hurt or killed.

Always follow the procedures and precautions in this owner's manual.

■ Vehicle Safety

- The vehicle must be in a stationary condition.
 - ▶ Make sure your vehicle is parked on level ground, the parking brake is set, and the power system is turned off.
- Be aware that hot parts can burn you.
 - ▶ Make sure to let the power system including the engine and exhaust system cool thoroughly before touching vehicle parts.
- Be aware that moving parts can injure you.
 - ▶ Do not activate the power system unless instructed, and keep your hands and limbs away from moving parts. When the power mode is on, the engine can automatically start, or the radiator fan may start operating without the engine running.
- Do not touch the high-voltage battery and wiring (orange).

Parts and Fluids Used in Maintenance Service

The use of Honda genuine parts and fluids is recommended when maintaining and servicing your vehicle. Honda genuine parts are manufactured according to the same high quality standards used in Honda vehicles.

About Your Maintenance Service

If the service reminder system is available in your vehicle, you are informed by the driver information interface when your vehicle's maintenance services are due. Refer to the service information available for your vehicle for an explanation of the service item codes that appear on the display.

📖 **Service Reminder System*** P. 504

If the service reminder system is not available, follow the maintenance schedules in the service book* that came with your vehicle.

If your vehicle is without the service book*, follow the maintenance schedule in this owner's manual.

📖 **Maintenance Schedule*** P. 509

📖 About Your Maintenance Service

Models with service reminder system

If you are planning to take your vehicle outside the service reminder system applied countries, consult a dealer for how to record your service reminder information and schedule your maintenance service under the conditions of that country.

* Not available on all models

Service Reminder System*



Provides information of which service items are to be performed. Service items are represented by a code and icon. The system tells you when to take your vehicle to a dealer by days remaining.

When the next maintenance service timing is near, coming or passed, a warning icon will also appear on the driver information interface every time you set the power mode to ON.

Service Reminder System*

You can choose to have a corresponding warning message displayed with the warning icon on the driver information interface.

■ Displaying the Service Reminder Information

1. Set the power mode to ON.
2. Press the  (home) button.
3. Roll the left selector wheel until  is displayed.
4. Press the left selector wheel to go to the service reminder information screen. The maintenance item(s) appears on the driver information interface along with maintenance items due soon.

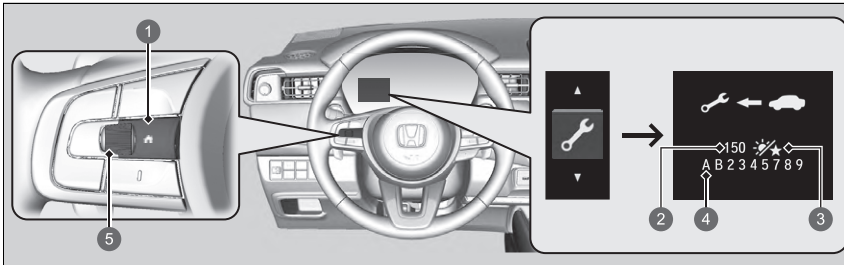







- 1  (home) Button
- 2 Remaining Days
- 3 Day Icon
- 4 Maintenance Item Code(s)
- 5 Left Selector Wheel

The system message indicator (ⓘ) comes on along with the service reminder information.

▣ Displaying the Service Reminder Information

Based on engine operating conditions and engine oil conditions, the system calculates the remaining days before the next service is to be performed.

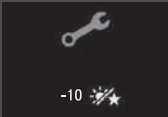
Warning Icons and Service Reminder Information on the Driver Information Interface

Warning Icon	Service Reminder Information	Explanation	Information
<p>Service Due Soon</p> 		<p>One or more of the service items are required in less than 30 days. The remaining days are estimated based on your driving conditions.</p>	<p>The remaining days will be counted down per day.</p>
<p>Service Due Now</p> 		<p>One or more of the service items are required in less than 10 days. The remaining days are estimated based on your driving conditions.</p>	<p>Have the indicated service performed as soon as possible.</p>
<p>Service Over Due</p> 		<p>The indicated maintenance service is still not done after the remaining time reaches 0.</p>	<p>Your vehicle has passed the service required point. Immediately have the service performed and make sure to reset the service reminder system.</p>

■ Service Reminder Items

Service items displayed on the driver information interface are in code and icon. For an explanation of the service reminder codes and icons, refer to the service information available for your vehicle.

■ Availability of the Service Reminder System

Even if the service reminder information appears on the driver information interface while pressing the  (home) button, this system is not available in some countries. Refer to the service information available for your vehicle, or ask a dealer if you can use the service reminder system.



☒ Availability of the Service Reminder System

If you are planning to take your vehicle outside the service reminder system applied countries, consult a dealer on how to record your service reminder information and schedule your maintenance service under the conditions of that country.

Continued

■ Resetting the Display

Reset the service reminder information display if you have performed the maintenance service.

1. Set the power mode to ON.
2. Press the  (home) button.
3. Roll the left selector wheel until  is displayed.
4. Press the left selector wheel to go to the service reminder information screen.
5. Press and hold the left selector wheel until the reset mode is displayed.
6. Roll the left selector wheel to select the item you want to reset (You can also select **Cancel** to end the process).
 - ▶ To reset all items simultaneously, select **All Due Items**.
7. Press the left selector wheel to reset the selected item.
8. Repeat from step 5 for other items you wish to reset.

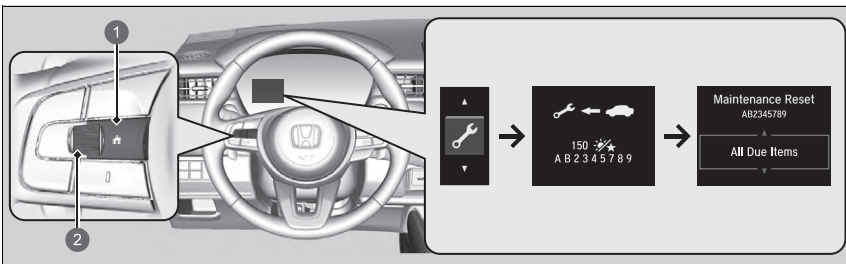

- 1  (home) Button
- 2 Left Selector Wheel

▶▶ Resetting the Display

NOTICE

Failure to reset the service reminder information after a maintenance service results in the system showing incorrect maintenance intervals, which can lead to serious mechanical problems.

You can also reset the service reminder system information display using the audio/information screen.

 **Customized Features** P. 304

The dealer will reset the service reminder information display after completing the required maintenance service. If someone other than a dealer performs maintenance service, reset the service reminder information display yourself.

Maintenance information for your vehicle can be found with the service information for your vehicle (if available). If service information is not available, refer to the following maintenance schedules.

The maintenance schedule outlines the minimum required maintenance that you should perform to ensure the troublefree operation of your vehicle. Due to regional and climatic differences, some additional servicing may be required. Please consult your warranty booklet for a more detailed description.

Maintenance work should be performed by properly trained and equipped technicians. Your authorised dealer meets all of these requirements.

Except Ukrainian models

Service at the indicated distance or time - whichever comes first.	km x 1,000	20	40	60	80	100	120	140	160	180	200
	miles x 1,000	12.5	25.0	37.5	50.0	62.5	75.0	87.5	100.0	112.5	125.0
	months	12	24	36	48	60	72	84	96	108	120
Replace engine oil	Normal	Every 10,000 km (6,000 miles) or 1 year									
	Severe	Every 5,000 km (3,000 miles) or 6 months									
Replace engine oil filter	Normal	Every 20,000 km (12,500 miles) or 2 years									
	Severe	Every 10,000 km (6,000 miles) or 1 year									
Replace air cleaner element	Every 30,000 km (18,500 miles)										
Inspect valve clearance* ¹	Every 120,000 km (75,000 miles)										
Replace spark plugs	Every 100,000 km (62,500 miles)										

*1: Sensory Method

Adjust the valves during service 120,000 km if they are noisy.

Service at the indicated distance or time - whichever comes first.	km x 1,000	20	40	60	80	100	120	140	160	180	200
	miles x 1,000	12.5	25.0	37.5	50.0	62.5	75.0	87.5	100.0	112.5	125.0
	months	12	24	36	48	60	72	84	96	108	120
Replace engine coolant	At 200,000 km (125,000 miles) or 10 years, thereafter every 100,000 km (62,500 miles) or 5 years										
Replace transmission fluid	Normal	Every 150,000 km (93,500 miles) or 6 years									
	Severe	Every 75,000 km (47,000 miles) or 3 years									
Replace dust and pollen filter	•		•		•		•		•		•
Inspect front and rear brakes	Every 10,000 km (6,000 miles) or 1 year										
Replace fuel filter	Normal	Every 180,000 km (112,500 miles)									
	Severe	Every 110,000 km (68,500 miles)* ¹									
Replace brake fluid	Every 3 years										
Check expiry date for tyre repair kit bottle	Every 1 year										
Rotate tyres (Check tyre inflation and condition at least once per month)	Every 10,000 km (6,000 miles)										
Visually inspect the following items:											
Driveshaft boots	Every 10,000 km (6,000 miles) or 1 year										
Tie rod ends, steering gearbox, and boots											
Suspension components											
Brake hoses and lines (including ABS/VSA)	•		•		•		•		•		•
Exhaust system											
Fuel lines and connections											
All fluid levels and condition of fluid											

*1: It is recommended that you replace the fuel filter if the fuel you are using is suspected to be contaminated with dust, etc. because the filter may be clogged sooner.

Ukrainian models

Service at the indicated distance or time - whichever comes first.	km X 1,000	15	30	45	60	75	90	105	120	135	150	165	180	195
	months	12	24	36	48	60	72	84	96	108	120	132	144	156
Replace engine oil	Normal	•	•	•	•	•	•	•	•	•	•	•	•	•
	Severe	Every 7,500 km or 6 months												
Replace engine oil filter	Normal	•	•	•	•	•	•	•	•	•	•	•	•	•
	Severe	Every 7,500 km or 6 months												
Replace air cleaner element	Every 30,000 km													
Inspect valve clearance* ¹	Every 120,000 km													
Replace spark plugs* ²	Every 120,000 km													
Replace engine coolant	At 200,000 km or 10 years, thereafter every 100,000 km or 5 years													
Replace transmission fluid	Every 80,000 km or 4 years													
Replace dust and pollen filter	•	•	•	•	•	•	•	•	•	•	•	•	•	•
Inspect front and rear brakes	•	•	•	•	•	•	•	•	•	•	•	•	•	•
Replace fuel filter	Normal	Every 180,000 km												
	Severe	Every 105,000 km* ³												
Replace brake fluid	Every 3 years													
Check expiry date for tyre repair kit bottle	Every 1 year													
Rotate tyres (Check tyre inflation and condition at least once per month)	Every 15,000 km													
Check lights alignment	•	•	•	•	•	•	•	•	•	•	•	•	•	•

*1: Sensory Method

Adjust the valves during service 120,000 km if they are noisy.

*2: Inspect every 15,000 km

*3: It is recommended that you replace the fuel filter if the fuel you are using is suspected to be contaminated with dust, etc. because the filter may be clogged sooner.

Service at the indicated distance or time	km X 1,000	15	30	45	60	75	90	105	120	135	150	165	180	195
- whichever comes first.	months	12	24	36	48	60	72	84	96	108	120	132	144	156
Test drive (noise, stability, dashboard operation)		•	•	•	•	•	•	•	•	•	•	•	•	•

Visually inspect the following items:

Driveshaft boots														
Tie rod ends, steering gearbox, and boots														
Suspension components														
Brake hoses and lines (including ABS/VSA)	•	•	•	•	•	•	•	•	•	•	•	•	•	•
Exhaust system														
Fuel lines and connections														
All fluid levels and condition of fluid														

If you drive your vehicle under severe conditions, you must have the following items served to the maintenance schedule indicated as Severe.

Items	Condition
Engine oil and oil filter	A, B, C, D and E
Transmission fluid*1	B, D

*1: Except Ukrainian models

►► Maintenance Schedule*

- The condition is considered as severe when you drive:
- A. Less than 8 km (5 miles), or less than 16 km (10 miles) in freezing temperatures per trip.
 - B. In extremely hot temperature above 35°C.
 - C. With extensive idling or long periods of stop-and-go.
 - D. With a loaded roof rack, or in mountains.
 - E. On muddy, dusty or de-iced roads.

Maintenance Record (on vehicles without separate service record)

Have your servicing dealer record all required maintenance below. Keep receipts for all work done on your vehicle.

Except Ukrainian models

Km or Month	Date	Sign or Stamp
20,000 km 12,500 Mi. (or 12 Mo.)		
40,000 km 25,000 Mi. (or 24 Mo.)		
60,000 km 37,500 Mi. (or 36 Mo.)		
80,000 km 50,000 Mi. (or 48 Mo.)		
100,000 km 62,500 Mi. (or 60 Mo.)		
120,000 km 75,000 Mi. (or 72 Mo.)		
140,000 km 87,500 Mi. (or 84 Mo.)		
160,000 km 100,000 Mi. (or 96 Mo.)		
180,000 km 112,500 Mi. (or 108 Mo.)		
200,000 km 125,000 Mi. (or 120 Mo.)		

Ukrainian models

	Km or Month	Date	Sign or Stamp
	15,000 km (or 12 Mo.)		
	30,000 km (or 24 Mo.)		
	45,000 km (or 36 Mo.)		
	60,000 km (or 48 Mo.)		
	75,000 km (or 60 Mo.)		
	90,000 km (or 72 Mo.)		
	105,000 km (or 84 Mo.)		
	120,000 km (or 96 Mo.)		
	135,000 km (or 108 Mo.)		
	150,000 km (or 120 Mo.)		
	165,000 km (or 132 Mo.)		
	180,000 km (or 144 Mo.)		
	195,000 km (or 156 Mo.)		

Maintenance Items Under the Bonnet

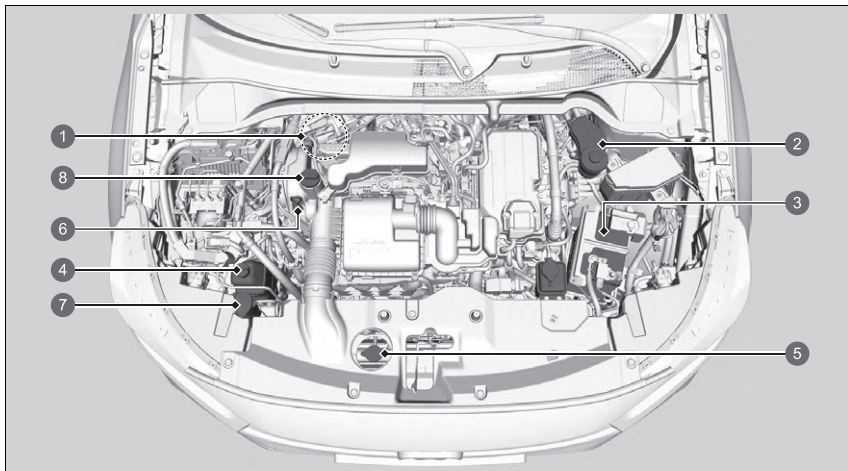

- ① Brake Fluid (Black Cap) (Right-hand Drive Type)
- ② Brake Fluid (Black Cap) (Left-hand Drive Type)
- ③ 12-volt Battery
- ④ Engine Coolant Reserve Tank
- ⑤ Radiator Cap
- ⑥ Engine Oil Dipstick (Orange)
- ⑦ Washer Fluid (Blue Cap)
- ⑧ Engine Oil Fill Cap

Opening the Bonnet

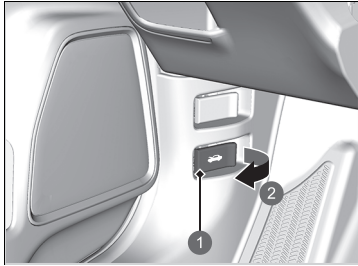

- 1 Bonnet Release Handle
- 2 Pull

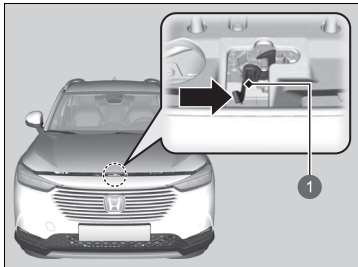

- 1 Lever

1. Park the vehicle on a level surface, and set the parking brake.
2. Pull the bonnet release handle under the driver's side lower outside corner of the dashboard.
 - The bonnet will pop up slightly.

3. Push the bonnet latch lever (located under the front edge of the bonnet to the centre) to the side and raise the bonnet. Once you have raised the bonnet slightly, you can release the lever.

Opening the Bonnet

NOTICE

Do not open the bonnet when the wiper arms are raised. The bonnet will strike the wipers, resulting in possible damage to the bonnet and/or the wipers.

When closing the bonnet, check that the bonnet is securely latched.

If the bonnet latch lever moves stiffly, or if you can open the bonnet without lifting the lever, the latch mechanism should be cleaned and lubricated.

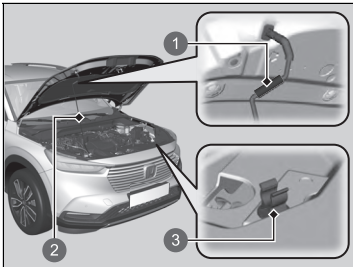

- ❶ Grip
- ❷ Support Rod
- ❸ Clamp

4. Remove the support rod from the clamp using the grip. Mount the support rod in the bonnet.

When closing, remove the support rod, and stow it in the clamp, then gently lower the bonnet. Remove your hand at a height of approximately 30 cm (12 inches) and let the bonnet close.

Recommended Engine Oil

Use a genuine engine oil or another commercial engine oil of suitable type and viscosity (for the ambient temperature) as shown in the image that follows.

Oil is a major contributor to your engine's performance and longevity. If you drive the vehicle with insufficient or deteriorated oil, the engine may fail or be damaged.

Recommended Engine Oil

Engine Oil Additives
You cannot use Engine Oil Additives.

European and Ukrainian models

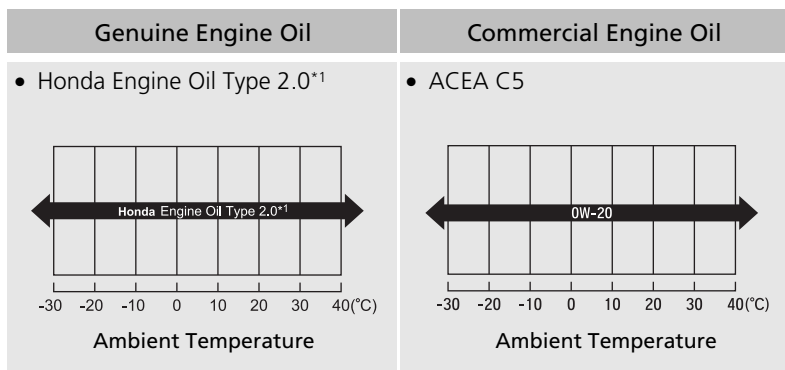

*1: Formulated to improve fuel economy.

Except European and Ukrainian models

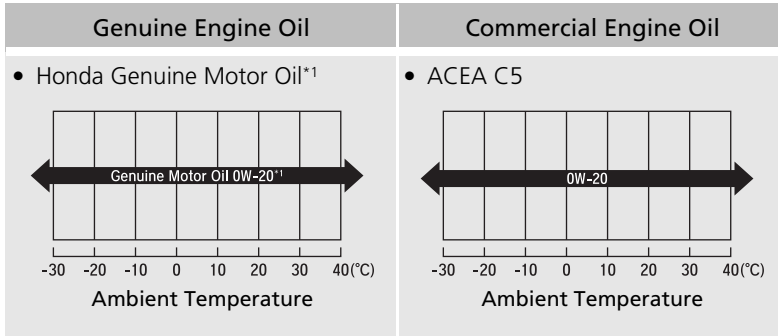

* 1: Formulated to improve fuel economy.

Oil Check

We recommend that you check the engine oil level every time you refuel. Park the vehicle on level ground.

Turn off the power system. You can check the oil level without the engine having run beforehand. If the engine has been running, wait approximately three minutes before you check the oil.

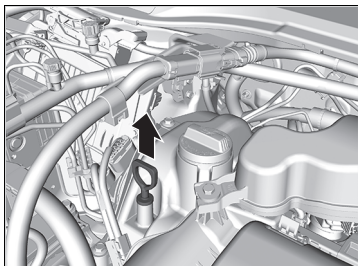

1. Remove the dipstick (orange).
2. Wipe the dipstick with a clean cloth or paper towel.
3. Insert the dipstick back all the way into its hole.

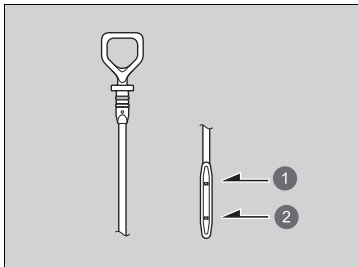

- 1 Upper Mark
- 2 Lower Mark

Oil Check

If the oil level is near or below the lower mark, slowly add oil, being careful not to overfill.

The amount of oil consumed depends on how the vehicle is driven and the climatic and road conditions encountered. The rate of oil consumption can be up to 1 litre per 1,000 km/625 miles. Consumption is likely to be higher when the engine is new.

4. Remove the dipstick again, and check the level. It should be between the upper and lower marks. Add oil if necessary.

Adding Engine Oil

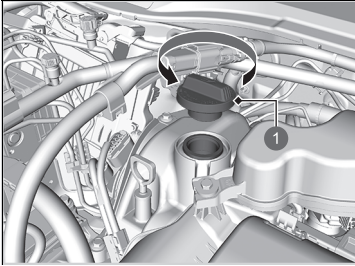

1 Engine Oil Fill Cap

1. Unscrew and remove the engine oil fill cap.
2. Add oil slowly.
3. Reinstall the engine oil fill cap, and tighten it securely.
4. Wait for three minutes and recheck the engine oil dipstick.

Adding Engine Oil

NOTICE

Do not fill the engine oil above the upper mark. Overfilling the engine oil may result in leaks and engine damage.

If any oil spills, wipe it away immediately. Spilled oil may damage the engine compartment components.

Cooling System

Specified coolant: Honda All Season Antifreeze/Coolant Type 2

This coolant is premixed with 50% antifreeze and 50% water. Do not add any straight antifreeze or water.

We recommend you check the engine coolant level every time you refuel. Check the reserve tank first. If it is completely empty, also check the coolant level in the radiator. Add the engine coolant accordingly.

Reserve Tank

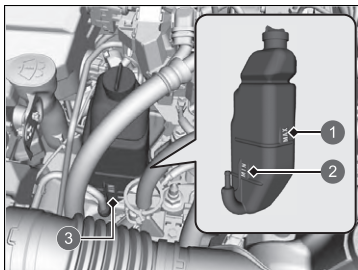

- 1 MAX
- 2 MIN
- 3 Reserve Tank

1. Make sure the engine and radiator are cool.

2. Check the amount of coolant in the reserve tank.

► If the coolant level is below the **MIN** mark, add the specified coolant until it reaches the **MAX** mark.

Cooling System

⚠ WARNING

Removing the radiator cap while the engine is hot can cause the coolant to spray out, seriously scalding you.

Always let the engine and radiator cool down before removing the radiator cap.

NOTICE

If temperatures consistently below -30°C are expected, the coolant mixture should be changed to a higher concentration. Consult your Honda dealer for details about a suitable coolant mixture.

If Honda antifreeze/coolant is not available, you may use another major brand of non-silicate coolant as a temporary replacement. Check that it is a high quality coolant recommended for aluminium engines. Continued use of any non-Honda coolant can result in corrosion, causing the cooling system to malfunction or fail. Have the cooling system flushed and refilled with Honda antifreeze/coolant as soon as possible.

Do not add rust inhibitors or other additives to your vehicle's cooling system. They may not be compatible with the coolant or with the engine components.

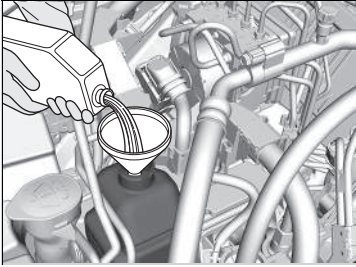

3. Inspect the cooling system for leaks.

■ Radiator

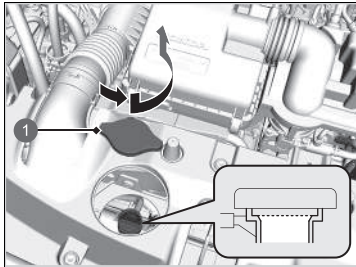

① Radiator Cap

1. **Make sure the engine and radiator are cool.**
2. Turn the radiator cap 1/8 turn anti-clockwise and relieve any pressure in the cooling system.
3. Push down and turn the radiator cap anti-clockwise to remove it.
4. The coolant level should be up to the base of the filler neck. Add coolant if it is low.
5. Put the radiator cap back on, and tighten it fully.

■ Radiator Cap



- Never open when hot.
- Hot coolant will scald you.
- Relief pressure valve begins to open at 108 kPa.

►► Radiator

NOTICE

Pour the fluid slowly and carefully so you do not spill any. Clean up any spills immediately; they can damage components in the engine compartment.

Transmission Fluid

Specified fluid: Honda ATF DW-1

Have a dealer check the fluid level and replace if necessary.
Follow your vehicle's maintenance service timing of when to change transmission fluid.

📄 **Maintenance Schedule*** P. 509

Do not attempt to check or change the transmission fluid yourself.

Transmission Fluid

NOTICE

Do not mix Honda ATF DW-1 with other transmission fluids.

Using a transmission fluid other than Honda ATF DW-1 may adversely affect the operation and durability of your vehicle's transmission, and damage the transmission.

Any damage caused by using a transmission fluid that is not equivalent to Honda ATF DW-1 is not covered by Honda's new vehicle limited warranty.

* Not available on all models

Brake Fluid

Specified fluid: Brake Fluid with DOT 3 or DOT 4

■ Checking the Brake Fluid

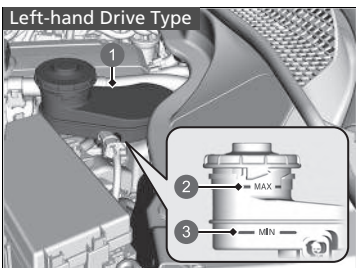

- ① Reserve Tank
- ② **MAX**
- ③ **MIN**

The fluid level should be between the **MIN** and **MAX** marks on the side of the reserve tank.

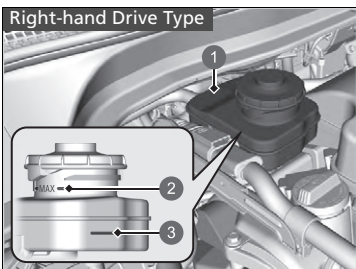

- ① Reserve Tank
- ② **MAX**
- ③ **MIN**

►► Brake Fluid

NOTICE

Brake fluid marked DOT 5 is not compatible with your vehicle's braking system and can cause extensive damage.

We recommend using a genuine product.

If the brake fluid level is at or below the **MIN** mark, have a dealer inspect the vehicle for leaks or worn brake pads as soon as possible.

Refilling Window Washer Fluid

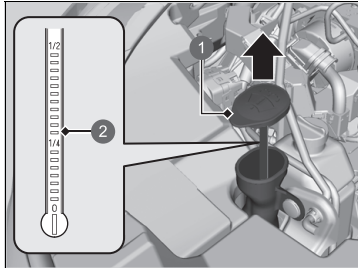

- ① Cap
- ② Level Gauge

Check the amount of window washer fluid using the washer fluid level gauge on the cap.

If the level is low, fill the washer reservoir.

Pour the washer fluid carefully. Do not overflow the reservoir.

Fuel Filter

Replace fuel filter according to the time and distance recommendations in the maintenance schedule.

Have a qualified technician change the fuel filter. Fuel in the system can spray out and create a hazard if all fuel line connections are not handled correctly.

✕ Refilling Window Washer Fluid

NOTICE

Do not use engine antifreeze or a vinegar/water solution in the windscreen washer reservoir. Antifreeze can damage your vehicle's paint. A vinegar/water solution can damage the windscreen washer pump.

Use only commercially available windscreen washer fluid.

Avoid prolonged use of hard water to prevent lime scale buildup.

✕ Fuel Filter

Models with service reminder system

The fuel filter should be replaced according to the service reminder indication.

Headlights

Headlights are LED type. Have an authorised Honda dealer inspect and replace the light assembly.

Front Fog Lights*

Front fog lights are LED type. Have an authorised Honda dealer inspect and replace the light assembly.

Position/Daytime Running Lights

Position/daytime running lights are LED type. Have an authorised Honda dealer inspect and replace the light assembly.

Front Turn Signal Lights

Front turn signal lights are LED type. Have an authorised Honda dealer inspect and replace the light assembly.

Active Cornering Lights*

Active cornering lights are LED type. Have an authorised Honda dealer inspect and replace the light assembly.

Side Turn Signal/Emergency Indicator Lights

Door mirror side turn lights are LED type. Have an authorised Honda dealer inspect and replace the light assembly.

Headlights

The headlight aim is set by the factory, and does not need to be adjusted. However, if you regularly carry heavy items in the luggage area, have the aiming readjusted at a dealer or by a qualified technician.

Brake/Taillights and Rear Turn Signal Light Bulbs

When replacing, use the following bulbs.

Brake Light: LED
Taillight: LED
Rear Turn Signal Light: 21 W (Amber)

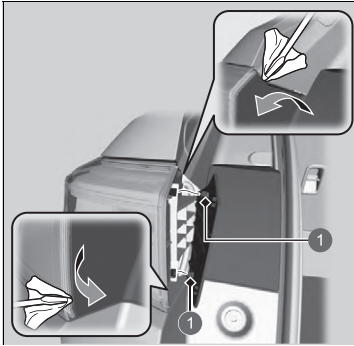

1 Pins

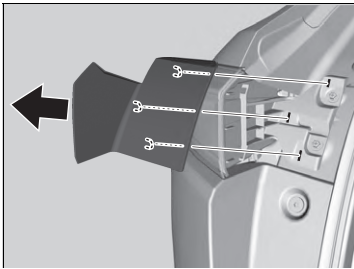

1. Insert the flat-tip screwdriver between the upper end of the cover and the vehicle body, then remove the pin.
 - ▶ Wrap the flat-tip screwdriver with a cloth to prevent scratching the vehicle body.
2. Insert the flat-tip screwdriver between the lower end of the cover and the light assembly, then remove the pin.
 - ▶ Wrap the flat-tip screwdriver with a cloth to prevent scratching the light assembly.
3. Remove the cover by pulling it in the direction of the arrow in the image.

▶▶ Brake/Taillights and Rear Turn Signal Light Bulbs

Brake/taillights are LED type. Have an authorised Honda dealer inspect and replace the light assembly.

Continued

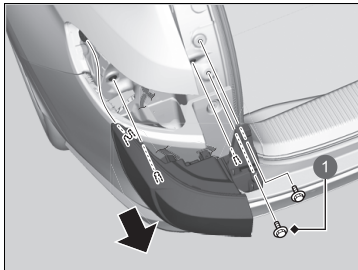

1 Bolts

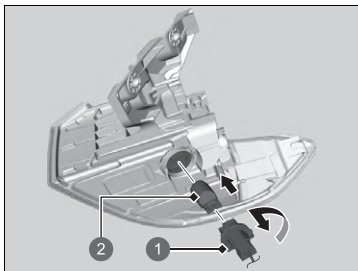

1 Socket

2 Bulb

4. Remove the bolts.
5. Remove the light assembly by pulling it in the direction of the arrow in the image.

6. Turn the socket anticlockwise and remove it. Remove the old bulb.
7. Insert a new bulb.

Taillights, Rear Fog Light, and Back-Up Light Bulbs

When replacing, use the following bulbs.

Taillight: LED
Rear Fog Light: LED
Back-Up Light: 16 W

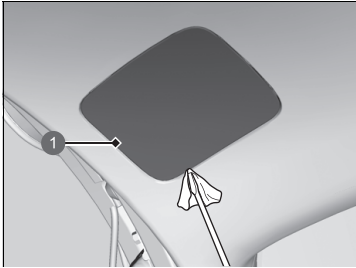

1 Cover

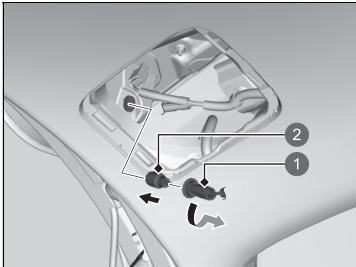

1 Socket
 2 Bulb

1. Remove the cover by prying on the edge using a flat-tip screwdriver.
 - ▶ Wrap the flat-tip screwdriver with a cloth to prevent scratches.

2. Turn the socket anticlockwise and remove it. Remove the old bulb.
3. Insert a new bulb.

⊠ Taillights, Rear Fog Light, and Back-Up Light Bulbs

Taillights and rear fog light are LED type. Have an authorised Honda dealer inspect and replace the light assembly.

Rear Licence Plate Light

Rear licence plate light is LED type. Have an authorised Honda dealer inspect and replace the light assembly.

High-Mount Brake Light

High-mount brake light is LED type. Have an authorised Honda dealer inspect and replace the light assembly.

Other Light Bulbs

■ Vanity Mirror Light Bulbs

Have an authorised Honda dealer inspect and replace the light bulbs.

Checking Wiper Blades

If the wiper blade rubber has deteriorated, it will leave streaks, become noisy, and the hard surfaces of the blade may scratch the window glass.

Changing the Front Wiper Blade Rubber

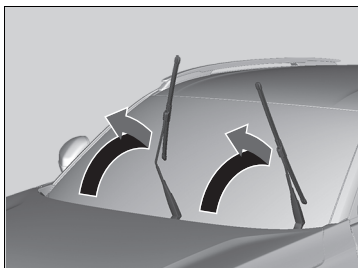

1. Lift the driver side wiper arm first, then the passenger side.

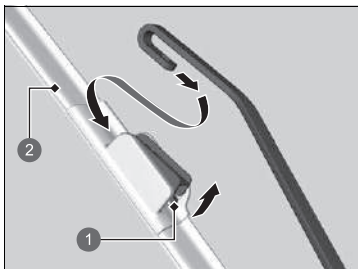

2. Press up on and hold the tab, then slide the holder off the wiper arm.

- 1 Tab
- 2 Holder

Changing the Front Wiper Blade Rubber

NOTICE

Avoid dropping the wiper arm onto the windshield, it may damage the wiper arm and/or the windshield.

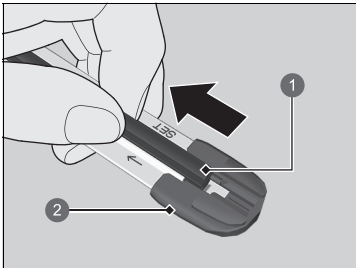

- ❶ Wiper Blade
- ❷ End Cap at the bottom

3. Pull the end of the wiper blade in the direction of the arrow in the image until it is out of the holder's end cap.

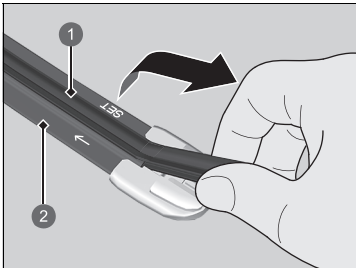

- ❶ Wiper Blade
- ❷ Holder

4. Pull the wiper blade in the opposite direction to slide it out of the holder.

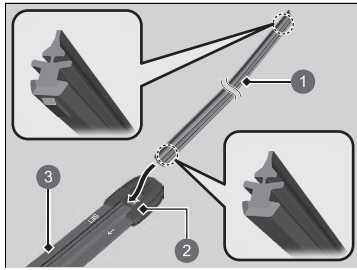

- ① Wiper Blade
- ② Cap
- ③ Holder

5. Insert the flat side of the new wiper blade onto the bottom part of the holder. Insert the blade all the way.
6. Install the end of the wiper blade into the cap.
7. Slide the holder onto the wiper arm until it locks.
8. Lower the passenger side wiper arm first, then the driver side.

Changing the Rear Wiper Blade Rubber

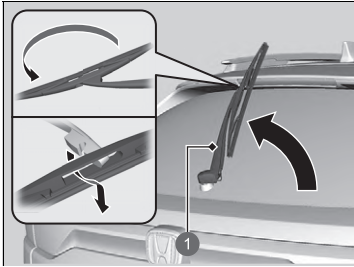

1 Wiper Arm

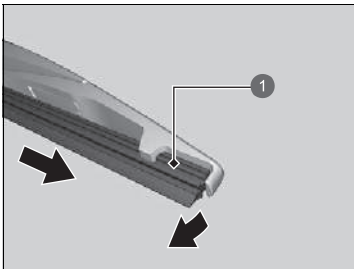

1 Wiper Blade

1. Raise the wiper arm off.
2. Pivot the bottom end of the wiper blade up until it comes off from the wiper arm.

3. Slide the blade out of the wiper.

Changing the Rear Wiper Blade Rubber

NOTICE

Avoid dropping the wiper arm; it may damage the rear window.

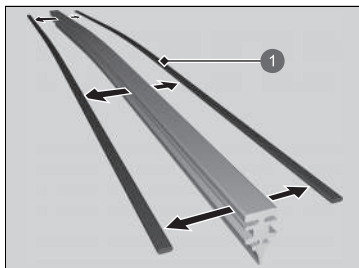

1 Retainer

4. Remove the retainers from wiper blade and mount to a new rubber blade.

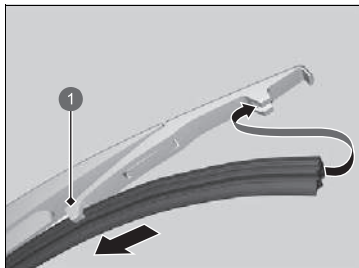

1 Holder

5. Slide the new wiper blade onto the holder.
► Make sure it is engaged correctly, then install the wiper blade assembly onto the wiper arm.

Checking Tyres

To safely operate your vehicle, your tyres must be of the proper type and size, in good condition with adequate tread, and properly inflated.

■ Inflation guidelines

Properly inflated tyres provide the best combination of handling, tread life, and comfort. Refer to the driver's doorjamb label for the specified pressure.

Underinflated tyres wear unevenly, adversely affect handling and fuel economy, and are more likely to fail from overheating.

Overinflated tyres make your vehicle ride harshly, are more prone to road hazards, and wear unevenly.

Every day before you drive, look at each of the tyres. If one looks lower than the others, check the pressure with a tyre gauge.

At least once a month or before long trips, use a gauge to measure the pressure in all tyres. Even tyres in good condition can lose 10–20 kPa (0.1–0.2 bar, 1–2 psi) per month.

■ Inspection guidelines

Every time you check inflation, also examine the tyres and valve stems.

Look for:

- Bumps or bulges on the side or in the tread. Replace the tyre if you find any cuts, splits, or cracks in the side of the tyre. Replace it if you see fabric or cord.
- Remove any foreign objects and inspect for air leaks.
- Uneven tread wear. Have a dealer check the wheel alignment.
- Excessive tread wear.

➤ **Wear Indicators** P. 542

- Cracks or other damage around valve stem.

☒ Checking Tyres

⚠ WARNING

Using tyres that are excessively worn or improperly inflated can cause a crash in which you can be seriously hurt or killed.

Follow all instructions in this owner's manual regarding tyre inflation and maintenance.

Measure the air pressure when tyres are cold. This means the vehicle has been parked for at least three hours, or driven less than 1.6 km (1 mile). If necessary, add or release air until the specified pressure is reached.

If checked when hot, tyre pressure can be as much as 30–40 kPa (0.3–0.4 bar, 4–6 psi) higher than if checked when cold.

Whenever tyre pressure is adjusted, you must calibrate the deflation warning system.

➤ **Deflation Warning System** P. 392

Wear Indicators

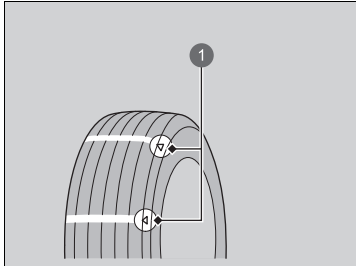

1 Example of a Wear Indicator mark

The groove where the wear indicator is located is about 1.6 mm (about 1/16 inch) shallower than elsewhere on the tyre. If the tread has worn so that the indicator is exposed, replace the tyre.

Worn out tyres have poor traction on wet roads.

☒ Checking Tyres

Have a dealer check the tyres if you feel a consistent vibration while driving. New tyres and any that have been removed and reinstalled should be properly balanced.

Tyre Service Life

The life of your tyres is dependent on many factors, including driving habits, road conditions, vehicle loading, inflation pressure, maintenance history, speed, and environmental conditions (even when the tyres are not in use).

In addition to regular inspections and inflation pressure maintenance, it is recommended that you have annual inspections performed once the tyres reach five years old. All tyres should be removed from service after 10 years from the date of manufacture, regardless of their condition or state of wear.

Tyre and Wheel Replacement

Replace your tyres with radials of the same size, load range, speed rating, and maximum cold tyre pressure rating (as shown on the tyre's sidewall). Using tyres of a different size or construction can cause certain vehicle systems such as the ABS and Vehicle Stability Assist (VSA) system to work incorrectly.

It is best to replace all four tyres at the same time. If that isn't possible, replace the front or rear tyres in pairs.

Make sure that the wheel's specifications match those of the original wheels.

▶▶ Tyre and Wheel Replacement

WARNING

Installing improper tyres on your vehicle can affect handling and stability. This can cause a crash in which you can be seriously hurt or killed.

Always use the size and type of tyres recommended in the tyre information label on your vehicle.

Tyre Rotation

Rotating tyres according to the maintenance schedule helps to distribute wear more evenly and increase tyre life.

■ Tyres without rotation marks

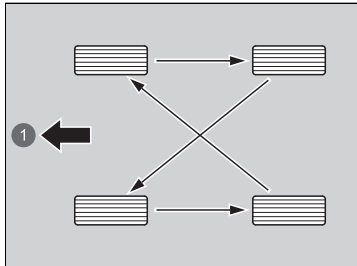

① Front

Rotate the tyres as shown here.

■ Tyres with rotation marks

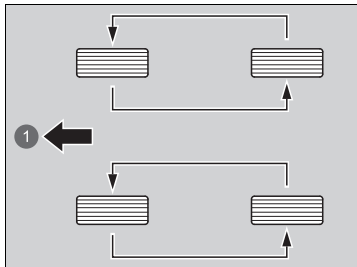

① Front

Rotate the tyres as shown here.

► Tyre Rotation

Tyres with directional tread patterns should only be rotated front to back (not from one side to the other). Directional tyres should be mounted with the rotation indication mark facing forward, as shown below.

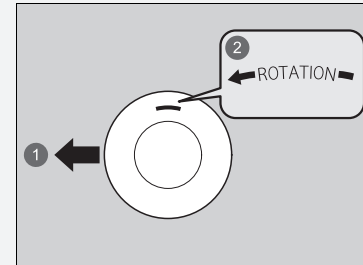

① Front

② Rotation Mark

When the tyres are rotated, make sure the air pressures are checked.

Whenever tyres are rotated, you must calibrate the deflation warning system.

► **Deflation Warning System** P. 392

Snow Traction Devices

If driving on snowy or frozen roads, mount winter tyres, or tyre chains; reduce speed; and maintain sufficient distance between vehicles when driving.

Be particularly careful when operating the steering wheel or brakes to prevent skidding.

Use tyre chains, winter tyres, or all season tyres when necessary or according to the law.

When mounting, refer to the following points.

For winter tyres:

- Select the size and load ranges that are the same as the original tyres.
- Mount the tyres to all four wheels.

For tyre chains:

- Consult a dealer before purchasing any type of chains for your vehicle.
- Install them on the front tyres only.
- Because your vehicle has limited tyre clearance, we strongly recommend using the chains listed below:

Original Tyre Size*1	Chain Type
225/50R18	RUD innove8 HYBRID 4718376

*1: Original tyre size is mentioned on the tyre information label on the driver's doorjamb.

- Follow the chain manufacturer's instruction when installing. Mount them as tightly as you can.
- Check that the chains do not touch the brake lines or suspension.
- Drive slowly.

⚠ Snow Traction Devices

⚠ WARNING

Using the wrong chains, or not properly installing chains, can damage the brake lines and cause a crash in which you can be seriously injured or killed.

Follow all instructions in this owner's manual regarding the selection and use of tyre chains.

NOTICE

Traction devices that are the wrong size or improperly installed can damage your vehicle's brake lines, suspension, body, and wheels. Stop driving if they are hitting any part of the vehicle.

According to the EU legislation for tyres, when winter tyres are used, it is necessary to affix a sticker with the allowable max. speed of the winter tyres clearly in the field of view of the driver, if the designed max. speed of vehicle is higher than the allowed max. speed of winter tyre. A sticker is obtainable from your tyre dealer. If you have any question, consult a dealer.

When tyre chains are mounted, follow the chain manufacturer's instructions regarding vehicle operational limits.

Use tyre chains only in an emergency or when they are legally required for driving through a certain area.

Use greater caution when driving with tyre chains on snow or ice. They may have less-predictable handling than good winter tyres without chains.

If your vehicle is equipped with summer tyres, be aware that these tyres are not designed for winter driving conditions. For more information, contact a dealer.

Checking the 12-Volt Battery

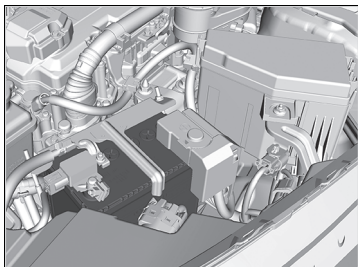

The condition of the battery is monitored by a sensor located on the negative terminal of the battery. If there is a problem with this sensor, the driver information interface will display a warning message. If this happens, have your vehicle inspected by a dealer.

Check the battery terminals for corrosion monthly.

If your vehicle's battery is disconnected or goes dead:

- The audio system is disabled.
 - **Reactivating the audio system** P. 247
- The clock resets.
 - **Clock** P. 150
 - **Clock Setup** P. 266

Right-hand Drive Type

- The immobilizer system needs to be reset.
 - **Immobilizer System Indicator** P. 113

12-Volt Battery

⚠ WARNING

The battery gives off explosive hydrogen gas during normal operation.

A spark or open flame can cause the battery to explode with enough force to kill or seriously hurt you.

Keep all sparks, open flames, and smoking materials away from the battery.

Wear protective clothing and a face shield, or have a skilled technician do any battery maintenance.

⚠ WARNING

The battery contains sulfuric acid (electrolyte) which is highly corrosive and poisonous.

Getting electrolyte in your eyes or on your skin can cause serious burns. Wear protective clothing and eye protection when working on or near the battery.

Swallowing electrolyte can cause fatal poisoning if immediate action is not taken.

KEEP OUT OF THE REACH OF CHILDREN

⌘ 12-Volt Battery

Emergency Procedures

Eyes: Flush with water from a cup or other container for at least 15 minutes. (Water under pressure can damage the eye.) Call a physician immediately.

Skin: Remove contaminated clothing. Flush the skin with large quantities of water. Call a physician immediately.

Swallowing: Drink water or milk. Call a physician immediately.

When you find corrosion, clean the battery terminals by applying a baking powder and water solution.

Clean the terminals with a damp towel. Cloth/towel dry the battery. Coat the terminals with grease to help prevent future corrosion.

When replacing the battery, the replacement must be of the same specifications.

Consult a dealer for more information.

Charging the 12-Volt Battery

Disconnect both battery cables to prevent damaging your vehicle's electrical system. Always disconnect the negative (–) cable first, and reconnect it last.

⌘ 12-Volt Battery

The indicators for the Adaptive Cruise Control (ACC) with Low Speed Follow, Vehicle Stability Assist (VSA) system, Vehicle Stability Assist (VSA) OFF, Safety Support (Amber), and Low Tyre Pressure/Deflation Warning System may come on along with a message in the driver information interface when you set the power mode to ON after reconnecting the 12-volt battery.

Drive a short distance at more than 20 km/h (12 mph). The indicator should go off. If it does not, have your vehicle checked by a dealer.

Replacing the 12-Volt Battery

When you remove and replace the 12-volt battery, always follow the maintenance safety and the warnings for when checking the battery to prevent potential hazards.

🔧 **Maintenance Safety** P. 501

🔧 **Checking the 12-Volt Battery** P. 546

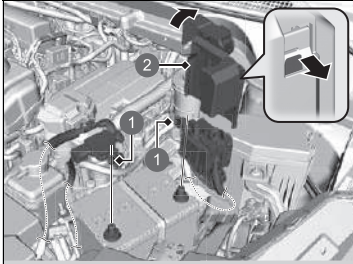

- 1 Nut
- 2 Cover

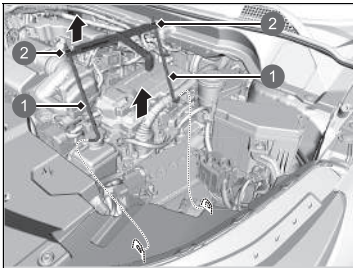

- 1 Stay
- 2 Nut

1. Set the power mode to VEHICLE OFF. Open the bonnet.
2. Loosen the nut on the negative battery cable, then disconnect the cable from the negative (-) terminal.
3. Open the positive battery terminal cover. Loosen the nut on the positive battery cable, then disconnect the cable from the positive (+) terminal.
4. Loosen the nut on each side of the battery bracket with a wrench.
5. Pull the bottom end of each battery stay out of the hole on the battery base, and remove the combination of the battery bracket and the stays.

Repeating the 12-Volt Battery

NOTICE

An improperly disposed of battery can be harmful to the environment and human health. Always confirm local regulations for battery disposal.

This symbol on the battery means that this product must not be treated as household waste.



To install a new battery, reverse this procedure.

Always disconnect the negative (-) cable first, and reconnect it last.

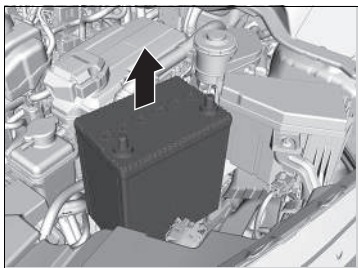

6. Take out the battery carefully.

Battery Label



▶▶ Battery Label

DANGER

- Keep flames and sparks away from the battery. The battery produces explosive gas that can cause an explosion.
- Wear eye protection and rubber gloves when handling the battery to avoid risk of burns or loss of eyesight if exposed to battery electrolyte.
- Do not allow children to handle the battery, under any circumstance. Ensure that anyone handling the battery has a proper understanding of the hazards and correct handling procedures involved.
- Handle battery electrolyte with extreme care, as it contains dilute sulfuric acid. Exposure to eyes or skin can cause burns or loss of eyesight.
- Read this manual carefully, and understand it before handling the battery. Failure to do so can cause personal injury and damage to the vehicle.
- Do not use the battery if the level of electrolyte is at or below the recommended level. Using the battery with low electrolyte can cause it to explode, causing serious injury.

Replacing the Remote Battery

If the indicator does not come on when the button is pressed, replace the battery.

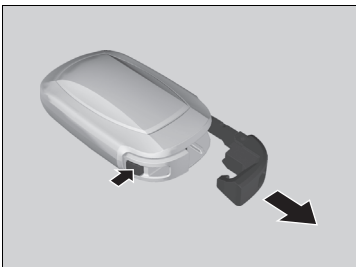

Battery type: CR2032

1. Remove the built-in key.



2. Remove the upper half of the cover by carefully prying on the slot with key grip.
- ▶ Wrap the key grip with a cloth to prevent scratching the remote key.
 - ▶ Remove carefully to avoid losing the buttons.

Replacing the Remote Battery

⚠ ⚠ WARNING

CHEMICAL BURN HAZARD

The battery that powers the remote transmitter can cause severe internal burns and can even lead to death if swallowed. Keep new and used batteries away from children.

If you suspect that a child has swallowed the battery, seek medical attention immediately.

CAUTION: Danger of explosion if battery is incorrectly replaced. Replace only with the same or equivalent type.

CAUTION: Do not exposed to excessive heat such as sunshine, fire or the like, that can result in an explosion or the leakage of flammable liquid or gas during use, storage or transportation.

CAUTION: Do not dispose of a battery into fire or a hot oven, or give mechanically crushing or cutting of a battery, that can result in an explosion.

CAUTION: Do not subjected to extremely low air pressure at high altitude that may result in an explosion or the leakage of flammable liquid or gas.

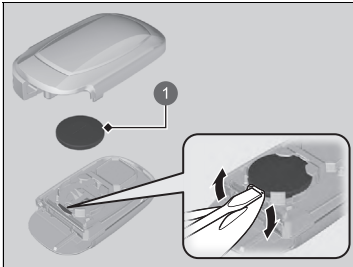

1 Battery

3. Remove the battery by prying on the edge with flat-tip screwdriver. Make sure to replace the battery with the correct polarity.
 - ▶ Wrap a flat-tip screwdriver with a cloth to prevent scratching the remote key.

▶▶ Replacing the Remote Battery

A warning mark is located adjacent to the button battery*.

NOTICE

An improperly disposed of battery can damage the environment. Always confirm local regulations for battery disposal.

This symbol on the battery means that this product must not be treated as household waste.



Replacement batteries are commercially available or at a dealer.

* Not available on all models

Air Conditioning

For proper and safe operation of the climate control system, the refrigerant system should only be served by a qualified technician.

Never repair or replace the air conditioning evaporator (cooling coil) with one removed from a used or salvaged vehicle.

Climate Control System Maintenance

NOTICE

Vented refrigerant is harmful to the environment. To avoid refrigerant from venting, never replace the evaporator with one removed from a used or salvaged vehicle.

Refrigerant in your vehicle's air conditioning system is flammable and can be ignited during servicing if proper procedures are not followed.

The air conditioner label is found under the bonnet:

➤ **Safety Labels** P. 99

➤ **Specifications** P. 610



 : Caution

 : Flammable Refrigerant

 : Requires a qualified technician to service

 : Air Conditioning System

Dust and Pollen Filter

■ When to Replace the Dust and Pollen Filter

Replace the dust and pollen filter according to your vehicle's recommended maintenance schedule. It is recommended to replace the filter even sooner if the vehicle has been driven in a dusty environment.

📄 **Maintenance Schedule*** P. 509

■ How to Replace the Dust and Pollen Filter

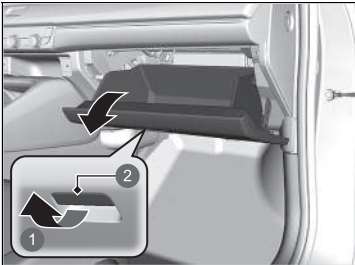

1. Open the glove box.

- ① Pull
- ② Handle

📄 Dust and Pollen Filter

If the airflow from the climate control system deteriorates noticeably, and the windows fog up easily, the filter may need to be replaced.

The dust and pollen filter collects pollen, dust, and other debris in the air.

If you are not sure how to replace the dust and pollen filter, have it replaced by a dealer.

* Not available on all models

Continued

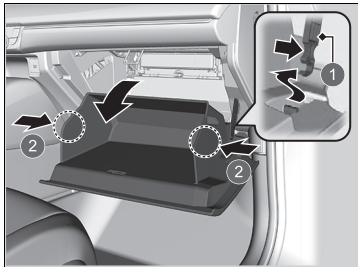

2. Push the stopper on the passenger's side of the glove box to detach it from glove box.
3. Disengage the two tabs by pushing on each side panel.
4. Pivot the glove box out of the way.

- 1 Stopper
- 2 Tabs

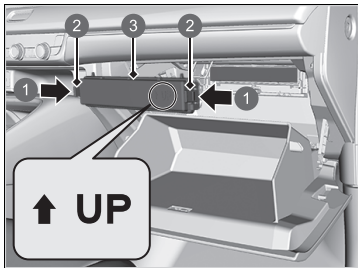

5. Push in the tabs on the corners of the filter case cover, and remove it.

- 1 Push
- 2 Tabs
- 3 Cover

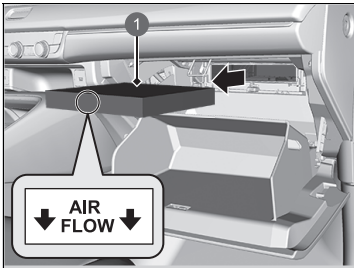

1 Dust and Pollen Filter

6. Remove the filter from the case.
7. Install a new filter in the case.
 - Put the **AIR FLOW** arrow directed side down.

Interior Care

Use a vacuum cleaner to remove dust before using a cloth.

Use a damp cloth with a mixture of mild detergent and warm water to remove dirt.

Use a clean cloth to remove detergent residue.

Cleaning Seat Belts

Use a soft brush with a mixture of mild soap and warm water to clean the seat belts.

Let the belts air dry. Wipe the loops of the seat belt anchorages using a clean cloth.



1 Loop

Interior Care

Do not spill liquids inside the vehicle. Electrical devices and systems may malfunction if liquids are splashed on them.

Do not use silicone based sprays on electrical devices such as audio devices and switches. Doing so may cause the items to malfunction or cause a fire inside the vehicle.

If a silicone based spray is inadvertently used on electrical devices, consult a dealer.

Depending on their composition, chemicals and liquid aromatics may cause discolouration, wrinkles, and cracking to resin-based parts and textiles. Do not use alkali solvents or organic solvents such as benzene or petrol.

After using chemicals, make sure to gently wipe them away using a dry cloth.

Do not place used cloths on top of resin based parts or textiles for long periods of time without washing.

Be careful not to spill a liquid type air freshener.

■ Cleaning the Window

Wipe using a glass cleaner.

■ Super UV Cut/IR Cut Glass

The front side windows are laminated with UV- and/or IR-cut film. When cleaning the interior side of the windows, make sure to use a soft damp cloth.

■ Floor Mats (Optional)

The driver's and front passenger's floor mats hook over the floor anchors, which keep the mats from sliding forward. When reinstalling the mats after cleaning, position them properly.

Do not put additional floor mats on top of the anchored mats.

■ Maintaining Genuine Leather*

To properly clean leather:

1. Use a vacuum or soft dry cloth first to remove any dirt or dust.
2. Clean the leather with a soft cloth dampened with a solution comprised of 90% water and 10% neutral soap.
3. Wipe away any soap residue with a clean damp cloth.
4. Wipe away residual water and allow leather to air dry in the shade.

* Not available on all models

☒ Cleaning the Window

Wires are mounted to the inside of the rear window. Wipe along the same direction as the wires with a soft cloth so as not to damage them.

Be careful not to spill fluids, such as water or glass cleaner, on or around the cover of both the front wide view camera and the rainfall/light sensor.

To ensure the longevity of the UV- and/or IR-cut film, avoid:

- Opening and closing the windows when they are covered with dirt and other debris.
- Using a glass cleaner containing polishing compounds, wax, or detergents.

☒ Floor Mats (Optional)

If you use any floor mats that were not originally provided with your vehicle, make sure they are designed for your specific vehicle, fit correctly, and are securely anchored by the floor anchors. Position the rear seat floor mats properly. If not properly positioned, the floor mats can interfere with the front seat functions.

☒ Maintaining Genuine Leather*

It is important to clean or wipe away dirt or dust as soon as possible. Spills can soak into leather resulting in stains. Dirt or dust can cause abrasions in the leather. In addition, please note that some dark coloured clothing can rub onto the leather seats resulting in discolouration or stains.

Exterior Care

Dust off the vehicle body after you drive. Regularly inspect your vehicle for scratches on painted surfaces. A scratch on a painted surface can result in body rust. If you find a scratch, promptly repair it.

■ Washing the Vehicle

Wash the vehicle regularly. Wash more frequently when driving in the following conditions:

- If driving on roads with road salt.
- If driving in coastal areas.
- If tar, soot, bird droppings, insects, or tree sap are stuck to painted surfaces.

■ Using an Automated Car Wash

- Make sure to follow the instructions indicated on the automated car wash.
- Fold in the door mirrors.
- For models equipped with automatic intermittent wipers, turn the wipers off.

■ Using High Pressure Cleaners

- Keep sufficient distance between the cleaning nozzle and the vehicle body.
- Take particular care around the windows. Standing too close may cause water to enter the vehicle interior.
- Do not spray high pressure water directly into the engine compartment. Instead, use low pressure water and a mild detergent.

▣ Washing the Vehicle

Do not spray water into the air intake vents. It can cause a malfunction.

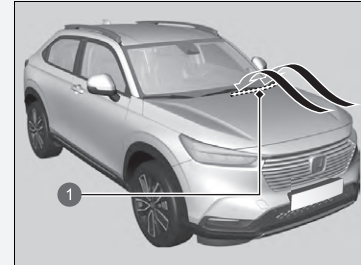

① Air Intake Vents

■ Applying Wax

A good coat of automotive body wax helps to protect your vehicle's paint from the elements. Wax will wear off over time and expose your vehicle's paint to the elements, so reapply as necessary.

■ Maintaining the Bumpers and Other Resin Coated Parts

If you get petrol, oil, engine coolant, or battery fluid on resin coated parts, they may be stained or the coating may peel. Promptly wipe it away using a soft cloth and clean water.

■ Cleaning the Window

Wipe using a glass cleaner.

■ Water repellent glass*

The front side windows are fitted with water repellent agent glasses that disperse water into droplets. To clean the front side windows, wash off with water, or wipe with a soft damp cloth.

Using a glass cleaner may temporarily prevent the water repellent glasses from dispersing water. Rinsing the glasses with water can make them water repellent again. If you find that the glass has stopped dispersing water, consult a dealer.

* Not available on all models

Continued

☒ Applying Wax

NOTICE

Chemical solvents and strong cleaners can damage the paint, metal, and plastic on your vehicle. Wipe away spills immediately.

☒ Maintaining the Bumpers and Other Resin Coated Parts

Ask a dealer about the correct coating material when you want to repair the painted surface of the parts made of resin.

☒ Cleaning the Window

Models with water repellent glass

To make the water-repellent effect last longer, do the following:

- Avoid opening and closing the front side windows when the windows are covered with dirt.
- Avoid using a glass cleaner with polishing compounds, wax, or detergent.
- Avoid scraping off frosts on the windows using a metallic tool.
- Dirt off the windows before using an automated car wash.

■ Maintaining Aluminium Wheels

Aluminium is susceptible to deterioration caused by salt and other road contaminants. When necessary, as early as possible use a sponge and mild detergent to wipe away these contaminants. Do not use a stiff brush or harsh chemicals (including some commercial wheel cleaners). These can damage the protective finish on aluminium alloy wheels, resulting in corrosion. Depending on the type of finish, the wheels also may lose their lustre or appear burnished. To avoid water stains, wipe the wheels dry with a cloth while they are still wet.

■ Fogged Exterior Light Lenses

The inside lenses of exterior lights (headlights, brake lights, etc.) may fog temporarily if you have driven in the rain, or after the vehicle has been run through a car wash. Dew condensation also may build up inside the lenses when there is a significant enough difference between the ambient and inside lens temperatures (similar to vehicle windows fogging up in rainy conditions). These conditions are natural processes, not structural design problems in the exterior lights.

Lens design characteristics may result in moisture developing on the light lens frame surfaces. This also is not a malfunction.

However, if you see large amounts of water accumulation, or large water drops building up inside the lenses, have your vehicle inspected by a dealer.

Hydrophilic Mirror*

Your vehicle's door mirror surface is coated with hydrophilic film. Follow the next steps when the mirrors become less hydrophilic.

1. Rinse the door mirrors with water and remove dirt.
2. Wipe the mirrors with a clean damp cloth.
 - ▶ If you cannot remove dirt, use the genuine window cleaner, or neutral household detergent, and rinse with enough water.
3. Expose the mirrors to the sun for five to nine hours.

Painting the Vehicle

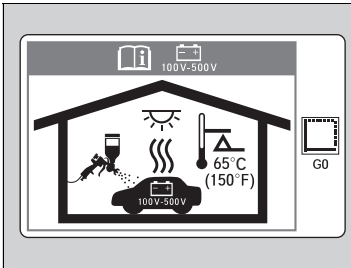

High temperature may damage the high-voltage battery used to power the electric motor.

When painting the vehicle in a heated paint booth, make sure the temperature does not exceed 65°C.

Hydrophilic Mirror*

NOTICE

To keep the hydrophilicity of the mirrors,

- Do not apply wax or water repellent agent on the mirror surface.
- Do not wipe the mirrors with a gritty cloth or abrasive cleanser.

* Not available on all models

Accessories

When installing accessories, check the following:

- Do not install accessories on the windshield. They can obstruct your view and delay your reaction to driving conditions.
- Do not install any accessories over areas marked SRS Airbag, on the sides or backs of the front seats, on front or side pillars, or near the side windows. Accessories installed in these areas may interfere with proper operation of the vehicle's airbags or may be propelled into you or another occupant if the airbags deploy.
- Be sure electronic accessories do not overload electrical circuits or interfere with proper operation of your vehicle.
 - **Fuses** P. 600
- Before installing any electronic accessory, have the installer contact a dealer for assistance. If possible, have a dealer inspect the final installation.

Accessories and Modifications

WARNING

Improper accessories or modifications can affect your vehicle's handling, stability, and performance, and cause a crash in which you can be seriously hurt or killed.

Follow all instructions in this owner's manual regarding accessories and modifications.

WARNING

Use of improperly designed, engineered or manufactured high-voltage battery assemblies could cause a fire in your vehicle.

A vehicle fire could result in a crash or injury.

Only use a genuine Honda high-voltage battery assembly, or its equivalent, in your vehicle.

Modifications

Do not modify your vehicle in a manner that may affect its handling, stability, or reliability, or install non-genuine Honda parts or accessories that may have a similar effect.

Even minor modifications to vehicle systems can affect overall vehicle performance. Always make sure all equipment is properly installed and maintained, and do not make any modification to your vehicle or its systems that might cause your vehicle to no longer meet your country's and local regulations.

The on-board diagnostic port (OBD-II/SAE J1962 connector) installed on this vehicle is intended to be used with automobile system diagnostic devices or with other devices that Honda has approved. Use of any other type of device may adversely affect the vehicle's electronic systems or allow them to be compromised, possibly resulting in a system malfunction, drained battery, or other unexpected problems.

Do not modify or attempt to repair your vehicle's high-voltage hybrid power system or otherwise modify vehicle electrical systems. Disassembling or modifying electrical equipment can result in a crash or a fire.

If you ever need to replace your vehicle's high-voltage battery assembly outside of warranty coverage, we highly recommend that you only use a genuine Honda high-voltage battery assembly. Genuine Honda high-voltage battery assemblies are designed to work with your vehicle's hybrid power system and have been designed, engineered and manufactured to avoid overcharging situations. Non-genuine high-voltage battery assemblies may not have been similarly designed, engineered and manufactured, and installation of such assemblies could result in overcharging, fires, loss of power, or other conditions that may increase the likelihood of a crash or injury.

Accessories and Modifications

When properly installed, mobile phones, alarms, two-way radios, radio antennas, and low-powered audio systems should not interfere with your vehicle's computer controlled systems, such as your airbags and anti-lock brakes.

Honda Genuine accessories are recommended to ensure proper operation on your vehicle.

Handling the Unexpected

This chapter explains how to handle unexpected troubles.

Tools

Types of Tools..... 568

If a Tyre Goes Flat

Temporarily Repairing a Flat Tyre..... 569

Handling of the Jack..... 582

Power System Won't Start

Checking the Procedure..... 583

If the Keyless Remote Battery is Weak .. 584

Emergency Power System On..... 585

Emergency Power System Off..... 586

If the 12-Volt Battery Is Dead 587

Shift Lever Does Not Move..... 590

Overheating

How to Handle Overheating..... 591

Indicator, Coming On/Blinking

If the Engine Oil Pressure Low Warning Appears .. 593

If the 12-Volt Battery Charging System Indicator Comes On 593

If the Reduced Stopping Power Warning Appears 594

If the Malfunction Indicator Lamp Comes On or Blinks 594

If the Brake System Indicator (Red) Comes On or Blinks 595

If the Electric Power Steering (EPS) System Indicator Comes On 596

If the Brake System Indicator (Red) Comes On or Blinks at the Same Time When the Brake System Indicator (Amber) Comes On .. 597

If the Low Tyre Pressure/Deflation Warning System Indicator Comes On or Blinks.. 598

If the Engine Oil Level Low Warning Appears... 599

Fuses

Fuse Locations 600

Inspecting and Changing Fuses..... 605

Emergency Towing..... 606

If You Cannot Open the Tailgate 607

Types of Tools

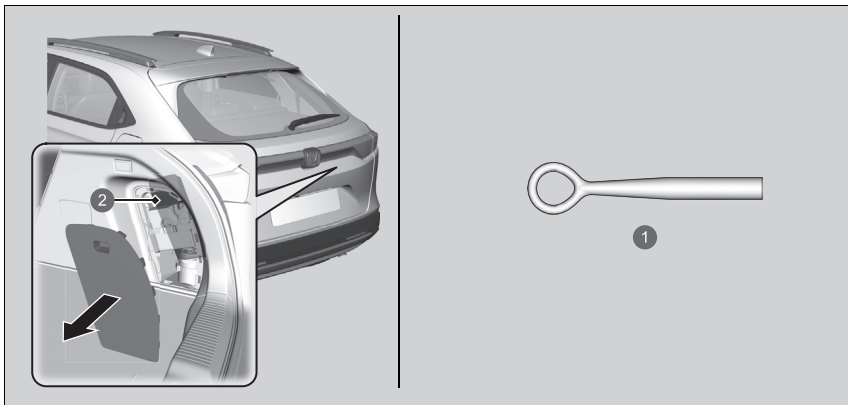

- ① Detachable Towing Hook
- ② Tool Bag

Types of Tools

The tools are stored in the luggage area.

Temporarily Repairing a Flat Tyre

If the tyre has a large cut or is otherwise severely damaged, you will need to have the vehicle towed. If the tyre only has a small puncture, from a nail for instance, you can use the temporary tyre repair kit so that you can drive to the nearest service station for a more permanent repair.

If a tyre goes flat while driving, grasp the steering wheel firmly, and brake gradually to reduce speed. Then, stop in a safe place.

1. Park the vehicle on a firm, level, non-slippery ground and apply the parking brake.
2. Put the transmission into **P**.
3. Turn on the hazard warning lights and set the power mode to VEHICLE OFF (LOCK).

Temporarily Repairing a Flat Tyre

The kit should not be used in the following situations. Instead, contact a dealer or a roadside assistant to have the vehicle towed.

- The tyre sealant has expired.
- More than one tyre is punctured.
- The puncture or cut is larger than 4 mm (3/16 inch).
- The tyre side wall is damaged or the puncture is outside the contact area.

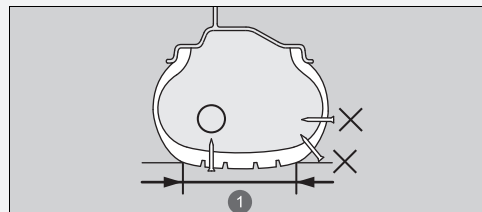

When the puncture is:	Kit Use
Smaller than 4 mm (3/16 inch)	Yes
Larger than 4 mm (3/16 inch)	No

1 Contact Area

- Damage has been caused by driving with the tyres extremely under inflated.
- The tyre bead is no longer seated.
- The rim is damaged.

Do not remove a nail or screw that punctured the tyre. If you remove it from the tyre, you may not be able to repair the puncture using the kit.

■ Getting Ready to Temporarily Repair the Flat Tyre

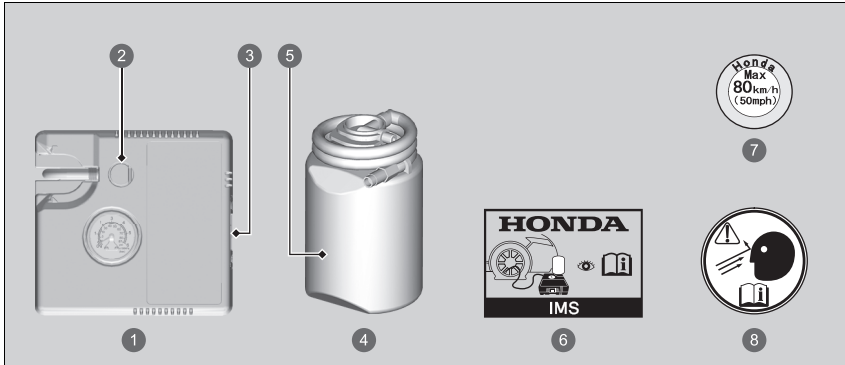

- ① Air Compressor
- ② Deflate Button
- ③ Air Compressor Switch
- ④ Sealant Bottle
- ⑤ Expiration Date
- ⑥ Instruction Manual
- ⑦ Speed Restriction Label
- ⑧ Wheel Label

▶▶ Getting Ready to Temporarily Repair the Flat Tyre

When making a temporary repair, carefully read the instruction manual provided with the kit.

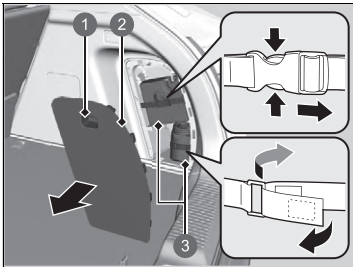

- ❶ Tab
- ❷ Cover
- ❸ Tyre Repair Kit

1. Open the tailgate.
2. Pull the tab to open the compartment cover located on the right side of the luggage area.
3. Take the kit out of the compartment.
4. Place the kit face up, on flat ground near the flat tyre, and away from traffic. Do not place the kit on its side.

■ Injecting Sealant and Air

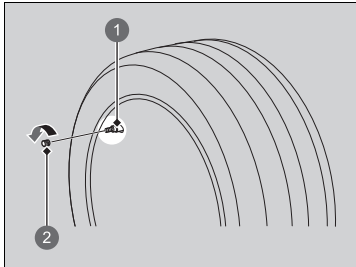

- ① Tyre Valve Stem
- ② Valve Cap

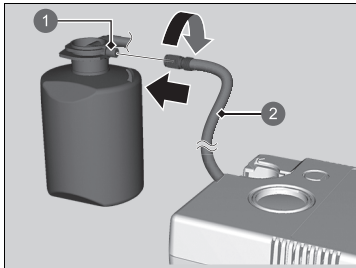

- ① Bottle Tyre Valve
- ② Air Compressor Hose

1. Remove the valve cap from the tyre valve stem.

- 2. Shake the sealant bottle.
- 3. Attach the air compressor hose onto the bottle tyre valve. Screw it until it is tight.

▶▶ Injecting Sealant and Air

⚠ WARNING

Tyre sealant contains substances that are harmful and can be fatal if swallowed.

If accidentally swallowed, do not induce vomiting. Drink plenty of water and get medical attention immediately.

For skin or eye contact, flush with cool water and get medical attention if necessary.

Keep the sealant bottle out of the reach of children.

In cold temperatures, the sealant may not flow easily. In this situation, warm it up for five minutes before using.

The sealant is latex based and can permanently stain clothing and other materials. Be careful during handling and wipe up any spills immediately.

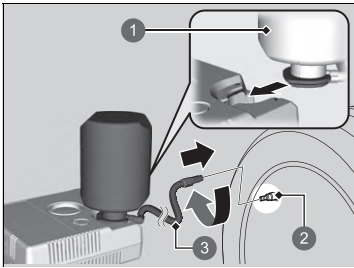

- ❶ Sealant Bottle
- ❷ Tyre Valve Stem
- ❸ Sealant/Air Hose

- 4. Upside down the sealant bottle, then attach the bottle into the cutout of the air compressor.
- 5. Attach the sealant/air hose onto the tyre valve stem. Screw it until it is tight.

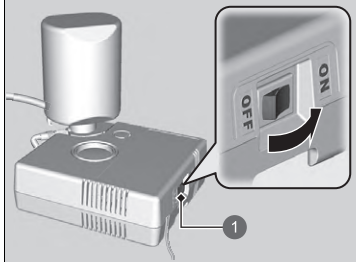
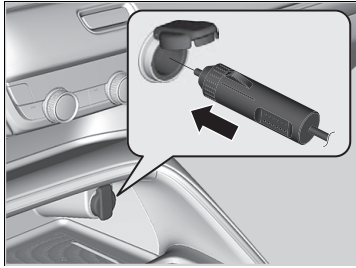

1 Air Compressor Switch

6. Plug in the compressor to the accessory power socket.
 - ▶ Be careful not to pinch the cord in a door or window.
 - **Accessory Power Socket** P. 230
7. Turn on the vehicle's power system.
 - **Carbon Monoxide Gas** P. 98
8. Turn the air compressor on to inflate the tyre.
 - ▶ The compressor starts injecting sealant and air into the tyre.
9. After the air pressure reaches to specified pressure, turn off the kit.
 - ▶ Check the air pressure gauge on the air compressor.
 - ▶ Refer to the driver's doorjamb label for the specified pressure.

▶▶ Injecting Sealant and Air

⚠ WARNING

Running the engine with the vehicle in an enclosed or even partly enclosed area can cause a rapid buildup of toxic carbon monoxide.

Breathing this colourless, odourless gas can cause unconsciousness and even death. Only run the engine to power the air compressor with the vehicle outdoors.

NOTICE

Do not operate the temporary tyre repair kit compressor for more than 15 minutes. The compressor can overheat and become permanently damaged.

Until the sealant injection is complete, the pressure shown on the pressure gauge will appear higher than actual. After the sealant injection is complete the pressure will drop and then begin to rise again as the tyre is inflated with air. This is normal. To accurately measure the air pressure using the gauge, turn the air compressor off only after the sealant injection is complete.

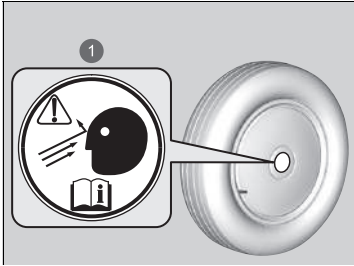

① Wheel Label

10. Unplug the power plug from the accessory power socket.
11. Unscrew the sealant/air hose from the tyre valve stem. Reinstall the valve cap.
12. Detach the bottle from the air compressor.
13. Press the deflate button until the gauge returns to 0 kPa (0 bar, 0 psi).
14. Apply the wheel label to the flat surface of the wheel.
 - ▶ The wheel surface must be clean to ensure the label adheres properly.
15. Store the tyre repair kit in the luggage area.

✘ Injecting Sealant and Air

If the required air pressure is not reached within 10 minutes, the tyre may be too severely damaged for the kit to provide the necessary seal and your vehicle will need to be towed.

See a Honda dealer for a replacement sealant bottle and proper disposal of an empty bottle.

Inform the use of tyre sealant when you ask a Honda dealer or the road assistant service for replacing or repairing the flat tyre.

This air compressor is designed for the automotive tyre. Check the following:

- The power supply of the air compressor is limited to your vehicle's 12-volt DC accessory power socket.
- Do not operate the temporary tyre repair kit compressor for more than 15 minutes. The compressor can overheat and become permanently damaged.

Make it cool down when using the compressor continuously.

■ Distributing the Sealant in the Tyre

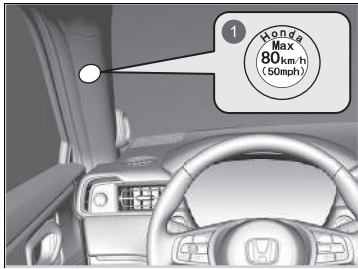

① Speed Restriction Label

1. Apply the speed restriction label to the location as shown.
2. Drive the vehicle for about 10 minutes.
 - ▶ Do not exceed 80 km/h (50 mph).
3. Stop the vehicle in a safe place.

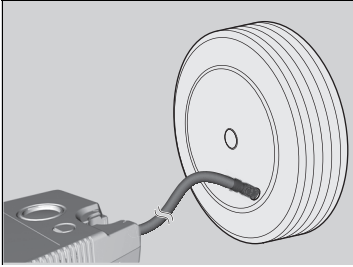

4. Recheck the air pressure using the gauge on the air compressor.
 - ▶ Do not turn the air compressor on to check the pressure.
 5. If the air pressure is:
 - Less than 130 kPa (1.3 bar, 19 psi):
Do not add air or continue driving. The leak is too severe. Call for help and have your vehicle towed.
 - ✘ **Emergency Towing** P. 606
 - Front:220 kPa (2.2 bar, 32 psi)/rear:210 kPa (2.1 bar, 30 psi) or more:
Continue driving for another 10 minutes or until you reach the nearest service station. Do not exceed 80 km/h (50 mph).
- ▶ If the air pressure does not go down after the 10 minute driving, you do not need to check the pressure any more.

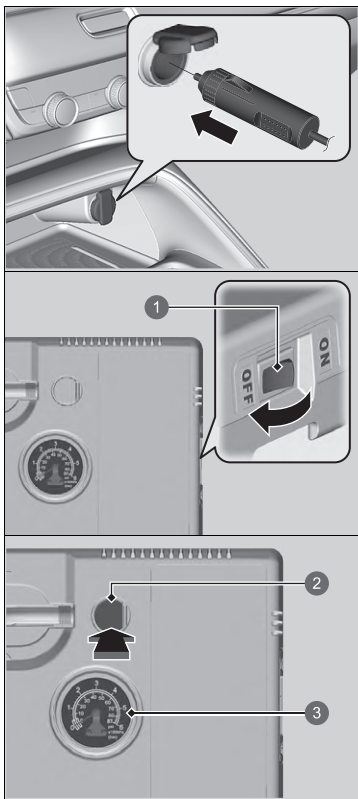

- 1 Air Compressor Switch
- 2 Deflate Button
- 3 Air Pressure Gauge

- Greater than 130 kPa (1.3 bar, 19 psi), but less than front:220 kPa (2.2 bar,32 psi)/rear:210 kPa (2.1 bar, 30 psi): Turn the air compressor on to inflate the tyre until the tyre pressure reaches front:220 kPa (2.2 bar, 32 psi)/rear:210 kPa (2.1 bar, 30 psi).

➤ **Injecting Sealant and Air** P. 572

Then, drive carefully for 10 more minutes or until you reach the nearest service station.

Do not exceed 80 km/h (50 mph).

- ▶ You should repeat this procedure as long as the air pressure is within this range.

6. Unplug the kit from the accessory power socket.
7. Unscrew the sealant/air hose from the tyre valve stem. Reinstall the valve cap.
8. Press the deflate button until the gauge returns to 0 kPa (0 bar, 0 psi).
9. Repackage and properly stow the kit.

▶▶ Distributing the Sealant in the Tyre

⚠ WARNING

Running the engine with the vehicle in an enclosed or even partly enclosed area can cause a rapid buildup of toxic carbon monoxide.

Breathing this colourless, odourless gas can cause unconsciousness and even death. Only run the engine to power the air compressor with the vehicle outdoors.

■ Inflating an Under-inflated Tyre

You can use the kit to inflate a non-punctured under-inflated tyre.

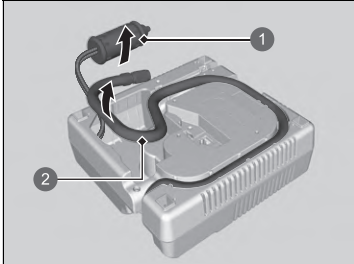

- ① Power Plug
- ② Air Hose

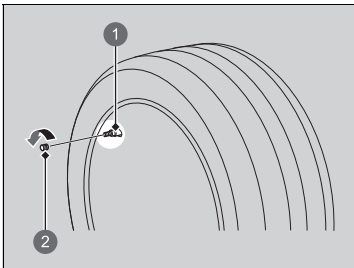

- ① Tyre Valve Stem
- ② Valve Cap

1. Take the kit out of the luggage area.
 - ▶ **Getting Ready to Temporarily Repair the Flat Tyre** P. 570
2. Place the kit, face up, on flat ground near the tyre to be inflated, away from traffic. Do not place the kit on its side.
3. Remove the air hose from the kit.
4. Remove the valve cap from the tyre valve stem.

▶▶ Inflating an Under-inflated Tyre

⚠ WARNING

Running the engine with the vehicle in an enclosed or even partly enclosed area can cause a rapid buildup of toxic carbon monoxide.

Breathing this colourless, odourless gas can cause unconsciousness and even death. Only run the engine to power the air compressor with the vehicle outdoors.

NOTICE

Do not operate the temporary tyre repair kit compressor for more than 15 minutes. The compressor can overheat and become permanently damaged.

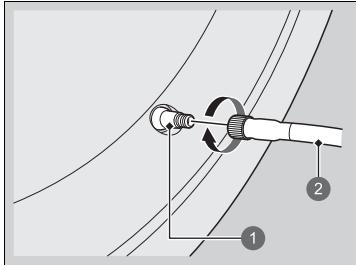

- ① Tyre Valve Stem
- ② Air Hose

5. Attach the air hose onto the tyre valve stem. Screw it until it is tight.

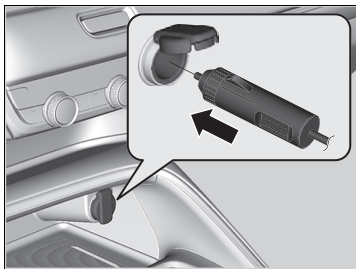

6. Plug in the compressor to the accessory power socket.

► Be careful not to pinch the cord in a door or window.

➤ **Accessory Power Socket** P. 230

7. Turn on the vehicle's power system.

➤ **Carbon Monoxide Gas** P. 98

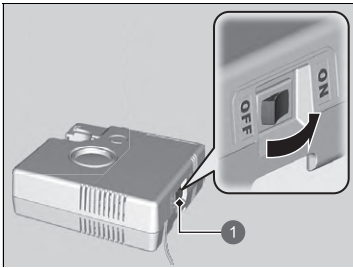

1 Air Compressor Switch

8. Turn the air compressor switch on to inflate the tyre.
 - ▶ The compressor starts to inject air into the tyre.
 - ▶ If you have started the engine, leave it running while injecting air.
9. Inflate the tyre to the specified air pressure.
10. Turn off the kit.
 - ▶ Check the pressure gauge on the air compressor.
 - ▶ If overinflated, press the deflate button.
11. Unplug the power plug from the accessory power socket.
12. Unscrew the air hose from the tyre valve stem. Reinstall the valve cap.
13. Repackage and properly stow the kit.

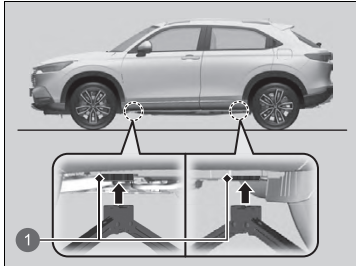

Handling of the Jack

Your vehicle has jacking points as shown.
When replacing your tyres, consult a dealer.



① Jacking Points



Checking the Procedure

When the  (Ready) indicator does not come on and  **Ready To Drive** does not appear on the driver information interface, check the following items and take appropriate action.

☒ Checking the Procedure



If you must start the vehicle immediately, use an assisting vehicle or booster battery to jump start it.

☒ **If the 12-Volt Battery Is Dead** P. 587

Checklist	Condition	What to Do
Check if the related indicator or driver information interface messages come on.	 Temperature Too Low For Vehicle To Operate appears.	<ul style="list-style-type: none"> You must wait for an increase in the ambient temperature or move the vehicle to a warmer location. Contact a dealer if necessary.
	 To Start, Hold Remote Near Start Button appears.	☒ If the Keyless Remote Battery is Weak P. 584
	The  (Power System) indicator comes on.	Have your vehicle checked by a dealer.
Check the brightness of the interior lights.	The interior lights are dim or do not come on at all.	Have the 12-volt battery checked by a dealer.
	The interior lights come on normally.	Check all fuses, or have your vehicle checked by a dealer. <ul style="list-style-type: none"> ☒ Inspecting and Changing Fuses P. 605 ☒ Emergency Power System On P. 585
Check the shift position.	The transmission is not in P .	Put the transmission into P .
Check the power system starting procedure.		☒ Turning on the Power P. 359
Follow the instructions, and try to start the power system again.		
Check the immobilizer system indicator.	When the immobilizer system indicator is blinking, the power system cannot be turned on.	☒ Immobilizer System Indicator P. 113

If you cannot turn on the power system after checking all the items in the list above, have your vehicle checked by a dealer.

If the Keyless Remote Battery is Weak

If the beeper sounds,  **To Start, Hold Remote Near Start Button** appears on the driver information interface, the **POWER** button flashes, and the  (Ready) indicator does not come on, turn on the power system as follows:

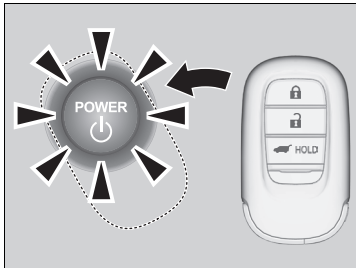

1. Touch the centre of the **POWER** button with the **H** logo on the keyless remote while the **POWER** button is flashing. The buttons on the keyless remote should be facing you.
 - ▶ The **POWER** button flashes for about 30 seconds.

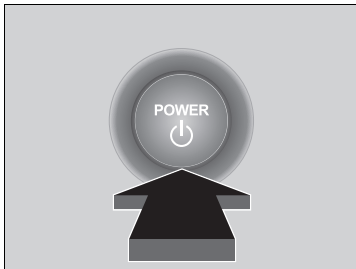

2. Depress the brake pedal and press the **POWER** button within 10 seconds after the beeper sounds and the **POWER** button changes from flashing to on.
 - ▶ If you do not depress the pedal, the mode will change to ACCESSORY.

Emergency Power System On

If the power system can not be turned on using the normal starting procedure, you may be able to turn it on using the emergency starting procedure below.

Do not use this procedure if it is not an emergency.

1. Make sure the parking brake is applied.
 - ▶ The parking brake and brake system indicator (red) comes on for 30 seconds when you press the electric parking brake switch.
2. Check that the transmission is in **[P]**, then set the power mode to ACCESSORY.
3. Firmly depress the brake pedal and press and hold the **POWER** button for at least 15 seconds.

This should be considered a system malfunction even if you are able to turn the power system on using the above procedure.

Have your vehicle checked by a dealer immediately.

⚠ Emergency Power System On

Refer to the following if you cannot move the shift lever out of the **[P]** position.

➡ **Shift Lever Does Not Move** P. 590

Emergency Power System Off

The **POWER** button may be used to turn the power system off due to an emergency situation even while driving. If you must turn the power system off, do either of the following operations:

- Press and hold the **POWER** button for about two seconds.
- Firmly press the **POWER** button three times.

The steering wheel will not lock. However, because turning off the power system disables the power assist the power system provides to the steering and braking systems, it will require significantly more physical effort and time to steer and slow the vehicle. Use both feet on the brake pedal to slow down the vehicle and stop immediately in a safe place.

The power mode is in ACCESSORY when the power system is stopped. To change the mode to VEHICLE OFF, put the transmission into **P** after the vehicle comes to a complete stop. Then, press the **POWER** button twice without depressing the brake pedal.

⌘ Emergency Power System Off

Do not press the **POWER** button while driving unless it is absolutely necessary for the power system to be turned off.

If you press the **POWER** button while driving, the beeper sounds.

If the 12-Volt Battery Is Dead

Jump Starting Procedure

Turn off the power to electric devices, such as audio and lights. Turn off the power system, then open the bonnet.

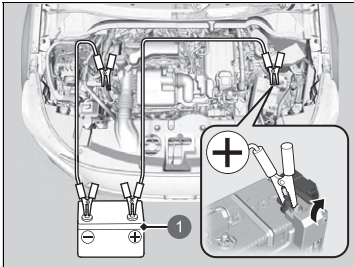

1 Booster Battery

1. Open the terminal cover on your vehicle's 12-volt battery positive \oplus terminal.
2. Connect the first jumper cable to your vehicle's 12-volt battery \oplus terminal.
3. Connect the other end of the first jumper cable to the booster battery \oplus terminal.
 - ▶ Use a 12-volt booster battery only.
 - ▶ When using an automotive battery charger to boost your 12-volt battery, select a lower charging voltage than 15-volt. Check the charger manual for the proper setting.
4. Connect the second jumper cable to the booster battery \ominus terminal.

Jump Starting Procedure

⚠ WARNING

A 12-volt battery can explode if you do not follow the correct procedure, seriously injuring anyone nearby.

Keep all sparks, open flames, and smoking materials away from the 12-volt battery.

NOTICE

If a 12-volt battery sits in extreme cold, the electrolyte inside can freeze. Attempting to jump start with a frozen 12-volt battery can cause it to rupture.

Securely attach the jumper cables clips so that they do not come off when the engine vibrates. Be careful not to tangle the jumper cables or allow the cable ends to touch each other while attaching or detaching the jumper cables.

Continued

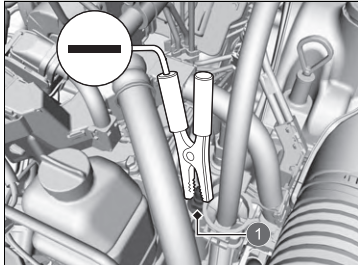

1 Stud Bolt

5. Connect the other end of the second jumper cable to the stud bolt as shown. Do not connect this jumper cable to any other part.
6. If your vehicle is connected to another vehicle, start the assisting vehicle's engine and increase its rpm slightly.
7. Attempt to start your vehicle's engine. If it turns over slowly, check that the jumper cables have good metal-to-metal contact.

▶▶ Jump Starting Procedure

12-volt battery performance degrades in cold conditions and may prevent the engine from starting.

■ What to Do After the Engine Starts

Once your vehicle's engine has started, remove the jumper cables in the following order.

1. Disconnect the jumper cable from your vehicle's stud bolt.
2. Disconnect the other end of the jumper cable from the booster battery ⊖ terminal.
3. Disconnect the jumper cable from your vehicle's 12-volt battery ⊕ terminal.
4. Disconnect the other end of the jumper cable from the booster battery ⊕ terminal.

Have your vehicle inspected by a nearby service station or a dealer.

⌘ Jump Starting Procedure

The indicators for the Adaptive Cruise Control (ACC) with Low Speed Follow, Vehicle Stability Assist (VSA) System, VSA OFF, Low Tyre Pressure/Deflation Warning System and Safety Support Indicator (Amber) may come on along with a message in the driver information interface when you turn the power system on after reconnecting the 12-volt battery. Drive a short distance at more than 20 km/h (12 mph). The indicator should go off. If it does not, have your vehicle checked by a dealer.

Shift Lever Does Not Move

Follow the procedure below if you cannot move the shift lever out of the **P** position.

Releasing the Lock

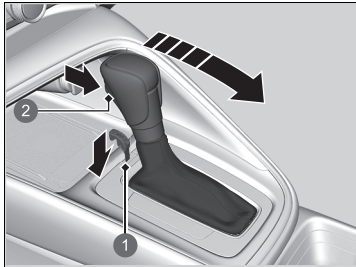



- 1 Shift Lock Release Slot
- 2 Release Button

1. Set the parking brake.
2. Set the power mode to VEHICLE OFF.
3. Remove the built-in key from the keyless remote.
4. Insert the key into the shift lock release slot.
5. While pushing the key down, press the shift lever release button, and place the shift lever into **N**.
 - ▶ The lock is now released. Have the shift lever checked by a dealer as soon as possible.

How to Handle Overheating

Overheating symptoms are as follows:

-  **High Temperature. Power Reduced.** appears on the driver information interface.
-  **Engine Temperature Too Hot. Allow Engine To Cool.** appears on the driver information interface.
- Steam or spray comes out of the engine compartment.

High Temperature. Power Reduced. Appears on the Driver Information Interface

 **High Temperature. Power Reduced.** appears on the driver information interface when the power system temperature is high.

1. Park the vehicle in a safe place.
 - ▶ Set the parking brake, and put the transmission into **P**. Turn off all accessories and turn on the hazard warning lights.
2. Keep the power mode in ON, and wait until the message disappears.
 - ▶ If the message does not disappear, have your vehicle inspected at a dealer.

Engine Temperature Too Hot. Allow Engine To Cool. Appears on the Driver Information Interface

■ First thing to do

1. Immediately park the vehicle in a safe place.
2. Turn off all accessories and turn on the hazard warning lights.
 - ▶ **No steam or spray present:** Keep the power system on and open the bonnet.
 - ▶ **Steam or spray is present:** Turn off the power system and wait until it subsides. Then, open the bonnet.

ⓘ How to Handle Overheating

WARNING

Steam and spray from an overheated engine can seriously scald you.

Do not open the bonnet if steam is coming out.

NOTICE

Continuing to drive with  **Engine Temperature Too Hot. Allow Engine To Cool.** on the driver information interface may damage the engine.

If  **High Temperature. Power Reduced.** appears on the driver information interface, your vehicle has less ability to accelerate and may be harder to start on an incline.

■ Next thing to do

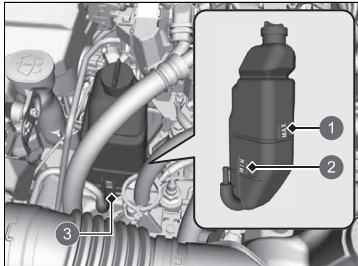

- 1 MAX
- 2 MIN
- 3 Reserve Tank

1. Check that the cooling fan is operating and turn the power system off once  **Engine Temperature Too Hot. Allow Engine To Cool.** on the driver information interface disappears.
 - If the cooling fan is not operating, immediately turn the power system off.
2. Once the engine has cooled down, inspect the coolant level and check the cooling system components for leaks.
 - If the coolant level in the reserve tank is low, add coolant until it reaches the **MAX** mark.
 - If there is no coolant in the reserve tank, check that the radiator is cool. Cover the radiator cap with a heavy cloth and open the cap. If necessary, add coolant up to the base of the filler neck, and put the cap back on.

■ Last thing to do

Once the engine has cooled sufficiently, turn the power system on. If  **Engine Temperature Too Hot. Allow Engine To Cool.** does not appear, resume driving. If it appears again, contact a dealer for repairs.

►► How to Handle Overheating

WARNING

Removing the radiator cap while the engine is hot can cause the coolant to spray out, seriously scalding you.

Always let the engine and radiator cool down before removing the radiator cap.

If the coolant is leaking, contact a dealer for repairs.

Use water as an emergency/temporary measure only. Have a dealer flush the system with proper antifreeze as soon as possible.

If the Engine Oil Pressure Low Warning Appears



■ Reasons for the warning to appear

Appears when the engine oil pressure is low.

■ What to do as soon as the warning appears

1. Immediately park the vehicle on level ground in a safe place.
2. If necessary, turn the hazard warning lights on.

■ What to do after parking the vehicle

1. Stop the power system and let it sit for approximately three minutes.
2. Open the bonnet and check the oil level.
 - ▶ Add oil as necessary.
 - ▶ **Oil Check** P. 522
3. Start the engine and check the **Engine Oil Pressure Low** warning.
 - ▶ The warning disappears: Start driving again.
 - ▶ The warning does not disappear within 10 seconds: Immediately stop the power system and contact a dealer for repairs.

If the 12-Volt Battery Charging System Indicator Comes On



■ Reasons for the indicator to come on

Comes on when the 12-volt battery is not charging.

■ What to do when the indicator comes on

Stop in a safe place and have your vehicle checked by a dealer immediately.

☒ If the Engine Oil Pressure Low Warning Appears

NOTICE

Running the engine with low oil pressure can cause serious mechanical damage almost immediately.

☒ If the 12-Volt Battery Charging System Indicator Comes On

If you need to stop temporarily, do not turn off the power system. The power system uses the 12-volt battery to activate. You may not be able to turn the power system on again if you have turned it off with this indicator on.

If the Reduced Stopping Power Warning Appears



■ Reasons for the warning to appear

Appears when braking ability is reduced.

■ What to do as soon as the warning appears

Slow down and drive carefully. Have your vehicle checked by a dealer.

If the Malfunction Indicator Lamp Comes On or Blinks



■ Reasons for the indicator lamp to come on or blink

- Comes on when there is a problem with the engine emissions control system or electric vehicle system.
- Blinks when engine misfiring is detected.

■ What to do when the indicator lamp comes on

- Avoid high speeds and immediately get your vehicle inspected at a dealer.

■ What to do when the indicator lamp blinks

Park the vehicle in a safe place with no flammable items and wait at least 10 minutes or more with the engine stopped until it cools.

⊗ If the Malfunction Indicator Lamp Comes On or Blinks

NOTICE

If you drive with the malfunction indicator lamp on, the emissions control system and the engine could be damaged.

If the malfunction indicator lamp blinks again when restarting the engine, drive to the nearest dealer at 50 km/h (30 mph) or less. Have your vehicle inspected.

If the Brake System Indicator (Red) Comes On or Blinks



■ Reasons for the indicator to come on

- The brake fluid is low.
- There is a malfunction in the brake system.

■ What to do when the indicator comes on while driving

Depress the brake pedal lightly to check pedal pressure.

- If normal, check the brake fluid level the next time you stop.
- If abnormal, take immediate action. If necessary, downshift the transmission to slow the vehicle using regenerative braking.

■ Reasons for the indicator to blink

- There is a problem with the electric parking brake system.

■ What to do when the indicator lamp blinks

- Avoid using the parking brake and have your vehicle checked by a dealer immediately.

☒ If the Brake System Indicator (Red) Comes On or Blinks

Have your vehicle repaired immediately.

It is dangerous to drive with low brake fluid. If there is no resistance from the brake pedal, stop immediately in a safe place. If necessary downshift the transmission.

If the Brake System Indicator (Red) and **ABS** indicator come on simultaneously, the electronic brake distribution system is not working. This can result in vehicle instability under sudden braking.

Have your vehicle inspected by a dealer immediately.

If the Brake System Indicator (Red) blinks at the same time when the Brake System Indicator (Amber) comes on, the parking brake may not work.

Avoid using the parking brake and have your vehicle checked by a dealer immediately.

- ☒ **If the Brake System Indicator (Red) Comes On or Blinks at the Same Time When the Brake System Indicator (Amber) Comes On**
P. 597

If the Electric Power Steering (EPS) System Indicator Comes On



■ Reasons for the indicator to come on

Comes on when there is a problem with the EPS system.

■ What to do when the indicator comes on

- Stop the vehicle in a safe place and turn on the power system again.
If the indicator comes on and stays on, immediately have your vehicle inspected by a dealer.
- If  **Do Not Drive** appears on the driver information interface, immediately stop in a safe place and contact a dealer.

If the Brake System Indicator (Red) Comes On or Blinks at the Same Time When the Brake System Indicator (Amber) Comes On



(Red)

■ **If the Brake System Indicator (Red) comes on or blinks at the same time when the Brake System Indicator (Amber) comes on, release the parking brake manually or automatically**

▶ **Parking Brake** P. 471



(Amber)

- If the Brake System Indicator (Red) continuously comes on or blinks at the same time when the Brake System Indicator (Amber) comes on, stop the vehicle in a safe place and have it inspected by a dealer immediately.
 - ▶ Preventing the vehicle from moving, put the transmission into **P**.
- If only the Brake System Indicator (Red) is turned off, avoid using the parking brake and have your vehicle checked by a dealer immediately.

▶▶ If the Brake System Indicator (Red) Comes On or Blinks at the Same Time When the Brake System Indicator (Amber) Comes On

If you apply the parking brake, you may not be able to release it.

If the brake system indicator (red) and the brake system indicator (amber) come on at the same time, the parking brake is working.

If the brake system indicator (red) blinks at the same time when the brake system indicator (amber) comes on, the parking brake may not work because it is checking the system.

If the Low Tyre Pressure/Deflation Warning System Indicator Comes On or Blinks



■ Reasons for the indicator to come on or blink

A tyre pressure is significantly low, or the deflation warning system has not been calibrated. If there is a problem with the deflation warning system, the indicator blinks for about one minute, and then stays on.

■ What to do when the indicator comes on

Drive carefully and avoid abrupt cornering and hard braking.

Stop your vehicle in a safe place. Check the tyre pressure and adjust the pressure to the specified level. The specified tyre pressure is on a label on the driver side doorjamb.

- ▶ Calibrate the deflation warning system after the tyre pressure is adjusted.

🔧 **Deflation Warning System** P. 392

■ What to do when the indicator blinks, then remains on

Have the tyre inspected by a dealer as soon as possible.

🔧 If the Low Tyre Pressure/Deflation Warning System Indicator Comes On or Blinks

NOTICE

Driving on an extremely underinflated tyre can cause it to overheat. An overheated tyre can fail. Always inflate your tyres to the prescribed level.

If the Engine Oil Level Low Warning Appears



■ Reasons for the warning to appear

Appears when the engine oil level is low.

■ What to do as soon as the warning appears

1. Immediately park the vehicle on level ground in a safe place.
2. If necessary, turn the hazard warning lights on.

■ What to do after parking the vehicle

1. Stop the power system and let it sit for about three minutes.
2. Open the bonnet and check the oil level.
 - ▶ Add oil as necessary.
 - 📖 **Oil Check** P. 522

📖 If the Engine Oil Level Low Warning Appears

NOTICE

Running the engine with low oil level can cause serious mechanical damage almost immediately.

This system activates after the engine warms up. If the outside temperature is extremely low, you may have to drive for a long time until the system senses the engine oil level.

If the warning appears again, stop the engine and contact a dealer for repairs immediately.

Fuse Locations

If any electrical devices are not working, set the power mode to VEHICLE OFF (LOCK) and check to see if any applicable fuse is blown.

■ Engine Compartment Fuse Box

■ Fuse box A

Located near the 12-volt battery. Push the tabs to open the box.

Locate the fuse in question by the fuse number and box cover number.

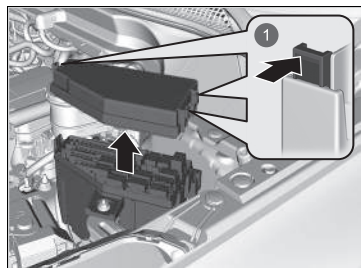

1 Tabs

■ Circuit protected and fuse rating

		Circuit Protected	Amps
1		Wiper	30 A
2		Left LCM	15 A
3		Hazard	10 A
4		Stop	10 A
5		PCU EWP	15 A
6	–	–	–
7		EVTC	20 A
8		IGP	15 A
9		IG Coil	15 A
10		DBW	15 A
11		ABS/VSA MTR	40 A
12		Main Fan	30 A
13		Engine Water Pump	30 A
14		Keyless Access	10 A
15		Battery Sensor	7.5 A
16		Right LCM	15 A
17		Back Up FI-ECU	10 A
18		Horn	10 A
19		Sub Audio	(7.5 A)
20		Front Fog Lights*	(10 A)

		Circuit Protected	Amps
21		Audio	15 A
22		Back Up	15 A
23		Sub Fan	30 A
24		ABS/VSA FSR	40 A
25		IGP2 Sub	7.5 A
26		LAF	10 A
27	–	–	–
28	–	–	–
29	–	–	–
30	–	–	–
31	–	–	–
32	–	–	–
33	–	–	–

■ **Fuse box B**

Located near the ⊕ terminal of the 12-volt battery.

Have a dealer inspect and replace the fuse.

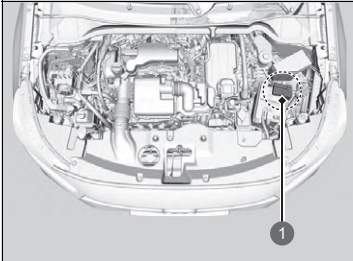

① Fuse Box

■ **Circuit protected and fuse rating**

		Circuit Protected	Amps
a		Battery Main	170 A
b		Battery Main (Fan)	60 A
c		Battery Main (ENG)	80 A
d		Battery Main (HEV)	60 A
e		EPS	70 A
f		ESB	40 A

■ Driver Side Interior Fuse Box

■ Type A

Located under the dashboard.

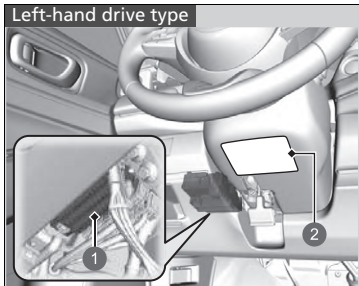

- 1 Fuse Box
- 2 Fuse Label

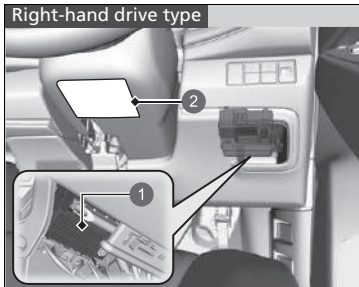

- 1 Fuse Box
- 2 Fuse Label

Fuse locations are shown on the label under the steering column.

Locate the fuse in question by the fuse number and label number.

■ Circuit protected and fuse rating

		Circuit Protected	Amps
1		Accessory	7.5 A
2		ACC Key Lock	7.5 A
3		Blind spot information System*	(10 A)
4		LCM*	(5 A)
5		Option	10 A
6		Option 2	10 A
7		Meter	10 A
8		Fuel Pump	15 A
9		AIRCON	10 A
10		–	(20 A)
11		MON	5 A
12		Right Side Door Lock	10 A
13		Left Side Door Unlock	10 A
14		Rear Left Side Power Window	20 A
15		Front Passenger's Power Window	20 A
16		Door Lock	20 A
17		Transmission	10 A
18		USB Charger*	(10 A)

		Circuit Protected	Amps
19		Super Locking*	(20 A)
20		Starter Cut Relay	7.5 A
21		ACG	10 A
22		Daytime Running Lights	7.5 A
23		Rear Fog Light	(10 A)
24		Option	10 A
25		–	(10 A)
26		Right Side Door Unlock	10 A
27		Rear Right Side Power Window	20 A
28		Driver's Power Window	20 A
29		Front Accessory Power Socket	(20 A)
30		Heated Windscreen*	(10 A)
31		–	(20 A)
32		Front Seat Heater	(20 A)
33		–	(20 A)
34		VSA/ABS	10 A
35		SRS	10 A
36		–	(20 A)
37		Heated Steering Wheel*	(15 A)
38		Left Side Door Lock	10 A
39		–	(10 A)

Left-hand drive type

■ Type B

Located under the dashboard.

Only the fuse No. 1 is outside of the fuse box.

Replacement of this fuse should be done by a dealer.

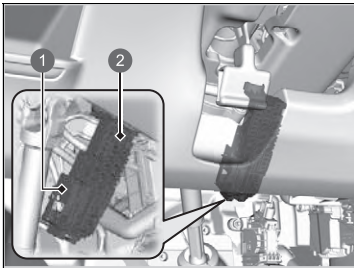

- ❶ Fuse No. 1
- ❷ Fuse No. 2-25

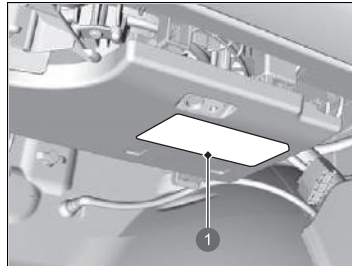

❶ Fuse Label

Fuse locations are shown on the label under the glove box.

Locate the fuse in question by the fuse number and label number.

		Circuit Protected	Amps
1		Fuse Box Main	60 A
2		IG Main	30 A
3		IG Main 2	30 A
4		Relay Module 1	30 A
5		Relay Module 2	30 A
6		Fuse Box Main 2	40 A
7		Fuse Box Option	(40 A)
8		Heater Motor	30 A
9		A/C PTC1	(40 A)
10		Rear Demister	30 A
11		A/C PTC2	(40 A)
12	–	–	–
13		Power Tailgate Motor*	(40 A)
14		SRS	10 A
15		IG HOLD1	10 A
16		IG HOLD3	10 A
17		IMG	10 A
18		Audio Amp*	(20 A)
19	–	–	–
20	–	–	–
21		Power Tailgate Closer*	(20 A)
22		IG HOLD2	15 A
23		Washer	(15 A)
24		–	(10 A)
25	–	–	–

* Not available on all models

Right-hand drive type

Passenger Side Interior Fuse Box

Located under the dashboard.

Only the fuse No. 1 is outside of the fuse box. Replacement of this fuse should be done by a dealer.

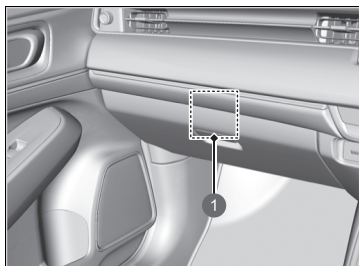

1 Fuse No. 1

The fuses other than No.1 are under the dashboard.

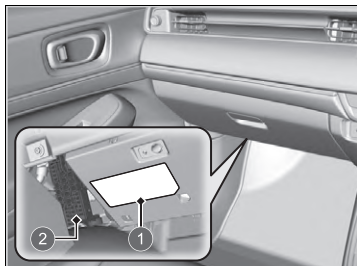

- 1 Fuse Label
- 2 Fuse No. 2-25

Fuse locations are shown on the label. Locate the fuse in question by the fuse number and label number.

		Circuit Protected	Amps
1		Fuse Box Main	60 A
2		IG Main	30 A
3		IG Main 2	30 A
4		Relay Module 1	30 A
5		Relay Module 2	30 A
6		Fuse Box Main 2	40 A
7		Fuse Box Option	(40 A)
8		Heater Motor	30 A
9		–	(40 A)
10		Rear Demister	30 A
11		–	(40 A)
12	–	–	–
13		Power Tailgate Motor*	(40 A)
14		SRS	10 A
15		IG HOLD1	10 A
16		IG HOLD3	10 A
17		IMG	10 A
18		Audio Amp*	(20 A)
19	–	–	–
20	–	–	–
21		Power Tailgate Closer*	(20 A)
22		IG HOLD2	15 A
23		Washer	(15 A)
24		–	(10 A)
25	–	–	–

Inspecting and Changing Fuses

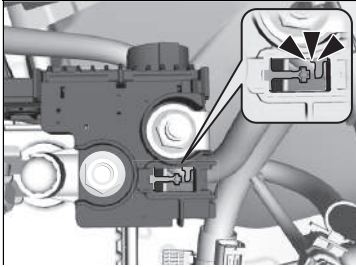

1. Set the power mode to VEHICLE OFF (LOCK). Turn the headlights and all accessories off.
2. Remove the cover on the ⊕ terminal.
3. Check the fuses on the battery in the engine compartment.
 - ▶ If the fuse is blown, have it replaced by a dealer.

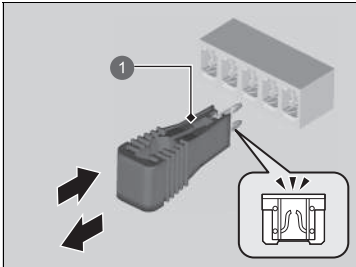

1 Fuse Puller

4. Remove the fuse box cover.
5. Inspect the small fuses in the engine compartment and the vehicle interior.
 - ▶ If there is a blown fuse, remove it with the fuse puller and replace it with a new one.

Inspecting and Changing Fuses

NOTICE

Replacing a fuse with one that has a higher rating greatly increases the chances of damaging the electrical system.

Use the charts to locate the fuse in question and confirm the specified amperage on the fuse label.

➤ **Fuse Locations** P. 600

Replace fuse with a spare fuse of the same specified amperage.

There is a fuse puller on the back of the cover of the engine compartment fuse box A.

Call a professional towing service if you need to tow your vehicle.

■ Flatbed equipment

The operator loads your vehicle on the back of a truck.

This is the best way to transport your vehicle.

■ Wheel lift equipment

The tow truck uses two pivoting arms that go under the front tyres and lift them off the ground. The rear tyres remain on the ground. **This is an acceptable way to tow your vehicle.**

» Emergency Towing

NOTICE

Trying to lift or tow your vehicle by the bumpers will cause serious damage. The bumpers are not designed to support the vehicle's weight.

Make sure the parking brake is released. If you cannot release the parking brake, your vehicle must be transported by the flatbed equipment.

➤ **Parking Brake** P. 471

Improper towing such as towing behind a motorhome or other motor vehicle can damage the transmission.

Never tow your vehicle with just a rope or chain. It is very dangerous since ropes or chains may shift from side to side or break.

If You Cannot Open the Tailgate

■ What to Do If Unable to Open the Tailgate

If you cannot open the tailgate, use the following procedure.

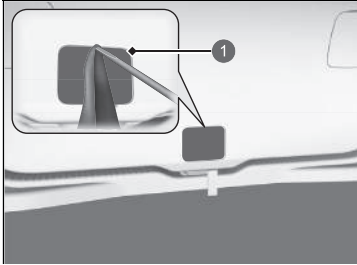

1 Lid

1. Use a flat-tip screwdriver and open the lid on the back of the tailgate.

- ▶ Wrap the flat-tip screwdriver with a cloth to prevent scratches.

☒ What to Do If Unable to Open the Tailgate

Following up:

After taking these steps, contact a dealer to have the vehicle checked.

When you open the tailgate from inside, make sure there is enough space around the tailgate, and it does not hit anyone or any object.

Continued

▶▶ If You Cannot Open the Tailgate ▶



1 Lever

2. To open the tailgate, push the tailgate while sliding the lever to the right with the flat-tip screwdriver.



1 Lever

Information

This chapter includes your vehicle's specifications, locations of identification numbers, and other information required by regulation.

Specifications	610
Identification Numbers	
Vehicle Identification Number (VIN), Engine Number, Motor Number and Transmission Number.....	612
Devices that Emit Radio Waves*	613
Declaration of conformity Content Outline*	655

* Not available on all models

■ Vehicle Specifications

Model	HR-V
Curb Weight	1,377 - 1,398 kg (3,036 - 3,802 lbs) ^{*1}
	1,378 - 1,397 kg (3,038 - 3,080 lbs) ^{*2}
Maximum Permissible Weight	See the certification label on the driver's doorjamb ^{*1} See the certification label on the passenger's doorjamb ^{*2}
Maximum Permissible Axle Weight	See the certification label on the driver's doorjamb ^{*1} See the certification label on the passenger's doorjamb ^{*2}

*1: Left-hand drive type

*2: Right-hand drive type

■ Engine Specifications

Type	Water-cooled in-line 4-cylinder DOHC	
Bore x Stroke	73.0 x 89.5 mm (2.87 x 3.52 in)	
Displacement	1,498 cm ³ (91.4 cu-in)	
Compression Ratio	13.5 : 1	
Spark Plugs	NGK	DILZKAR7C11H
	DENSO	DXE22HCR11H

■ Fuel

Type	<ul style="list-style-type: none"> EN 228 standards petrol/gasohol fuel Unleaded premium petrol/gasohol up to E10 (90% petrol and 10% ethanol), research octane number 95 or higher
Fuel Tank Capacity	40 L (8.8 Imp gal)

■ 12-volt Battery

Capacity	32AH(5)/40AH(20)
----------	------------------

■ Washer Fluid

Tank Capacity	2.5 L (2.2 Imp qt)
---------------	--------------------

■ Light Bulbs

Headlights (Low Beam)	LED
Headlights (High Beam)	LED
Position/Daytime Running Lights	LED
Front Turn Signal Lights	LED
Active Cornering Lights*	LED
Front Fog Lights*	LED
Side Turn Signal Lights (on Door Mirrors)	LED
Brake Lights	LED
Taillights	LED
Rear Turn Signal Lights	21 W (Amber)
Back-Up Light	16 W
Rear Fog Light	LED
Rear Licence Plate Light	LED
High-Mount Brake Light	LED
Interior Lights	
Front and Rear Map lights	LED
Vanity Mirror Lights	2.3 W
Centre Pocket Light	LED
Luggage Area Lights	LED

■ Brake Fluid

Specified	Brake Fluid with DOT 3 or DOT 4
-----------	---------------------------------

■ Air Conditioning

Refrigerant Type	HFO-1234yf (R-1234yf)
Charge Quantity	395 - 445 g (13.9 - 15.7 oz)

■ Transmission Fluid

Specified	Honda ATF DW-1
Capacity	Change 1.8 L (1.6 Imp qt)

■ Engine Oil

Recommended	European and Ukrainian models
	Honda Engine Oil Type 2.0 ACEA C5 0W-20
Capacity	Except European and Ukrainian models
	Honda Genuine Motor Oil 0W-20 ACEA C5 0W-20
	Change 3.4 L (3.0 Imp qt)
	Change including filter 3.6 L (3.2 Imp qt)

■ Engine Coolant

Specified	Honda All Season Antifreeze/Coolant Type2
Ratio	50/50 with distilled water
Capacity	4.22 L (0.93 Imp gal)
	(change including the remaining 0.45 L (0.10 Imp gal) in the reserve tank)

■ Tyre

	Size	225/50R18 95V
Regular	Pressure	See the label on driver's doorjamb
Wheel Size	Regular	18 x 7 1/2J

■ Honda TRK Air Compressor

A weighted emission sound pressure level	81 dB (A)
A weighted sound power level	89 dB (A)

■ Brake

Type	Power assisted
Front	Ventilated disc
Rear	Solid disc
Parking	Electric Parking Brake

■ Vehicle Dimensions

Length	4,340 mm (170.9 in)
Width	1,790 mm (70.5 in)
Height	1,582 mm (62.3 in)
Wheelbase	2,610 mm (102.8 in)
Track	Front 1,535 mm (60.4 in)
	Rear 1,540 mm (60.6 in)

Vehicle Identification Number (VIN), Engine Number, Motor Number and Transmission Number

Your vehicle has a 17-digit vehicle identification number (VIN) used to register your vehicle for warranty purposes, and for licensing and insuring your vehicle. The locations of your vehicle's VIN, engine number, motor number and transmission number are shown as follows.

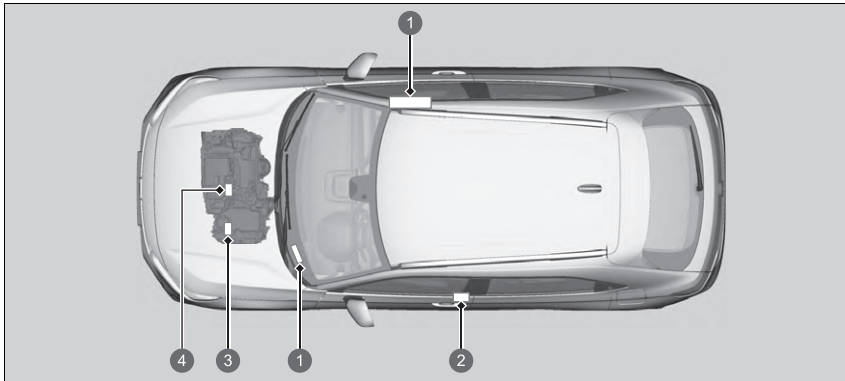

- ① Vehicle Identification Number
- ② Certification Label/Vehicle Identification Number/Engine Number
- ③ Transmission Number
Motor Number
- ④ Engine Number

Vehicle Identification Number (VIN), Engine Number, Motor Number and Transmission Number

The interior vehicle identification number (VIN) is located under the cover.

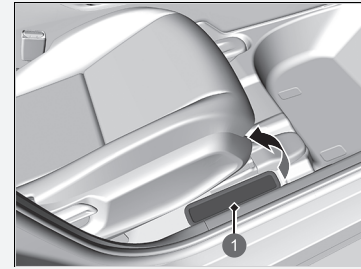

- ① Cover

Devices that Emit Radio Waves*

The following products and systems on your vehicle emit radio waves when in operation.

Guadeloupe, Macedonia, Martinique, Monaco, and Motenegro models

BCM Keyless Access System	FOB Keyless Access System
http://continental-homologation.com/honda	http://continental-homologation.com/honda
	
<p>Hereby, Continental Automotive GmbH declares that this model [41580430] is in compliance with the essential requirements and other relevant provisions of Directive 2014/53/EU.</p>	<p>Hereby, Continental Automotive GmbH declares that this model [TP_4] is in compliance with the essential requirements and other relevant provisions of Directive 2014/53/EU.</p>
<p>The full text of the EU declaration of conformity is available at the following internet address: https://continental-homologation.com/honda</p>	<p>The full text of the EU declaration of conformity is available at the following internet address: https://continental-homologation.com/honda</p>
<p>Instructions and safety information:</p>	<p>Instructions and safety information:</p>
<p>Short range device for remote control</p>	<p>Short range device for remote control</p>
<p>Postal address:</p>	<p>Postal address:</p>
<p>Siemensstrasse 12</p>	<p>Siemensstrasse 12</p>
<p>D-93055 Regensburg</p>	<p>D-93055 Regensburg</p>
<p>Germany</p>	<p>Germany</p>
<p>Manufacturer name:</p>	<p>Manufacturer name:</p>
<p>Continental Automotive GmbH</p>	<p>Continental Automotive GmbH</p>
<p>Frequency band: 125KHz</p>	<p>Frequency band: 433.92MHz</p>
<p>Maximum transmitted output: 10mW</p>	<p>Maximum transmitted output: 1mW</p>
<p>Importer Name:</p>	<p>Importer Name:</p>
<p>Honda Motor Europe Ltd - Aalst Office</p>	<p>Honda Motor Europe Ltd - Aalst Office</p>
<p>Postal address:</p>	<p>Postal address:</p>
<p>Wijngaardveld 1 (Noord V) 9300 Aalst - Belgium</p>	<p>Wijngaardveld 1 (Noord V) 9300 Aalst - Belgium</p>

* Not available on all models

Guadeloupe, Macedonia, Martinique, Monaco, and Motenegro models

CARD
Keyless Access System



Instructions and safety information:
 Short range device for remote control
 Postal address:
 45-29, SaEum-Road, Icheon-City, Gyeonggi-do, Korea
 Manufacturer name:
 Continental Automotive Systems Corporation
 Frequency band: 433.92MHz
 Maximum transmitted output: 1mW
 Importer Name:
 Honda Motor Europe Ltd - Aalst Office
 Postal address:
 Wijngaardveld 1 (Noord V) 9300 Aalst - Belgium

EU Declaration of Conformity 

Product details

Product: CARD ASSY ENTRY KEY

Model: SV140CF000

We hereby declare, that the product above is in compliance with the essential requirements of the Directive 2014/53/EU by application of:

Applied Standards

Article 3.2
 Radio: EN 302 220-1 V2.1.1, EN 300 220-2 V2.1.1, EN 302 330 V2.1.1

Article 3.3b
 EMC: EN 301 489-1 V2.1.1, EN 301 489-3 V2.1.1

Article 3.3a
 Safety, Health: EN 62368-1:2020+A11:2020, EN 61973:2020

Manufacturer

Continental Automotive Systems Corporation
 45-29, SaEum-ro
 Icheon-si, Gyeonggi-do, 17308, Korea
 Tel: +82-31-845-8804

Representation in the EU

Continental Automotive GmbH
 Siemensstraße 17
 D-93055 Regensburg Germany
 Tel: +49-941-750-9354

Signed By 21/07/2020

This declaration of conformity is issued under the sole responsibility of the manufacturer.

 S. M. Jang
 Representative
 Continental Automotive
 Systems Corporation



Serbian models

BCM
Keyless Access System

KVALITET Akcionarsko društvo za ispitivanja kvaliteta "KVALITET" MB
Акционарско друштво за испитивање квалитета "КВАЛИТЕТ" МБ
Joint-stock company for quality testing "KVALITET" MB

POTVRDA O USAGLAŠENOSTI - RITTO Broj: P1615061800
CONFIRMATION OF CONFORMITY - RITTE No.

Podnosilac zahteva: RITTE CONSULTING DOO Broj: 11000 BEČUŠKA
Applicant: 11000 BEČUŠKA MNRICKA 28/29

Vrsta opreme: KONTROLNI MODUL
Equipment category:

Oznaka tipa/modela: 4073700
Equipment type/model:

Robna marka: Continental
Equipment trademark:
Proizvođač: Continental Automotive GmbH
Manufacturer: NEMACKA

Vrednovana dokumentacija / Evaluated documentation:
Laboratorija/ ispitni izveštaj: Bezbednost/Safety: CSA Group Bayern GmbH
Laboratory/ test report: EMI/EMC: CSA Group Bayern GmbH
RTTU/RITTE: CSA Group Bayern GmbH

Na osnovu gore navedene dokumentacije utvrđeno je da gore navedena oprema zadovoljava zahtevne Priloge A radio opreme i dodatne tehničke specifikacije iz lista RITTE za radio opremu. (On the basis of the above mentioned documentation it is found that above mentioned equipment fulfils the requirements of the Rulesbook on Radio Equipment and Telecommunications Technical Equipment Category No. 110010.)

Na osnovu promena u specifikaciji, izvođača, komponentama, električnih karakteristika opreme koji utiču na usaglašenost sa navedenim Prilozima moguće je izvesti "Kvalitet" u s.l. MB. Any changes occur in the specification, manufacturer, components or electrical construction which may influence on conformity to the above mention Rulesbook, shall be forwarded to "Kvalitet".

Mesto i datum izdavanja: Vršiti do: 15.05.2015.
Place and date: Valid until: 15.05.2015.

Dr. Svetozar Čeranić
Vladimir Vučkosić, dipl. inž.

Bil. Svetozar Čeranić
Bil. Svetozar Čeranić

Bil. Svetozar Čeranić
Bil. Svetozar Čeranić

Bil. Svetozar Čeranić
Bil. Svetozar Čeranić

FOB
Keyless Access System

KVALITET Akcionarsko društvo za ispitivanja kvaliteta "KVALITET" MB
Акционарско друштво за испитивање квалитета "КВАЛИТЕТ" МБ
Joint-stock company for quality testing "KVALITET" MB

POTVRDA O USAGLAŠENOSTI - RITTO Broj: P1620075800
CONFIRMATION OF CONFORMITY - RITTE No.

Podnosilac zahteva: RITTE CONSULTING DOO Broj: 11000 BEČUŠKA-TRNOVICA
Applicant: 11000 BEČUŠKA-TRNOVICA KNEŽEV-SUSLAVA 692/7

Vrsta opreme: KLJUČ ZA DALJINSKI PRISTUP VOZILU
Equipment category:

Oznaka tipa/modela: TP_4
Equipment type/model:

Robna marka: Continental
Equipment trademark:
Proizvođač: Continental Automotive GmbH
Manufacturer: Germany

Vrednovana dokumentacija / Evaluated documentation:
Laboratorija/ ispitni izveštaj: Bežbednost/Safety: Conformity Certification Services Inc. T200415W01-LV, 11.05.2020./
Laboratory/ test report: EMI/EMC: Conformity Certification Services Inc. T200415W01-RE, 07.05.2020./
RTTU/RITTE: Conformity Certification Services Inc. T200415W01-R11, 07.05.2020./ T200415W01-R12, 07.05.2020./

Na osnovu gore navedene dokumentacije utvrđeno je da gore navedena oprema zadovoljava zahtevne Priloge A radio opreme i dodatne tehničke specifikacije iz lista RITTE za radio opremu. (On the basis of the above mentioned documentation it is found that above mentioned equipment fulfils the requirements of the Rulesbook on Radio Equipment and Telecommunications Technical Equipment Category No. 110010.)

Na osnovu promena u specifikaciji, izvođača, komponentama, električnih karakteristika opreme koji utiču na usaglašenost sa navedenim Prilozima moguće je izvesti "Kvalitet" u s.l. MB. Any changes occur in the specification, manufacturer, components or electrical construction which may influence on conformity to the above mention Rulesbook, shall be forwarded to "Kvalitet".

Mesto i datum izdavanja: Vršiti do: 20.05.2020.
Place and date: Valid until: 20.05.2020.

Dr. Svetozar Čeranić
Vladimir Vučkosić, dipl. inž.

Bil. Svetozar Čeranić
Bil. Svetozar Čeranić



Bil. Svetozar Čeranić
Bil. Svetozar Čeranić

Bil. Svetozar Čeranić
Bil. Svetozar Čeranić

Serbian models

CARD
Keyless Access System

KVALITET Akcionarsko društvo za ispitivanje kvaliteta KVALITET NS
Акционарско друштво за испитивање квалитета КВАЛИТЕТ НС
Joint-stock company for quality testing KVALITET NS

POTVRDA O USAGLAŠENOSTI - RITTO Broj: **P1620135200**
CONFIRMATION OF CONFORMITY - R&TTE №: **P1620135200**

Podnosilac zahteva: ACEMA Consulting d.o.o.
Applicant: 11000 Beograd, BSK-11 Grad
Hlandarska 1

Vrsta opreme: KLJUČ ZA DALJINSKI PRESTUP VOZILU
Equipment category: Remote key for car

Oznaka tipa/modela: CARD ASSY ENTRY KEY / SHHCF0600
Equipment type/model: CARD ASSY ENTRY KEY / SHHCF0600

Robna marka: HONDA
Equipment trademark: Honda

Proizvođač: Continental Automotive System Corporation
Manufacturer: Korea

Vrednovana dokumentacija: Evaluated documentation:
Bezbednosni/Safety: OTC&B Co., Ltd. 01-207-4930-424, 17.07.2020./
OT&B Co., Ltd. DT&C/2020-0116, 20.03.2020./
EM&MC: OTC&B Co., Ltd. 01-207-4930-424, 17.07.2020./
R&TTE/ULTE: OTC&B Co., Ltd. 01-207-4930-424, 17.07.2020./

Laboratorijski izveštaji (level): Laboratory Test report:
01-207-4930-424, 17.07.2020./
EM&MC: OTC&B Co., Ltd. 01-207-4930-424, 17.07.2020./
R&TTE/ULTE: OTC&B Co., Ltd. 01-207-4930-424, 17.07.2020./

Na osnovu gore navedene dokumentacije utvrđeno je da gore navedena oprema zadovoljava zahtevne Pravilnike radio opreme i telekomunikacionih terminalnih uređaja (3. glava, 92. i 109.12).
On the basis of the above mentioned documentation it is concluded that the requirements of the Radio Equipment and Telecommunication Terminal Equipment (Other Radio) (R&TTE) are fulfilled.

Navedene promene u specifikaciji, konstrukciji, sastavnim delovima, električnim karakteristikama opreme koji utiču na usaglašenost sa navedenim Pravilnikom moraju se prijaviti "Kvalitet" u s.d. NS.
Any changes occur in the specifications, construction, components of the high electrical construction which may influence on conformity to the above-mentioned Rules, shall be reported to "Kvalitet".

Mesto i datum islevaranja: Vršiti op: 01.08.2023.
Place and date: Vršiti op: 01.08.2023.

Generalni direktor
Vladimir Vukobratović, dipl. inž.

Ovaj dokument važi samo za proizvodnja koji su izdvojeni sa proizvodima koji su bili predmet vrednovanja.
But this document is valid only for production which were separated from products which were subject of evaluation.
Bul. Svetog Cara Konstantina II-og, №1 16000, Srbija. Tel: 018(650)780, 550-624, Fax: 018(650)636, 630-596
www.kvalitet.co.rs

Wireless Charger*

KVALITET Akcionarsko društvo za ispitivanje kvaliteta KVALITET NS
Акционарско друштво за испитивање квалитета КВАЛИТЕТ НС
Joint-stock company for quality testing KVALITET NS

POTVRDA O JSAGLAŠENOSTI - RITTO Broj: **P1620059700**
CONFIRMATION OF CONFORMITY - R&TTE №: **P1620059700**

Podnosilac zahteva: INŽENJERSKE DELATNOSTI I TEHNIČKO SAVETOVANJE IN TECH
Applicant: 11211 BEOGRAD, BSK&A
B&T № 30/11144

Vrsta opreme: BEPČIĆI PUNJAČ
Equipment category: Wireless charger

Oznaka tipa/modela: WC009H0021
Equipment type/model: WC009H0021

Robna marka: LG
Equipment trademark: LG

Proizvođač: LG ELECTRONICS INC.
Manufacturer: Korea

Vrednovana dokumentacija: Evaluated documentation:
Bezbednosni/Safety: Nemko Korea Co., Ltd. 084347, 26.03.2020./
OT&B Co., Ltd. DT&C/2020-0116, 20.03.2020./
EM&MC: OTC&B Co., Ltd. DT&C/2020-0116, 20.03.2020./
R&TTE/ULTE: DT&C Co., Ltd. DT&C/2020-0116, 20.03.2020./

Laboratorijski izveštaji (level): Laboratory Test report:
084347, 26.03.2020./
DT&C Co., Ltd. DT&C/2020-0116, 20.03.2020./
EM&MC: OTC&B Co., Ltd. DT&C/2020-0116, 20.03.2020./
R&TTE/ULTE: DT&C Co., Ltd. DT&C/2020-0116, 20.03.2020./

Na osnovu gore navedene dokumentacije utvrđeno je da gore navedena oprema zadovoljava zahtevne Pravilnike o radio opremi i telekomunikacionim terminalnim uređajima (3. glava, 92. i 109.12).
On the basis of the above mentioned documentation it is concluded that the requirements of the Radio Equipment and Telecommunication Terminal Equipment (Other Radio) (R&TTE) are fulfilled.

Navedene promene u specifikaciji, konstrukciji, sastavnim delovima, električnim karakteristikama opreme koji utiču na usaglašenost sa navedenim Pravilnikom moraju se prijaviti "Kvalitet" u s.d. NS.
Any changes occur in the specifications, construction, components of the design, electrical construction which may influence on conformity to the above-mentioned Rules, shall be reported to "Kvalitet".

Mesto i datum islevaranja: Vršiti op: 20.04.2023.
Place and date: Vršiti op: 20.04.2023.

Generalni direktor
Vladimir Vukobratović, dipl. inž.

Ovaj dokument važi samo za proizvodnja koji su izdvojeni sa proizvodima koji su bili predmet vrednovanja.
But this document is valid only for production which were separated from products which were subject of evaluation.
Bul. Svetog Cara Konstantina II-og, №1 16000, Srbija. Tel: 018(650)780, 550-624, Fax: 018(650)636, 630-596
e-mail: ofisa@kvalitet.co.rs http://www.kvalitet.co.rs

Information

* Not available on all models

Serbian models

Telematics Control Unit

Blind spot information System*/Cross Traffic Monitor*

Овиме, DENSO CORPORATION изјављује да је радио опрема тип усаглашена са Директивом 2014/53/EU. Цео текст ЕУ декларације о усаглашености доступам је на следећој интернет адреси:
<https://www.denso.com/global/en/contact-us/doc/>

Upravna laboratorija d.o.o. Beograd
 Bulevar 15. 11000 Beograd
 tel: +381 11 8779320
www.upravna-lab.com
 certifikaciona telo



U 038 20



IADR
 IADR Beograd
 Institut za
 Akustiku i
 Akustičku
 Inženjeringu

POTVRDA O USAGLAŠENOSTI broj: 00334 00787

DATUM IZDAVANJA: 05.08.2023. VAŽI DO: 05.08.2025.

PODNOŠILAC ZAHTEVA: RTE Consulting d.o.o.
 Kraljeva Vilevača 63/2, 7, 11080 Beograd

NAZIV / VRSTA OPREME: Radar za vozilo u RF opsegu 24 GHz (24 GHz SRS Radar Sensor)

ROBNA MARKA: Veoneer

PROIZVOĐAČ: Veoneer U.S., Inc.
 20300 American Drive, Southfield, Michigan, 48034
 United States of America

TIPOLOGIJA / MODEL: NR340175V3

Prilogom dole navedene tehničke dokumentacije dostavljene od strane podnosioca zahteva, utvrđeno je usaglašenost opreme sa bitnim zahtevima Pravilnika o radio opremi i terminalnoj telekomunikacionoj opremi (Službeni glasnik RG br. 11/2012):

Ime dokumenta	Ime od	Datuma	Datum
Health Assessment report	ES-Lab GmbH	20021805-13643-1	29.06.2023.
Safety test report	ES-Lab GmbH	10083300-12742-3	14.06.2023.
EMC test report	CETECOM GmbH	19-1-0207401101a	23.06.2023.
RF test report	CETECOM GmbH	19-1-0207401102a	24.06.2023.
EU-Type Examination Certificate	KL-Certification GmbH	T.2020.06.0016	29.06.2023.

Mesto izdavanja:
Beograd



Državni

 Seta Jorgovanović, dipl. inž. ELE

Datum: 05.08.2023.
 *Oprema se ne može koristiti bez dodatne opreme koja omogućava ispunjenje svih zahteva iz Pravilnika koji se odnose na opremu za radio opremu i terminalnu telekomunikacionu opremu.

Serbian models

Hands-Free Telephone System

Panasonic

EU Declaration of Conformity
Document Number: PAS-000011-01

Manufacturer

Name : Panasonic Corporation
Address : 428 Sorokubo-cho, Tsuzuki-ku, Yokohama-shi, Kanagawa-ken,224-8520, Japan

Object of Declaration < A >

Product Name : CAR AUDIO/UNIT ASSY DA)
Trade Name : Panasonic
Model Number : CL-WH1AEJUT, CL-MH1AEJUT, CL-MH1AEJUT, CL-MH1AEJUT, CL-MH1AEJUT
Model ID : CL-WH1AEJUT, CL-MH1AEJUT, C-WH1BEJUT, CL-MH1BEJUT
Type Number : same as Model Number

CE Requirements

This declaration of conformity is issued under the sole responsibility of manufacturer. The object of the declaration described above is in conformity with the requirements of the following EU legislation and harmonized standards:

Council Directive(s) : 2014/53/EU RED < B >

Applicable Standard(s)
EN 62369-1:2014 + A11:2017, EN 62311:2008, EN 301 488-1 V2.1.1:2017
EN 301 488-3 V2.1.1:2017, EN 301 488-17 V3.1.1:2017, EN 301 488-19 V2.1.0:2017
EN 300 328 V2.1.1:2016, EN 301 893 V2.1.1:2017, EN 300 440 V2.1.1:2017
EN 302 413 V1.1.1:2017 < C >

Notified Body
NCCB Lab Inc. Number: 2380
Type Examination Certificate No. DEKR201 / 18 Jun 2020 / Rev A

Additional Information < D >

2020.8.19 *Niels Erdmann*
Date of Issue / Signature

24.Aug.2020 *Niels Erdmann*
Date of Issue / Signature

Owner Address / manager
Niels Erdmann
Authorized Representative
Panasonic Testing Centre
Panasonic Marketing Europe GmbH
Winkelring 18, 22625 Hamburg, Germany

Panasonic

EU Declaration of Conformity
Document Number: PAS-00004-01

Manufacturer

Name : Panasonic Corporation
Address : 428 Sorokubo-cho, Tsuzuki-ku, Yokohama-shi, Kanagawa-ken,224-8520, Japan

Object of Declaration < A >

Product Name : CAR AUDIO/UNIT ASSY DA)
Model Number : CL-MH1BEJUT, CL-MH1BEJUT, CL-MH1BEJUT, CL-MH1BEJUT
Model ID : A0001
Type Number : same as Model Number

CE Requirements

This declaration of conformity is issued under the sole responsibility of manufacturer. The object of the declaration described above is in conformity with the requirements of the following EU legislation and harmonized standards:

Council Directive(s) : 2014/53/EU RED < B >

Applicable Standard(s)
EN 62369-1:2014 + A11:2017, EN 62311:2008, EN 301 488-1 V2.1.1:2017
EN 301 488-3 V2.1.1:2017, EN 301 488-17 V3.1.1:2017, EN 301 488-19 V2.1.0:2017
EN 300 328 V2.1.1:2016, EN 301 893 V2.1.1:2017, EN 300 440 V2.1.1:2017
EN 302 413 V1.1.1:2017 < C >

Notified Body
NCCB Lab Inc. Number: 2380
Type Examination Certificate No. DEKR201 / 18 Jun 2020 / Rev A

Additional Information < D >

2020.8.7 *Niels Erdmann*
Date of Issue / Signature

09.Aug.2020 *Niels Erdmann*
Date of Issue / Signature

Owner Address / manager
Niels Erdmann
Authorized Representative
Panasonic Testing Centre
Panasonic Marketing Europe GmbH
Winkelring 18, 22625 Hamburg, Germany

Serbian models

Hands-Free Telephone System

Panasonic

EU Declaration of Conformity
Document Number: PAS-300547-01

Manufacturer

Name : Panasonic Corporation
Address : 428 Hasegawa-cho, Tsuzuki-ku, Yokohama-shi, Kanagawa-ken, 224-8520, Japan

Object of Declaration < A >

Product Name : CARADDITION UNIT ASSY DAJ
Model Number : CL-WHSEAD, CL-WHSEAD, CL-WHSEAD, CL-WHSEAD, CL-WHSEAD
Model ID : AH2001
Type Number : same as Model Number

CE Requirements

This declaration of conformity is issued under the sole responsibility of manufacturer. The object of the declaration described above is in conformity with the requirements of the following EU legislation and harmonized standards:

Council Directive(s) : 2014/53/EU RED < B >

Applicable Standard(s) : EN 62368-1:2014 + A11:2017, EN 62311:2009, EN 301 489-1 V2.1.1:2017, EN 301 489-2 V2.1.1:2017, EN 301 489-3 V2.1.1:2017, EN 301 489-4 V2.1.1:2017, EN 300 328 V2.1.1:2016, EN 301 883 V2.1.1:2017, EN 300 440 V2.1.1:2017, EN 300 813 V1.1.1:2017 < C >

Notified Body
MCOB Ltd, Number 2290
Type Examination Certificate No. DEKRO28 / 4 Nov 2020 / Rev A

Additional Information < D >

2020/11/09 Date of Issue / Signature
Osamu Ishikawa / manager
Personal Name / Title

10.Nov.2020 Date of Issue / Signature
Wolfram Kühn
Authorized Representative
Panasonic Testing Centre
Panasonic Marketing Europe GmbH
Wiesbaden 15, 65133 Wiesbaden, Germany

Bluetooth Unit

KVALITET

Akcionarsko društvo za ispitivanje kvaliteta KVALITET NS
Акционарско друштво за испитивање квалитета ИСАКВИТЕТ ННС
Joint-stock company for quality testing KVALITET NS

ISO 9001
CERTIFIED
REGISTERED

POTVRDA O USAGLAŠENOSTI - RITTO
CONFIRMATION OF CONFORMITY - RITTO

Broj: P1620138300

Podnizalac zahteva: RITTO CONSULTING DOO
Applicant: 11590 BEOGRAD-RAKOVIČA
KNEŽA VIŠEŠLAVA, 632/2

Vrsta opreme: SISTEM ZA DALJINSKI PRISTUP VOZILU
Equipment category:

Omaka tip/modela: AJC775684
Equipment type/model:

Robna marka: Continental
Equipment trademark:
Proizvođač: Continental Automotive GmbH
Manufacturer: Germany

Vrednovana dokumentacija: Evaluated documentation:
Bebednost/Safety: TÜV SÜD Product Service GmbH, TR 04089-73497-01 (Edicija 02)
Isprava izveštaj: 23.04.2020/
Laboratory: SAKOEM, EMV TESTHAUS GmbH, 190050-AU02-E01, 66.11.2019/
Test report: RITTO/RITTO: EMV TESTHAUS GmbH, 190050-AU02-W01, 30.10.2019/

Nastavak primene u specifikaciji, opreme, komponentama, materijalnim delovima i drugim delovima koji ulaze na usaglašenost sa zahtevima. Further use in the specification, equipment, components of the design, electrical construction which may influence on conformity in the above-mentioned standards, material parts and other parts.

Na osnovu gornje navedene dokumentacije utvrđeno je da gornje navedena oprema zadovoljava zahtevne Tražilnicu o radio opremi i telekomunikacionoj terminalnoj opremi (SR, glavae RS, 11/2012).
On the basis of the above mentioned documentation it has been established that above mentioned equipment fulfills the requirements of the "Directive on Radio Equipment and Telecommunications Terminal Equipment" (Radio Equipment AS, 11/2012).

Mesto i datum ispitivanja: VAO DO, VAOI-001
Place and date: 08.09.2023

M.P. Seal:

Generisao izveštaj:

Ovaj dokument važi samo za proizvode koji su ispitivani sa procedurama koji su bili predmet vrednovanja.
This document is valid only for products that were tested with procedures that were the subject of the evaluation.
Bul. Svetog Duka Konstantina 62-68, 16000, Beograd, Srbija. Tel: +381-20-555 550-626, Fax: +381-20-555 550-626
e-mail: of@kvalitet.com.rs, info@kvalitet.com.rs

Ukrainian models

BCM
Keyless Access System



Postal address:
Siemensstrasse 12
D-93055 Regensburg
Germany
Manufacturer name:
Continental Automotive GmbH
Frequency band: 125KHZ
Maximum transmitted output: 10mW
Importer Name:
Pride Motor LLC
Postal address:
12, Sagaydachnogo Str., Kyiv,04070, Ukraine

ДЕКЛАРАЦІЯ ПРО ВІДПОВІДНІСТЬ

1. Радообладнання: Пристрій сервісного радіусу дії (примірні) 433 МГц, NFC.
тип, код, номер моделі чи серійний номер

2. ТОВ «Норвік»-Україна (офіс 314, вул. Крива 130, м. Мелітополь, Закарпатська обл., 72310, Україна, код ЄДРПОУ 37463168).
визначення та адреса виробника або особи, уповноваженої виробником

3. Ця декларація відповідності видає для об'єкту відповідальність виробника.

4. Об'єкт декларації:
Назва об'єкта: Модуль управління контрера автомобіля (Integrated Body Controller);
Модель: 41580430;
Торговельна марка: «Continental»;
Виробок: «Continental Automotive GmbH» (Siemensstrasse 12, D-93055 Regensburg, Germany) / «Континентал Аутомобіл ГмбХ» (Siemensstrasse 12, D-93055 Regensburg, Новагород),
Місце виробництва: «Continental Automotive Shanghai Co., Ltd.» (China Branch, 5800 Shanghai Street, 170000, Shanghai, Jilin P.R. China) / «Континентал Аутомобіл Чанчунь Ко., Лтд.» (China Branch, 5800 Шанхай Стріт, 130000, Чанчунь, Дзялінь П.Р. Китай), «CONTINENTAL AUTOMOTIVE GUADALAJARA MEXICO S DE RL DE CV» (Carretera a la Tierra No. 3, Km. 3.5 Carretera Guadalupe Morelia - Saloma la Tierra, 4540 Tlalcohuac de Zúñiga, Jalisco, Mexico) / «КОНТИНЕНТАЛ АУТОМОТІВ ГУАДАЛАГАРА МЕКСІКО С ДЕ РЛ ДЕ СВ» (Каньон 2 на Тієра №3, К.м. 3.5 Каррєра Гуадалупера Морєла, Колонія ла Тієра, 4540 Тіакохуак де Зунїга, Халіско, Мексика);
Номер моделі або серійний номер: призначення відповідальності сервісу.

5. Об'єкт декларації відповідає вимогам «Технічного регламенту радіобудівництва», затвердженого постановою Кабінету Міністрів України від 24.05.2017р. № 355



6. Стандарти з переліку національних стандартів, що були застосовані, та інші стандарти і технічні специфікації, щодо яких декларується відповідність:
з вимоги (вимоги в англіійській мові):
DSTU EN 62368-1:2017 (EN 62368-1:2014), AC 2011:426; AC 2015:02; AC 2015:11; AC 2017: A11-2017; IETC: IEC 62368-1:2014; MDD; CEN 12014; CEN 2:2015; IETD;
DSTU EN 62479-2015 (EN 62479:2010); IETD; EN 58663: 2017;
з національних стандартів (стандарт в англіійській мові):
DSTU EN 301 489-1:2014 (EN 301 489-1 V11.2, IETD);
DSTU ETSI EN 301 489-2:2009 (ETSI EN 301 489-2:2002, IETD);
об'єктом повільнозв'язного радіообладнання:
DSTU ETSI EN 300 220-2:2011 (ETSI EN 300 220-2:2017, IETD);
DSTU ETSI EN 300 220-1:2011 (ETSI EN 300 220-1:2017, IETD);
DSTU ETSI EN 300 330-2018 (ETSI EN 300 330:2017, IETD).

(з) міжнародних стандартизаційних номерів, перелік яких (лише англіійська)

7. Примірний орган з оцінки відповідності **ООП «Орган сертифікації «Центр сертифікації матеріалів на виробництво» (І.А. ПР-012)**
(назва/адреса, ідентифікаційний номер держави з реєстрації примірничого органу)
Висновки роботи з оцінки відповідності за примірною специфікацією типу (Модуль В)
(номер доповіді/номер дані)
та видає сертифікат відповідності типу № І.А.М.С.С. і Л.П.Р.-20 від 03 серпня 2020 р.
(з роз'ясненням акредитованого органу з оцінки відповідності)

8. Додаткова інформація:
Підписано від імені та за договором дорученням № 20180503 від 03.05.2018 р. «Continental Automotive GmbH» (Siemensstrasse 12, D-93055 Regensburg, Germany) уповноваженим представником в Україні ТОВ «Норвік»-Україна,
м. Мелітополь, Україна 03 серпня 2020 р.
(вказати повне ім'я)

Директор
ТОВ «Норвік»-Україна

Information

Ukrainian models

FOB
Keyless Access System



Postal address:
Siemensstrasse 12
D-93055 Regensburg
Germany
Manufacturer name:
Continental Automotive GmbH
Frequency band: 433.92MHz
Maximum transmitted output: 1mW
Importer Name:
Pride Motor LLC
Postal address:
12, Sagaydachnoho Str., Kyiv,04070, Ukraine

Information

ДЕКЛАРАЦІЯ ПРО ВІДПОВІДНІСТЬ

1. Радіоблокування: Пристрій короткого радіусу дії (433 MHz, RFID (пасивний), *карт, ключ, пульт дистанційного керування*)

2. ТОВ «Норком-Україна» (офіс: 314, вул. Кірова 139, м. Мелітополь, Запорізька обл., 72319, Україна, код ЄДРПОУ: 37461166).

(назва/позначення на адресу виробника або його уповноваженого представника)

3. Ця декларація відповідності видає під особисту відповідальність виробника

4. Об'єкт декларції:
Назва радіоблокування: **Високо потужний (Radio Frequency Transmitter / Honda MY21):**
Модель: **TR_4**
Торговельна марка: **«Самітонт»;**
Виробник: **«Continental Automotive GmbH»** (Stromstraße 12, D-93055 Regensburg, Germany) / **«Континентал Аутомотів ГмбХ»** (Siemensstrasse 12, D-93055 Regensburg, Носеніталь) / **«Continental Automotive Shamsan Co., Ltd.»** (Планета Бітліш, 2800 Shamsan Street, 130000, Shanghai, Jilin P.R. China) / **«Континентал Аутомотів Манчжун Ко., Трей»** (Гуанчжоу Кросс, 2800 Шенгань Стріт, 330000, Чанчжоу, Манчжоу, Дзянші П.Р. Китай); **«CONTINENTAL AUTOMOTIVE GLOBALAJARA MEXICO S DE RL DE CV»** (Camino a la Tierra No. 3, Km. 3.5 Colonia Oaxaca, 68000, Mexico Colonia de Tierra, 45640 Tlaximilco de Zampar, Jalisco, Mexico) / **«CONTINENTAL AUTOMOTIVE GUADALAJARA MEXICO S DE RL DE CV»** (Carretera a la Tierra No. 3, Km. 3.5 Carretera Guadalajara-Morelia, Jalisco de Mexico, 46040 Tlaximilco de Zampar, Jalisco, Mexico); **«Норком Україна»** або **«Україна»** (адреса: м. Київ, Хмельницька, Мелітополь) *(назва/позначення на адресу виробника або його уповноваженого представника)*

5. Об'єкт декларції відповідає вимогам «Технічного регламенту радіоблокування», затвердженого постановою Кабінету Міністрів України від 24.05.2017р. № 355.

6. Стандарти з переліку національних стандартів, що були застосовані, та інші стандарти і технічні специфікації, щодо яких декларується відповідність:
з Кодексу Європи (Європейське радіоблокування):
DCTU EN 62368-1:2017 (EN 62368-1:2014, AC:2015-05, AC:2015-02, AC:2015-11, AC:2017, A11:2017, IDT, IEC:62368-1:2014, MCOF:EN 62368-1:2014, IEC:7:2014, ITRU, DCTU EN 62479:2015 (EN 62479:2010, IDT), EN 56663: 2017, з міжнародними стандартами Європи з повільного радіоблокування):
DCTU EN 301 489-1:2014 (EN 301 489-1 V1.9.2, IDT), DCTU EN 301 489-3:2009 (ETSI EN 301 489-3:2002, IDT), оформлені на національному радіоблокувальному ресурсі (примов.) *(національний регламент):*
DCTU ETSI EN 300 228-2:2017 (ETSI EN 300 228-2:2017, IDT), DCTU ETSI EN 300 228-1:2016 (ETSI EN 300 228-1:2017, IDT), DCTU ETSI EN 300 330:2017 (ETSI EN 300 330:2017, IDT).
(з національних специфікаційних нормативів, адреси посилаючись)

7. Презентований орган з огляду відповідності **FOB «Орган сертифікації «Центр сертифікації патентів та промислових (SI 114, TR.62)**

(назва/позначення спеціалізованої компанії з огляду з розширенням юридичного статусу)

Виконав роботи з огляду відповідності за параметрами електричної тишії (Модель В) *(дата/назва/позначення чл. 58)*

та виконав сертифікат експертизи типу № UA.032.CT.0219-20 від 02 червня 2020 р. *(у разі зазначення професійного органу з огляду відповідності)*

8. Додаткова інформація: Процедура версія 04/0.

Підписав на ім'я та на адресу виробника № 20180502 від 02.05.2018 р. «Continental Automotive GmbH» (Stromstraße 12, D-93055 Regensburg, Germany) уповноваженого представником в Україні ТОВ «Норком-Україна»:
м. Мелітополь, Україна
(підпис та дата видання)

01 червня 2020 р.

Директор
ТОВ «Норком-Україна»:

О. В. Штегерін
ТОВ «Норком-Україна»
UA-032-01_0014-1-00
Дата: 02.05.2020

Ukrainian models

CARD
Keyless Access System



Postal address:
45-29, SaEum-Road, Icheon-City, Gyeonggi-do, Korea
Manufacturer name:
Continental Automotive Systems Corporation
Frequency band: 433.92MHz
Maximum transmitted output: 1mW
Importer Name:
Pride Motor LLC
Postal address:
12, Sagaydachnogo Str., Kyiv,04070, Ukraine

ДЕКЛАРАЦІЯ ПРО ВІДПОВІДНІСТЬ

1. Радіообладнання: SV1-HOCFGE00.
2. Найменування та адреса виробника: «Continental Automotive Systems Corporation» (45-29, SaEum-ro, Icheon-si, Gyeonggi-do, 17308 Korea) / «Компанія Автомобільні Системи Континенталь» (45-29, Саєум-ро, Ічєон-сі, Гьєонґґі-до, 17308 Корея).
3. Ця декларація відповідності видає під особисту відповідальність виробника.
4. Об'єкт декларації: Радіообладнання (CARD ASSY ENTRY KEY) моделі SV1-HOCFGE00 системи Ассистент до автомобіля в.м. «HONDA».
5. Об'єкт декларації відповідає вимогам таких технічних регламентів:
Технічного регламенту радіообладнання, затвердженого Постановою Кабінету Міністрів України від 24 травня 2017 р. №355.
6. Посилання на відомі стандарти з переліку національних стандартів, що були застосовані, або посилання на інші технічні специфікації, щодо яких декларується відповідність:
ДСТУ EN 62368-1:2017 (EN 62368-1:2014; AC:2015-05; AC:2015-02; AC:2015-11; AC:2017; A1:2017; IDT); IEC 62368-1:2014, MOD; Csr 1:2014; Csr 2:2011, IDT;
ДСТУ EN 62479:2015 (EN 62479:2010, IDT);
ДСТУ ETSI EN 301 489-1 V1.9.2:2014 (EN 301 489-1 V1.9.2, IDT);
ETSI EN 301 489-1 V2.1.1 (2017-02); ETSI EN 301 489-1 V2.1.1 (2017-03);
ДСТУ ETSI EN 300 336:2018 (ETSI EN 300 336:2017, IDT);
ДСТУ ETSI EN 300 220-2:2017 (ETSI EN 300 220-2:2017, IDT);
ДСТУ ETSI EN 300 220-1:2018 (ETSI EN 300 220-1:2017, IDT).

7. Позначений сегмент з ознаки відповідності
OOB «OMEGA» TOB «BII» «OMEGA» MUA.TR.109
(Позначення, ідентифікаційний номер моделі з розширенням країни)

Виконав: офіційну відповідність за процедурою експертизи нових (модель B) Технічного регламенту радіообладнання та видав сертифікат експертизи типу: MUA.TR.109.R.0265-29 від 19.08.2020 р.

8. У відомостях наведена список компонентів та асесорії, у тому числі програмного забезпечення, завдяки якому радіообладнання функціонує за призначенням і на яке поширюється дія декларації про відповідність: SW: 1.0.

9. Додаткова інформація: Радіообладнання (CARD ASSY ENTRY KEY) моделі SV1-HOCFGE00 системи Ассистент до автомобіля в.м. «HONDA», що використовується «Continental Automotive Systems Corporation» (45-29, SaEum-ro, Icheon-si, Gyeonggi-do, 17308 Korea) / «Компанія Автомобільні Системи Континенталь» (45-29, Саєум-ро, Ічєон-сі, Гьєонґґі-до, 17308 Корея).

Підписано від імені виробника уповноваженим представником ГОВ «Радіо Тест Стандарти» (Україна, 03115, м. Київ, вул. Львівська, б. 22А, к. 135, код ЄПРДЮУ 39205151).

м. Київ, Україна 19 серпня 2020 р.

Директор Д.В. Шумов

Information

Ukrainian models

Hands-Free Telephone System

<https://service.panasonic.ua/>

справжнім Panasonic Corporation заявляє, що тип радіообладнання AH2001 відповідає Технічному регламенту радіообладнання; повний текст декларації про відповідність доступний на веб-сайті за такою адресою: <https://service.panasonic.ua/> (розділ «Технічне регулювання») моделі; [AH2001]

Postal address:

4261 Ikonobe-cho, Tsuzuki-ku, Yokohama City, 224-8520, Japan
 Manufacturer name:

Panasonic Corporation

Operational frequency band:

Specifications of Bluetooth
 Frequency band: 2402-2480MHz

Specifications of 2.4GHz WLAN

Frequency band: 2412-2472MHz

Maximum Output Power:

Specifications of Bluetooth

Maximum output power: 0.1dBm

Specifications of 2.4GHz WLAN

Maximum output power: 11.9dBm

Importer Name:

Pride Motor LLC

Postal address:

12, Sagaydachnoho Str., Kyiv,04070, Ukraine

ДЕКЛАРАЦІЯ ПРО ВІДПОВІДНІСТЬ Panasonic Corporation AH2001

- Автономний аудіоприспій з дисплеєм (UNIT ASSY DA) т.м. Panasonic Corporation моделі AH2001 з обладнанням радіодоступу (інтерфейс передачі даних IEEE 802.11 a/b/g/n/ac, IEEE 802.15.1 Bluetooth) та GPS-приймачем.
Роздільні частини (серія, тип, номер партії та серійний номер)
- Уповноважений представник виробника - ТОВ «Радіо Тест Стандарти» (03115, м. Київ, вул. Лаврської, 22А, к. 135, ЄДРПОУ 30252151) діє за дорученням "Panasonic Corporation", 4261 Ikonobe-cho, Tsuzuki-ku, Yokohama-shi, Kanagawa-ken 224-8520, Japan / Японія від 30.01.2018.
Найменування та адреса виробника або його уповноваженого представника
- Ця декларація відповідності видана під особистою відповідальністю виробника.
Об'єкт декларації (оформлення об'єкта декларації для ідентифікації):
Об'єкт декларації (ідентифікатор радіобудованих, на дані якого складається база промислових, інших виробничих каталогів чи реєстрів) та/або ідентифікатор радіобудованих



- Об'єкт декларації відповідає вимогам Технічного регламенту радіобудованих, затвердженого постановою КМ України від 24.05.2017 № 355.
- Об'єкт декларації відповідає вимогам наступних НД:
 ДСТУ EN 60959:2017, ІЕС 60068-2:04, ДСТУ EN 60068:2017, EN 60068-2:04 (High Voltage), ДСТУ EN 62111:2014, ДСТУ EN 301 488-1:2014, ETSI EN 301 488-1 V2.1.1 (2017-02), ДСТУ ETSI EN 301 488-3:2009, Final Draft ETSI EN 301 488-3 V2.1.1 (2017-04), ETSI EN 301 488-1:2014, ETSI EN 301 488-1 V2.1.1 (2017-02), ДСТУ ETSI EN 301 488-3:2008, ETSI EN 301 488-1 V2.1.1 (2017-02), ДСТУ EN 301 488-3:2004, ETSI EN 301 488-1 V2.1.1 (2017-02), ДСТУ ETSI EN 301 488-15:2008, Draft ETSI EN 301 488-19 V2.1.0 (2017-03), ДСТУ EN 55032:2017, EN 55032:2015 = AS:2016, Class A, EN 55035:2017, ДСТУ ETSI EN 301 893:2017, ETSI EN 301 893 V2.1.1 (2017-04), ДСТУ ETSI EN 300 320:2007, ETSI EN 300 320 V2.1.1 (2016-11), ДСТУ ETSI EN 300 340-2:2004, ETSI EN 300 340 V2.1.1 (2017-03), ETSI EN 300 419 V1.1.1 (2017-06).
Позначення на етикетці стандарту з номером, якщо він є, та/або, якщо було встановлено, або розроблено на базі технічних специфікацій, якщо такі специфікації наведено в зазначеному додатковий номер, моделі та дати видання
- Присвоєний органів в сфері відповідності:
 ООВ УМЧАСТОТНАГЛРД, 03179, м. Київ, пр-т Перемоги, 151, реєстр. номер ЦА.78.052 за наказом Міністерства розвитку України від 11.04.2018 № 500
Ідентифікатор, сертифікаційний номер органу з метою перевірки легітимності

власник добровільно оцінює відповідність зовнішнього проекту радіобудованих пристроїв вимогам Технічного регламенту радіобудованих, затвердженого постановою КМ України від 24.05.2017 № 355 за процедурою експертизи типу (модель B) та видає сертифікат (сертифікаційний номер ЦА.78.052 381-19 від 24 травня 2019 р.



Information

Ukrainian models

Hands-Free Telephone System

8. Програмне забезпечення встановлюється. Не встановлюється.

9. Кардифон встановлюється окремою системою та встановлює, у тому числі програмне забезпечення, необхідне для роботи ідентифікаційних функцій та програмованих на них параметрів та даних для ідентифікації.

9. Додаткова інформація:

Виробник – «Панасонік Корпорейшн», Японія, 4161 Косе-но-4, Торуї-ку, Ямагучі-ші, Кагасані-ші 224-8220 (Японія: Сопейшіт), 4153 Ямагучі-ші, Тсукуба-ші, Цубіката-ші, Кагасані-ші 224-8530, Японія) на підприємстві: 1) «Панасонік Автомобільні Системи де Мексика С.А.С.», де С.У. Сантафіа Район де Мексика 3211 5/9, Parque Industrial Region de Mexico, Toluca, C.P. 88760, Мексика; 2) «Панасонік Автомобільні Системи, Дарлінг-ші, (Інд.)», Індія, (Panasonic Automotive Systems Darling Sh., Ltd.), No.300, Honegar Road, Gurgaon District Gurgaon City, Haryana Pradesh, 136013 P.O. (India); 3) «Панасонік Автомобільні Системи Азія Південь Ро., Лід., Таїланд», (Panasonic Automotive Systems Asia Pacific Co., Ltd.), 102, M-2, Pongphit Rd., 1- Bangrak District, Bangkok Bangkok, Samyatharun 10550, Thailand; 4) «Панасонік До Бразилія Фінанція Руні Матрікс'а», Бразилія, (Panasonic do Brasil Ltda da Rua Matriz), 1155 - Distrito Industrial 03075-150 -Mauá - SP (Brazil); 5) «Панасонік Корпорейшн Автомобільні Системи Фінанція Сінгапур», Малайзія, (Panasonic Automotive Systems (Singapore) Pte. Ltd.), 1101, Upper Cross Street, Singapore; 6) «Панасонік Автомобільні Системи Чехія, с.р.о.», Чехія, (Panasonic Automotive Systems Czech, s.r.o.), U Prazskeho 246, Stará Čáslav 33006 Hrabuvice Czech Republic; 7) «Панасонік Тайвань Ко., Лід., Тайвань», (Panasonic Taiwan Co., Ltd.), Car Electronics Division, R&D Technology Domain Business 679, Yuan Shan Road, Chung Ho Street, New Taipei City, Taiwan; 8) «Панасонік Автомобільні Системи Малайзія», (Panasonic Automotive Systems), Malaysia Sdn. Bhd. Plot 10, Phase 4, Free Industrial Estate, 13000 Prai Penang, Malaysia;

10. Підписано ТОВ "Радіо Тест Стандарт", 00115, м. Київ, вул. Львівська, 22А, к. 135, ЄДРПОУ 32095151 від імені та за дорученням "Panasonic Corporation", Японія, від 30.01.2018.

11. Наступні надрукування стосуються видавничого продукту:

Шуман Д.В.
Директор ТОВ "Радіо Тест Стандарт"
 Бровари, м.к.ч. по Близькі, (с.п.д.)

Делегація кола
 на об'єкт: **ОВ УМЧАСТПНАГРД**
 02729 м. Київ, пр.П. Лермонтов 351, каб. 138 (044) 422-85-44
 UA 18.492

Об'єктовий номер: **Дізн про односторонню РВ УМЧ-ЕВЧ-344 від 24.05.2019**
 (відомо для заповнення протоколу прийняття рішення при наданні дозвільних дій)

Керівник
ОВ УМЧАСТПНАГРД
 М.П.  **О.Г. Пosenko**

Місцевість, директор(и) тільки переказати в Лаві разом ООВ УМЧАСТПНАГРД на www.rts.gov.ua
 Делегація кола на об'єкт ООВ УМЧАСТПНАГРД за адресою: м. Бровари

Information

Ukrainian models

Telematics Control Unit



модель: OGEY10

смуга радіочастот:

GSM900 (Rx: від 925 до 960 МГц)

GSM1800 (Rx: від 1805 до 1880 МГц)

WCDMA Band1 (Rx: від 2110 до 2170 МГц)

WCDMA Band3 (Rx: від 1805 до 1880 МГц)

WCDMA Band8 (Rx: від 925 до 960 МГц)

LTE Band1 (Rx: від 2110 до 2170 МГц)

LTE Band3 (Rx: від 1805 до 1880 МГц)

LTE Band7 (Rx: від 2620 до 2690 МГц)

LTE Band8 (Rx: від 925 до 960 МГц)

LTE Band20 (Rx: від 791 до 821 МГц)

GPS/GALILEO/EGNOS (Rx: 1575.42 МГц)

виробник: DENSO CORPORATION

адреса: 1-1, Showa-cho, Kariya-shi, Aichi-ken, 448-8661 Japan

Імпортер: Pride Motor LLC

адреса: 12, Sagaydachnogo Str., Kyiv, 04070, Ukraine

справжнім DENSO CORPORATION заявляє, що тип радіообладнання відповідає Технічному регламенту радіообладнання;

повний текст декларації про відповідність доступний на веб-сайті за такою адресою:

<https://www.denso.com/global/en/contact-us/doc/>

Ukrainian models

Blind spot information System*/Cross Traffic Monitor*

Postal address:
 26545 American Drive Southfield, Michigan, 48034 United States of America
 Manufacturer name:
 Veoneer US, Inc.
 Operational frequency band:
 24.125 GHz
 Maximum Output Power:
 13dbm
 Importer Name:
 Pride Motor LLC
 Postal address:
 12, Sagaydachnogo Str., Kyiv,04070, Ukraine



Information

* Not available on all models

Ukrainian models

Wireless Charger*



ДОДАТОК
до сертифіката експертизи типу
ANNEX TO TYPE EVALUATION CERTIFICATE

№ UA.032.CT.0228-20 від 10 червня 2020 р.

1. Обґрунтування відповідності пристрою вимогам Технічного регламенту радіодобудовки, протоколів, пов'язаних документації

Сутьна вимога ТР	Вимога, що перевіряється	Протоколи	Дата	Стандарти, що застосовувалися
п. 8 абз. 1	Безпечна	384101	02.04.2020 р.	ДСТУ EN 62368-1:2017 EN 62368-1:2014, AC:2015-05, AC:2015-02, AC:2015-11, AC:2017, A11:2017, IKT; IEC 62368-1:2014, MOD, Clauses 1:2014, Clauses 2:2015, IKT
	SAR	ENTCSET3003-0118	20.03.2020 р.	ДСТУ EN 62311:2014 EN 62311:2008, IKT
п. 8 абз. 2	EMC	ENECSET1909-0332(1)	03.03.2020 р.	ДСТУ EN 55014:2014 EN 55014:2011, V1.9.2, IKT); ДСТУ EN 55014:2010 (EN 55014:2010, IKT)
	WPT	ENKCKSET1908-0332(1)	28.02.2020 р.	EN 62311:2014 EN 62311:2008, IKT)
п. 6	Відсутні нормативно-правові акти, що визначають категорію або клас радіодобудовки на якому розповсюджується величина цього параметру.			

2. Технічні характеристики радіодобудовки.

2.1 WPT

2.1.1 Діапазон частот: 90-119 МГц

2.1.2 Робоча частота: 110,89 МГц

2.1.3 Нормування шкідливого поля передавача на відстані 10 м, не більше: міліус 2,75 дБмкВ/м

2.1.4 Тип антени: загнута антена.

3. Програмна версія 3.7.

4. Перелік документів на продукцію, що розробляється:

Специфікація Польових користувачів; Маркування; Схеми; Плати; Описки ревізії; Збірники та коментарії; Декларація ЕУ.

5. Умови застосування.

Продукція відповідає вимогам відповідних умов зазначених у пункті 4.65, як схваленої Рішенням МРЗП від 12.01.2012 №189 стисне на 28.04.2020 р.

Експлуатація зазначеного в цьому сертифікаті радіодобудовки в зазначеному складі та певних параметрах здійснюється на базовій частоті (Рішення МРЗП №44 від 25.12.2014 р. введено в дію) Міністерства юстиції України 19.02.2015 р. за № 201202646, з урахуванням його доповнення про порядок і форми оформлення рішень про радіодобудовку, зокрема на підприємстві, пристрої, що мають застосовуватися на території України і сигнал радіочастот загальної користування, затвердженого рішенням МРЗП 03.04.2018 р. за № 184, затвердженого Міністерством Юстиції України 07.06.2018р. за № 88023145.



Керівник органу державної експертизи
Володимир КИРИЛЕНКО

О. С. Іваненко

Ім'я, прізвище, по батькові
(Україна, Молдова, Республіка Польща)

Ukrainian models

Bluetooth Unit

Manufacturer name:
 Continental Automotive GmbH
 Postal address:
 Siemensstraße 12, D-93055 Regensburg, Germany
 BLE frequency range:
 2.402GHz to 2.48GHz
 BLE Maximum Output Power:
 +20dBm
 Importer Name:
 Pride Motor LLC
 Postal address:
 12, Sagaydachnogo Str., Kyiv,04070, Ukraine

ДЕКЛАРАЦІЯ ПРО ВІДПОВІДНІСТЬ

1. Радіообладнання: **Bluetooth (BLE) Std 182.15.1.**
Видаток згідно з пунктом 1 статті 14 Закону

2. ТОВ «Наріаком-Україна», **с/д/с** МІА, вул. Кривої 139, м. Миколаївка, Ізюмська обл., 72319, Україна; код ЄДРПОУ: 37663164.
Ідентифікатор, який призначає для відповідального особи виробника

3. На декларовані відомостях надають відомості про відповідність виробника.

4. Об'єкт декларації:
 Власне обладнання: система доступу до транспортних засобів (Smart Keys ECU), Адаптер: АСХ775664.
 Виробничий номер: «CONTINENTAL»
 Торговельний марку: «CONTINENTAL»
 Виробничий завод: «В-16 Виробничий завод»
 Адреса: «Continental Automotive GmbH (Siemensstraße 12, D-93055 Regensburg, Germany) / «Континентал Автомобілс ГмбХ (Siemensstraße 12, D-93055 Regensburg, Deutschland)»
 Адреса імпортера: «Pride Automotive (P.R.L.) Ltd» (Bavskaya Road, FT Special Economic Zone, Ebury, City, 1630, Paphos) / «Трем Аут-омобіл (Фіс.с.т.) Інв.» (Бавська зона ФТІАВ-Спеціал. Економіч. Зона, Тербі Ситі, Кіпріос)»
 Декларувач гарантує справність даних, згідно з якою виготовляється сервіс.
Ідентифікатор відповідальності: місце виробництва відповідного виробника

5. Об'єкт декларації відповідає вимогам «Технічного регламенту радіобудівництва, затвердженого постановою Кабінету Міністрів України від 24.05.2017р. № 355».

6. Стандарти з переліку національних стандартів, які були затверджені, та інші стандарти і технічні специфікації, щодо яких декларувач відповідає:
 з переліку вимог з відповідності (вимог):
 ДСТУ EN 62288-1:2017 (EN 62288-1:2014, AC: 2013-05, AC: 2015-02, AC: 2015-11, AC: 2017, A11:2017, B11),
 IEC 62288-1:2014, MOD, Сир 1:2014, Сир 2: 2013, B11),
 з переліку національних стандартів (вимог):
 ДСТУ EN 301 489-1:2014 (EN 301 489-1 V1.2, B11),
 ДСТУ ETSI EN 301 489-1:2008 (ETSI EN 301 489-1:2008, B11),
 державного підприємства «Радіотехнічний центр України» (національний стандарт)
 ДСТУ ETSI EN 300 328:2017 (ETSI EN 300 328:2016, B11).

7. Присвоєний орган з оцінки відповідності **ДОВ «Сфера сервіс/фізпідприємство «Метрум сервіс/фізпідприємство імпортерів та виробників» (ЄДРПОУ 37663164)**
Ідентифікатор органу відповідності згідно з пунктом 1 статті 14 Закону
 Видана робота з оцінки відповідності за проведеною експертизою типу (Модель В)
Ідентифікатор експертизи згідно з пунктом 1 статті 14 Закону
 та видав сертифікат оцінки типу, № 1 (А-832.С.Т.0361-20 від 03 вересня 2020 р.
Ідентифікатор експертизи згідно з пунктом 1 статті 14 Закону

8. Додаткова інформація: **присвоєна версія – V6.15.**
 Підписано від імені та за Дирекцією № Б/І від 04.03.2020 р. «Continental Automotive GmbH» (Німеччина), уповноваженою представителем в Україні – ТОВ «Наріаком-Україна» (Україна).
 м. Миколаїв, Україна 03 вересня 2020 р.

Директор ТОВ «Наріаком-Україна»   **Шквеса Ольга Володимирівна**
Ідентифікатор відповідальності: місце виробництва відповідного виробника
 м.п.  **Влада на збілку**
 ТОВ «СІС» (ЄДРПОУ № 38019020)
 16.030 п. **СІС/ІТ/СІС**
 дата: **03.09.2020**

Information

Ukrainian models

Remote Tuner

справжнім Panasonic Corporation заявляє, що тип радіообладнання * відповідає Технічному регламенту радіообладнання;

повний текст декларації про відповідність доступний на веб-сайті за такою адресою:

<https://service.panasonic.ua/>

(розділ «Технічне регулювання»)

моделі; [*]

CQ-TH4BE0AJ

Об'єкт декларації відповідає вимогам Технічного регламенту радіообладнання, затвердженого постановою КМ України від 24.05.2017 № 355

Назва виробника: Panasonic Corporation

Поштова адреса: 4261 Іконобе-чо, Цузуки-ку, Йокогама-ши, Канагава-кен, 224-8520, Японія

Importer Name:

Pride Motor LLC

Postal address:

12, Sagaydachnoho Str., Kyiv, 04070, Ukraine

ДЕКЛАРАЦІЯ ПРО ВІДПОВІДНІСТЬ

Радіообладнання: **AMF3UDJW** (тип, код, маркування чи серійний номер)

2. **ТОВ «ЛІГІТА УКРАЇНА»** (Україна, 04050, м. Київ, Шевченківський район, вул. Куря Лазаря, будинок 12, код ЄДРПОУ 36384409).

3. **На декларовані відомої моделі немає особливих відмінностей порівняно:**

4. Об'єкт декларації:

Модель обладнання: автоматизована.
 Торговельна марка: «Panasonic».
 Моделі: CQ-TH2BE0AJ, CQ-TH3BE0AJ, CQ-TH4BE0AJ, CQ-TH5BE0AJ.
 Бренд виробника: «В. Ямаха» з Японії та Китаю.
 Виробник: «Panasonic Corporation» (4261, Іконобе-чо, Цузукі-ку, Йокогама-ші, Канагава-кен, 224-8520, Японія) / «Panasonic Corporation» (4261, Іконобе-чо, Цузукі-ку, Йокогама-ші, Канагава-кен, 224-8520, Японія).
 Адреса виробника: «Panasonic Corporation Matsuyama Site» (5652, Осака Савага, Матсуйока-ші, Нагано-кен, 394-8726, Японія) / «Panasonic Corporation Malaysia Cyber 15652, Data Center, Makmurah, 11, Nagasari, 709 E1/9, Janda, «Panasonic Automotive Systems Datab Co., Ltd.» (No.190, Hongkong Road, Guangzhou, United States City, Liaoning Province 116033, P.R. China) / «Panasonic Automotive Systems Datab Co., Ltd.» (No.300, Xuyi Road, Guangzhou, Dapeng City, Liaoning Province 116033, China).
 Інформація про серійний номер: присутня на готовості серіїв.

5. Об'єкт декларації відповідає вимогам «Технічного регламенту радіообладнання, затвердженого постановою Кабінету Міністрів України від 24.05.2017 р. № 355».

6. Стандарти з переліку національних стандартів, що були застосовані, та інші стандарти і технічні специфікації, щодо яких здійснюється відповідність:

а) Базові вимоги до радіочастотного регулювання:
 ДСТУ EN 62108-1:2014 (EN 6368-1:2014; AC:2014-05; AC:2015-02; AC:2015-11; AC:2017-07; A11:2017); IDT;
 IEC 62368-1:2014; MDD; CEN 12014; CEN 2:2015; IDT;
 б) Інформаційні специфікації з функцій і технічних характеристик:
 ДСТУ EN 55032:2017 (EN 55032:2015; IDT);
 ДСТУ EN 55035:2017 (EN 55035:2017; IDT); CISPR 32:2014; MDD;
 «Базові технічні вимоги до радіочастотного регулювання і відповідних технологій»
 ETSI EN 302 245 V1.1.7 (2011/07)

7. Присутній пункт з однієї зі статистичних таблиць «Відомості про серійні номери» та інші статистичні дані про серію (EN 62108-1:2014).

8. Додаткова інформація:
 Підписано цю заяву та за ДОГОВОРОМ ДОПУЩЕННЯ № 21266418 від 18.06.2018 р. «Panasonic Corporation» (Японія), уповноваженою представником в Україні – ТОВ «ЛІГІТА УКРАЇНА» (Україна).

м. Київ, Україна 29 вересня 2018 р.

Директор ТОВ «ЛІГІТА УКРАЇНА» Кривонос Євген Євгенович

М.П. 

Ваша копія
 ТОВ «ЛІГІТА УКРАЇНА»
 UA 012 0 80497 000
 0172 00 000 0000

Moldova models

BCM Keyless Access System

Intended use:
Short range device for remote control
Postal address:
Siemensstrasse 12
D-93055 Regensburg
Germany
Manufacturer name:
Continental Automotive GmbH
Frequency band: 125KHz
Maximum transmitted output: 10mW
Importer Name:
Honda Motor Europe Ltd - Aalst Office
Postal address:
Wijngaardveld 1 (Noord V) 9300 Aalst - Belgium

MINISTERUL ECONOMIEI ȘI INFRASTRUCTURII AL REPUBLICII MOLDOVA Serviciu Public, SERVICIUL NAȚIONAL DE MANAGEMENT AL FRECVENȚELOR RADIO	
CERTIFICAT DE CONFORMITATE	
Nr. de înregistrare: MD OC TIP 024 A6871-20 Data emiterii: 24 august 2020 Valabil până la: 24 august 2023	
ORGANISMUL DE CERTIFICARE: OC/pr - 024	
Organismul de Certificare a producător de Telecomunicații, Informatică și Poștă (OC TIP)	
MD-2003, str. Nicolae Druș, nr. 22/20, nr. Districtul mun. Chișinău, tel./fax: (+373) 22 783750 / 783727	
PREZENTUL DOCUMENT SE CONFIRMĂ FAȘTUL CĂ PRODUSUL IDENTIFICAT ÎN ACESTUL	
DENUMIRE / DESCRIEREA	
Descriere: Mobil radio de control pentru sisteme de acces și porțile al autochiracității imobiliare	Codul NCM 8531
Marca comercială: Continental Model: 41580450	
Fabricat în serie	
SÎNTE CONFORME CU CERINȚELE FURNICATORILOR STAȚIUNILOR:	
ERECORD "8000" An 1 și 0; SM EN 300 225 și V2.4.1.2015; SM EN 301 488-1 V1.9.2.2014; SM EN 59012:2016; SM EN 6268-1:2015; RT "Schișagentele radio, echipamentele terminale de telecomunicații și reconstituirea conformității acestora", aprobată prin HG nr. 1274 din 22.11.2007; RT "Parametri tehnici de emisie și dispozitive cu rațiunea de acțiune", aprobată prin hotărâre MTIC nr. 16 din 21.02.2014.	
PRODUCĂTOR	
1. Continental Automotive Changsha Co., Ltd., Jingyu Branch 5800 Shanghai Street, 109000, Changsha, Hun, China 2. Continental Automotive Guadalajara Mexico S de RL de CV Carretera a la Tierra No. 3, Km. 3.5 Carretera Guadalajara Mexico, Colonia la Tierra, 45040 Tijuana de Zaragoza, Jalisco, Mexico	
SOLICITANT	
Continental Automotive GmbH, Siemensstrasse 12, 93055 Regensburg, Germany	
CERTIFICATUL AȘTUIAȘI ELIBERAT ÎN RAȚA	
Rețeaua de înregistrare: T2003/04/01/02 din 10.06.2020 nr. T2003/04/01/01/01 din 11.06.2020; nr. T2003/04/01/01/02 din 16.06.2020 nr. T2003/04/01/01/03 din 07.07.2020 nr. T2003/04/01/01/04 din 14.07.2020, eliberate de LJ "Comisia de Certificare Servicii Inc. Waga Laboratory" Timpul acordat: "14.7" - nr. 120.	
Certificat a licenței de funcționare SA TP 14849:2010 din 09.03.2016 (SA TP nr. 020204) de la ECRN - eliberat de "CRS Holding GmbH Germany" Certificat a licenței de funcționare SA TP 1999:2010 nr. 0111402709/03 (SA TP nr. 0314339) din 04.05.2010, eliberat de "TVS Standard Cert GmbH Germany" Declarația de conformitate a producătorului din 16.07.2020. Raport de evaluare din nr. 224/20 din 22.08.2020.	
INFORMAȚII SUPLEMENTARE	
Valabilitatea certificatului de conformitate se bazează pe verificarea conformității produsului cu cerințele tehnice aplicabile. Acest document de conformitate este un produs al implicării autorității naționale de certificare. Certificatul poate fi utilizat în baza de înregistrare 156-04 KHz și 6000-64,70 MHz. Grup de lucru: Moldova FI	
Conducătorul organismului de certificare	
Anotimp: GUJUN	
Acest certificat de conformitate se legitimează de către OC TIP - Seria A - Nr. 002294	

Moldova models

FOB
Keyless Access System

Intended use:
Short range device for remote control
Postal address:
Siemensstrasse 12
D-93055 Regensburg
Germany
Manufacturer name:
Continental Automotive GmbH
Frequency band: 433.92MHz
Maximum transmitted output: 1mW
Importer Name:
Honda Motor Europe Ltd - Aalst Office
Postal address:
Wijngaardveld 1 (Noord V) 9300 Aalst - Belgium

MINISTERUL ECONOMIEI ȘI ÎNTRĂRII STRUCTURILOR AL REPUBLICII MOLDOVA
Biroul Național de Standardizare și Management al Frecvențelor Radio

CERTIFICAT DE CONFORMITATE

Nr. de înregistrare: **MD OC TIP 024 A6846-20**
Data emiterii: 17 august 2020 Valabil până la: 17 august 2023

ORGANISMUL DE CERTIFICARE: OC/pr-024

Organismul de Certificare a produselor din Telecomunicații Informații și Poști (OC TIP) MD-2003, str. Nicolae Dabija, nr. 22/20, et. Dabijași, sector Chișinău, tel./fax (+373 22) 785730 / 785727
REVIZIUNEA DOCUMENTULUI DE CONFORMITATE CU PRODUSELE IDENTIFICATE AȘTEI
DENUMIRE: ÎNSURȘIREA

Descriere: **Emițător radio, Honda MY21, pentru sistemul de acces și pentru al autovehiculului**

Marca comercială: **Continental** Codul NCM: **8531**

Model: **TP_4**

Fabricate în serie
SUNT CONFORME CU CATEGORIILE DE CLASIFICARE STABILITE ÎN:
ENEC REC 19-01, Art. 1 și 9, SM EN 301 485-1 V.1.0, 2014; SM EN 300 220-1 V2.4.1:2015;
SM EN 62368-1:2015; ET "Tehnologia radio, echipamente terminale de telecomunicații și dispozitive de comunicații accesoria", aprobat prin HO nr 579 din 23.11.2007; ET "Parametri tehnici de emisie ai dispozitivelor cu un nivel mic de aprindere", aprobat prin Ordinul MTC nr. 16 din 21.02.2014.

PRODUCĂTOR
1. Continental Automotive (Chengshan) Co., Ltd., Jiangxi Branch
5800 Shengqian Street, 330000, Chengshan, Jiu, China
2. Continental Automotive (Dundalk) Mexico S. de RL de CV,
Carretera a la Tijera No. 3, K.m. 3.5 Carretera Quetzalajars Morelia, Colonia la Tijera,
45640 Tijuana de Zaragoza, Jalisco, Mexico

CONȚINĂTOR
Continental Automotive GmbH,
Siemensstrasse 12, D-93055 Regensburg, Germany

CENTRUL ATĂTĂȘTEȘTERIBERAT ÎN BULGARIA
- Raport de conformitate T200419W-RT nr. T200419W-RT nr. T200419W-AC nr. T200419W-RE din 07.02.2020 nr. T200419W-01-AN din 13.02.2020, eliberat de LI "Compliance Certification Services Inc., Bulgaria Laboratory", Tuzov, orașul "Tuzov", nr. 1830
- Certificat al sistemului de management al calitatii nr. 20445 IATF 16949 (IATF nr. 032829) din 18.12.2017 eliberat de "DQS Holding GmbH Germany"
- Certificat al sistemului de management al calitatii nr. 111 16225933 (IATF nr. 031439) din 01.08.2019 eliberat de "TUV Rheinland Certification Germany"
- Certificat de acreditare a procedurii de evaluare a conformității nr. 01-00-00
- Raport de evaluare final nr. 6320 din 14.08.2020.

PRODUCĂTORUL SUPLENTERIAR
Validitatea certificatului de conformitate se încheie în momentul încheierii procedurii de evaluare a conformității. Modificarea sau anularea documentelor sau a produselor implică necesitatea emiterii unui nou certificat. Eliberarea și modificarea pot fi actuate în baza de date nr. 196/10/01 și 43328-04, 99/00/01, pe pagina de Internet: www.nsi.gov.md
Sistem de emisie: ≤ 30 mW, Schema de emisie: Modulator

Conducătorul organismului de certificare:  Anoteziile GU/UN

Organismul de certificare este înregistrat în legalitatea din țara OC TIP. Seria A Nr. 002269

Information

Moldova models

CARD Keyless Access System

Intended use:
Short range device for remote control
Postal address:
45-29, SaEum-Road, Icheon-City,
Gyeonggi-do, Korea
Manufacturer name:
Continental Automotive Systems Corporation
Frequency band: 433.92MHz
Maximum transmitted output: 1mW
Importer Name:
Honda Motor Europe Ltd - Aalst Office
Postal address:
Wijngaardveld 1 (Noord V) 9300 Aalst - Belgium

EU Declaration of Conformity		
Product details		
Product	CARD ASSY ENTRY KEY	
Model	SV180CF000	
We hereby declare, that the product above is in compliance with the essential requirements of the Directive 2014/53/EU by application of:		
Applied Standards		
Article 3.2 Radio	EN 302 220-1 V2.1.1, EN 300 220-2 V2.1.1 EN 302 220-2 V2.1.1	
Article 3.3a EMC	EN 505 489-1 V2.1.1, EN 501 489-5 V2.1.1	
Article 3.3a Safety, Health	EN 62368-1:2020(A21):2020 EN 62479:2020	
Manufacturer		Representative in the EU
Continental Automotive Systems Corporation		Continental Automotive GmbH
45-29, SaEum-ro		Sternenstraße 12
Icheon-si, Gyeonggi-do, 17306, Korea		D-93055 Regensburg Germany
Tel. +82-33-645-4804		Tel. +49-941-790-9354
		Signed By 23/07/2020
		This declaration of conformity is issued under the sole responsibility of the manufacturer.
		 S. M. Jang Representative Continental Automotive Systems Corporation

Moldova models

Hands-Free Telephone System

Prin prezenta, Panasonic corporație declară că tipul de echipamente radio [AH2001] este în conformitate cu Reglementarea tehnică „Punerea la dispoziție pe piață a echipamentelor radio”.

Textul integral al declarației de conformitate este disponibil la următoarea adresă de

Internet:<https://service.panasonic.ua>

Intended use:

Sistem audio auto (Bluetooth și WLAN)

Postal address:

4261 Ikonobe-cho, Tsuzuki-ku, Yokohama-shi, Kanagawa-ken,
224-8520, Japonia

Manufacturer name:

Panasonic Corporation

Frequency band:

Specifications of Bluetooth Frequency band : 2402-2480MHz

Specifications of 2.4GHz WLAN Frequency band : 2412-2472MHz

Maximum transmitted output:

Bluetooth

Puterea maximă a frecvenței radio:0.1dBm

WLAN

Puterea maximă a frecvenței radio:11.9dBm

Importer Name:

Honda Motor Europe Ltd - Aalst Office

Postal address:

Wijngaardveld 1 (Noord V) 9300 Aalst - Belgium

Moldova models

Bluetooth Unit

Intended use:
 Vehicle Access System
 Postal address:
 Siemensstraße 12, D-93055 Regensburg, Germany
 Manufacturer name:
 Continental Automotive GmbH
 Frequency band:
 BLE frequency range: 2.402GHz to 2.48GHz
 Maximum transmitted output:
 BLE Maximum Output Power: +20dBm
 Importer Name:
 Honda Motor Europe Ltd - Aalst Office
 Postal address:
 Wijngaardveld 1 (Noord V) 9300 Aalst - Belgium



Moldova models

Telematics Control Unit

Prin prezenta, DENSO CORPORATION declară că tipul de echipamente radio este în conformitate cu Reglementarea tehnică „Punerea la dispoziție pe piață a echipamentelor radio”.

Textul integral al declarației de conformitate este disponibil la următoarea adresă de Internet:

<https://www.denso.com/global/en/contact-us/doc/>

Intended use: Telematics and Wi-Fi Hotspot device for Vehicle

Postal address: 1-1, Showa-cho, Kariya-shi, Aichi-ken, 448-8661, Japan

Manufacturer name: DENSO CORPORATION

Operational frequency band: Model OGEY10

- 1) GSM900 (Tx: 880-915 MHz, Rx: 925-960 MHz)
- 2) GSM1800 (Tx: 1710-1785 MHz, Rx: 1805-1880 MHz)
- 3) WCDMA Band1 (Tx: 1920-1980MHz, Rx: 2110-2170 MHz)
- 4) WCDMA Band3 (Tx: 1710-1785 MHz, Rx: 1805-1880 MHz)
- 5) WCDMA Band8 (Tx: 880-915 MHz, Rx: 925-960 MHz)
- 6) LTE Band1 (Tx: 1920-1980MHz, Rx: 2110-2170 MHz)
- 7) LTE Band3 (Tx: 1710-1785 MHz, Rx: 1805-1880 MHz)
- 8) LTE Band7 (Tx: 2500-2570 MHz, Rx: 2620-2690 MHz)
- 9) LTE Band8 (Tx: 880-915 MHz, Rx: 925-960 MHz)
- 10) LTE Band20 (Tx: 832-862 MHz, Rx: 791-821 MHz)
- 11) WLAN IEEE802.11b (Tx/Rx: 2401-2473 MHz)
- 12) WLAN IEEE802.11g (Tx/Rx: 2402-2472 MHz)
- 13) WLAN IEEE802.11n (Tx/Rx: 2402-2472 MHz)
- 14) GPS (Rx: 1575.42 MHz)
- 15) GALILEO (Rx: 1575.42 MHz)
- 16) EGNOS (Rx: 1575.42 MHz)

Maximum Output Power:

1) 2 W 2) 1 W 3-5) 0.25 W 6)-10) 0.20 W 11) 0.032 W 12),13) 0.016 W

Importer Name: Honda Motor Europe Ltd - Aalst Office

Postal address: Wijngaardveld 1 (Noord V) 9300 Aalst - Belgium



Moldova models

Blind spot information System*/Cross Traffic Monitor*



Intended use:
 24 GHz Short Range Radar Sensor
 Postal address:
 26545 American Drive Southfield, Michigan, 48034 United States of America
 Frequency band: 24.05 – 24.25 GHz
 Maximum transmitted output: 13 dBm peak
 Importer Name:
 Honda Motor Europe Ltd - Aalst Office
 Postal address:
 Wijngaardveld 1 (Noord V) 9300 Aalst - Belgium



Moldova models

Wireless Charger*	Remote Tuner
<p>https://www.lg.com/global/support/cedoc/cedoc (Input the model name : WC500HOCI21)</p>  <p>Prin prezenta, LG Electronics declară că tipul de echipamente radio WC500HOCI21 este în conformitate cu Reglementarea tehnică „Punerea la dispoziție pe piață a echipamentelor radio”.</p> <p>Textul integral al declarației de conformitate este disponibil la următoarea adresă de Internet: https://www.lg.com/global/support/cedoc/cedoc</p> <p>Intended use: Wireless Power Charger for vehicle Postal address: 128, Yeoui-daero, Yeongdeungpo-gu, Seoul, Korea Manufacturer name: LG Electronics Operational frequency band: 111kHz/max power : 42dBuA/m @10m Maximum Output Power: 111kHz/max power : 42dBuA/m @10m Importer Name: Honda Motor Europe Ltd - Aalst Office Postal address: Wijngaardveld 1 (Noord V) 9300 Aalst - Belgium</p>	<p>https://service.panasonic.ua</p>  <p>Prin prezenta, Panasonic corporație declară că tipul de echipamente radio [CQ-TH4BE0AJ] este în conformitate cu Reglementarea tehnică „Punerea la dispoziție pe piață a echipamentelor radio”.</p> <p>Textul integral al declarației de conformitate este disponibil la următoarea adresă de Internet: https://service.panasonic.ua</p> <p>Intended use: RADIO UNIT (Car radio tuner) Postal address: 4261 Ikonobe-cho, Tsuzuki-ku, Yokohama-shi, Kanagawa-ken, 224-8520, Japan Manufacturer name: Panasonic Corporation Importer Name: Honda Motor Europe Ltd - Aalst Office Postal address: Wijngaardveld 1 (Noord V) 9300 Aalst - Belgium</p>

EU Countries

<p>BCM Keyless Access System</p>	<p>FOB Keyless Remote</p>
<p>http://continental-homologation.com/honda</p>	<p>http://continental-homologation.com/honda</p>
	
<p>Hereby, Continental Automotive GmbH declares that this model [41580430] is in compliance with the essential requirements and other relevant provisions of Directive 2014/53/EU. The full text of the EU declaration of conformity is available at the following internet address: https://continental-homologation.com/honda Intended use: Short range device for remote control Postal address: Siemensstrasse 12 D-93055 Regensburg Germany Manufacturer name: Continental Automotive GmbH Frequency band: 125KHz Maximum transmitted output: 10mW Importer Name: Honda Motor Europe Ltd - Aalst Office Postal address: Wijngaardveld 1 (Noord V) 9300 Aalst - Belgium</p>	<p>Hereby, Continental Automotive GmbH declares that this model [TP_4] is in compliance with the essential requirements and other relevant provisions of Directive 2014/53/EU. The full text of the EU declaration of conformity is available at the following internet address: https://continental-homologation.com/honda Intended use: Short range device for remote control Postal address: Siemensstrasse 12 D-93055 Regensburg Germany Manufacturer name: Continental Automotive GmbH Frequency band: 433.92MHz Maximum transmitted output: 1mW Importer Name: Honda Motor Europe Ltd - Aalst Office Postal address: Wijngaardveld 1 (Noord V) 9300 Aalst - Belgium</p>

EU Countries



CARD



Intended use:
 Short range device for remote control
 Postal address:
 45-29, SaEum-Road, Icheon-City, Gyeonggi-do, Korea
 Manufacturer name:
 Continental Automotive Systems Corporation
 Frequency band: 433.92MHz
 Maximum transmitted output: 1mW
 Importer Name:
 Honda Motor Europe Ltd - Aalst Office
 Postal address:
 Wijngaardveld 1 (Noord V) 9300 Aalst - Belgium

EU Declaration of Conformity		Continental
Product details		
Product	CARD ASSY ENTRY KEY	
Model	SVR40CTG00	
We hereby declare, that the product above is in compliance with the essential requirements of the Directive 2014/53/EU by application of:		
Applied Standards		
Article (1) 3.2 Radio	EN 300 220-1 V3.1.1, EN 300 220-2 V3.2.1 EN 300 330 V2.1.1	
Article (1) 3.3b EMC	EN 301 489-1 V2.1.1, EN 301 489-3 V2.1.1	
Article (1) 3.1a Safety (incl. Health)	EN 62368-1:2020/H4.1:2020 EN 62479:2020	
Manufacturer		Representative in the EU
Continental Automotive Systems Corporation		Continental Automotive GmbH
45-29, SaEum-ro		Siemensstraße 12
Icheon-si Gyeonggi-do, 17306, Korea		D-93265 Regensburg Germany
Tel: +82-32-645-6804		Tel: +49-940-790-3334
		Signed By 21/07/2020
		This declaration of conformity is issued under the sole responsibility of the manufacturer.
		 S. M. Jung Representative Continental Automotive Systems Corporation

EU Countries

Hands-Free Telephone System	Blind spot information system*/Cross Traffic Monitor*
<p>http://www.ptc.panasonic.eu/</p>  <p>Hereby, Panasonic Corporation declares that the radio equipment type Listed above is in compliance with Directive 2014/53/EU. Access to http://www.ptc.panasonic.eu/, click "Declaration of Conformity", enter the below Keyword into the keyword search box, you can download the latest "DECLARATION of CONFORMITY" (DoC). Keyword:: [CL-MH4BE0JT,CL-MH4BE1JT,CL-MH4BE6JT,CL-MH4BE2JT,CL-MH4BE3JT,CL-MH4BE4JT,CL-MH4BE7JT,CL-MH4BE5JT,CL-MH4AX0JT,CL-MH4BX1JT,CL-MH4BX2JT,CL-MH4BX3JT] Intended use: Car Audio System (Bluetooth and WLAN) Postal address: 4261 Ikonobe-cho, Tsuzuki-ku, Yokohama-shi, Kanagawa-ken, 224-8520, Japan Manufacturer name: Panasonic Corporation Operational frequency band: Specifications of Bluetooth Frequency band : 2402-2480MHz Specifications of 2.4GHz WLAN Frequency band : 2412-2472MHz Maximum Output Power: Specifications of Bluetooth Maximum output power : 0.1dBm Specifications of 2.4GHz WLAN Maximum output power : 11.9dBm Importer Name: Honda Motor Europe Ltd - Aalst Office Postal address: Wijngaardveld 1 (Noord V) 9300 Aalst - Belgium</p>	<p>https://www.veoneer.com/en/regulatory</p>  <p>Hereby, Veoneer US, Inc. declares that the object of the declaration described above is in conformity with the relevant Union harmonisation legislation. https://www.veoneer.com/en/regulatory Intended use: 24 GHz Short Range Radar Sensor Postal address: 26545 American Drive Southfield, Michigan, 48034 United States of America Manufacturer name: Veoneer US, Inc. Operational frequency band: 24.05 – 24.25 GHz Maximum Output Power: 13 dBm peak Importer Name: Honda Motor Europe Ltd - Aalst Office Postal address: Wijngaardveld 1 (Noord V) 9300 Aalst - Belgium</p>

* Not available on all models

Continued

EU Countries

Telematics Control Unit

<https://www.denso.com/global/en/contact-us/doc/>



Hereby, DENSO CORPORATION declares that the radio equipment type is in compliance with Directive 2014/53/EU. The full text of the EU declaration of conformity is available at the following internet address:

<https://www.denso.com/global/en/contact-us/doc/>

Intended use: Telematics and Wi-Fi Hotspot device for Vehicle

Postal address:

1-1, Showa-cho, Kariya-shi, Aichi-ken, 448-8661, Japan

Manufacturer name: DENSO CORPORATION

Operational frequency band: Model OGEY10

- 1) GSM900 (Tx: 880-915 MHz, Rx: 925-960 MHz)
- 2) GSM1800 (Tx: 1710-1785 MHz, Rx: 1805-1880 MHz)
- 3) WCDMA Band1 (Tx: 1920-1980 MHz, Rx: 2110-2170 MHz)
- 4) WCDMA Band3 (Tx: 1710-1785 MHz, Rx: 1805-1880 MHz)
- 5) WCDMA Band8 (Tx: 880-915 MHz, Rx: 925-960 MHz)
- 6) LTE Band1 (Tx: 1920-1980MHz, Rx: 2110-2170 MHz)
- 7) LTE Band3 (Tx: 1710-1785 MHz, Rx: 1805-1880 MHz)
- 8) LTE Band7 (Tx: 2500-2570 MHz, Rx: 2620-2690 MHz)
- 9) LTE Band8 (Tx: 880-915 MHz, Rx: 925-960 MHz)
- 10) LTE Band20 (Tx: 832-862 MHz, Rx: 791-821 MHz)
- 11) WLAN IEEE802.11b (Tx/Rx: 2401-2473 MHz)
- 12) WLAN IEEE802.11g (Tx/Rx: 2402-2472 MHz)
- 13) WLAN IEEE802.11n (Tx/Rx: 2402-2472 MHz)
- 14) GPS (Rx: 1575.42 MHz)
- 15) GALILEO (Rx: 1575.42 MHz)
- 16) EGNOS (Rx: 1575.42 MHz)



Maximum Output Power:

- 1) 2 W 2) 1 W 3-5) 0.25 W 6)-10) 0.20 W 11) 0.032 W 12),13) 0.016 W

Importer Name: Honda Motor Europe Ltd - Aalst Office

Postal address: Wijngaardveld 1 (Noord V) 9300 Aalst - Belgium

EU Countries

Wireless Charger*	BTU
<p>https://www.lg.com/global/support/cedoc/cedoc</p>  <p>Hereby, LG Electronics Inc. declares that the radio equipment type WC500HOC121 is in compliance with Directive 2014/53/EU. The full text of the EU declaration of conformity is available at the following internet address: https://www.lg.com/global/support/cedoc/cedoc Intended use: Wireless Power Charger for vehicle Importer Name: Honda Motor Europe Ltd - Aalst Office Postal address: Wijngaardveld 1 (Noord V) 9300 Aalst - Belgium</p>	<p>https://continental-homologation.com/honda</p>  <p>Hereby, Continental declares that the radio equipment type A2C192350/ A2C192351 is in compliance with Directive 2014/53/EU. The full text of the EU declaration of conformity is available at the following internet address: https://continental-homologation.com/honda Intended use: Vehicle Access System Postal address: Siemensstraße 12, D-93055 Regensburg, Germany Manufacturer name: Continental Automotive GmbH Operational frequency band: BLE frequency range: 2.402GHz to 2.48GHz Maximum Output Power: BLE Maximum Output Power: +20dBm Importer Name: Honda Motor Europe Ltd - Aalst Office Postal address: Wijngaardveld 1 (Noord V) 9300 Aalst - Belgium</p>

EU Countries

Remote Tuner

<http://www.ptc.panasonic.eu/>



Hereby, Panasonic Corporation declares that the radio equipment type Listed above is in compliance with Directive 2014/53/EU.

Access to <http://www.ptc.panasonic.eu/>, click "Declaration of Conformity", enter the below Keyword into the keyword search box, you can download the latest "DECLARATION of CONFORMITY" (DoC). Keyword: Model No.

Keyword: [CQ-TH4BE0AJ]

You can see "Ref No" in unit label.

Intended use:

RADIO UNIT (Car radio tuner)

Postal address:

4261 Ikonobe-cho, Tsuzuki-ku, Yokohama-shi, Kanagawa-ken,
224-8520, Japan

Manufacturer name:

Panasonic Corporation

Importer Name:

Honda Motor Europe Ltd - Aalst Office

Postal address:

Wijngaardveld 1 (Noord V) 9300 Aalst - Belgium

British models

BCM Keyless Access System	FOB Keyless Remote
<p><i>http://continental-homologation.com/honda</i></p> <p style="text-align: center;">UK CA</p> <p>Hereby, Continental Automotive GmbH declares that this model [41580430] is in compliance with the essential requirements and other relevant provisions of Radio Equipment Regulations 2017. The full text of the UK declaration of conformity is available at the following internet address: <i>http://continental-homologation.com/honda</i></p> <p>Intended use: Short range device for remote control</p> <p>Postal address: Siemensstrasse 12 D-93055 Regensburg Germany Manufacturer name: Continental Automotive GmbH Frequency band: 125kHz +/- 3kHz Maximum transmitted output: 66dBuA/m at 10m</p> <p>Importer Name: Honda Motor Europe Ltd. Postal address: Cain Road, Bracknell, Berkshire, RG12 1HL, United Kingdom</p>	<p><i>http://continental-homologation.com/honda</i></p> <p style="text-align: center;">UK CA</p> <p>Hereby, Continental Automotive GmbH declares that this model [TP_4] is in compliance with the essential requirements and other relevant provisions of Radio Equipment Regulations 2017. The full text of the UK declaration of conformity is available at the following internet address: <i>http://continental-homologation.com/honda</i></p> <p>Intended use: Short range device for remote control</p> <p>Postal address: Siemensstrasse 12 D-93055 Regensburg Germany Manufacturer name: Continental Automotive GmbH Frequency band: 433.66MHz+/-16kHz 434.18MHz+/-16kHz Maximum transmitted output: 1mW</p> <p>Importer Name: Honda Motor Europe Ltd. Postal address: Cain Road, Bracknell, Berkshire, RG12 1HL, United Kingdom</p>

British models

Hands-Free Telephone System

<https://www.ptc.panasonic.eu/>



Hereby, Panasonic Corporation declares that the radio equipment type [*] is in compliance with The Radio Equipment Regulations 2017. The full text of the UK declaration of conformity is available at the following internet address:

<https://www.ptc.panasonic.eu/>

enter the below Keyword into the keyword search box, you can download the latest "DECLARATION of CONFORMITY" (DoC).

* Keyword: [CL-MH-----, CA-9H-----,

CL-MH39E2JT, CL-MH39E3JT, CA-9H39E0JT, CA-9H39E3JT, CL-MH39E1JT, CL-MH39EJIT, CL-MH39E0JT, CL-MH3AZ1JT, CA-9H39E4JT, CA-9H39E5JT, CA-9H39E6JT, CA-9H39E7JT, CL-MH4BE0JT, CL-MH4BE1JT, CL-MH4BE6JT, CL-MH4BE2JT, CL-MH4AX0JS, CL-MH4BE1JR, CL-MH4BE2JR, CL-MH4BE3JR, CL-MH1BX1JT, CL-MH1AE6JT, CL-MH1AE0JT, CL-MH1AE2JT, CL-MH1BX0JS, CL-MH1BX2JS, CL-MH1BX3JS, CL-MH1BX4JS] You can see "Ref No" in unit label.

Intended use: Car Audio System (Bluetooth and WLAN)

Postal address: 4261 Ikonobe-cho, Tsuzuki-ku, Yokohama-shi, Kanagawa-ken, 224-8520, Japan

Manufacturer name: Panasonic Corporation

Operational frequency band:

Specifications of Bluetooth

Frequency band : 2402-2480MHz

Specifications of 2.4GHz WLAN

Frequency band : 2412-2472MHz

Maximum Output Power:

Specifications of Bluetooth

Maximum output power : 0.1dBm

Specifications of 2.4GHz WLAN

Maximum output power : 11.9dBm

Importer Name: Honda Motor Europe Ltd.

Postal address: Cain Road, Bracknell, Berkshire, RG12 1HL, United Kingdom

British models

Telematics Control Unit

<https://www.denso.com/global/en/contact-us/doc/>



Hereby, DENSO CORPORATION declares that the radio equipment type is in compliance with the relevant statutory requirements. The full text of the UK declaration of conformity is available at the following internet address:

<https://www.denso.com/global/en/contact-us/doc/>

Intended use: Telematics and Wi-Fi Hotspot device for Vehicle

Postal address:

1-1, Showa-cho, Kariya-shi, Aichi-ken, 448-8661, Japan

Manufacturer name: DENSO CORPORATION

Operational frequency band: Model OGEY10

- 1) GSM900 (Tx: 880-915 MHz, Rx: 925-960 MHz)
- 2) GSM1800 (Tx: 1710-1785 MHz, Rx: 1805-1880 MHz)
- 3) WCDMA Band1 (Tx: 1920-1980 MHz, Rx: 2110-2170 MHz)
- 4) WCDMA Band3 (Tx: 1710-1785 MHz, Rx: 1805-1880 MHz)
- 5) WCDMA Band8 (Tx: 880-915 MHz, Rx: 925-960 MHz)
- 6) LTE Band1 (Tx: 1920-1980MHz, Rx: 2110-2170 MHz)
- 7) LTE Band3 (Tx: 1710-1785 MHz, Rx: 1805-1880 MHz)
- 8) LTE Band7 (Tx: 2500-2570 MHz, Rx: 2620-2690 MHz)
- 9) LTE Band8 (Tx: 880-915 MHz, Rx: 925-960 MHz)
- 10) LTE Band20 (Tx: 832-862 MHz, Rx: 791-821 MHz)
- 11) WLAN IEEE802.11b (Tx/Rx: 2401-2473 MHz)
- 12) WLAN IEEE802.11g (Tx/Rx: 2402-2472 MHz)
- 13) WLAN IEEE802.11n (Tx/Rx: 2402-2472 MHz)
- 14) GPS (Rx: 1575.42 MHz)
- 15) GALILEO (Rx: 1575.42 MHz)
- 16) EGNOS (Rx: 1575.42 MHz)

Maximum Output Power:

- 1) 2 W 2) 1 W 3-5) 0.25 W 6)-10) 0.20 W 11) 0.032 W 12),13) 0.016 W

Importer Name: Honda Motor Europe Ltd.

Postal address: Cain Road, Bracknell, Berkshire, RG12 1HL, United Kingdom

British models

Blind spot information system*/Cross Traffic Monitor*	BTU
<p>https://www.veoneer.com/en/regulatory</p> <p style="text-align: center;">UK CA</p> <p>Hereby, Veoneer US, Inc. declares that the object of the declaration described above is in conformity with the relevant Union harmonisation legislation.</p> <p>https://www.veoneer.com/en/regulatory Intended use: 24 GHz Short Range Radar Sensor Postal address: 26545 American Drive Southfield, Michigan, 48034 United States of America Manufacturer name: Veoneer US, Inc. Operational frequency band: 24.05 – 24.25 GHz Maximum Output Power: 13 dBm peak Importer Name: Honda Motor Europe Ltd. Postal address: Cain Road, Bracknell, Berkshire, RG12 1HL, United Kingdom</p>	<p>https://continental-homologation.com/honda</p> <p style="text-align: center;">UK CA</p> <p>Hereby, Continental Automotive GmbH declares that this model [A2C775684] is in compliance with the essential requirements and other relevant provisions of Radio Equipment Regulations 2017. The full text of the UK declaration of conformity is available at the following internet address: http://continental-homologation.com/honda</p> <p>Intended use: Control Unit Postal address: Siemensstraße 12, D-93055 Regensburg, Germany Manufacturer name: Continental Automotive GmbH Operational frequency band: BLE frequency range: 2.402GHz to 2.48GHz Maximum Output Power: BLE Maximum Output Power: +20dBm Importer Name: Honda Motor Europe Ltd. Postal address: Cain Road, Bracknell, Berkshire, RG12 1HL, United Kingdom</p>

British models

Remote Tuner

<https://www.ptc.panasonic.eu/>



Hereby, Panasonic Corporation declares that the radio equipment type [*] is in compliance with The Radio Equipment Regulations 2017. The full text of the UK declaration of conformity is available at the following internet address:

<https://www.ptc.panasonic.eu/>

enter the below Keyword into the keyword search box, you can download the latest "DECLARATION of CONFORMITY" (DoC).

* Keyword: [CQ-TH-----, CQ-TH28E0AJ, CQ-TH28E0BJ, CQ-TH39E1AJ, CQ-TH39E1BJ, CQ-TH39E0AJ, CQ-TH39E0BJ, CQ-TH1BE0AJ, CQ-TH1BE0BJ, CQ-TH1BE1AJ, CQ-TH1BE1BJ, CQ-TH1AE0TT, CQ-TH1AE0TS, CQ-TH2BE0AD, CQ-TH2BE0BD, CQ-THVCE0AD, CQ-THVCE0BD, CQ-TH4BE0AJ, CQ-TH4BE0BJ, CQ-THVCE1AD, CQ-THVCE1BD] You can see "Ref No" in unit label.

Intended use:

Radio unit (Car radio tuner)

Postal address:

4261 Ikonobe-cho, Tsuzuki-ku, Yokohama-shi, Kanagawa-ken, 224-8520, Japan

Manufacturer name:

Panasonic Corporation

Importer Name:

Honda Motor Europe Ltd.

Postal address:

Cain Road, Bracknell, Berkshire, RG12 1HL, United Kingdom

British models

Wireless Charger*

<https://www.lg.com/global/support/cedoc/cedoc>
(Input the model name : WC500HOC121)



Hereby, LG Electronics declares that the radio equipment type wireless charger is in compliance with the relevant statutory requirements. The full text of the UK declaration of conformity is available at the following internet address : <http://www.lg.com/global/support/cedoc/cedoc>

Intended use:

Wireless Power Charger for vehicle

Postal address:

128, Yeoui-daero, Yeongdeungpo-gu, Seoul, Korea

Manufacturer name:

LG Electronics

Operational frequency band:

111kHz/max power : 42dBuA/m @10m

Maximum Output Power:

111kHz/max power : 42dBuA/m @10m

Importer Name:

Honda Motor Europe Ltd.

Postal address:

Cain Road, Bracknell, Berkshire, RG12 1HL, United Kingdom

British models

Compressor

EN

UKCA declaration of conformity in accordance with The General Product Safety Regulations 2005

We, SUMITOMO RUBBER INDUSTRIES, LTD., 6-9, 3-chome, Wakinocho, Kobe 651-0071, Japan, hereby declare that the machine described below conforms with the general health and safety requirements laid down in The General Product Safety Regulations 2005 by virtue of its design and construction and in the configuration brought to market by us. Any alterations made to the machine without our approval shall render this declaration invalid.

Designation: We declare that the product also conforms with other applicable directives for a product of this type: Supply of Machinery Regulations 2008,

Electromagnetic Compatibility Regulations 2016.

The following harmonized standards are applied in particular: BS EN ISO 12100-2011, BS EN 62841-1: 2015, BS EN 55014-1: 2012, BS EN 55014-2: 2012.

Kobe, June 17 2021, Yukinori Nagata (General Manager IMS Business Team)

* Not available on all models

Numbers

12-Volt Battery.....	546
Charging System Indicator.....	107, 593
Maintenance (Checking the 12-Volt Battery).....	546
Maintenance (Replacing).....	549
12-Volt Battery Charging System Indicator.....	107, 593

A

ABS (Anti-lock Brake System).....	478
Accessories and Modifications.....	564
Accessory Power Sockets.....	230
Acoustic Vehicle Alerting System.....	370
Adaptive Cruise Control (ACC) with Low Speed Follow.....	423
Indicator (Amber).....	116
Indicator (White/Green).....	116
Adding.....	
Coolant.....	524
Engine Oil.....	523
Washer.....	529
Additives, Engine Oil.....	520
Adjustable Speed Limiter.....	376
Indicator.....	115
Adjusting.....	
Armrest.....	218
Front Seats.....	208
Head Restraints.....	215

Headlights.....	192
Mirrors.....	203
Steering Wheel.....	202
Adjusting Headlight Distribution.....	400
Adjusting the Sound.....	269
Agile Handling Assist.....	391
Air Conditioning System (Climate Control System).....	236
Air Outlet.....	242
Changing the Mode.....	238
Defrosting the Windscreen and Windows.....	239
Dust and Pollen Filter.....	555
Recirculation/Fresh Air Mode.....	238
Sensor.....	243
Synchronization Mode.....	241
Using Automatic Climate Control.....	236
Air Outlet.....	242
Air Pressure.....	611
Airbags.....	58
After a Collision.....	60
Airbag Care.....	72
Event Data Recorder.....	1
Front Airbags (SRS).....	60
Indicator.....	70, 109
Sensors.....	58
Side Airbags.....	66
Side Curtain Airbags.....	68
AM/FM Radio.....	276
Ambient Meter.....	133
Android Auto.....	300

Anti-lock Brake System (ABS).....	478
Indicator.....	109
Apple CarPlay.....	296
Armrest.....	218
Arrange Contents.....	148
Audio.....	143
Audio Remote Controls.....	252
Audio System.....	246
Adjusting the Sound.....	269
AM/FM Radio.....	276
Android Auto.....	300
App Shortcut Function.....	259
Apple CarPlay.....	296
Audio Remote Controls.....	252
Audio System Function.....	249
Audio/Information Screen.....	258
Basic Operation.....	249
Bluetooth® Audio.....	291
Clock Setup.....	266
DAB.....	281
Display Setup.....	270
Error Messages.....	337
FLAC/PCM/WAVE/MP4/AVI/MKV/ASF/WMV.....	287
General Information.....	338
How to Update.....	271
How to Update Wirelessly.....	274
How to Update with a USB Device.....	275
iPod.....	284
Limitations for Manual Operation.....	265
MP3/WMA/AAC.....	287

On-Board Owner's Manual	254	High Voltage	14, 399	Taillights.....	531, 533
Radio Data System (RDS).....	279	If the 12-Volt Battery Is Dead.....	587	Vanity Mirror Light Bulbs	535
Reactivating	247	Belts (Seat)	45	Bulb Specifications	610
Security Code	247	Beverage Holders	223		
Selecting an Audio Source	264	Blind spot information System	394		
Start Up.....	248	Bluetooth® Audio	291		
Status Area	264	Booster Seats (For Children)	96		
System Updates	271	Brake System	471		
System Updates Settings	272	Anti-lock Brake System (ABS).....	478		
Theft Protection	247	Automatic Brake Hold	475		
USB Flash Drives.....	287, 338	Brake Assist System	479		
USB Ports.....	251	Fluid	528		
Voice Control Operation	255	Foot Brake	474		
Wallpaper Setup	267	Indicator	104, 105, 106, 595, 597		
Wi-Fi Connection	294	Parking Brake	471		
Audio System Theft Protection	247	Brightness Control (Instrument Panel)	201		
Audio/Information Screen	258	Bulb Replacement	530		
Auto High-Beam	193	Active Cornering Lights	530		
Automatic Brake Hold	475	Back-Up Lights	533		
Indicator	106, 475	Brake Lights.....	531		
Automatic Folding Door Mirror		Daytime Running Lights.....	530		
Function.....	206	Front Fog Lights.....	530		
Automatic Intermittent Wipers	197	Front Turn Signal Lights	530		
Average Fuel Economy	140	Headlights	530		
Average Speed	142	High-Mount Brake Light	534		
		Position Lights	530		
		Rear Fog Light	533		
		Rear Licence Plate Light	534		
		Rear Turn Signal Lights	531		
		Side Turn Signal/Emergency Indicator			
		Lights	530		

B

Battery	14
12-Volt Battery Charging System	
Indicator	107, 593

C

Carbon Monoxide Gas	98
Carrying Luggage	353, 355
Certification Label	612
Changing Bulbs	530
Child Restraint System	73
Booster Seats	96
Child Restraint System for Infants.....	76
Child Restraint System for Small	
Children	78
Installing a Child Restraint System	
with a Lap/Shoulder Seat Belt	91
Larger Children	95
Rear-facing Child Restraint System	76
Selecting a Child Restraint System	79
Using a Tether.....	93
Child Safety	73
Childproof Door Locks.....	162
Childproof Door Locks	162
Cleaning the Exterior	560
Cleaning the Interior	558
Climate Control System	236
Air Outlet.....	242
Changing the Mode	236
Defrosting the Windscreen and	
Windows.....	239

- Dust and Pollen Filter 555
 - Recirculation/Fresh Air Mode 238
 - Sensors..... 243
 - Synchronization Mode..... 241
 - Using Automatic Climate Control 236
 - Clock 134, 150
 - CMBS (Collision Mitigation Braking System)** 405
 - Coat Hooks**..... 224
 - Collision Mitigation Braking System (CMBS)** 405
 - Console Box**..... 222
 - Controls** 149
 - Coolant (Engine)**
 - Overheating..... 591
 - Cooling System** 524
 - Adding to the Radiator 526
 - Adding to the Reserve Tank 524
 - Creeping**..... 364
 - Cross Traffic Monitor**..... 488
 - Current Mode for ACC with Low Speed Follow and the LKAS** 134
 - Customize Display**..... 148
 - Customized Features** 304, 311
- D**
- DAB**..... 281
 - Daytime Running Lights**..... 189
 - Dead Battery**..... 587
 - Deceleration Paddle Selector**..... 367
 - Declaration of conformity Content Outline** 655
 - Defaulting All the Settings**..... 317
 - Deflation Warning System**..... 392
 - Calibration 392
 - Indicator..... 112, 598
 - Defrosting the Windscreen and Windows** 239
 - Demister**..... 199
 - Devices that Emit Radio Waves** 613
 - Dimming**
 - Headlights..... 183
 - Rearview Mirror..... 203
 - Dipstick (Engine Oil)**..... 522
 - Display Audio** 248
 - Display Setup**..... 270
 - Door Mirrors** 204
 - Doors** 151
 - Keys..... 151
 - Locking/Unlocking the Doors from the Inside 160
 - Locking/Unlocking the Doors from the Outside 154
 - Lockout Prevention System..... 159
 - Drive Mode Switch** 371
 - Driver Information Interface** 135
 - Switching the Display 135
 - Driving** 351
 - Braking 471
 - Shifting Gear..... 365
 - Transmission 364
 - Driving Guidelines for Your Utility Vehicle** 362
 - Dust and Pollen Filter** 555
- E**
- e:HEV** 13
 - eCall Indicator** 344
 - Elapsed Time** 142
 - Electric Power Steering (EPS) System Indicator** 111, 596
 - Emergency Call (eCall)** 344
 - Automatic Emergency Call 344
 - Manual Emergency Call 346
 - Emergency Stop Signal** 480
 - Emergency Towing** 606
 - Engine**
 - If the 12-Volt Battery Is Dead 587
 - Number 612
 - Oil 520
 - Switch Buzzer 181, 182
 - Engine Coolant**
 - Overheating..... 591
 - Engine Oil**..... 520
 - Adding 523
 - Checking 522
 - Engine Oil Pressure Low Warning..... 593
 - Recommended Engine Oil 520
 - Engine Oil Level Low Warning**..... 599
 - Engine Oil Pressure Low Warning** 593

EPS (Electric Power Steering)	
System.....	111, 596
EV Indicator.....	107
Exhaust Gas Hazard	
(Carbon Monoxide).....	98
Exterior Care (Cleaning).....	560
Exterior Mirrors.....	204
F	
Features.....	245
Filter	
Dust and Pollen.....	555
Flat Tyre.....	569
Fluids	
Brake.....	528
Cooling System.....	524
Windscreen Washer.....	529
FM/AM Radio.....	276
Folding Down the Rear Seats.....	210
Foot Brake.....	474
Front Airbags (SRS).....	60
Front Fog Light Indicator.....	111
Front Seat Heaters.....	235
Front Seats.....	207
Adjusting.....	208
Front Wide View Camera.....	468
Fuel.....	30, 495
Economy and CO ₂ Emissions.....	498
Gauge.....	132
Instant Fuel Economy.....	140

Low Fuel Indicator.....	109
Range.....	140
Recommendation.....	495
Refueling.....	495
Fuel Economy and CO ₂ Emissions.....	498
Fuel Fill Cap.....	30, 496
Fuel Fill Door.....	30, 496
Fuses.....	600
Inspecting and Changing.....	605
Locations.....	600, 601, 602, 603, 604

G

Gauges.....	132
Glass (care).....	559, 561
Glove Box.....	222

H

Hands-Free Telephone System.....	318
Automatic Import of Mobile Phonebook and	
Recent calls.....	328
Automatic Transferring.....	329
Favourite Contacts.....	330
HFT Buttons.....	318
HFT Menus.....	322
HFT Status Display.....	320
Limitations for Manual Operation.....	321
Making a Call.....	333
Options During a Call.....	336
Phone Settings Screen.....	324

Phone Setup.....	325
Receiving a Call.....	335
Ring Tone.....	329
Hazard Warning Button.....	6, 7
Head Restraints.....	215
Headlights.....	183
Adjuster.....	192
Aiming.....	530
Auto High-Beam.....	193
Dimming.....	183
Operating.....	183
Heated Door Mirror Button.....	199
Heated Steering Wheel.....	234
Heated Windscreen Button.....	200
Heaters (Front Seat).....	235
HFT (Hands-Free Telephone).....	318
High Voltage Battery.....	399
High-Beam Indicator.....	111
Hill Descent Control System.....	374
Indicator.....	115
Hill Start Assist System.....	361
Honda Sensing.....	31, 402
Hybrid Vehicle	
e:HEV.....	13
Hydrophilic Mirror.....	563
I	
Identification Numbers.....	612
Engine, Motor and Transmission.....	612
Vehicle Identification.....	612

Lights	183, 530
Active Cornering Lights.....	190
Bulb Replacement	530
Daytime Running Lights	189
Fog Light	187
Front Fog Lights	187
High-Beam Indicator Light.....	111
Interior.....	219
Light Switches.....	183
Lights On Indicator.....	111
Luggage Area Lights	221
Load Limits	355
Locking/Unlocking	151
Childproof Door Locks	162
From Inside	160
From Outside	154
Keys.....	151
Using a Key.....	158
Locking/Unlocking the Doors from the Outside.....	154
Lockout Prevention System	159
Low Battery Charge	593
Low Fuel Indicator	109
Low Keyless Remote Signal Strength	153
Low Speed Braking Control	417
Low Tyre Pressure/Deflation Warning System Indicator	112, 598
Lower Anchorages	87
Lubricant Specifications Chart	611
Luggage (Load Limit).....	355
Luggage Area Cover	227

Luggage Hook	225
--------------------	-----

M

Maintenance.....	145, 499
12-Volt Battery	546
Brake Fluid	528
Cleaning.....	558
Climate Control	554
Cooling System	524
Oil	522
Precautions.....	500
Radiator	526
Remote Transmitter	552
Replacing Light Bulbs.....	530
Safety.....	501
Service Reminder System	504
Transmission Fluid	527
Tyres	541
Under the Bonnet	517
Malfunction Indicator Lamp	107, 594
Map Light Switches	220
Maximum Permissible Weight	355
Meters, Gauges.....	132
Mirrors.....	203
Adjusting.....	203
Door.....	204
Interior Rearview	203
Modifications (and Accessories)	564
MP3/WMA/AAC	287
Multi-View Rear Camera.....	493

N

Navigation	143
Numbers (Identification).....	612

O

Odometer	133
Off-road Guidelines	357
Oil (Engine).....	520
Adding.....	523
Checking.....	522
Engine Oil Pressure Low Indicator	593
Recommended Engine Oil	520
Viscosity	520
On-Board Owner's Manual.....	254
Open the Owner's Manual	254
Open Source Licences.....	341
Opening/Closing	
Bonnet.....	518
Power Windows	177
Tailgate.....	163
Other Interior Convenience Items.....	229
Outside Temperature Display.....	133
Overheating.....	591

P

Parking Brake	471
Parking Brake and Brake System Indicator.....	595

Parking Brake and Brake System Indicator (Amber)	106, 597
Parking Brake and Brake System Indicator (Red)	104, 105, 597
Parking Sensor System	483
Passenger Front Airbag Off System	63
Passenger Front Airbag On/Off Indicator	71, 110
Passing Indicators	183
Petrol	30, 495
Economy and CO ₂ Emissions	498
Gauge	132
Information	495
Instant Fuel Economy	140
Low Fuel Indicator	109
Refueling	495
Phone	143
Playing <i>Bluetooth</i> [®] Audio	291
POWER Button	180
Power Flow/Engine Status Display/High Voltage Battery Charge Level Gauge	138
Power System	
Won't Start	583
Power System Indicator	107
Power Windows	177
Power/Charge	137
POWER/CHARGE Gauge	132
Precautions While Driving	362
Rain	363
Pregnant Women	55
Puncture (Tyre)	569

R

Radiator	526
Radio (AM/FM)	276
Radio Data System (RDS)	279
Range	140
Range / Fuel / Trip Meter	139
RDS (Radio Data System)	279
Ready Indicator	107
Rear Demister	199
Rear Fog Light Indicator	112
Rear Seat Reminder	213
Rear Seats	210
Rearview Mirror	203
Reduced Stopping Power Warning	594
Refuel Recommend	349
Refueling	495
Fuel Gauge	132
Low Fuel Indicator	109
Petrol	495, 610
Regulations	613
Remote Transmitter	157
Replacement	
12-Volt Battery	549
Bulbs	530
Front Wiper Blade Rubber	536
Fuses	600, 601, 602, 603, 604
Rear Wiper Blade Rubber	539
Remote Battery	552
Resetting a Trip Meter	140
Reverse Tilt Door Mirror	205

Road Departure Mitigation	453
On and Off	456
Road Departure Mitigation Ready to Assist Indicator	117

S

Safe Driving	39
Safety Labels	99
Safety Message	0
Safety Support	146
Indicator (Amber)	117, 118, 119
Indicator (Green/Grey)	119
Seat Belts	45, 145
Adjusting the Shoulder Anchorage	52
Automatic Seat Belt Tensioners	49
Checking	56
Fastening	50
Installing a Child Restraint System with a Lap/Shoulder Seat Belt	91
Pregnant Women	55
Reminder	47
Warning Indicator	47, 48, 109
Seat Heaters	235
Seats	207
Adjusting	207
Front Seat Heaters	235
Front Seats	207
Rear Seats	210
Seat Heaters	235

Security System	174	Stopping.....	481	Operating the Shift Lever.....	365
Immobilizer System Indicator.....	113	Storage Items.....	222	Operation.....	27
Security System Alarm Indicator	113	Sun Visor	229	Shift Lever Does Not Move	590
Super Locking	176	Super Locking	176	Trip Meter	140, 142
Select Lever	27	Super UV Cut Glass.....	559	TRK (Temporary Repair Kit)	569
Selecting a Child Restraint System.....	79	Supplemental Restraint System (SRS).....	60	Troubleshooting	567
Selecting the Desired Air Outlet.....	242	Switches		Blown Fuse.....	600, 601, 602, 603, 604
Service Reminder System.....	504	(Around the Steering Wheel)	6, 7, 8, 180	Brake Pedal Vibrates.....	35
Setting the Clock.....	150	Switching the Display	135	Buzzer Sounds When Opening Door.....	36
Shift Lever	27	System Updates	271	Emergency Towing.....	606
Operation	27			Noise When Braking.....	37
Releasing	590	T		Overheating	591
Won't Move	590	Tailgate	163	Power System Won't Start.....	583
Shifting (Transmission)	365	Temperature		Rear Door Won't Open.....	36, 162
Shoulder Anchorage.....	52	Outside Temperature Display	133	Shift Lever Won't Move.....	590
Side Airbags	66	Temperature Sensor	133	Warning Indicators.....	102
Side Curtain Airbags.....	68	Temporarily Repairing a Flat Tyre	569	Turn signals	
Sonar Sensors	470	Temporary Repair Kit (TRK).....	569	Indicators (Instrument Panel)	111
SOS Button	346	Tie-down Anchorages	225	Turning on the Power	359
SOS Cancel Button	346	Time (Setting)	150	Does Not Activate	583
Spark Plugs	610	Tools	568	If the 12-Volt Battery Is Dead.....	587
Specifications	610	Towing a Trailer	356	Tyres	541
Specified Fuel	495, 610	Towing Your Vehicle		Air Pressure	611
Speed & Time	141	Emergency	606	Checking and Maintaining	541
Speed Alarm.....	144	Traffic Sign Recognition System	134, 461	Inspection	541
Speed Limiter, Adjustable	376	Transmission	364, 365	Rotation	544
Speed Limiter, Intelligent.....	382	Creeping	364	Tyre Chains	545
Speedometer.....	132	Fluid	527	Wear Indicators.....	542
SRS Airbags (Airbags)	60	Kickdown	364	Winter.....	545
Steering Wheel	202	Number.....	612		
Adjusting.....	202				

U

Unlocking the Doors.....	154
Unlocking the Front Doors from the Inside.....	21
USB Flash Drives.....	287, 338
USB Ports.....	251

V

Vanity Mirrors.....	11
Vehicle Identification Numbers.....	612
Vehicle Stability Assist (VSA).....	389
OFF Button.....	390
OFF Indicator.....	110
System Indicator.....	110
Viscosity (Oil).....	520, 611
Voice Control Operation.....	255
Audio Commands.....	256
General Commands.....	256
List Commands.....	257
Navigation Commands.....	257
Phone Commands.....	256
Standard Commands.....	257
Voice Portal Screen.....	256
Voice Recognition.....	255
VSA (Vehicle Stability Assist).....	389

W

Wallpaper.....	267
Warning and Information Message.....	120

Warning Indicator On/Blinking.....	593
Warning Labels.....	99
Water Repellent Glass.....	561
Watts.....	610
Wear Indicators (Tyre).....	542
Wi-Fi Connection.....	294
Window Washers.....	196
Adding/Refilling Fluid.....	529
Switch.....	196
Windows (Opening and Closing).....	177
Windscreen.....	196
Cleaning.....	559, 561
Defrosting/Defogging.....	199, 239
Washer Fluid.....	529
Wiper Blades.....	536
Wipers and Washers.....	196
Winter Tyres.....	545
Tyre Chains.....	545
Wipers and Washers.....	196
Automatic Intermittent Wipers.....	197
Checking and Replacing Wiper Blades.....	536
Front.....	196
Rear.....	198
Wireless Charger.....	231
WMA.....	287
Worn Tyres.....	541