





As you read this manual, you will find Information that is preceded by a symbol **NOTICE**. This information is intended to help you avoid damage to your vehicle, other property, or the environment.

Symbols    on labels attached to your vehicle are to remind you to read this owner's manual for proper and safe operation of your vehicle.

  is colour-coded to indicate "danger" (red), "warning" (orange), or "caution" (amber).

 **Safety Labels** P. 95

A Few Words About Safety

Your safety, and the safety of others, is very important. And operating this vehicle safely is an important responsibility.

To help you make informed decisions about safety, we have provided operating procedures and other information on labels and in this manual. This information alerts you to potential hazards that could hurt you or others.

Of course, it is not practical or possible to warn you about all the hazards associated with operating or maintaining your vehicle. You must use your own good judgement.

You will find this important safety information in a variety of forms, including:

- **Safety Labels** - on the vehicle.
- **Safety Messages** - preceded by a safety alert symbol  and one of three signal words: **DANGER**, **WARNING**, or **CAUTION**. These signal words mean:

 **DANGER**

You WILL be KILLED or SERIOUSLY HURT if you don't follow instructions.

 **WARNING**

You CAN be KILLED or SERIOUSLY HURT if you don't follow instructions.

  **WARNING**

You CAN be KILLED or SERIOUSLY HURT if you don't follow instructions.

 **CAUTION**

You CAN be HURT if you don't follow instructions.

- **Safety Headings** - such as Important Safety Precautions.
- **Safety Section** - such as Safe Driving.
- **Instructions** - how to use this vehicle correctly and safely.

This entire book is filled with important safety information - please read it carefully.

Event Data Recorders

Your vehicle is equipped with several devices commonly referred to as Event Data Recorders. They record various types of real time vehicle data such as SRS airbag deployment and SRS system components failure.

This data belongs to the vehicle owner and may not be accessed by anyone else except as legally required or with the permission of the vehicle owner.

However this data may be accessed by Honda, its authorised dealers and authorised repairers, employees, representatives and contractors only for the purpose of the technical diagnosis, research and development of the vehicle.

Service Diagnostic Recorders

Your vehicle is equipped with service-related devices that record information about powertrain performance and driving conditions. The data can be used to help technicians diagnose, repair and maintain the vehicle. This data may not be accessed by anyone else except as legally required or with the permission of the vehicle owner.

However this data may be accessed by Honda, its authorised dealers and authorised repairers, employees, representatives and contractors only for the purpose of the technical diagnosis, research and development of the vehicle.

This owner's manual should be considered a permanent part of the vehicle and should remain with the vehicle when it is sold.

This owner's manual covers all models of your vehicle. You may find descriptions of equipment and features that are not on your particular model.

Images throughout this owner's manual represent features and equipment that are available on some, but not all, models. Your particular model may not have some of these features.

The information and specifications included in this publication were in effect at the time of approval for printing. Honda Motor Co., Ltd. reserves the right, however, to discontinue or change specifications or design at any time without notice and without incurring any obligation.

Although this manual is applicable to both right-hand and left-hand drive models, the illustrations contained in this manual mainly refer to the left-hand drive models.

➤ Safe Driving P. 37

For Safe Driving P. 38 Seat Belts P. 43 Airbags P. 56

➤ Instrument Panel P. 97

Indicators P. 98 Gauges and Driver Information Interface P. 147

➤ Controls P. 175

Clock P. 176 Locking and Unlocking the Doors P. 179
Panoramic Roof* P. 213
Adjusting the Seats P. 249 Interior Lights/Interior Convenience Items P. 268

➤ Features P. 297

Audio System P. 298 Audio System Basic Operation P. 305, 332
Customized Features P. 405, 413

➤ Driving P. 499

Before Driving P. 500 Towing a Trailer P. 504 Off-road Guidelines P. 512
Multi-View Rear Camera* P. 651 Refueling P. 653

➤ Maintenance P. 657

Before Performing Maintenance P. 658 Service Reminder System* P. 662
Replacing Light Bulbs P. 694
Battery P. 712 Remote Transmitter Care P. 718
Accessories and Modifications P. 728

➤ Handling the Unexpected P. 731

Tools P. 732 If a Tyre Goes Flat P. 734
Overheating P. 749 Indicator, Coming On/Blinking P. 751

➤ Information P. 769

Specifications P. 770 Identification Numbers P. 773

Contents

Child Safety P. 70

Exhaust Gas Hazard P. 94

Safety Labels P. 95

Opening and Closing the Tailgate P. 192
Operating the Switches Around the Steering Wheel P. 217
Climate Control System P. 290

Security System P. 204

Opening and Closing the Windows P. 210
Adjusting the Mirrors P. 245

Audio Error Messages P. 398
Hands-Free Telephone System P. 441, 462

General Information on the Audio System P. 400
Emergency Call (eCall)* P. 493

When Driving P. 514
Fuel Economy and CO₂ Emissions P. 655

Honda Sensing P. 558

Braking P. 629

Parking Your Vehicle P. 640

Turbo Engine Vehicle P. 656

Oil Monitor System* P. 667
Checking and Maintaining Wiper Blades P. 702
Climate Control System Maintenance P. 720

Maintenance Schedule* P. 672
Checking and Maintaining Tyres P. 707
Cleaning P. 723

Maintenance Under the Bonnet P. 680

Engine Does Not Start P. 743
Fuses P. 758

Jump Starting P. 746
Emergency Towing P. 765

Shift Lever Does Not Move* P. 748
When You Cannot Open the Tailgate P. 766

Devices that Emit Radio Waves P. 774

EC Declaration of Conformity Content Outline* P. 806

Quick Reference Guide P. 4

Safe Driving P. 37

Instrument Panel P. 97

Controls P. 175

Features P. 297

Driving P. 499

Maintenance P. 657

Handling the Unexpected P. 731

Information P. 769

Index P. 810

Visual Index

Left-hand Drive Type

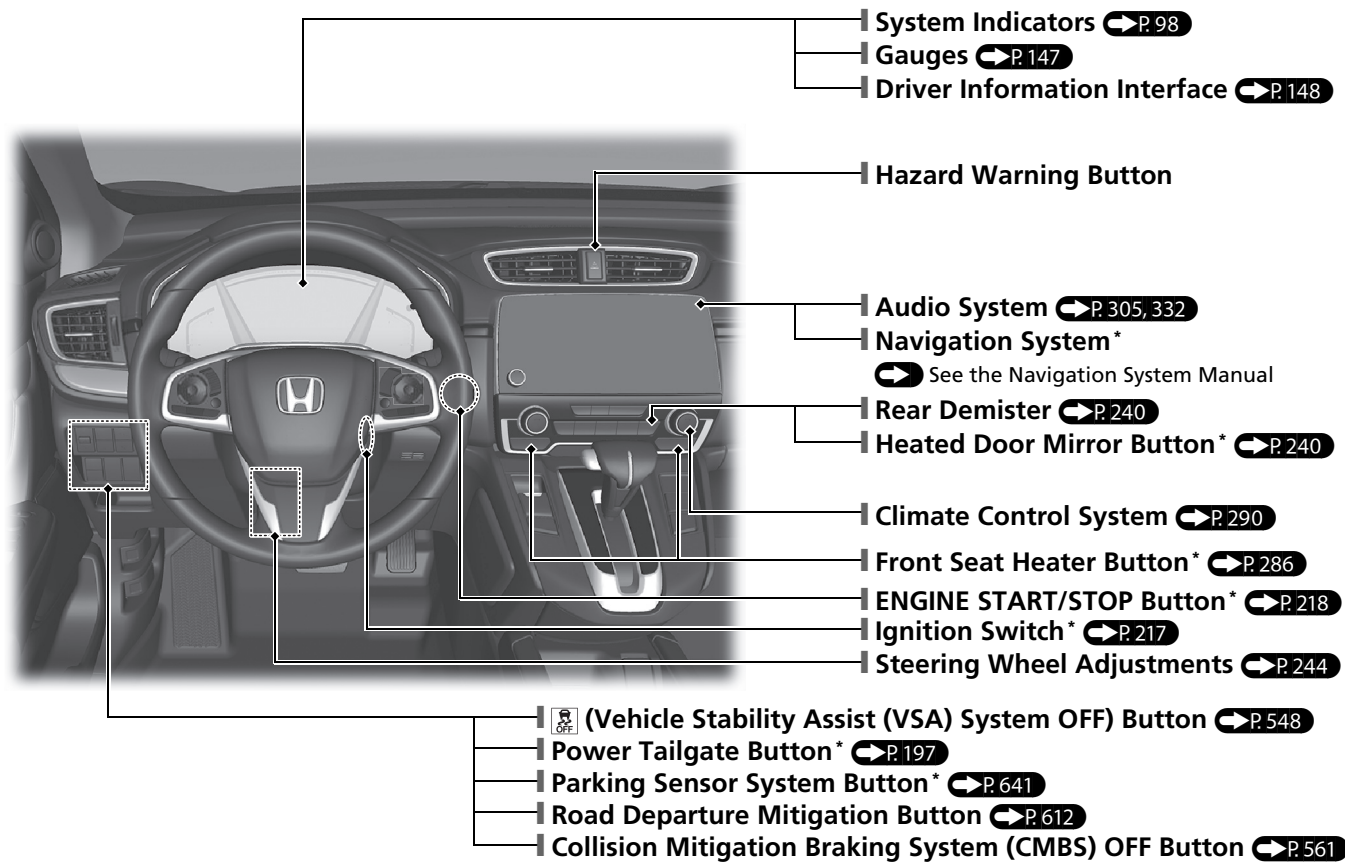

Right-hand Drive Type

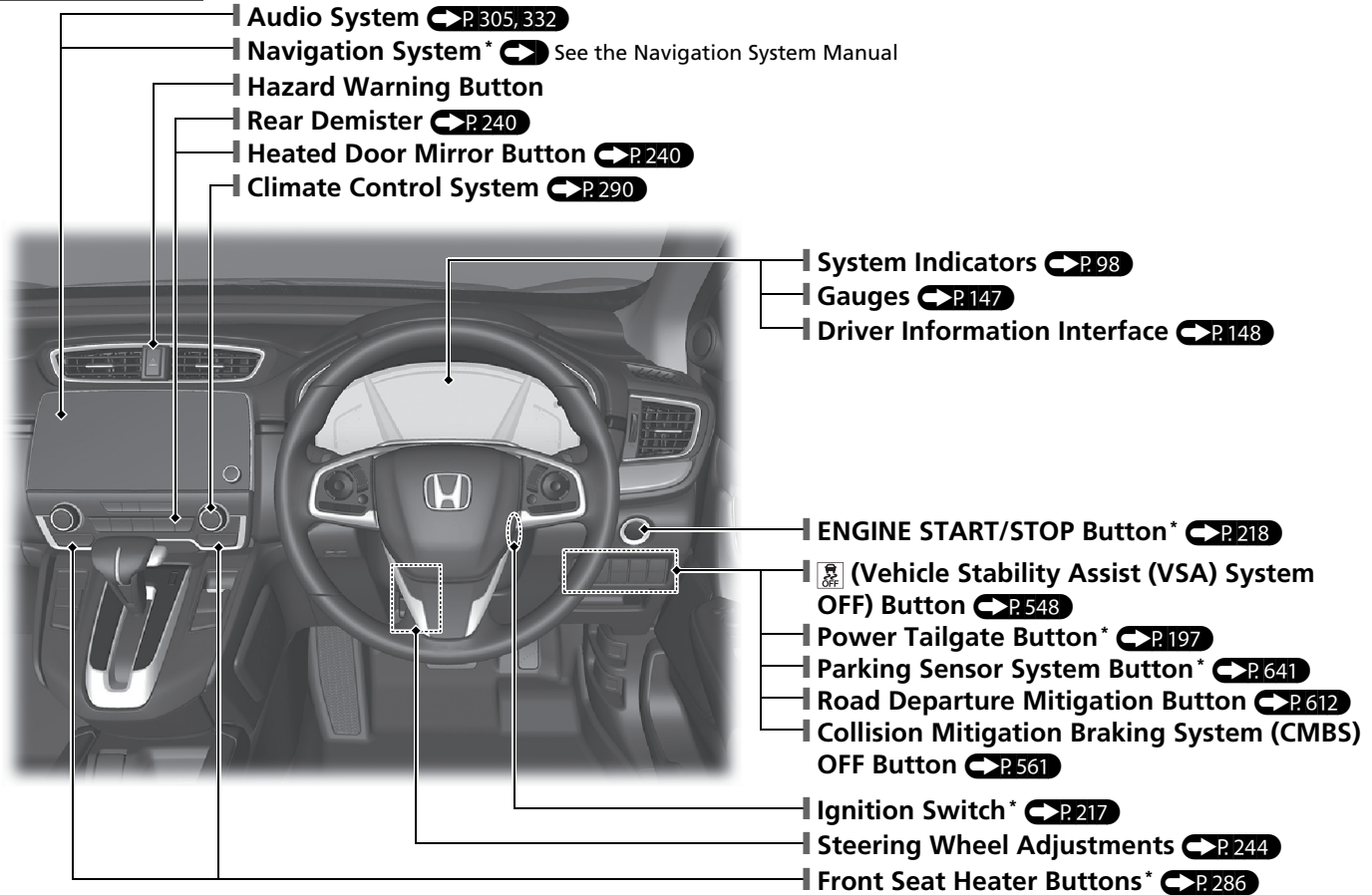

* Not available on all models

Visual Index

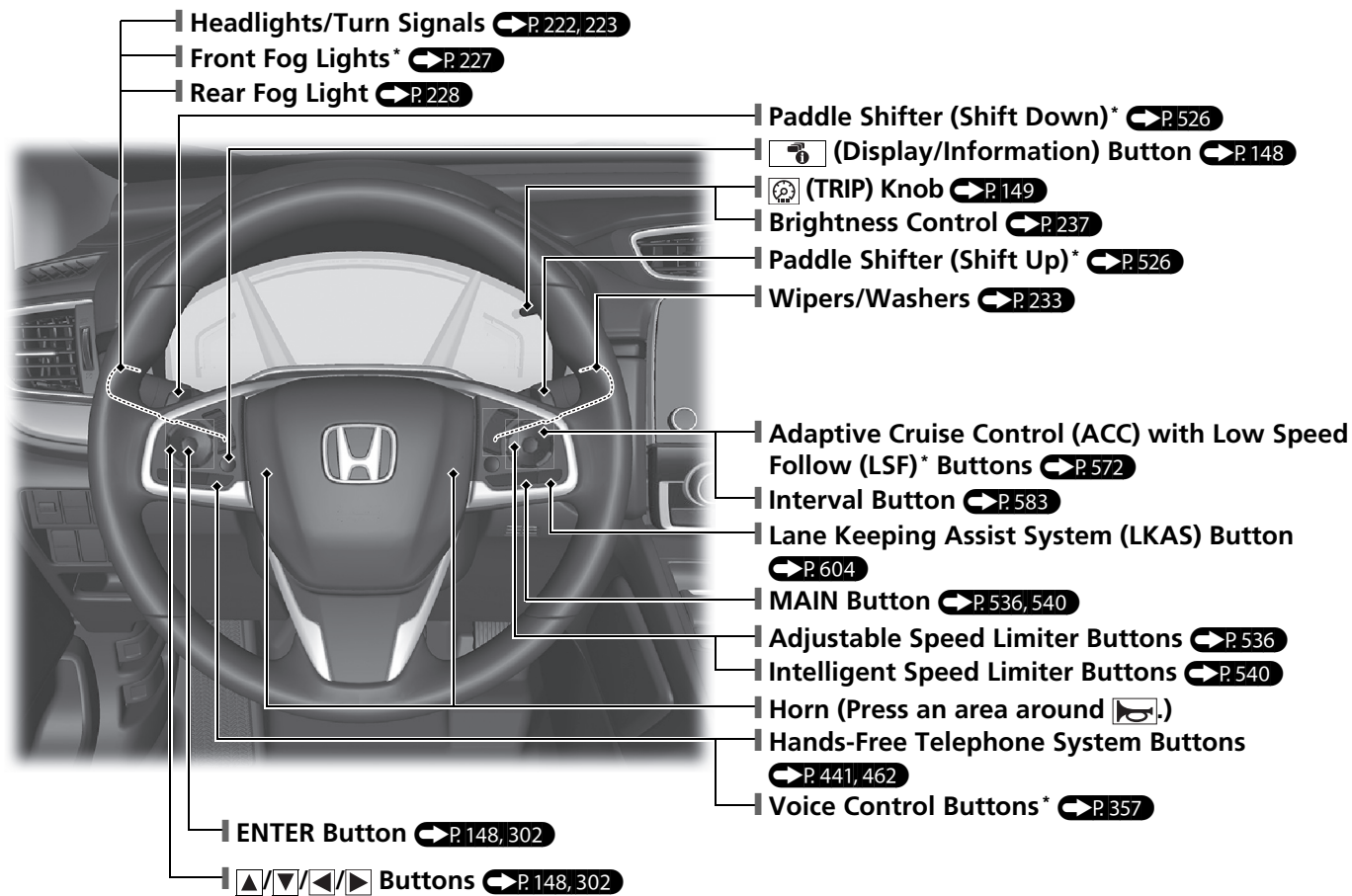

Left-hand Drive Type

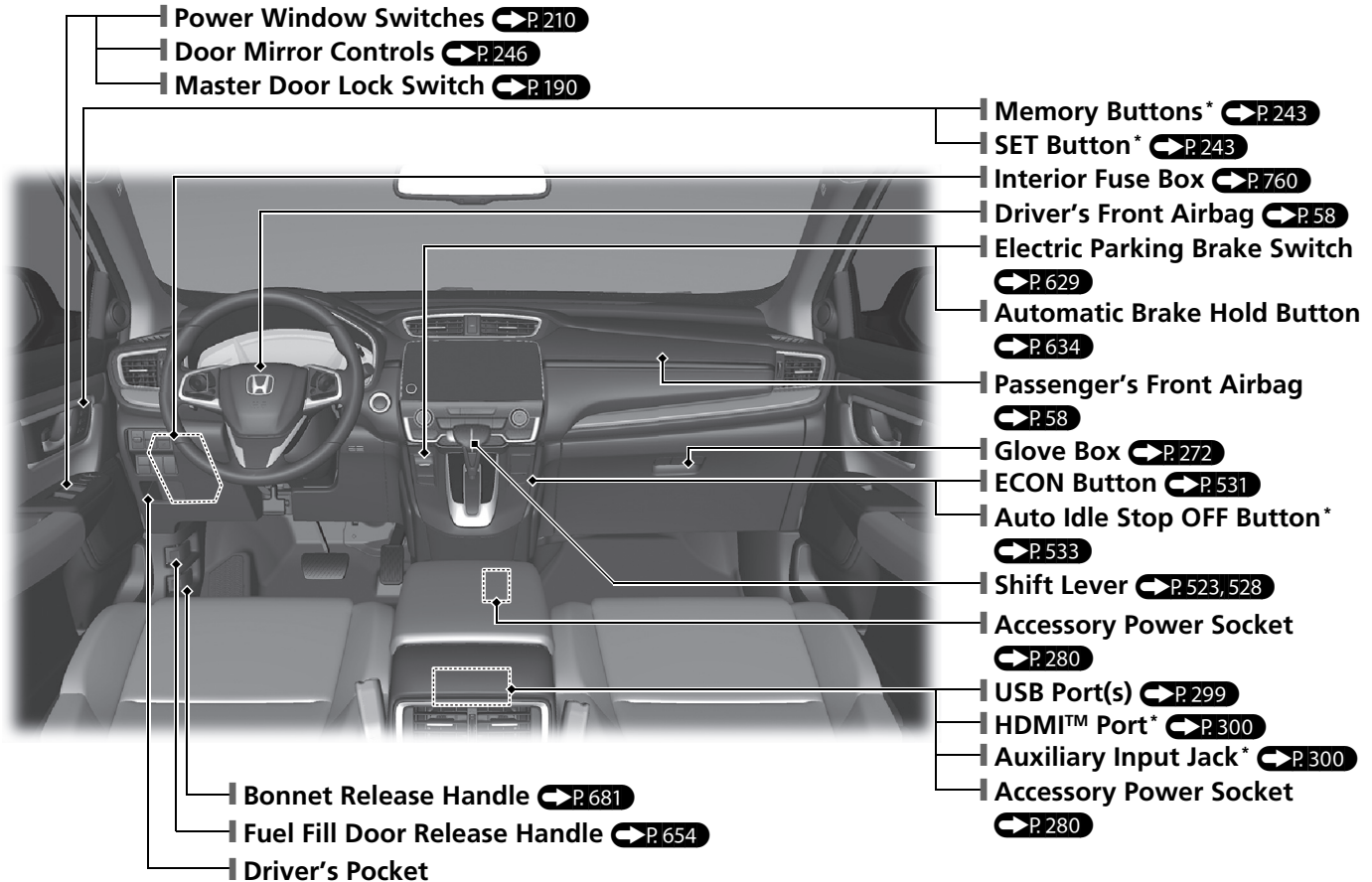

* Not available on all models

Visual Index

Right-hand Drive Type

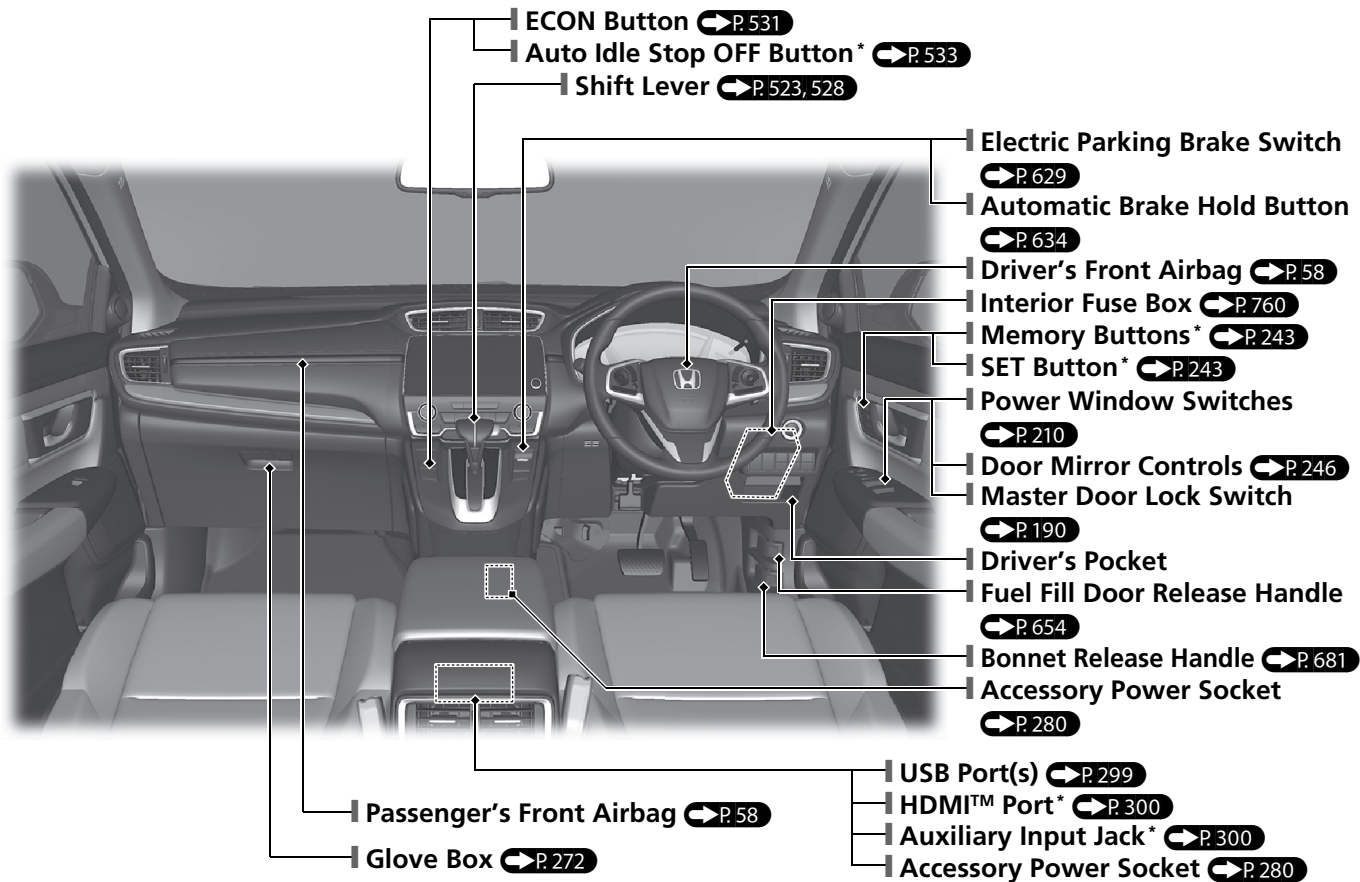

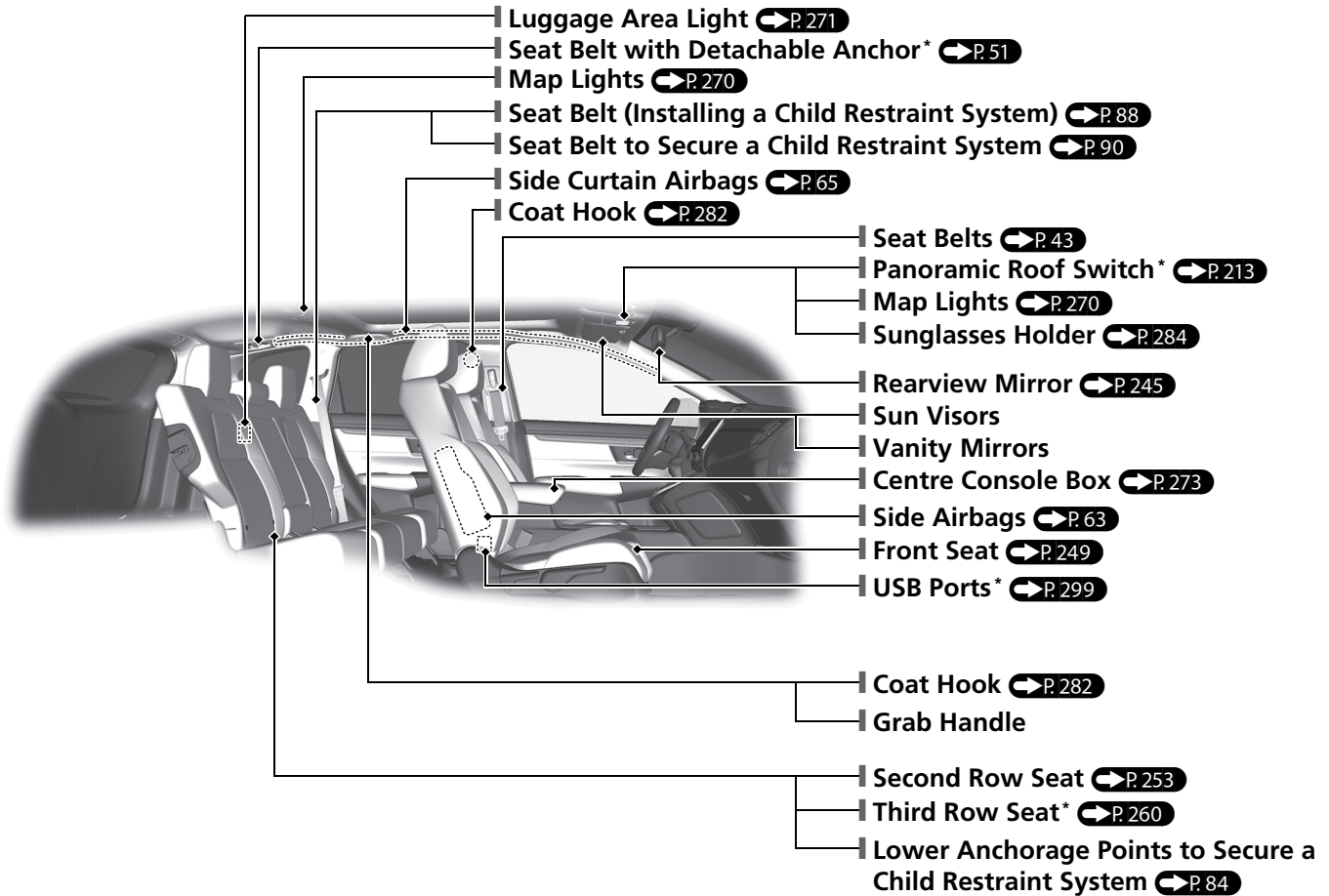

* Not available on all models

Visual Index

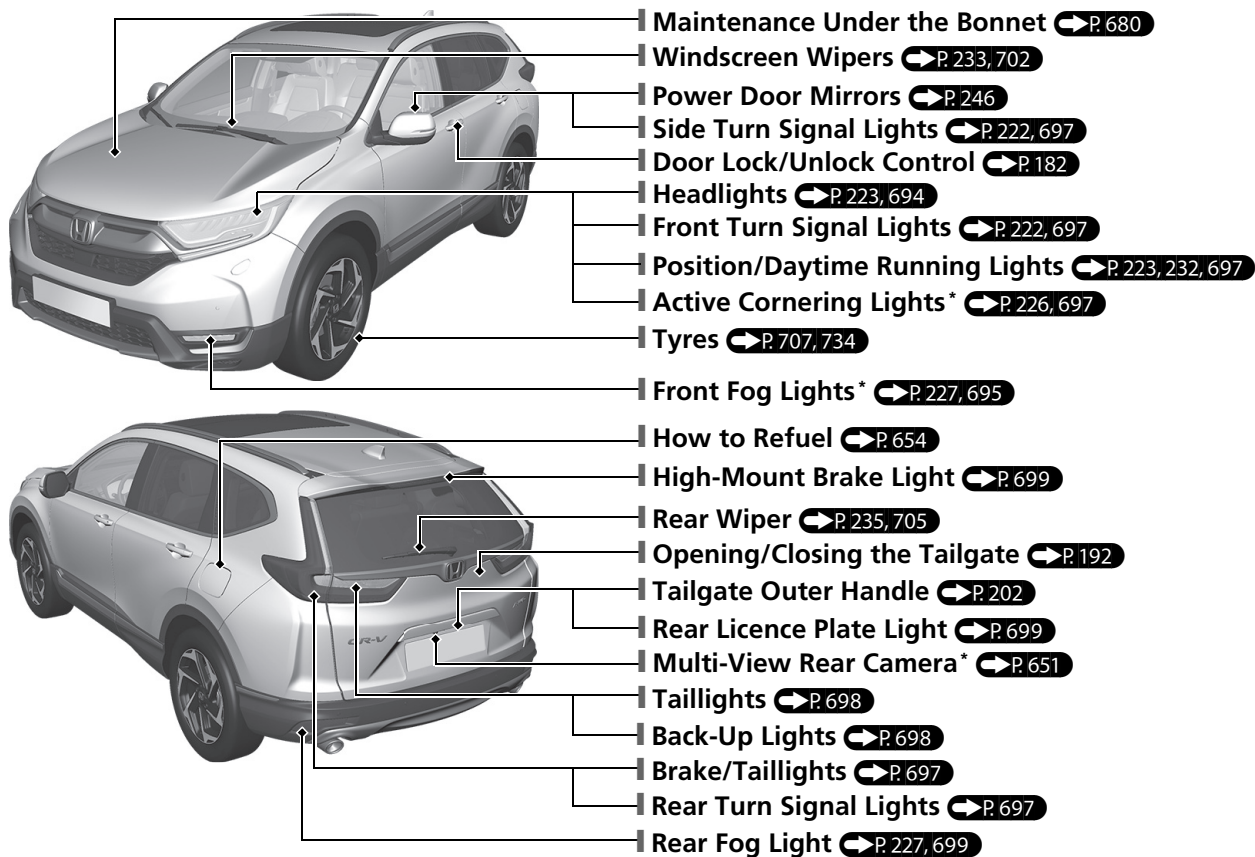

Eco Assist System

Ambient Meter

- The colour of the ambient meter changes to green to indicate that the vehicle is being driven in a fuel efficient manner.

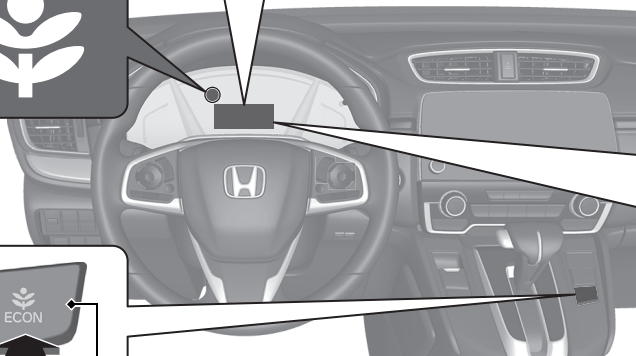

ECON Button [▶ P.531](#)

Helps to maximise fuel economy.

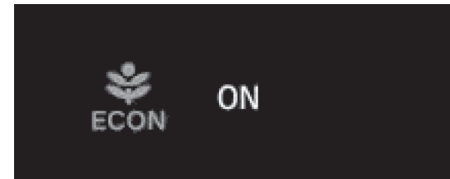





The message is displayed for a few seconds when the ECON button is pressed.

ECON Mode Indicator [▶ P.111](#)

Comes on when the **ECON** button is pressed.

Auto Idle Stop Function*

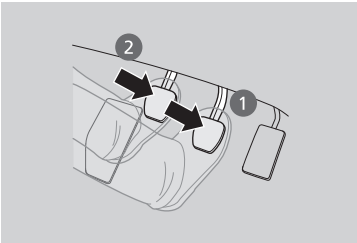
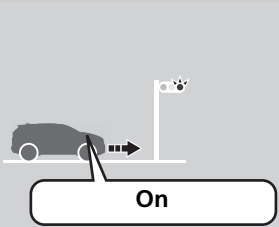
To improve fuel economy, the engine stops and then restarts as detailed below. When Auto Idle Stop is on, the Auto Idle Stop indicator (green) comes on. 

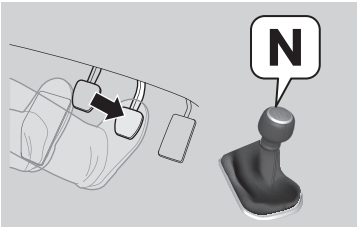
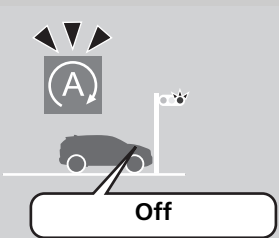
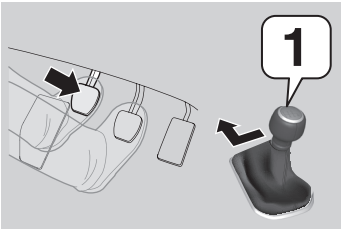
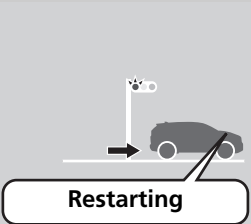
At	Manual transmission	Engine status
 Deceleration	<ol style="list-style-type: none">1. Depress the brake pedal.2. Fully depress the clutch pedal. 	
 Stop	<ul style="list-style-type: none">• Continue to depress the brake pedal.• Move the shift lever to N.• Release the clutch pedal. 	
Start-up	<ol style="list-style-type: none">1. Depress the clutch pedal again.2. Move the shift lever to 1.3. Depress the accelerator pedal to resume driving. 	

Safe Driving P. 37

Airbags P. 56

- Your vehicle is fitted with airbags to help to protect you and your passengers during a moderate-to-severe collision.

Child Safety P. 70

- All children 12 and younger should be seated in the rear seat.
- Small children should be properly restrained in a front facing child restraint system.
- Infants must be properly restrained in a rear-facing child restraint system on a rear seat.

Exhaust Gas Hazard P. 94

- Your vehicle emits dangerous exhaust gases that contain carbon monoxide. Do not run the engine in confined spaces where carbon monoxide gas can accumulate.

Seat Belts P. 43

- Fasten your seat belt and sit upright well back in the seat.
- Check that your passengers are wearing their seat belts correctly.



Fasten your lap belt as low as possible.

Before Driving Checklist P. 42



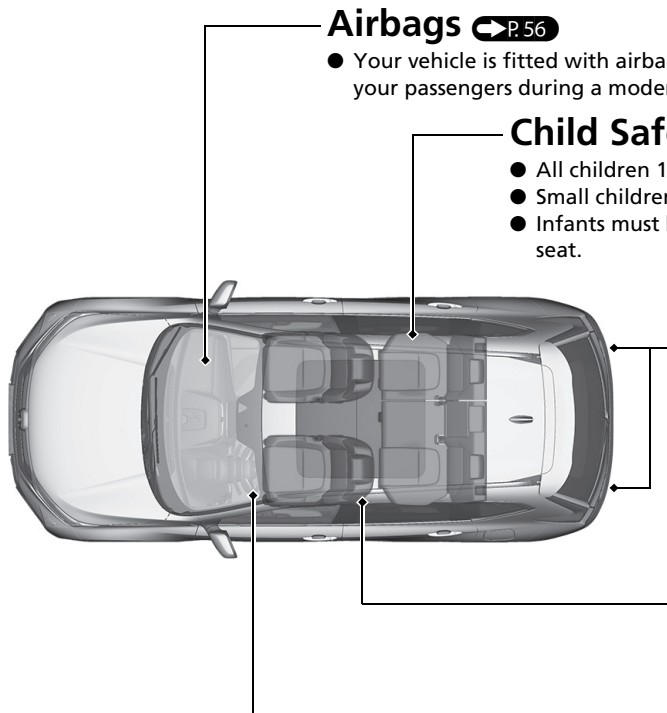











- Before driving, check that the front seats, head restraints, steering wheel, and mirrors have been properly adjusted.



Instrument Panel P.97

Gauges  P.147 / Driver Information Interface  P.148 / Head-up Display*  P.170 / System Indicators  P.98

System Indicators



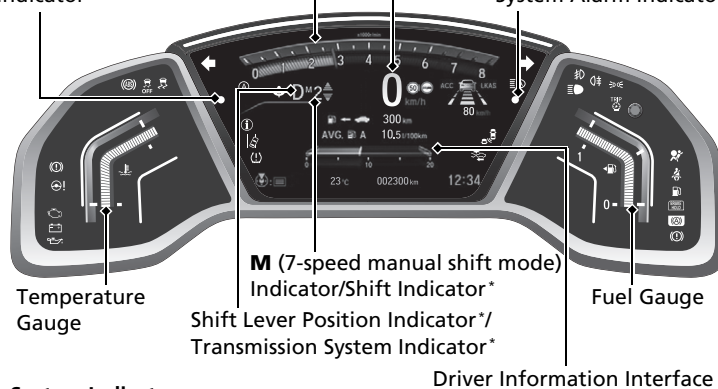

-  Malfunction Indicator Lamp
-  Low Oil Pressure Indicator
-  Charging System Indicator
-  Anti-lock Brake System (ABS) Indicator
-  Vehicle Stability Assist (VSA) System Indicator
-  VSA OFF Indicator
-  Automatic Brake Hold System Indicator
-  Automatic Brake Hold Indicator
-  ECON Mode Indicator
-  Parking Brake and Brake System Indicator (Red)
-  Parking Brake and Brake System Indicator (Amber)
-  System Message Indicator
-  Low Tyre Pressure/Deflation Warning System Indicator
-  Blind spot information System Indicator*

Right-hand Drive Type





Immobilizer System Indicator/
Security System Alarm
Indicator











System Indicators

-  Turn Signal and Hazard Warning Indicators
-  Electric Power Steering (EPS) System Indicator
-  Low Fuel Indicator
-  Seat Belt Reminder Indicator
-  Supplemental Restraint System Indicator

Lights Indicators

-  Lights On Indicator
-  High Beam Indicator
-  Front Fog Light Indicator*
-  Rear Fog Light Indicator

System Indicators

-  Adjustable Speed Limiter Indicator
-  Intelligent Speed Limiter Indicator
-  Auto Idle Stop System Indicator (Amber)* / Auto Idle Stop Indicator (Green)*
-  Auto High-Beam Indicator
-  Adaptive Cruise Control (ACC) with Low Speed Follow (LSF)* Indicator (Amber/Green)
-  Lane Keeping Assist System (LKAS) Indicator (Amber/Green)
-  Collision Mitigation Braking System (CMBS) Indicator
-  Road Departure Mitigation Indicator

Controls P.175





Clock P.176

Models with navigation system



The audio system receives signals from GPS satellites, updating the clock automatically.

Models with colour audio system





- 1 Press and hold the **MENU/CLOCK** button.
- 2 Rotate  to change hour, then press .
- 3 Rotate  to change minute, then press .
- 4 Select **SET**, then press .

These indications are used to show how to operate the selector knob.

- Rotate  to select.
- Press  to enter.





Models with Display Audio

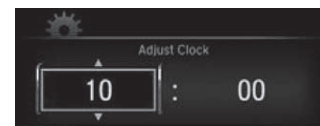

- 1 Select the  (HOME) icon, then select **Settings**.
- 2 Select **Clock**, then **Clock Adjustment**.
- 3 Touch the respective  icon to adjust the hours or minutes up or down.
- 4 Select **OK**.

Models with colour audio system



- 1 Press the  button to select , then press the **ENTER** button.
- 2 Press the  button until **Clock Setup** appears on the display.
- 3 Press the **ENTER** button.
- 4 Press the **ENTER** button to select **Adjust Clock**.
- 5 Press the  button to change hour, then press the **ENTER** button.
- 6 Press the  button to change minute, then press the **ENTER** button.

ENGINE START/STOP Button* P. 218

Press the button to change the vehicle's power mode.

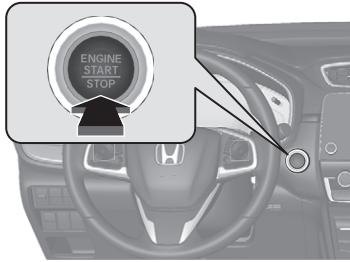

Turn Signals P. 222

Turn Signal Control Lever

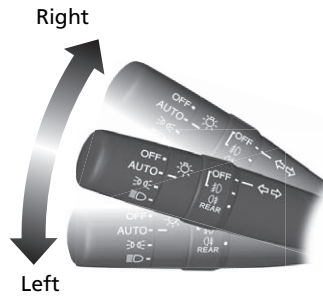

Lights P. 223

Light Control Switches

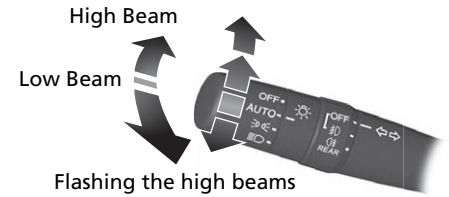

Wipers and Washers

➔ P.233

Wiper/Washer Control Lever

MIST
OFF

AUTO*1: Wiper speed varies automatically

INT*2: Low speed with intermittent

LO: Low speed wipe

HI: High speed wipe

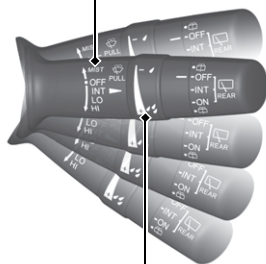

Pull toward you to spray washer fluid.

Adjustment Ring

[-]: Low Sensitivity*1

[-] ♣: Lower speed, fewer sweeps*2

[+]: High Sensitivity*1

[+] ♣: Higher speed, more sweeps*2

Models with automatic intermittent wipers

AUTO should always be turned **OFF** before the following situations in order to prevent severe damage to the wiper system:

- Cleaning the windscreen
- Driving through a car wash
- No rain present

Steering Wheel ➔ P.244

- To adjust, pull the adjustment lever towards you, adjust to the desired position, then lock the lever back in place.

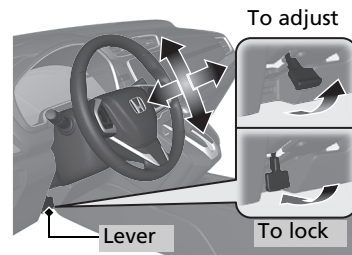

Unlocking the Front Doors from the Inside

➔ P.189

- Pull either front door inner handle to unlock and open it at the same time.

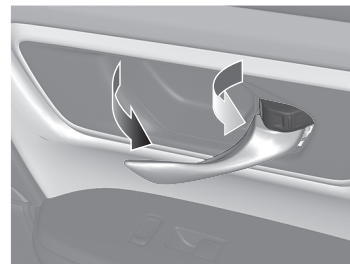

*1: Models with automatic intermittent wipers

*2: Models without automatic intermittent wipers

Tailgate P.192



Models with power tailgate

Use a forward and back kicking motion under the centre of the rear bumper to open or close the power tailgate while carrying the keyless remote.

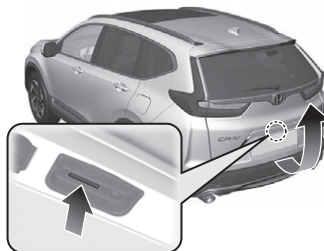
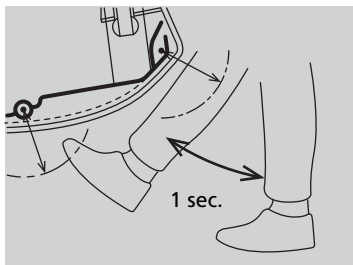

Models without keyless access system

- With all the doors unlocked, press the outer handle and lift open the tailgate.

Models with keyless access system

- Press the outer handle to unlock and open the tailgate when you have the keyless remote on you.

Models with power tailgate

- Press the power tailgate button on the driver side control panel, or press the remote transmitter.

Power Door Mirrors

P.246

- With the ignition switch in ON *1, move the selector switch to L or R.
- Push the appropriate edge of the adjustment switch to adjust the mirror.
- Press the folding button to fold in and out the door mirrors.

Folding Button

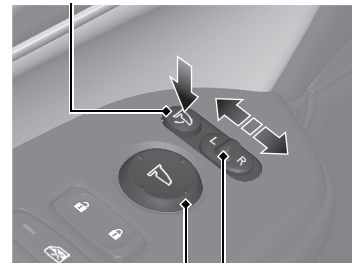

Adjustment Switch

Selector Switch

*1 : Models with the keyless access system have an **ENGINE START/STOP** button instead of an ignition switch.

Power Windows P. 210

- With the ignition switch in ON *1, open and close the power windows.
- If the power window lock button is in the off position, each passenger's window can be opened and closed with its own switch.
- If the power window lock button is in the on position (indicator on), each passenger's window switch is disabled.

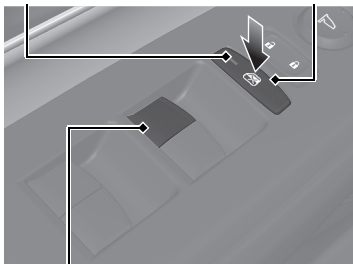

Indicator Power Window Lock Button



Window Switch

*1: Models with the keyless access system have an **ENGINE START/STOP** button instead of an ignition switch.

Climate Control System P.290

- Press the **AUTO** button to activate the climate control system.
- Press the  button to turn the system on or off.
- Press the  button to defrost the windscreen.

Models with colour audio system

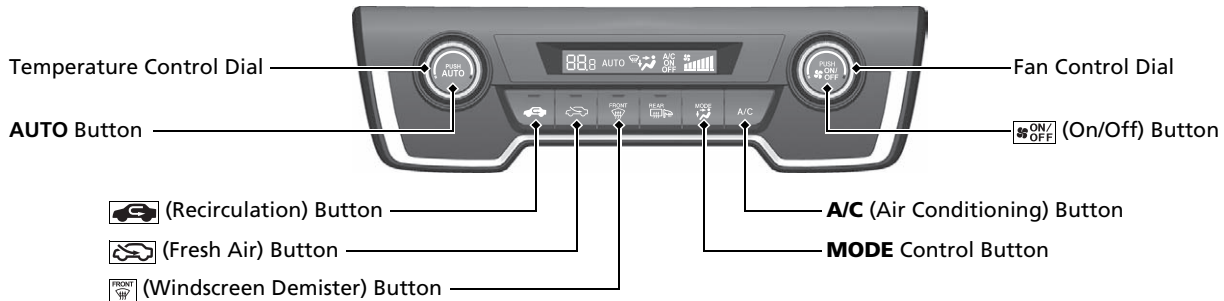
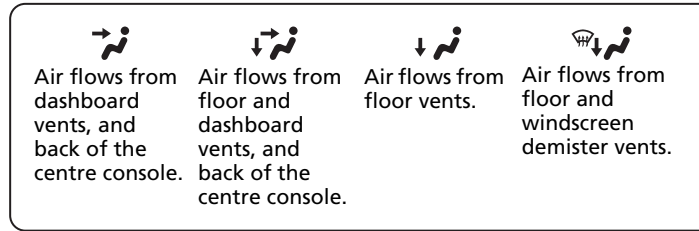

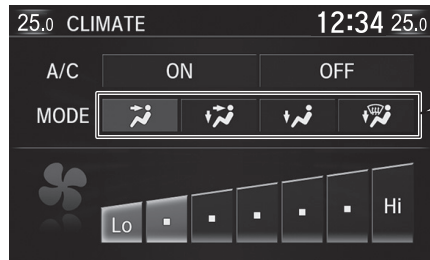

Air flows from dashboard vents, and back of the centre console.	Air flows from floor and dashboard vents, and back of the centre console.	Air flows from floor vents.	Air flows from floor and windscreen demister vents.

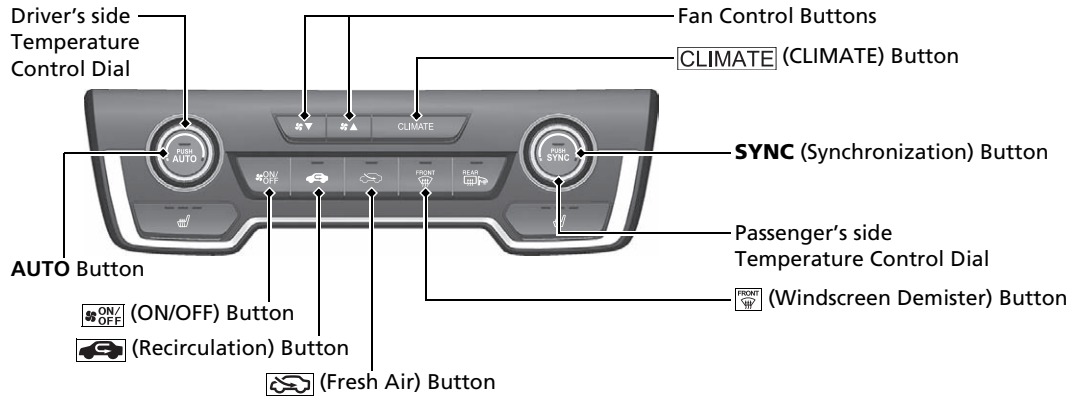

Features ➔ P.297

Audio Remote Controls

➔ P.302

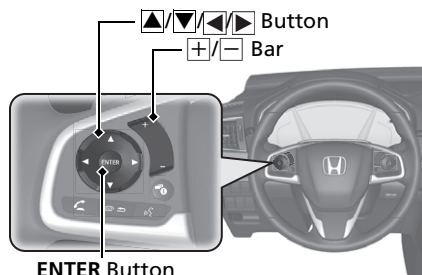

ENTER Button

- **+**/**-** Bar
Press to adjust the volume up/down.
- **▲/▼** Button
Press **▲** or **▼** to cycle through the audio mode as follows:

Models with colour audio system

FM1/FM2/DAB1/DAB2/LW/MW/USB or iPod/*Bluetooth*[®] Audio/AUX

Models with Display Audio

FM/DAB/LW/MW/USB/iPod/*Bluetooth*[®] Audio/Apps/Audio Apps/AUX-HDMI™

Models with Display Audio

- **ENTER** Button
- When listening to the radio
 - 1 Press **ENTER** to switch the display to a preset list you stored in the preset buttons.
 - 2 Press **▲** or **▼** to select a preset, then press **ENTER**.
- When listening to a USB flash drive
 - 1 Press **ENTER** to display the folder list.
 - 2 Press **▲** or **▼** to select a folder.
 - 3 Press **ENTER** to display a list of tracks in that folder.
 - 4 Press **▲** or **▼** to select a track, then press **ENTER**.

- When listening to an iPod

- 1 Press **ENTER** to display the iPod music list.
 - 2 Press **▲** or **▼** to select a category.
 - 3 Press **ENTER** to display a list of items in the category.
 - 4 Press **▲** or **▼** to select an item, then press **ENTER**.
 - ▶ Press **ENTER** and press **▲** or **▼** repeatedly until a desired item you want to listen is displayed.
- When listening to *Bluetooth*[®] Audio
 - 1 Press **ENTER** to display the track list.
 - 2 Press **▲** or **▼** to select a track, then press **ENTER**.

-  Button

Radio: Press to change the preset station.
Press and hold to select the next or previous strong station.



USB device:

Press to skip to the beginning of the next song or return to the beginning of the current song.
Press and hold to change a folder.



(Display/Information) Button:

Press to change contents.

 **Driver Information Interface**  P. 148

Audio system P.298

Models with colour audio system  P.305

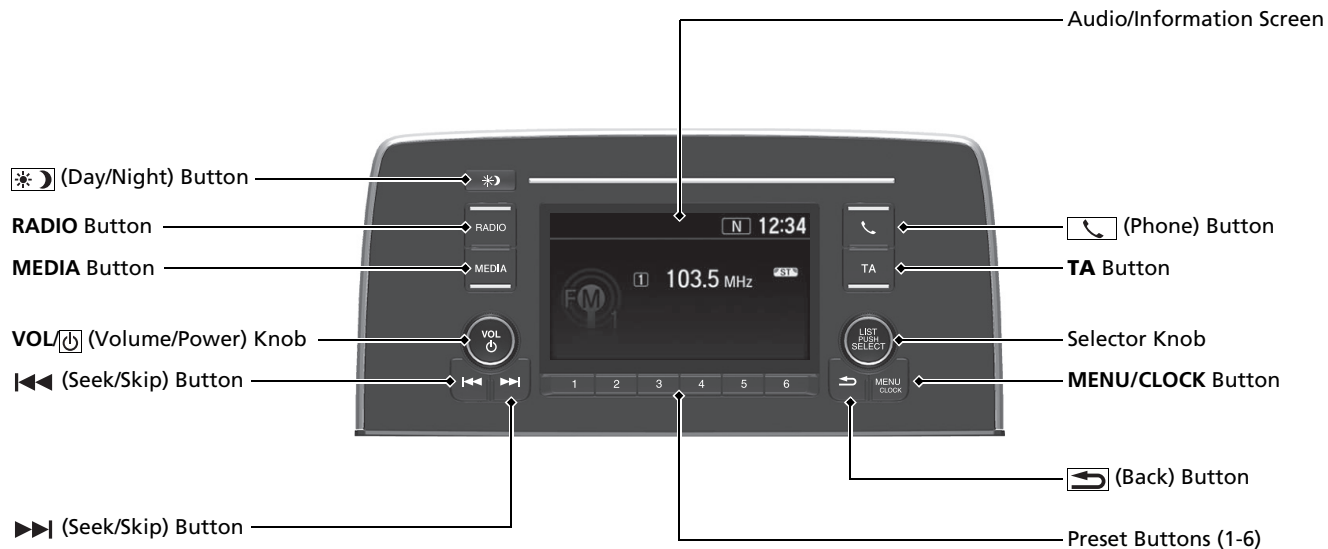

For navigation system operation See the Navigation System Manual

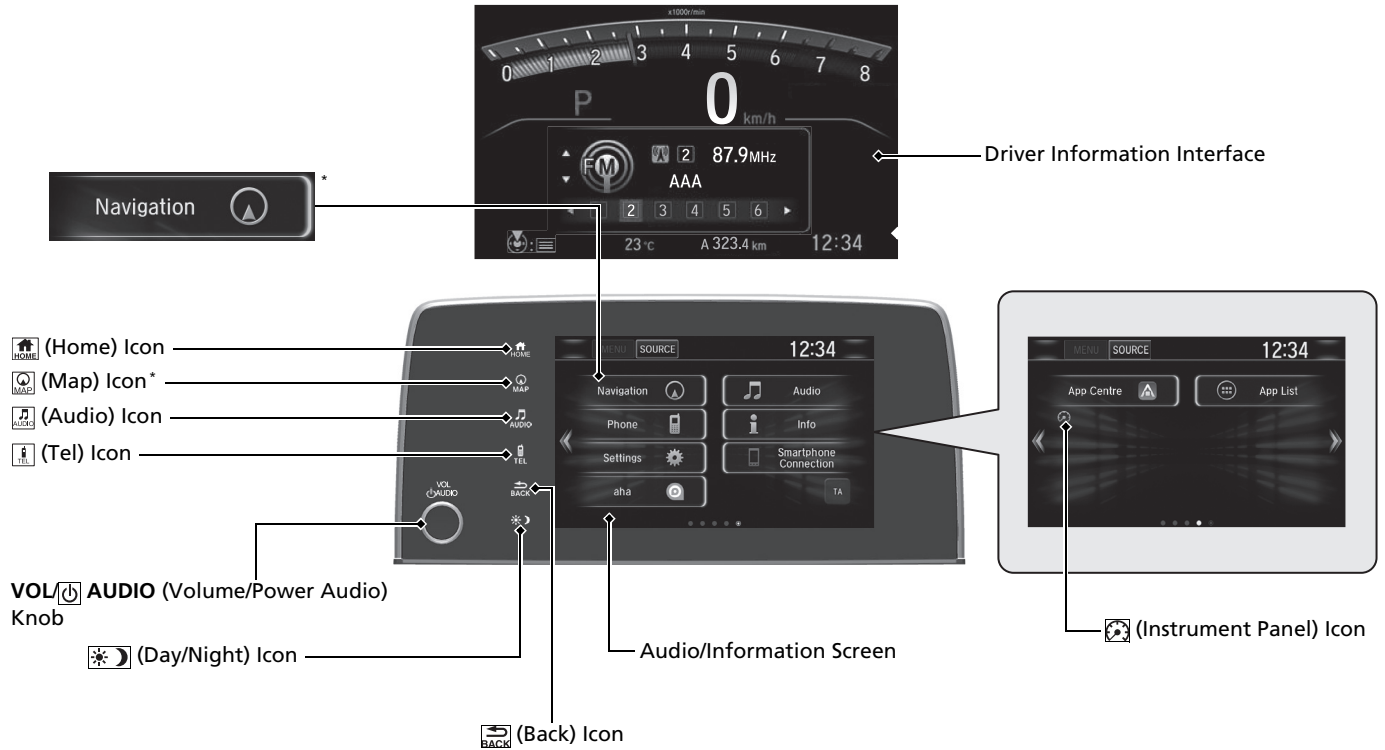

Driving ➔ P.499

Manual Transmission* ➔ P.528

Continuously Variable Transmission*

➔ P.523

- Shift to **P** and depress the brake pedal when starting the engine.

Shifting

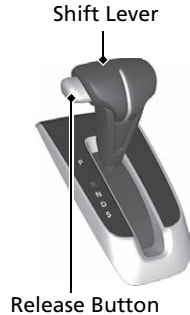
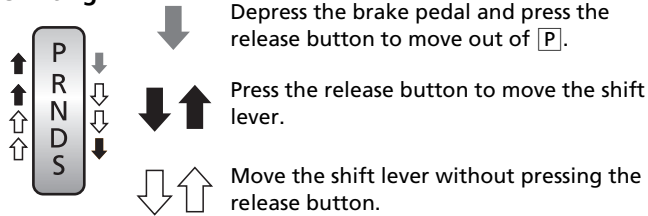

- P** **Park**
Turn off or start the engine. Transmission is locked.
- R** **Reverse**
Used when reversing.
- N** **Neutral**
Transmission is not locked.
- D** **Drive**
- Normal driving.
 - 7-speed manual shift mode can be used temporarily.
- S** **Drive (S)**
- Better acceleration
 - Used to increase engine braking
 - Used when going up or down hills
 - 7-speed manual shift mode can be used.

7-Speed Manual Shift Mode ➔ P.525

Allows you to manually shift the transmission up or down without removing your hands from the steering wheel.

When the shift lever is in **S**

- Pulling a paddle shifter changes the mode from continuously variable transmission to 7-speed manual shift mode.
- The **M** indicator and the selected speed number are displayed in the shift indicator.

When the shift lever is in **D**

- Pulling a paddle shifter temporarily changes the mode from continuously variable transmission to 7-speed manual shift mode. The selected speed number is displayed in the shift indicator.

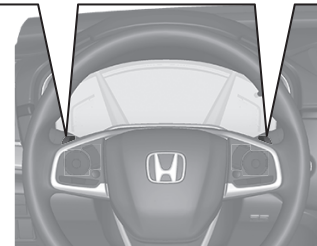
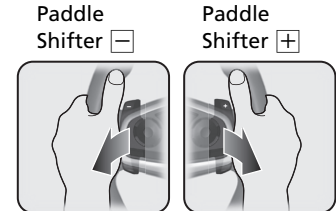
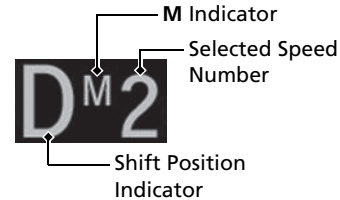

Adjustable Speed Limiter

➔ P.536

- This system enables you to set a maximum speed that cannot be exceeded even if you are depressing the accelerator pedal.
- To use the adjustable speed limiter, press the **MAIN** button. Select the adjustable speed limiter by pressing the **LIM** button, then press the **-/SET** when your vehicle reaches the desired speed.
- The vehicle speed limit can be set from 30 km/h (18 mph) to 250 km/h (156 mph).

VSA On and Off ➔ P.548

- The Vehicle Stability Assist (VSA) system helps stabilise the vehicle during cornering, and helps maintain traction while accelerating on loose or slippery road surfaces.
- VSA comes on automatically every time you start the engine.
- To partially disable or fully restore VSA function, press and hold the button until you hear a beep.

Deflation Warning System ➔ P.551

- Detects a change in tyre conditions and overall dimensions due to decrease in tyre pressures.
- Deflation warning system is turned on automatically every time you start the engine.
- A initialisation procedure must be performed when certain conditions arise.

CMBS On and Off ➔ P.565

- When a possible collision is likely unavoidable, the CMBS can help you to reduce the vehicle speed and the severity of the collision.
- The CMBS is turned on every time you start the engine.
- To turn the CMBS on or off, press and hold the button until you hear a beep.

Refueling P.653

Fuel recommendation: EN 228 standards petrol/gasohol fuel
Unleaded premium petrol/gasohol up to E10 (90% petrol and 10% ethanol), research octane number 95 or higher

Fuel tank capacity: 57 L

- 1 Pull the fuel fill door release handle.

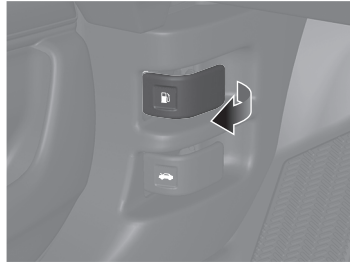

- 2 Turn the fuel fill cap slowly to remove the cap.



- 3 Place the cap in the holder on the fuel fill door.

- 4 After refueling, screw the cap back on until it clicks at least once.



Honda Sensing

➔ P. 558

Honda Sensing is a driver support system which employs the use of two distinctly different kinds of sensors, a radar sensor located in the front grille and a front sensor camera mounted to the interior side of the windscreen, behind the rearview mirror.

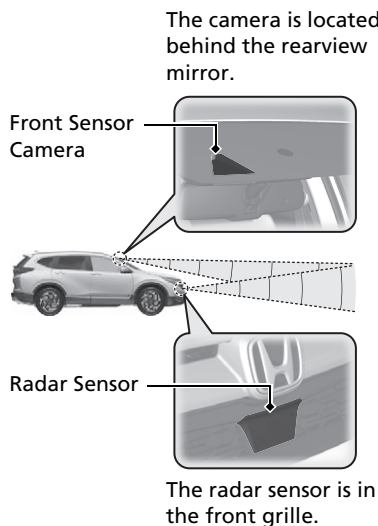

Collision Mitigation Braking System (CMBS)

➔ P. 561

Can assist you when there is a possibility of your vehicle colliding with a vehicle or a pedestrian detected in front of yours. The CMBS is designed to alert you when a potential collision is determined, as well as to reduce your vehicle speed to help minimise collision severity when a collision is deemed unavoidable.

Adaptive Cruise Control (ACC) with Low Speed Follow (LSF)*

➔ P. 572

Helps to maintain a constant vehicle speed and a set following interval behind a vehicle detected ahead of yours and, if the detected vehicle comes to a stop, can decelerate and stop your vehicle, without you having to keep your foot on the brake or the accelerator.

Adaptive Cruise Control (ACC)*

➔ P. 589

Helps to maintain a constant vehicle speed and a set following interval behind a vehicle detected ahead of yours, without you having to keep your foot on the brake or the accelerator.

Lane Keeping Assist System (LKAS)

➔ P. 604

Provides steering input to help keep the vehicle in the middle of a detected lane and provides tactile and visual alerts if the vehicle is detected drifting out of its lane.

Road Departure Mitigation System

➔ P. 612

Alerts and helps to assist you when the system detects a possibility of your vehicle unintentionally crossing over detected lane markings and/or leaving the roadway altogether.

Traffic Sign Recognition System

➔ P. 618

Reminds you of road sign information, such as the current speed limit and that overtaking is prohibited, your vehicle has just passed through, showing it on the driver information interface and the head-up display*.

Maintenance P.657

Under the Bonnet P.680

- Check engine oil, engine coolant, and windscreen washer fluid. Add when necessary.
- Check brake fluid.
- Check the battery condition monthly.

- 1 Pull the bonnet release handle under the driver's side lower outside corner of the dashboard.

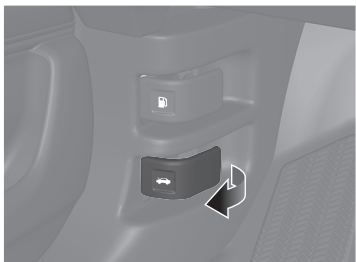

- 2 Locate the bonnet latch lever, push it to the side, and then raise the bonnet. Once you have raised the bonnet slightly, you can release the lever.



- 3 When finished, close the bonnet and make sure it is firmly locked in place.

Wiper Blades P.702

- Replace blades if they leave streaks across the windscreen.

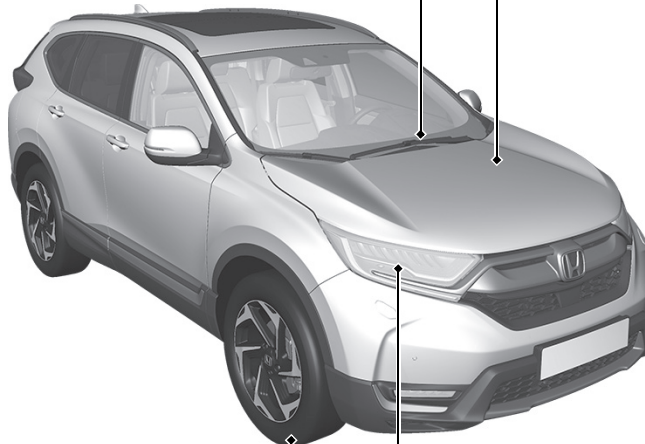

Tyres P.707

- Inspect tyres and wheels regularly.
- Check tyre pressures regularly.
- Install winter tyres for winter driving.

Lights P.694

- Inspect all lights regularly.

Handling the Unexpected P.731

Flat Tyre P.734

- Park in a safe location and replace the flat tyre with the compact spare tyre in the luggage area.



Engine Won't Start P.743

- If the battery is dead, jump start using a booster battery.

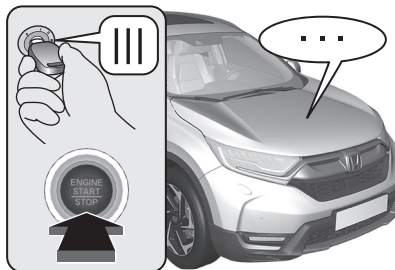

Overheating P.749

- Park in a safe location. If you do not see steam under the bonnet, open the bonnet, and let the engine cool down.



Indicators Come On

P.751

- Identify the indicator and consult the owner's manual.

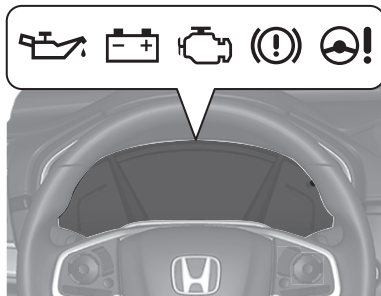

Blown Fuse P.758

- Check for a blown fuse if an electrical device does not operate.

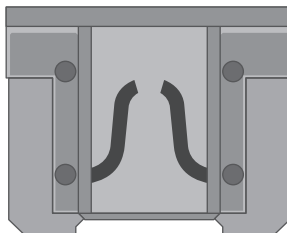

Emergency Towing P.765

- Call a professional towing service if you need to tow your vehicle.



What to Do If



Models without keyless access system

The ignition switch does not turn from **0** to **I**. Why?

Models with keyless access system

The power mode does not change from **VEHICLE OFF (LOCK)** to **ACCESSORY**. Why?



- The steering wheel may be locked.

Models without keyless access system

- Try to turn the steering wheel left and right while turning the ignition key.

Models with keyless access system

- Move the steering wheel left and right after pressing the **ENGINE START/STOP** button.



Continuously variable transmission models without keyless access system

The ignition switch does not turn from **I** to **0** and I cannot remove the key. Why?

Continuously variable transmission models with keyless access system

The power mode does not change from **ACCESSORY** to **VEHICLE OFF (LOCK)**. Why?



Continuously variable transmission models

The shift lever should be moved to **P**.



Q Why does the brake pedal pulsate slightly when applying the brakes?

A This can occur when the ABS activates and does not indicate a problem. Apply firm, steady pressure on the brake pedal. Never pump the brake pedal.

➤ Anti-lock Brake System (ABS) ➔ P. 637

Q The rear door cannot be opened from inside the vehicle. Why?

A Check if the childproof lock is in the lock position. If so, open the rear door with the outside door handle.

To cancel this function, slide the lever up to the unlock position.

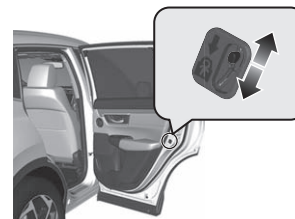

Q Why do the doors lock after I unlocked the doors?

A If you do not open the doors within 30 seconds, the doors are relocked automatically for security.

Q Why does the beeper sound when I open the driver's door?

A The beeper sounds when:

- The exterior lights are left on.
- The Auto Idle Stop* is in operation.

Models with keyless access system

- The power mode is in ACCESSORY.

Q Why does the beeper sound when I start driving?

A The beeper sounds when the driver and/or any passengers are not wearing their seat belts.

Q Pressing the electric parking brake switch does not release the parking brake. Why?

A Press the electric parking brake switch with the brake pedal depressed.

Q Depressing the accelerator pedal does not release the parking brake automatically. Why?

A

- Fasten the driver's seat belt.
- Check if the transmission is in **P*** or **N**. If so, select any other position.

Q Why do I hear a screeching sound when I apply the brake pedal?

A The brake pads may need to be replaced. Have your vehicle inspected by a dealer.

Q I'm seeing an amber indicator of a tyre with an exclamation point. What is that?

A The Deflation Warning System needs attention. If you recently inflated or changed a tyre, you have to reinitialise the system.
➤ Deflation Warning System ➔ P. 551



Is it possible to use unleaded petrol with a Research Octane Number (RON) of 91 or higher on this vehicle?



Your vehicle is designed to operate on premium unleaded petrol with a research octane of 95 or higher. If this octane grade is unavailable, regular unleaded petrol with a research octane of 91 or higher may be used temporarily. The use of regular unleaded petrol can cause metallic knocking noises in the engine and will result in decreased engine performance. The long-term use of regular-grade petrol can lead to engine damage.

Safe Driving

You can find many safety recommendations throughout this chapter, and throughout this manual.

For Safe Driving

Important Safety Precautions.....	38
Important Handling Information.....	40
Your Vehicle's Safety Features.....	41
Safety Checklist	42

Seat Belts

About Your Seat Belts	43
Fastening a Seat Belt	49
Seat Belt Inspection.....	53
Anchorage Points.....	54

Airbags

Airbag System Components.....	56
-------------------------------	----

Types of Airbags	58
Front Airbags (SRS)	58
Side Airbags.....	63
Side Curtain Airbags	65
Airbag System Indicators.....	67
Airbag Care	69

Child Safety

Protecting Child Passengers	70
Safety of Infants and Small Children...	73
Safety of Larger Children	91

Exhaust Gas Hazard

Carbon Monoxide Gas.....	94
--------------------------	----

Safety Labels

Label Locations	95
-----------------------	----

The following pages explain your vehicle's safety features and how to use them properly. The safety precautions below are ones that we consider to be among the most important.

Important Safety Precautions

■ Always wear your seat belt

A seat belt is your best protection in all types of collisions. Airbags are designed to supplement seat belts, not replace them. So even though your vehicle is equipped with airbags, make sure you and your passengers always wear your seat belts, and wear them properly.

■ Restrain all children

Children aged 12 and under should ride properly restrained in a back seat, not the front seat. Infants and small children should be restrained in a child restraint system. Larger children should use a booster seat and a lap/shoulder seat belt until they can use the belt properly without a booster seat.

■ Be aware of airbag hazards

While airbags can save lives, they can cause serious or fatal injuries to occupants who sit too close to them, or are not properly restrained. Infants, young children, and short adults are at the greatest risk. Be sure to follow all instructions and warnings in this manual.

■ Don't drink and drive

Alcohol and driving don't mix. Even one drink can reduce your ability to respond to changing conditions, and your reaction time gets worse with every additional drink. So don't drink and drive, and don't let your friends drink and drive, either.

⌘ For Safe Driving

Some countries prohibit the use of mobile phones other than hands-free devices by the driver while driving.

■ Pay appropriate attention to the task of driving safely

Engaging in mobile phone conversation or other activities that keep you from paying close attention to the road, other vehicles, and pedestrians could lead to a crash. Remember, situations can change quickly, and only you can decide when it is safe to divert some attention away from driving.

■ Control your speed

Excessive speed is a major factor in crash injuries and deaths. Generally, the higher the speed, the greater the risk, but serious injuries can also occur at lower speeds. Never drive faster than is safe for current conditions, regardless of the maximum speed posted.

■ Keep your vehicle in safe condition

Having a tyre blowout or a mechanical failure can be extremely hazardous. To reduce the possibility of such problems, check your tyre pressures and condition frequently, and perform all regularly scheduled maintenance.

■ Do not leave children unattended in the vehicle

Children left unattended in the vehicle may be injured if they activate one or more of the vehicle controls. They may also cause the vehicle to move, resulting in a crash in which the children and/or another person(s) can be injured or killed. Also, depending on the ambient temperature, the temperature of the interior may reach extreme levels, which can result in injury or death.

Even if the climate control system is on, never leave children in the vehicle unattended as the climate control system can shut off at any time.

Important Handling Information

Your vehicle has higher ground clearance than a passenger vehicle designed for use only on pavement. Higher ground clearance has many advantages for off-road driving. It allows you to travel over bumps, obstacles, and rough terrain. It also provides good visibility so you can anticipate problems earlier.

These advantages come at some cost. Because your vehicle is taller and rides higher off the ground, it has a higher centre gravity making it more susceptible to tipping or roll over if you make abrupt turns. Utility vehicles have a significantly higher rollover rate than other types of vehicles. In a rollover crash, an unbelted person is significantly more likely to die than a person wearing a seat belt. As a reminder, make sure you and your passengers always wear seat belts.

► Important Handling Information

For information on how to reduce the risk of rollover, read:

► **Precautions While Driving** P. 520

► **Off-road Guidelines** P. 512

Failure to operate your vehicle correctly might result in a crash or a rollover.

In many countries, the law prohibits off-road driving, e. g. driving in forests, trailblazing, etc. Please check your local laws and regulations before commencing any off-road driving activity.

Your Vehicle's Safety Features

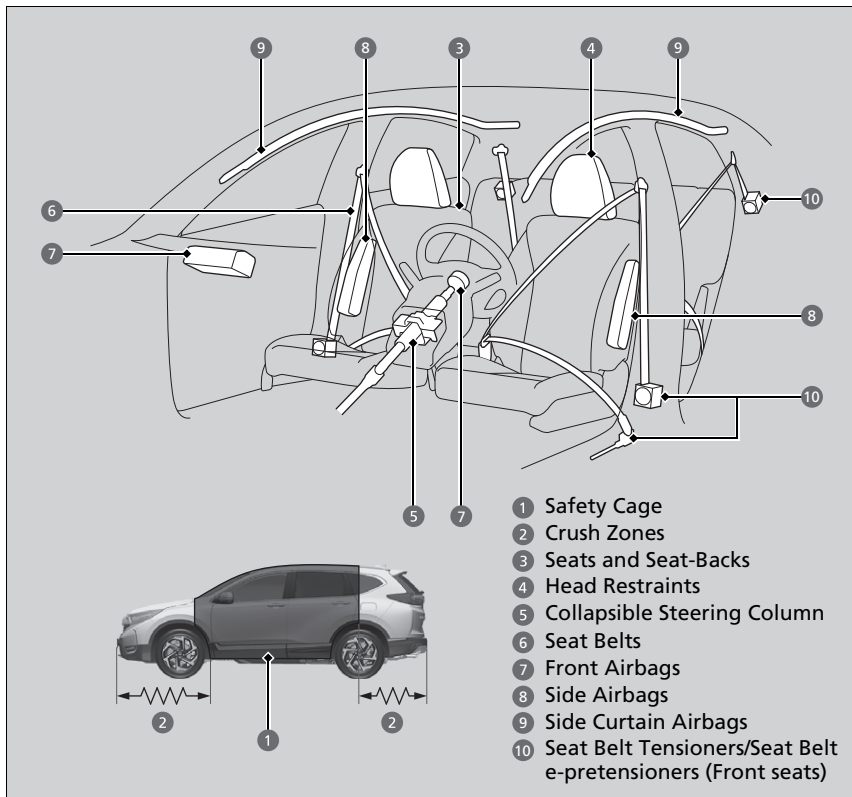

The following checklist will help you take an active role in protecting yourself and your passengers.

▣ Your Vehicle's Safety Features

Your vehicle is equipped with many features that work together to help to protect you and your passengers during a crash.

Some features do not require any action on your part. These include a strong steel framework that forms a safety cage around the passenger compartment, front and rear crush zones, a collapsible steering column, and tensioners that tighten the front seat belts in a sufficient crash.

However, you and your passengers cannot take full advantage of these features unless you remain seated in the correct position and always wear your seat belts. In fact, some safety features can contribute to injuries if they are not used properly.

Safety Checklist

For the safety of you and your passengers, make a habit of checking these items each time before you drive.

- Adjust your seat to a position suitable for driving. Be sure the front seats are adjusted as far to the rear as possible while allowing the driver to control the vehicle. Sitting too close to a front airbag can result in serious or fatal injury in a crash.
 - **Adjusting the Seats** P. 249
- Adjust head restraints to the proper position. Head restraints are most effective when the centre of the head restraint aligns with the centre of your head. Taller persons should adjust their head restraint to the highest position.
 - **Adjusting the Front Head Restraints** P. 262
- Always wear your seat belt, and make sure you wear it properly. Confirm that any passengers are properly belted as well.
 - **Fastening a Seat Belt** P. 49
- Protect children by using seat belts or child restraint systems according to a child's age, height and weight.
 - **Child Safety** P. 70

► Safety Checklist

If the door and/or tailgate open message appears on the driver information interface, a door and/or the tailgate is not completely closed. Close all doors and the tailgate tightly until the message disappears.

➤ **Driver Information Interface Warning and Information Messages** P. 122

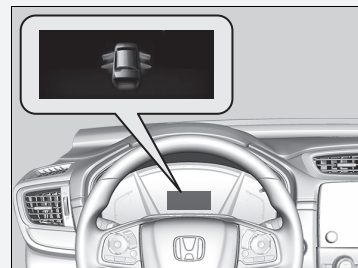

About Your Seat Belts

Seat belts are the single most effective safety device because they keep you connected to the vehicle so that you can take advantage of many built-in safety features. They also help to keep you from being thrown against the inside of the vehicle, against any passengers, or out of the vehicle. When worn properly, seat belts also keep your body properly positioned in a crash so that you can take full advantage of the additional protection provided by the airbags.

In addition, seat belts help to protect you in almost every type of crash, including:

- frontal impacts
- side impacts
- rear impacts
- rollovers

⌘ About Your Seat Belts

⚠ WARNING

Not wearing a seat belt properly increases the chance of serious injury or death in a crash, even though your vehicle has airbags.

Be sure you and your passengers always wear seat belts and wear them properly.

WARNING: Seat belts are designed to bear upon the bony structure of the body, and should be worn low across the front of the pelvis or the pelvis, chest and shoulders, as applicable; wearing the lap section of the belt across the abdominal area must be avoided.

WARNING: Seat belts should be adjusted as firmly as possible, consistent with comfort, to provide the protection for which they have been designed. A slack belt will greatly reduce the protection afforded to the wearer.

WARNING: Belts should not be worn with straps twisted.

WARNING: Each belt assembly must only be used by one occupant; it is dangerous to put a belt around a child being carried on the occupant's lap.

■ Lap/shoulder seat belts

All five or seven seating positions are equipped with lap/shoulder seat belts with emergency locking retractors. In normal driving the retractor lets you move freely while keeping some tension on the belt. During a collision or sudden stop the retractor locks to restrain your body.

The seat belt must be properly secured when using a front-facing child restraint system.

➤ **Installing a Child Restraint System with a Lap/Shoulder Seat Belt** P. 88

■ Proper use of seat belts

Follow these guidelines for proper use:

- All occupants should sit upright, well back in the seat, and remain in that position for the duration of the trip. Slouching and leaning reduce the effectiveness of the belt and can increase the chance of serious injury in a crash.
- Never place the shoulder part of a lap/shoulder seat belt under your arm or behind your back. This could cause very serious injuries in a crash.
- Two people should never use the same seat belt. If they do, they could be very seriously injured in a crash.
- Do not put any accessories on the seat belts. Devices intended to improve comfort or reposition the shoulder part of a seat belt can reduce the protective capability and increase the chance of serious injury in a crash.

➤ About Your Seat Belts

Seat belts cannot completely protect you in every crash. But in most cases, seat belts can reduce your risk of serious injury.

Most countries require you to wear seat belts. Take time to familiarise with the legal requirements of the countries in which you will drive.

If you extend the seat belt too quickly, it will lock in place. If this happens, slightly retract the seat belt, then extend it slowly.

Seat Belt Reminder

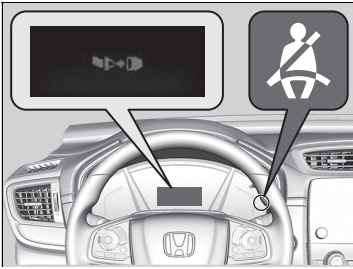

■ Front seats

The seat belt system includes an indicator on the instrument panel to remind the driver or a front passenger or both to fasten their seat belts.

If the ignition switch is turned to ON **II***¹ and a seat belt is not fastened, the indicator will blink. After a few seconds, the indicator will come on and remain illuminated until the seat belt is fastened.

The beeper will periodically sound and the indicator will blink while the vehicle is moving until the seat belt is fastened.

⊞ Seat Belt Reminder

The indicator will also come on if a front passenger does not fasten their seat belt within six seconds after the ignition switch is turned to ON **II***¹.

When no one is sitting in the front passenger's seat, the indicator will not come on and the beeper will not sound.

If the indicator comes on or the beeper sounds with no one sitting in the front passenger's seat. Check if:

- There is nothing heavy placed on the front passenger seat.
- The driver's seat belt is fastened.

If the indicator does not light when the passenger is seated and is not fastened, something may be interfering with the occupant detection sensor.

Check if:

- A cushion is placed on the seat.
- The front passenger is not sitting properly.

If none of these conditions exist, have your vehicle checked by a dealer.

*1: Models with the keyless access system have an **ENGINE START/STOP** button instead of an ignition switch.

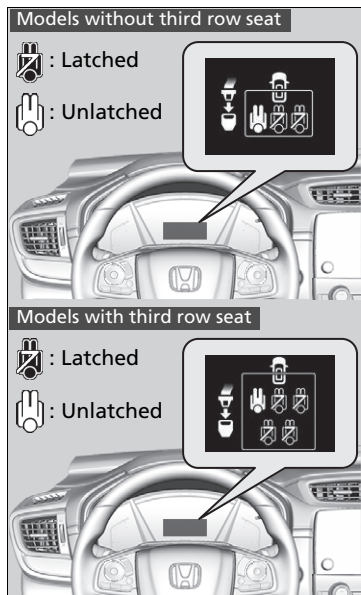

■ Rear seats

Your vehicle monitors rear seat belt use. The driver information interface notifies you if any of the rear seat belts are used.

The display appears when:

- A rear door is opened or closed.
- Any of the rear passengers latches or unlatches their seat belt.

The beeper sounds if any rear passenger's seat belt is unlatched while driving.

To see the display:

Press the  (display/information) button.

Automatic Seat Belt Tensioners

The front and the outer second row seats are equipped with automatic seat belt tensioners to enhance safety.

The tensioners automatically tighten the front seat belts and the outer second row seat belts during a moderate-to-severe frontal collision, sometimes even if the collision is not severe enough to inflate the front airbags.

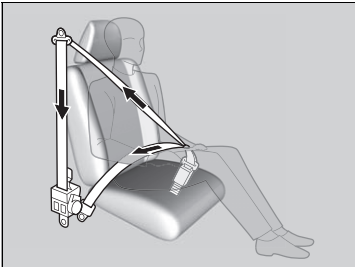

Automatic Seat Belt Tensioners

The seat belt tensioners can only operate once. If a tensioner is activated, the SRS indicator will come on. Have a dealer replace the tensioner and thoroughly inspect the seat belt system as it may not offer protection in a subsequent crash.

During a moderate-to-severe side impact, the tensioner on that side of the vehicle also activates.

■ Seat Belt e-pretensioners

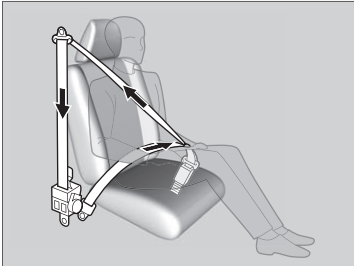

Are the motor-powered pretensioners that start to retract the front seat belts when the CMBS, brake assist system, or VSA system is in operation. They may also activate when you steer the vehicle hard, or the vehicle is impacted. After retracted, the seat belts are slackened to their original positions. As convenient features, the e-pretensioners slightly retract the seat belts when you latch the seat belt buckle, depress the brake pedal more aggressively than you normally do, or make a sharp turn, and fully retract when you release the seat belt buckle.

▣ Seat Belt e-pretensioners

If only the e-pretensioners were activated, no components need to be replaced.

The e-pretensioners may not work if:

- Supplemental Restraint System Indicator is on.
- Vehicle Stability Assist (VSA) System Indicator is on.

Fastening a Seat Belt

After adjusting a front seat to the proper position, and while sitting upright and well back in the seat:

➤ **Adjusting the Seats** P. 249

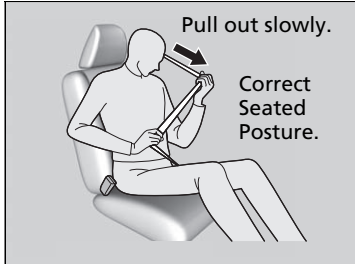

1. Pull the seat belt out slowly.

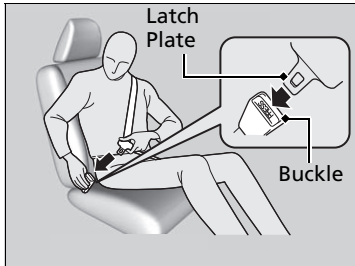

2. Insert the latch plate into the buckle, then tug on the belt to make sure the buckle is secure.

▶ Make sure that the belt is not twisted or caught on anything.

When you or the front passenger insert the latch plate into the buckle, the front seat belt retracts automatically.

➤ **Seat Belt e-pretensioners** P. 48

Fastening a Seat Belt

No one should sit in a seat with an inoperative seat belt or one that does not appear to be working correctly. Using a seat belt that is not working properly may not protect the occupant in a crash. Have a dealer check the belt as soon as possible.

Never insert any foreign objects into the buckle or retractor mechanism.

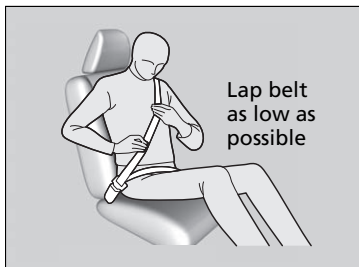

3. Position the lap part of the belt as low as possible across your hips, then pull up on the shoulder part of the belt so the lap part fits snugly. This lets your strong pelvic bones take the force of a crash and reduces the chance of internal injuries.
4. If necessary, pull up on the belt again to remove any slack, then check that the belt rests across the centre of your chest and over your shoulder. This spreads the forces of a crash over the strongest bones in your upper body.

■ Adjusting the Shoulder Anchor

The front seats have adjustable shoulder anchors to accommodate taller and shorter occupants.

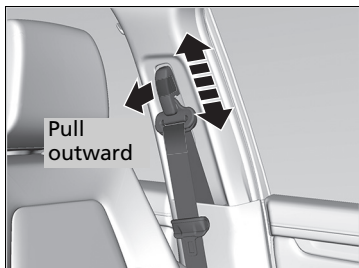

1. Move the anchor up and down while pulling the release outward.
2. Position the anchor so that the belt rests across the centre of your chest and over your shoulder.

⊗ Fastening a Seat Belt

⚠ WARNING

Improperly positioning the seat belts can cause serious injury or death in a crash.

Make sure all seat belts are properly positioned before driving.

To release the belt, push the red **PRESS** button and then guide the belt by hand until it has retracted completely.

When exiting the vehicle, be sure the belt is properly stowed so that it will not get caught in the closing door.

⊗ Adjusting the Shoulder Anchor

The shoulder anchor height can be adjusted to four levels. If the belt contacts your neck, lower the height one level at a time.

After an adjustment, make sure that the shoulder anchor position is secure.

Seat Belt with Detachable Anchor*

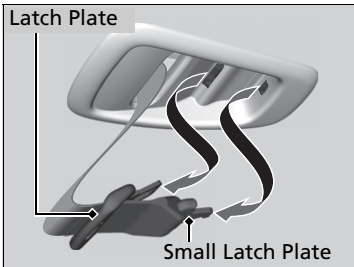

1. Pull out the seat belt's small latch plate and the latch plate from each holding slot in the ceiling.

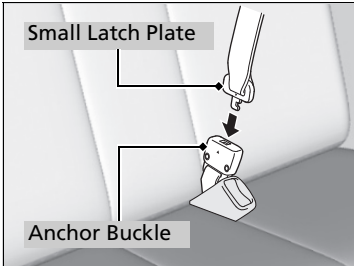

2. Line up the triangle marks on the small latch plate and anchor buckle. Make sure the seat belt is not twisted. Attach the belt to the anchor buckle.

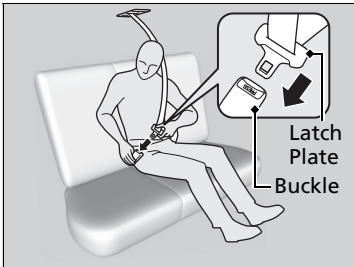

3. Insert the latch plate into the buckle. Properly fasten the seat belt the same way you fasten the lap/shoulder seat belt.

Seat Belt with Detachable Anchor*

⚠ WARNING

Using the seat belt with the detachable anchor unlatched increases the chance of serious injury or death in a crash.

Before using the seat belt, make sure the detachable anchor is correctly latched.

To unlatch the detachable anchor, insert the latch plate into the slot on the side of the anchor buckle.

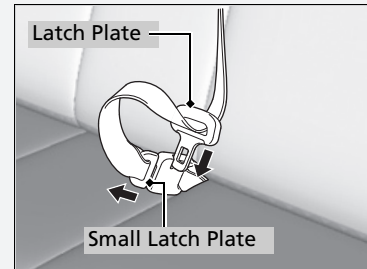

* Not available on all models

Continued

■ Advice for Pregnant Women

If you are pregnant, the best way to protect yourself and your unborn child when driving or riding in a vehicle is to always wear a seat belt and keep the lap part of the belt as low as possible across the hips.

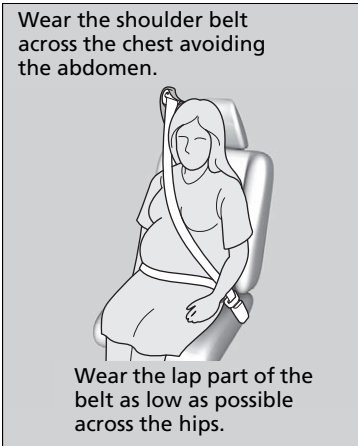

▣ Advice for Pregnant Women

Each time you have a checkup, ask your doctor if it is okay for you to drive.

To reduce the risk of injuries to both you and your unborn child that can be caused by an inflating front airbag:

- When driving, sit upright and adjust the seat as far back as possible while allowing full control of the vehicle.
- When sitting in the front passenger's seat, adjust the seat as far back as possible.

Seat Belt Inspection

Regularly check the condition of your seat belts as follows:

- Pull each belt out fully, and look for frays, cuts, burns, and wear.
- Check that the latch plates and buckles work smoothly and the belts retract easily.
 - ▶ If a belt does not retract easily, cleaning the belt may correct the problem. Only use a mild soap and warm water. Do not use bleach or cleaning solvents. Make sure the belt is completely dry before allowing it to retract.

Any belt that is not in good condition or working properly will not provide proper protection and should be replaced as soon as possible.

A belt that has been worn during a crash may not provide the same level of protection in a subsequent crash. Have your seat belts inspected by a dealer after any collision.

Seat Belt Inspection

⚠ WARNING

Not checking or maintaining seat belts can result in serious injury or death if the seat belts do not work properly when needed.

Check your seat belts regularly and have any problem corrected as soon as possible.

WARNING: No modifications or additions should be made by the user which will either prevent the seat belt adjusting devices from operating to remove slack, or prevent the seat belt assembly from being adjusted to remove slack.

WARNING: It is essential to replace the entire assembly after it has been worn in a severe impact even if damage to the assembly is not obvious.

WARNING: Care should be taken to avoid contamination of the webbing with polishes, oils and chemicals, and particularly battery acid. Cleaning may safely be carried out using mild soap and water. The belt should be replaced if webbing becomes frayed, contaminated or damaged.

Anchorage Points



When replacing the seat belts, use the anchorage points shown in the images. The front seat has a lap/shoulder belt.

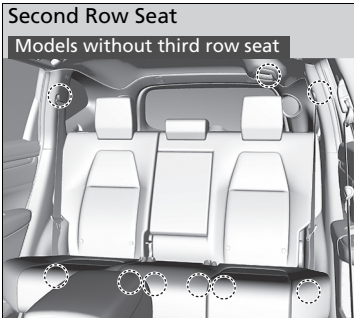

The second row seats has three lap/shoulder belts.

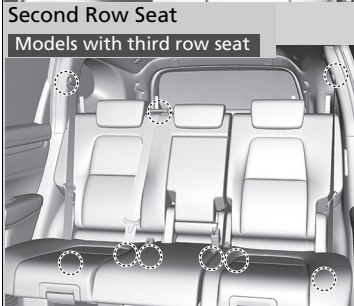

Third Row Seat*

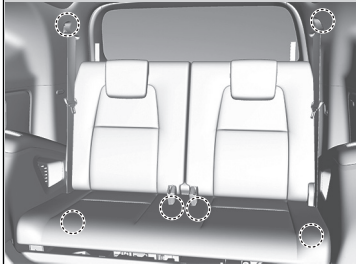

The third row seats* have two lap/shoulder belts.

* Not available on all models

Airbag System Components

The front, front side, and side curtain airbags are deployed according to the direction and severity of impact. The airbag system includes:

- Two SRS (Supplemental Restraint System) front airbags. The driver's airbag is stored in the centre of the steering wheel; the front passenger's airbag is stored in the dashboard. Both are marked **SRS AIRBAG**.
- Two side airbags, one for the driver and one for a front passenger. The airbags are stored in the outer edges of the seat-backs. Both are marked **SIDE AIRBAG**.
- Two side curtain airbags, one for each side of the vehicle. The airbags are stored in the ceiling, above the side windows. The front and rear pillars are marked **SIDE CURTAIN AIRBAG**.

- An electronic control unit that, when the ignition switch is in ON **II***¹, continually monitors information about the various impact sensors, airbag activators, seat belt tensioners, passenger front airbag **ON/OFF** switch, passenger front airbag off indicator and other vehicle information. During a crash event the unit can record such information.
- Automatic seat belt tensioners for the front seats and outer second row seats.
- The front seat belt tensioners also include the e-pretensioners.
- Impact sensors that can detect a moderate-to-severe front or side impact.
- An indicator on the instrument panel that alerts you to a possible problem with your airbag system or seat belt tensioners.
- An indicator on the dashboard that alerts you that the front passenger's front airbag has been turned off.
- Safing sensor*

*1: Models with the keyless access system have an **ENGINE START/STOP** button instead of an ignition switch.

* Not available on all models

Important Facts About Your Airbags

Airbags can pose serious hazards. To do their job, airbags must inflate with tremendous force. So, while airbags help to save lives, they can cause burns, bruises, and other minor injuries, sometimes even fatal ones if occupants are not wearing their seat belts properly and sitting correctly.

What you should do: Always wear your seat belt properly, and sit upright and as far back from the steering wheel as possible while allowing full control of the vehicle. A front passenger should move their seat as far back from the dashboard as possible.

Remember, however, that no safety system can prevent all injuries or deaths that can occur in a severe crash, even when seat belts are properly worn and the airbags deploy.

Do not place hard or sharp objects between yourself and a front airbag.

Carrying hard or sharp objects on your lap, or driving with a pipe or other sharp object in your mouth, can result in injuries if your front airbag inflates.

Do not attach or place objects on the front airbag covers. Objects on the covers marked **SRS AIRBAG** could interfere with the proper operation of the airbags or be propelled inside the vehicle and hurt someone if the airbags inflate.

Important Facts About Your Airbags

Do not attempt to deactivate your airbags. Together, airbags and seat belts provide the best protection.

When driving, keep hands and arms out of the deployment path of the front airbag by holding each side of the steering wheel. Do not cross an arm over the airbag cover.

Types of Airbags

Your vehicle is equipped with three types of airbags:

- **Front airbags:** Airbags in front of the driver's and front passenger's seats.
- **Side airbags:** Airbags in the driver's and front passenger's seat-backs.
- **Side curtain airbags:** Airbags above the side windows.

Each is discussed in the following pages.

Front Airbags (SRS)

The front SRS airbags inflate in a moderate-to-severe frontal collision to help to protect the head and chest of the driver and/or front passenger.

SRS (Supplemental Restraint System) indicates that the airbags are designed to supplement seat belts, not replace them. Seat belts are the occupant's primary restraint system.

Housing Locations

The front airbags are housed in the centre of the steering wheel for the driver, and in the dashboard for the front passenger. Both airbags are marked **SRS AIRBAG**.

*1: Models with the keyless access system have an **ENGINE START/STOP** button instead of an ignition switch.

Types of Airbags

The airbags can inflate whenever the ignition switch is in ON *1.

After an airbag inflates in a crash, you may see a small amount of smoke. This is from the combustion process of the inflator material and is not harmful. People with respiratory problems may experience some temporary discomfort. If this occurs, get out of the vehicle as soon as it is safe to do so.

■ Operation

Front airbags are designed to inflate during moderate-to-severe frontal collisions. When the vehicle decelerates suddenly, the sensors send information to the control unit which signals one or both front airbags to inflate.

A frontal collision can be either head-on or angled between two vehicles, or when a vehicle crashes into a stationary object, such as a concrete wall.

■ How the Front Airbags Work

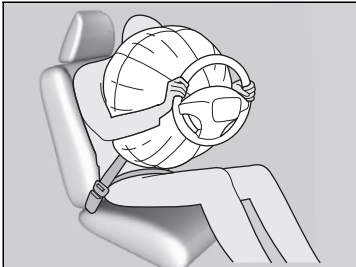

While your seat belt restrains your torso, the front airbag provides supplemental protection for your head and chest.

The front airbags deflate immediately so that they won't interfere with the driver's visibility or the ability to steer or operate other controls.

The total time for inflation and deflation is so fast that most occupants are not aware that the airbags deployed until they see them lying in front of them.

■ When front airbags should not deploy

Minor frontal crashes: Front airbags were designed to supplement seat belts and help to save lives, not to prevent minor scrapes, or even broken bones that might occur during a less than moderate-to-severe frontal crash.

Side impacts: Front airbags can provide protection when a sudden deceleration causes a driver or front passenger to move towards the front of the vehicle. Side airbags and side curtain airbags have been specifically designed to help to reduce the severity of injuries that can occur during a moderate-to-severe side impact which can cause the driver or passenger to move towards the side of the vehicle.

Rear impacts: Head restraints and seat belts are your best protection during a rear impact. Front airbags cannot provide any significant protection and are not designed to deploy in such collisions.

Rollovers: Seat belts and side curtain airbags offer the best protection in a rollover. Because front airbags could provide little if any protection, they are not designed to deploy during a rollover.

■ When front airbags deploy with little or no visible damage

Because the airbag system senses sudden deceleration, a strong impact to the vehicle framework or suspension might cause one or more of the airbags to deploy. Examples include running into a curb, the edge of a hole, or other low fixed object that causes a sudden deceleration in the vehicle chassis. Since the impact is underneath the vehicle, damage may not be readily apparent.

■ When front airbags may not deploy, even though exterior damage appears severe

Since crushable body parts absorb crash energy during an impact, the amount of visible damage does not always indicate proper airbag operation. In fact, some collisions can result in severe damage but no airbag deployment because the airbags would not have been needed or would not have provided protection even if they had deployed.

Passenger Front Airbag Off System

If it is unavoidable to install a rear-facing child restraint system in the front passenger seat, you must manually deactivate the passenger front airbag system, using the key.

Passenger front airbag ON/OFF switch



When the passenger front airbag **ON/OFF** switch is in:

OFF: The passenger front airbag is deactivated. The passenger front airbag does not inflate during a frontal crash that inflates driver's front airbag.

The passenger front airbag off indicator stays on as a reminder.

ON: The passenger front airbag is activated. The passenger front airbag on indicator comes on and remains on for about 60 seconds.

To deactivate the passenger front airbag system

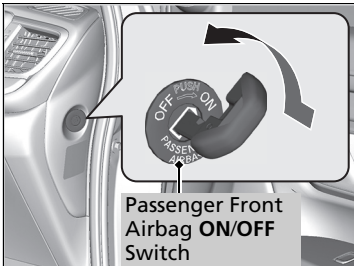

1. Set the parking brake, and turn the ignition switch to LOCK [0]*1. Remove the key.
2. Open the front passenger's door.
3. Insert the key to the passenger front airbag **ON/OFF** switch.

▶ The switch is located at the side panel of the front passenger side instrument panel.

4. Turn the key to **OFF**, and remove it from the switch.

*1: Models with the keyless access system have an **ENGINE START/STOP** button instead of an ignition switch.

Passenger Front Airbag Off System

WARNING

The passenger front airbag system must be turned off, if it is not avoidable to put a rear-facing child restraint system in the front passenger seat.

If the front passenger airbag inflates, it can hit the rear-facing child restraint system with enough force to kill or cause a very serious injury to the infant.

WARNING

Make sure to turn on the passenger front airbag system when a rear-facing child restraint system is not used on the front passenger seat.

Leaving the passenger front airbag system deactivated can result in serious injury or death in a crash.

■ Passenger front airbag off indicator

When the passenger front airbag system is activated, the indicator goes off after a few seconds when you turn the ignition switch to ON *1.

When the passenger front airbag system is deactivated, the indicator stays on, or goes off momentarily and comes back on.

■ Passenger front airbag off system label

The label is located at the side panel of the front passenger side instrument panel.

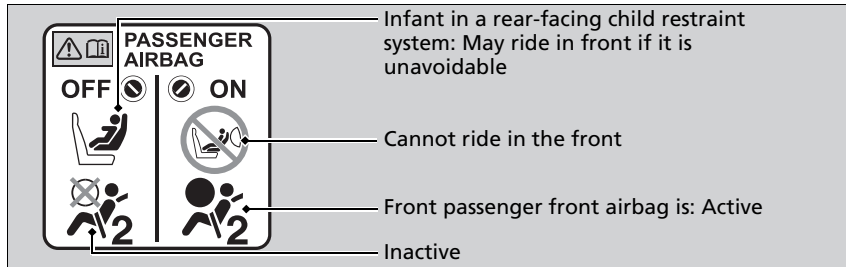

▶ Passenger Front Airbag Off System

NOTICE

- Use your vehicle's key to turn the passenger front airbag **ON/OFF** switch. If you use a different key, the switch can be damaged, or the passenger front airbag system may not work properly.
- Do not close the door or apply an excessive load on the key while the key is in the passenger front airbag **ON/OFF** switch. The switch or the key can be damaged.

We strongly recommend that you do not install a rear-facing child restraint system in the front passenger seat.

Protecting Infants P. 73

It is your responsibility to change the setting of the passenger front airbag system to **OFF** when you put a rear-facing child restraint system on the front passenger seat.

When a rear-facing child restraint system is not in use in the front passenger seat, turn the system back on.

*1: Models with the keyless access system have an **ENGINE START/STOP** button instead of an ignition switch.

Side Airbags

The side airbags help to protect the torso and pelvis of the driver or a front passenger during a moderate-to-severe side impact.

Housing Locations

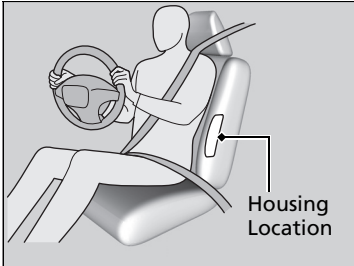

The side airbags are housed in the outside edge of the driver's and passenger's seat-backs.

Both are marked **SIDE AIRBAG**.

Side Airbags

Do not let the front passenger lean sideways with their head in the deployment path of the side airbag. An inflating side airbag can strike with strong force and seriously injure the passenger.

Do not attach accessories on or near the side airbags. They can interfere with the proper operation of the airbags, or hurt someone if an airbag inflates.

■ Operation

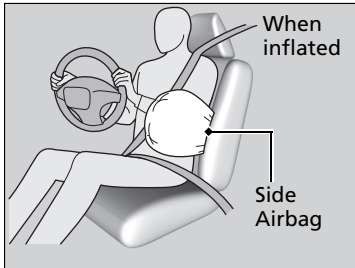

When the sensors detect a moderate-to-severe side impact, the control unit signals the side airbag on the impact side to immediately inflate.

■ When a side airbag deploys with little or no visible damage

Because the airbag system senses sudden acceleration, a strong impact to the side of the vehicle's framework can cause a side airbag to deploy. In such cases, there may be little or no damage, but the side impact sensors detected a severe enough impact to deploy the airbag.

■ When a side airbag may not deploy, even though visible damage appears severe

It is possible for a side airbag to not deploy during an impact that results in apparently severe damage. This can occur when the point of impact was towards the far front or rear of the vehicle, or when the vehicle's crushable body parts absorbed most of the crash energy. In either case, the side airbag would not have been needed nor provided protection even if it had deployed.

⌘ Side Airbags

Do not cover or replace the front seat-back covers without consulting a dealer. Improperly replacing or covering front seat-back covers can prevent your side airbags from properly deploying during a side impact.

Side Curtain Airbags

The side curtain airbags help to protect the heads of the driver and any passengers during a moderate-to-severe side impact.

Housing Locations

Models with third row seat

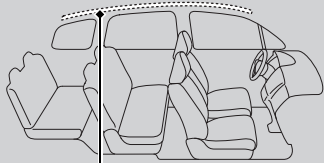

Side Curtain Airbag Storage

Models without third row seat

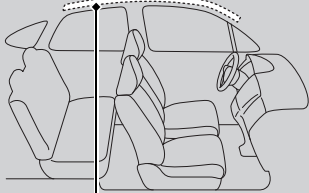

Side Curtain Airbag Storage

The side curtain airbags are located in the ceiling above the side windows on both sides of the vehicle.

Side Curtain Airbags

The side curtain airbags are most effective when an occupant is wearing their seat belt properly and sitting upright, well back in their seat.

Do not attach any objects to the side windows or roof pillars as they can interfere with the proper operation of the side curtain airbags.

Do not put a coat hanger or hard objects on a coat hook. This could result in injuries if your side curtain airbag inflates.

■ Operation

Models with third row seat

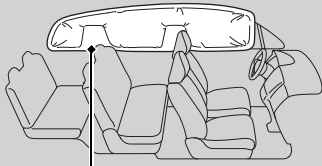

Deployed Side Curtain Airbag

Models without third row seat

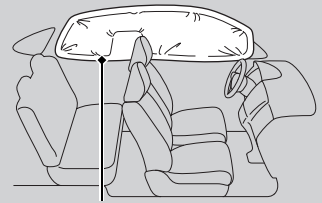

Deployed Side Curtain Airbag

The side curtain airbag is designed to deploy in a moderate-to-severe side impact.

■ When side curtain airbags deploy in a frontal collision

One or both side curtain airbags may also inflate in a moderate-to-severe angled frontal collision.

Airbag System Indicators

If a problem occurs in the airbag system, the SRS indicator will come on and a message appears on the driver information interface.

Supplemental Restraint System (SRS) Indicator

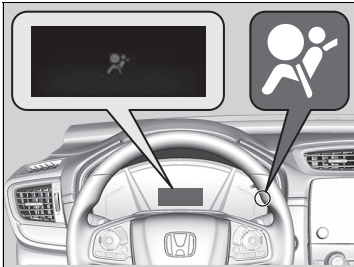

■ When the ignition switch is turned to ON *1

The indicator comes on for a few seconds, then goes off. This tells you the system is working properly.

If the indicator comes on at any other time, or does not come on at all, have the system checked by a dealer as soon as possible. If you don't, your airbags and seat belt tensioners may not work properly when they are needed.

*1: Models with the keyless access system have an **ENGINE START/STOP** button instead of an ignition switch.

Supplemental Restraint System (SRS) Indicator

WARNING

Ignoring the SRS indicator can result in serious injury or death if the airbag systems or tensioners do not work properly.

Have your vehicle checked by a dealer as soon as possible if the SRS indicator alerts you to a possible problem.

WARNING

Remove the rear-facing child restraint system immediately from the front passenger seat if the SRS indicator comes on. Even if the passenger front airbag has been deactivated, do not ignore the SRS indicator.

The SRS system may have a fault which could cause the passenger front airbag to be activated, causing serious injury or death.

■ Passenger Front Airbag Off Indicator

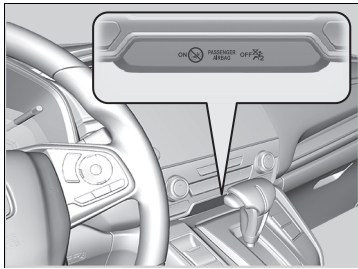

■ When the passenger front airbag off indicator comes on

The indicator stays on while the passenger's front airbag system is deactivated.

When a rear-facing child restraint system is not in use in the front passenger seat, manually turn the system back on. The indicator should go off.

Airbag Care

You do not need to, and should not, perform any maintenance on or replace any airbag system components yourself. However, you should have your vehicle inspected by a dealer in the following situations:

■ When the airbags have deployed

If an airbag has inflated, the control unit and other related parts must be replaced. Similarly, once an automatic seat belt tensioner has been activated, it must be replaced.

■ When the vehicle has been in a moderate-to-severe collision

Even if the airbags did not inflate, have your dealer inspect the following: front seat belt tensioners, and each seat belt that was worn during the crash.

⚠ Airbag Care

The removal of airbag components from the vehicle is prohibited.

In case of malfunction, or shutdown, or after the airbag inflation/seat belt tensioner operation, ask a qualified personnel for handling.

We recommend against the use of salvaged airbag system components, including the airbag, tensioners, sensors, and control unit.

Protecting Child Passengers

Each year, many children are injured or killed in vehicle crashes because they are either unrestrained or not properly restrained. In fact, vehicle crashes are the number one cause of death of children aged 12 and under.

To reduce the number of child deaths and injuries, infants and children should be properly restrained when they ride in a vehicle.

Protecting Child Passengers

WARNING

Children who are unrestrained or improperly restrained can be seriously injured or killed in a crash.

Any child too small for a seat belt should be properly restrained in an approved child restraint system. A larger child should be properly restrained with a seat belt, using a booster seat if necessary.

In many countries, the law requires all children aged 12 and under, and whose height are shorter than 150 cm be properly restrained in a rear seat.

In many countries, it is required to use an officially approved and suitable child restraint system for transporting a child on any passenger seat. Check your local legal requirement.

European models

Child restraint systems must meet UN Regulation No. 44 or No. 129, or the regulations of the subject countries.

 **Selecting a Child Restraint System** P. 76

Except European models

We recommend that child restraint systems meet UN Regulation No. 44 or No. 129 or the regulations of the subject countries.

 **Selecting a Child Restraint System** P. 76

Children should sit properly restrained in a rear seat. This is because:

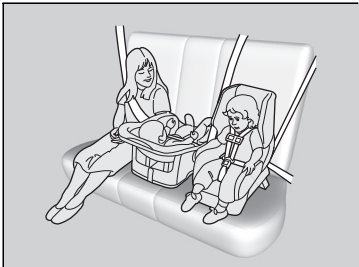

- An inflating front or side airbag can injure or kill a child sitting in the front seat.
- A child in the front seat is more likely to interfere with the driver's ability to safely control the vehicle.
- Statistics show that children of all sizes and ages are safer when they are properly restrained in a rear seat.

▶▶ Protecting Child Passengers

Front Passenger's Sun Visor

⚠ WARNING

⚠ AIRBAG

NEVER use a rearward facing child restraint on a seat protected by an ACTIVE AIRBAG in front of it, DEATH or SERIOUS INJURY to the CHILD can occur.

- Any child who is too small to wear a seat belt must be properly restrained in an approved child restraint system that is properly secured to the vehicle using the seat belt or the child restraint anchorage system.
- Never hold a child on your lap because it is impossible to protect them in the event of a collision.
- Never put a seat belt over yourself and a child. During a crash, the belt would likely press deep into the child and cause serious or fatal injuries.
- Never let two children use the same seat belt. Both children could be very seriously injured in a crash.
- Do not allow children to operate the doors, windows or seat adjustments.
- Do not leave children in the vehicle unattended, especially in hot weather when the inside of the vehicle can get hot enough to kill them. They could also activate vehicle controls causing it to move unexpectedly.

► Protecting Child Passengers

WARNING: Use the power window lock button to prevent children from opening the windows. Using this feature will prevent children from playing with the windows, which could expose them to hazards or distract the driver.

► Opening/Closing the Power Windows
P. 210

WARNING: Always take the ignition key with you whenever you leave the vehicle alone or with other occupants.

To remind you of the passenger's front airbag hazard and child safety, your vehicle has the warning label on the passenger's side sun visor. Please read and follow the instructions on this label.

► Safety Labels P. 95

Safety of Infants and Small Children

■ Protecting Infants

An infant must be properly restrained in a rear-facing, reclining child restraint system until the infant reaches the restraint system manufacturer's weight or height limit for the seat, and the infant is at least one year old.

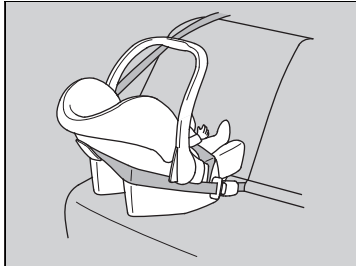

■ Positioning a rear-facing child restraint system

Child restraint system must be placed and secured in a rear seating position.

- ▶ If this occurs, we recommend that you install the child restraint system directly behind the front passenger's seat, move the seat as far forward as needed, and leave it unoccupied.
- Or, you may wish to get a smaller rear-facing child restraint system.
- ▶ Make sure that there is no contact between the child restraint system and the seat in front of it.

▶▶ Protecting Infants

⚠ WARNING

Placing a rear-facing child restraint system in the front seat can result in serious injury or death if the passenger's front airbag inflates.

Always place a rear-facing child restraint system in the back seat, not the front.

As required by UN Regulation No. 94:

⚠ WARNING



NEVER use a rearward facing child restraint on a seat protected by an ACTIVE AIRBAG in front of it, DEATH or SERIOUS INJURY to the CHILD can occur.

When properly installed, a rear-facing child restraint system may prevent the driver or a front passenger from moving their seat all the way back, or from locking their seat-back in the desired position.

▶▶ Protecting Infants

Many experts recommend use of a rear-facing child restraint system for a child up to two years old if the child's height and weight are appropriate for a rear-facing child restraint system.

If the passenger's front airbag inflates, it can hit the rear-facing child restraint system with great force, which can dislodge or strike the system, and seriously injure the child.

Rear-facing child restraint systems should never be installed in a front facing position.

Always refer to the child restraint system manufacturer's instructions before installation.

If it is absolutely unavoidable to install a rear-facing child restraint system in the front passenger seat, manually turn off the passenger front airbag system.

▶ **Passenger Front Airbag Off System** P. 61

■ Protecting Smaller Children

If a child is at least one year old and has exceeded the weight and height limitations of a rear-facing child restraint system, the child should be properly restrained in a firmly secured front-facing child restraint system until they exceed the weight and height limitations for the front-facing child restraint system.

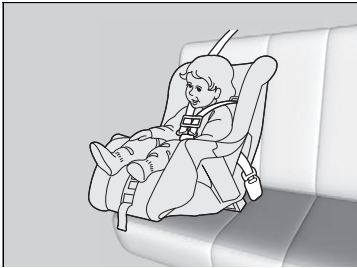

■ Front-facing child restraint system placement

We strongly recommend placing a front-facing child restraint system in a rear seating position.

Placing a front-facing child restraint system in the front seat can be hazardous. A rear seat is the safest place for a child.

▣ Protecting Smaller Children

⚠ WARNING

Placing a front-facing child restraint system in the front seat can result in serious injury or death if the front airbag inflates.

If you must place a front-facing child restraint system in front, move the vehicle seat as far back as possible, and properly restrain the child.

Educate yourself about the laws and regulations regarding child restraint system use where you are driving, and follow the child restraint system manufacturer's instructions.

■ Selecting a Child Restraint System

Some child restraint systems are lower anchorage compatible. Some have a rigid-type connector while others have a flexible-type connector. Both are equally easy to use. Some existing and previously owned child restraint systems can only be installed using the seat belt. Whichever type you choose, follow the child restraint system manufacturer's use and care instructions including recommended expiration dates as well as the instructions in this manual. Proper installation is key to maximizing your child's safety.

The flexible type may not be available in your country.

In seating positions and vehicles not equipped with lower anchorages, install a child restraint system using the seat belt and a top tether for added security. This is because all child restraint systems must be secured with the seat belt when the lower anchorage system is not in use. In addition, the child restraint system manufacturer may advise that a seat belt be used to attach an ISO FIX restraint system once a child reaches a specified weight. Please read the child restraint system owner's manual for proper installation instructions.

■ Important consideration when selecting a child restraint system

Make sure the child restraint system meets the following three requirements:

- The child restraint system is the correct type and size for the child.
- The child restraint system is the correct type for the seating position.
- The child restraint system is compliant with safety standards. We recommend a child restraint system compliant with UN Regulation No. 44 or No. 129, or the regulations of the subject countries. Look for the approval mark on the system and the manufacturer's statement of compliance on the box.

▶▶ Selecting a Child Restraint System

Installation of a lower anchorage-compatible child restraint system is simple.

Lower anchorage-compatible child restraint systems have been developed to simplify the installation process and reduce the likelihood of injuries caused by incorrect installation.

■ Child Restraint Systems Standards

If a child restraint system (whether an i-Size/ISOFIX type or one that is fitted with a seat belt) meets the relevant UN Regulation, it will be affixed with an approval label as shown in the adjacent table. Before purchasing or using any child restraint system, make sure to check the approval label and ensure that it is compatible with your vehicle and the child, and that it complies with the relevant UN Regulation.

▶▶ Selecting a Child Restraint System

Example of UN Regulation No. 44 approval label

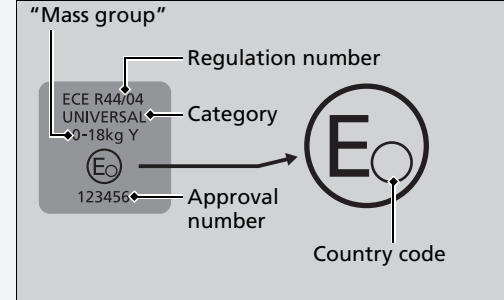



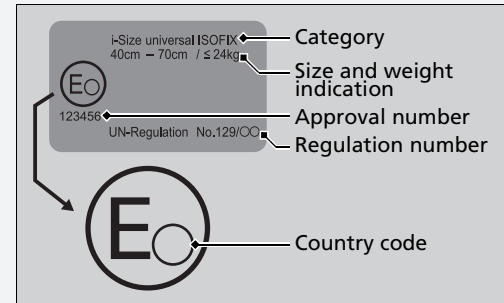



Example of UN Regulation No. 129 approval label



Locations for Child Restraint System Installation

5-seater



	Suitable for universal restraint systems installed with vehicle safety belts.
	Suitable for forward facing universal restraint systems installed with vehicle safety belts.
	Suitable for i-Size and ISOFIX child restraints systems.
	Suitable for forward facing restraint systems only.
	Never use a rearward facing child restraint system.
	Seat position equipped with Top Tether anchorages.

*1: When installing a child seat, adjust the seat slide to the most rear position and adjust the seat back angle to the most upright position.

*2: If you can not fix the child restraint system stably, adjust the seat back angle to be parallel with the back side of the child restraint system, still keeping it forward of the seat belt shoulder anchor.

*3: If you attach a child seat, you can not attach the seat belt of the left side seat.

Seat position number	Seating position				
	①		②	③	④
	Front passenger		2nd row		
	Passenger Airbag ON/OFF switch		Left	Centre	Right
ON	OFF				
Seating position suitable for universal belted (yes/no)	yes* ¹ Forward facing only	yes* ¹	yes	yes	yes
i-Size seating position (yes/no)	no	no	yes	no	yes
Seating position suitable for recommended child seat (yes/no)	yes	yes	yes	yes	yes
Seating position suitable for lateral fixture (L1/L2)	no	no	no	no	no
Largest suitable rearward facing fixture (R1/R2X/R2/R3)	no	no	R3	no	R3
Largest suitable forward facing fixture (F1/F2X/F2/F3)	no	no	F3	no	F3
Largest suitable booster fixture (B2/B3)	B3	B3	B3	no	B3

*1: When installing a child seat, adjust the seat slide to the most rear position and adjust the seat back angle to the most upright position.

The child seat with the support legs can also be attached for non i-size seating position.

▣ Locations for Child Restraint System Installation

When purchasing a child restraint systems, make sure to check the ISOFIX size class or the fixture to ensure that the seat is compatible with your vehicle.







Fixture (CRF)	Description
ISO/L2	Right lateral-facing (carrycot) infant seat
ISO/L1	Left lateral-facing (carrycot) infant seat
ISO/R1	Rearward-facing infant seat
ISO/R2	Reduced-size rearward-facing child restraint systems
ISO/R3	Full-size rearward-facing child restraint systems
ISO/F2X	Reduced-height forward-facing child restraint systems
ISO/F2	Reduced-height forward-facing child restraint systems
ISO/F3	Full-height, forward-facing child restraint systems
ISO/B2	Reduced width forward-facing booster seat
ISO/B3	Full width forward-facing booster seat

Continued

Locations for Child Restraint System Installation

7-seater



	Suitable for universal restraint systems installed with vehicle safety belts.
	Suitable for forward facing universal restraint systems installed with vehicle safety belts.
	Suitable for i-Size and ISOFIX child restraints systems.
	Suitable for forward facing restraint systems only.
	Never use a rearward facing child restraint system.
	Seat position equipped with Top Tether anchorages.

*1: When installing a child seat, adjust the seat slide to the most rear position and adjust the seat back angle to the most upright position.

*2: If you can not fix the child restraint system stably, adjust the seat back angle to be parallel with the back side of the child restraint system, still keeping it forward of the seat belt shoulder anchor.

*3: Move the second row seat to its slide rail rearmost position when the CRS is installed on the second row seat.

*4: When installing a booster child seat approved by UN R129, adjust the front and rear position of the second row seat forward five steps or five steps from the front most.

Seat position number	Seating position						
	①		②	③	④	⑤	⑥
	Front		2nd row			3rd row	
	Passenger Airbag ON/OFF switch		Left	Centre	Right	Left	Right
ON	OFF						
Seating position suitable for universal belted (yes/no)	yes ^{*1} Forward facing only	yes ^{*1}	yes	yes	yes	yes	yes
i-Size seating position (yes/no)	no	no	yes	no	yes	no	no
Seating position suitable for recommended child seat (yes/no)	yes	yes	yes	yes	yes	yes	yes
Seating position suitable for lateral fixture (L1/L2)	no	no	no	no	no	no	no
Largest suitable rearward facing fixture (R1/R2X/R2/R3)	no	no	R3	no	R3	no	no
Largest suitable forward facing fixture (F1/F2X/F2/F3)	no	no	F3	no	F3	no	no
Largest suitable booster fixture (B2/B3)	B3	B3	B3	no	B3	B3 ^{*2}	B3 ^{*2}

▣ Locations for Child Restraint System Installation

When purchasing a child restraint systems, make sure to check the ISOFIX size class or the fixture to ensure that the seat is compatible with your vehicle.

Fixture (CRF)	Description
ISO/L2	Right lateral-facing (carrycot) infant seat
ISO/L1	Left lateral-facing (carrycot) infant seat
ISO/R1	Rearward-facing infant seat
ISO/R2	Reduced-size rearward-facing child restraint systems
ISO/R3	Full-size rearward-facing child restraint systems
ISO/F2X	Reduced-height forward-facing child restraint systems
ISO/F2	Reduced-height forward-facing child restraint systems
ISO/F3	Full-height, forward-facing child restraint systems
ISO/B2	Reduced width forward-facing booster seat
ISO/B3	Full width forward-facing booster seat

Continued

*1: When installing a child seat, adjust the seat slide to the most rear position and adjust the seat back angle to the most upright position.

*2: When installing a booster child seat approved by UN R129, adjust the front and rear positions of the second row seat forward five steps or five steps from the front most.

The child seat with the support legs can also be attached to other non i-size seating positions except for the third row seat.

Europe Genuine CRS List

R44

Mass Group	Child Restraint System	Category
Group 0 up to 10kg	—	—
Group 0+ up to 13 kg	—	—
Group I 9 to 18kg	—	—
Group II, III 15 to 36 kg	Honda KIDFIX XP SICT	Universal Semi-universal

R129

Range of application	Child Restraint System	Category
40 to 83cm up to 13kg (Birth - 15 months)	Honda baby safe	Infant carrier module
	Honda baby safe ISOFIX	Base for i-Size
76 to 105cm 8 to 22kg (15 months - 4 years)	Honda ISOFIX	i-Size Universal ISOFIX

■ Installing a Lower Anchorage-Compatible Child Restraint System

A lower anchorage-compatible child restraint system can be installed in either of the two outer second row seats. A child restraint system is attached to the lower anchorages with either the rigid or flexible type of connectors.

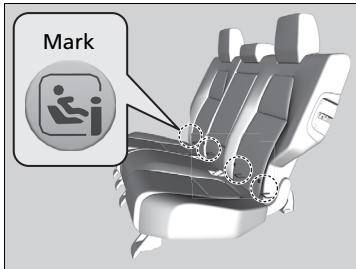

1. Locate the lower anchorages under the marks.

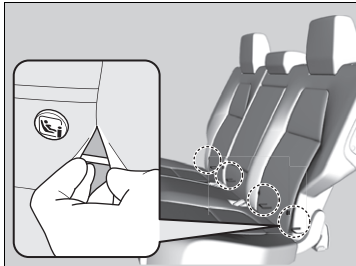

Models without third row seat

2. The lower anchorages are shown in the image.

▶▶ Installing a Lower Anchorage-Compatible Child Restraint System

⚠ WARNING

Never attach two child restraint system to the same anchor. In a collision, one anchor may not be strong enough to hold two child restraint system attachments and may break, causing serious injury or death.

Some child restraint systems come with optional guide-cups, which avoid possible damage to the seat surface. Follow the manufacturer's instructions when using the guide-cups, and attach them to the lower anchorages as shown in the image.

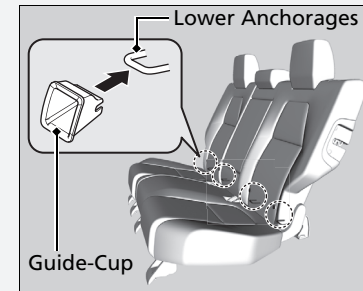

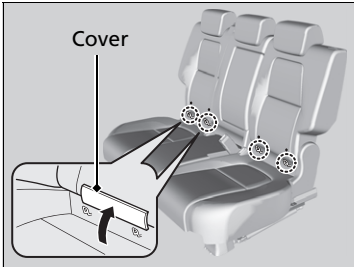

Models with third row seat

2. Pull out the anchor cover under the marks to expose the lower anchors.

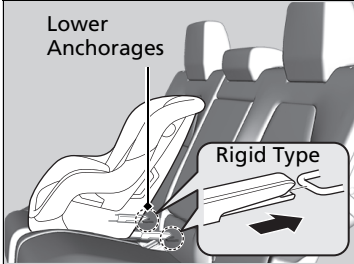

3. Place the child restraint system on the vehicle seat, then attach the child restraint system to the lower anchorages according to the instructions that came with the child restraint system.

▶ When installing the child restraint system, make sure that the lower anchorages are not obstructed by the seat belt or any other object.

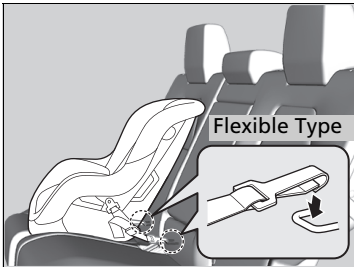

Installing a Lower Anchorage-Compatible Child Restraint System

For your child's safety, when using a child restraint system installed using the lower anchorage system, make sure that the child restraint system is properly secured to the vehicle.

A child restraint system that is not properly secured will not adequately protect a child in a crash and may cause injury to the child or other vehicle occupants.

The flexible type may not be available in your country.

If adults are to use the third row seats, the child restraint anchor fittings on the ceiling should not be installed.

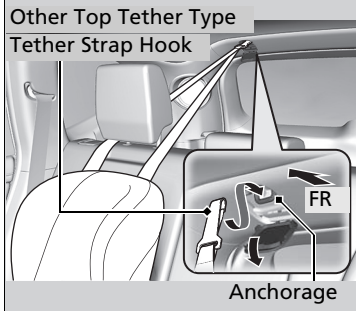
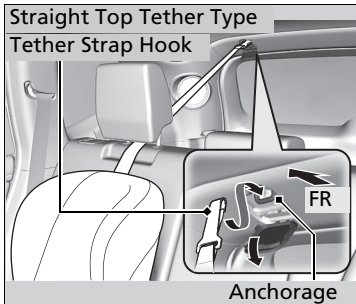
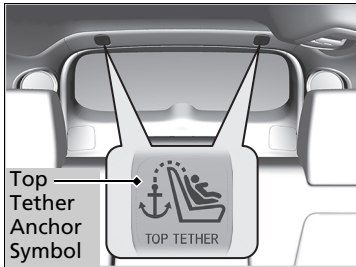

4. Open the tether anchorage cover.

Child restraint system with tether strap

5. Pull up the head restraint, and push it behind until it latches, then route the tether strap between the head restraint legs, and secure the tether strap hook to the anchorage.
6. Tighten the tether strap as instructed by the child restraint system manufacturer.
7. Make sure the child restraint system is firmly secured by rocking it forward and back, and side to side; little movement should be felt.
8. Make sure any unused seat belt that a child can reach is buckled.

▶▶ Installing a Lower Anchorage-Compatible Child Restraint System

WARNING: Never use a hook that does not come with a Top Tether anchor symbol when securing an installed child restraint system.

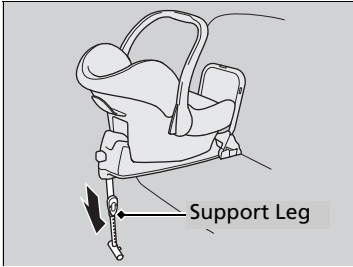
**Child restraint system with support leg**

5. Extend the support leg until it touches the floor as instructed by the child restraint system manufacturer.

- ▶ Confirm that the section of the floor on which the support leg rests is level. If the section is not level, the support leg will not provide adequate support.

Models with third row seat

If this is the case, move the seat forward or back so that the support leg is resting on a level section.

All models

- ▶ Make sure that there is no contact between the child restraint system and the seat in front of it.

Models with third row seat

- ▶ Make sure that the support leg is not resting on the slide rail or cover.

■ Installing a Child Restraint System with a Lap/Shoulder Seat Belt

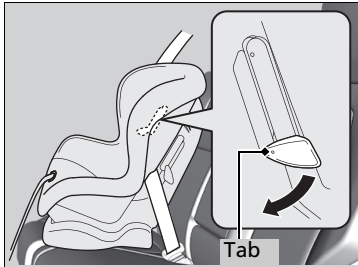

1. Place the child restraint system on the vehicle seat.
2. Route the seat belt through the child restraint system according to the child restraint system manufacturer's instructions, and insert the latch plate into the buckle.
 - ▶ Insert the latch plate fully until it clicks.
3. Push down the tab. Route the shoulder part of the belt into the slit at the side of the restraint.
4. Grab the shoulder part of the belt near the buckle, and pull up to remove any slack from the lap part of the belt.
 - ▶ When doing this, place your weight on child restraint system and push it into the vehicle seat.
5. Position the belt properly and push up the tab. Make sure the belt is not twisted.
 - ▶ When pushing up the tab, pull up the upper shoulder part of the belt to remove any slack from the belt.

▣ Installing a Child Restraint System with a Lap/Shoulder Seat Belt

A child restraint system that is not properly secured will not adequately protect a child in a crash and may cause injury to the child or other vehicle occupants.

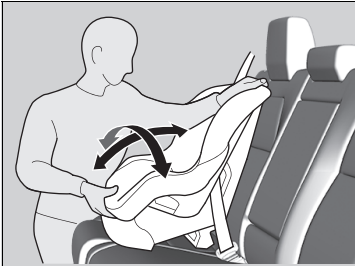

6. Make sure the child restraint system is firmly secured by rocking it forward and back, and side to side; little movement should be felt.
7. Make sure any unused seat belt that a child can reach is buckled.

Except European models

If your child restraint system does not come with a mechanism that secures the belt, install a locking clip on the seat belt.

After going through the step 1 and 2, pull up the shoulder part of the belt and make sure there is no slack in the lap portion.

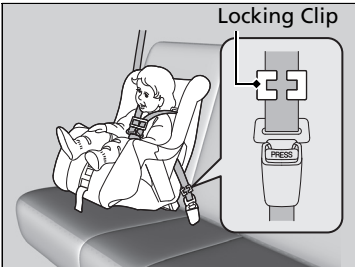

3. Tightly grasp the belt near the latch plate. Pinch both parts of the belt together so they do not slip through the latch plate. Unbuckle the seat belt.
4. Install the locking clip as shown in the image. Position the clip as close as possible to the latch plate.
5. Insert the latch plate into the buckle. Go to step 6 and 7.

■ Adding Security with a Tether

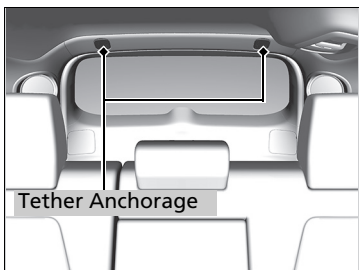

Two tether anchorage points are provided in the ceiling for the second row seating position. If you have a child restraint system that comes with a tether but can be installed with a seat belt, the tether may be used for additional security.

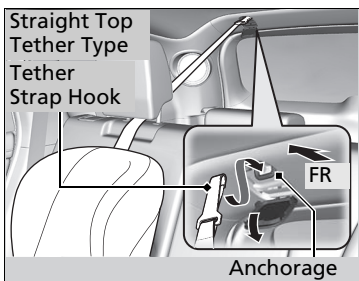

1. Pull up the head restraint and push rearward until it latches, then route the tether strap through the head restraint legs. Make sure the strap is not twisted.
2. Secure the tether strap hook to the anchorage.
3. Tighten the tether strap as instructed by the child restraint system manufacturer.

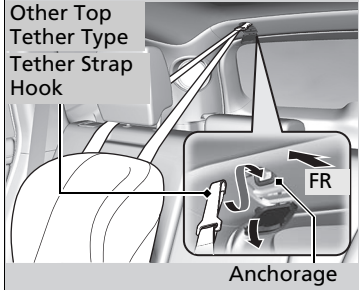

▣ Adding Security with a Tether

WARNING: Child restraint anchorages are designed to withstand only those loads imposed by correctly fitted child restraints. Under no circumstances are they to be used for adult seat belts, harnesses or for attaching other items or equipment to the vehicle.

Always use a tether for forward facing child restraint system when using the seat belt or lower anchors.

If adults are to use the third row seats, the child restraint anchor fittings on the ceiling should not be installed.

Safety of Larger Children

■ Protecting Larger Children

The following pages give instructions on how to check proper seat belt fit, what kind of booster seat to use if one is needed, and important precautions for a child who must sit in front.

■ Checking Seat Belt Fit

When a child is too big for a child restraint system, secure the child in a rear seat using the lap/shoulder seat belt. Have the child sit upright and all the way back, then answer the following questions.



■ Checklist

- Do the child's knees bend comfortably over the edge of the seat?
- Does the shoulder belt cross between the child's neck and arm?
- Is the lap part of the seat belt as low as possible, touching the child's thighs?
- Will the child be able to stay seated like this for the whole trip?

If you answer yes to all these questions, the child is ready to wear the lap/shoulder seat belt correctly. If you answer no to any question, the child needs to ride on a booster seat until the seat belt fits properly without a booster seat.

▶▶ Safety of Larger Children

⚠ WARNING

Allowing a child aged 12 or under to sit in front can result in injury or death if the passenger's front airbag inflates.

If a larger child must ride in front, move the vehicle seat as far to the rear as possible, have the child sit up properly and wear the seat belt properly, using a booster seat if needed.

Booster Seats



If a lap/shoulder seat belt cannot be used properly, position the child in a booster seat in the rear seat. For the child's safety, check that the child meets the booster seat manufacturer's recommendations.

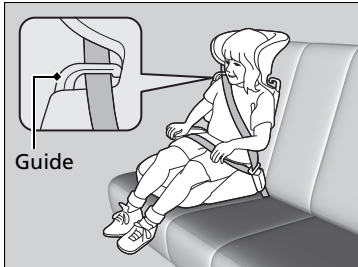

A backrest is available for a specific booster seat. Install the backrest to the booster seat and adjust it to the vehicle seat according to the booster seat manufacturer's instructions. Make sure the seat belt is properly routed through the guide at the shoulder of the backrest and the belt does not touch and cross the child's neck.

Booster Seats

When installing a booster seat, make sure to read the instructions that came with it, and install the seat accordingly.

There are high- and low-type booster seats. Choose a booster seat that allows the child to wear the seat belt correctly.

We recommend a booster seat with a backrest as it is easier to adjust the shoulder belt.

■ Protecting Larger Children - Final Checks

Your vehicle has a rear seat where children can be properly restrained. If you ever have to carry a group of children, and a child must ride in front:

- Make sure you read and fully understand the instructions and safety information in this manual.
- Move the front passenger seat as far back as possible.
- Have the child sit upright and well back in the seat.
- Check that the seat belt is properly positioned so that the child is secure in the seat.

■ Monitoring child passengers

We strongly recommend that you keep an eye on child passengers. Even older, more mature children sometimes need to be reminded to fasten their seat belts and sit up properly.

Carbon Monoxide Gas

The engine exhaust from this vehicle contains carbon monoxide, a colourless, odourless, and highly toxic gas. As long as you properly maintain your vehicle, carbon monoxide gas will not get into the interior.

■ Have the exhaust system inspected for leaks whenever

- The exhaust system is making an unusual noise.
- The exhaust system may have been damaged.
- The vehicle is raised for an oil change.

When you operate a vehicle with the tailgate open, airflow can pull exhaust gas into the interior and create a hazardous condition. If you must drive with the tailgate open, open all the windows and set the climate control system as shown below.

1. Select the fresh air mode.
2. Select the  mode.
3. Set the fan speed to high.
4. Set the temperature control to a comfortable setting.

Adjust the climate control system in the same manner if you sit in your parked vehicle with the engine running.

ⓘ Carbon Monoxide Gas

WARNING

Carbon monoxide gas is toxic.

Breathing it can cause unconsciousness and even kill you.

Avoid any enclosed areas or activities that expose you to carbon monoxide.

An enclosed area such as a garage can quickly fill up with carbon monoxide gas. Do not run the engine with the garage door closed. Even when the garage door is open, drive out of the garage immediately after starting the engine.

Label Locations

These labels are in the locations shown. They warn you of potential hazards that can cause serious injury or death. Read these labels carefully.

If a label comes off or becomes hard to read, contact a dealer for a replacement.

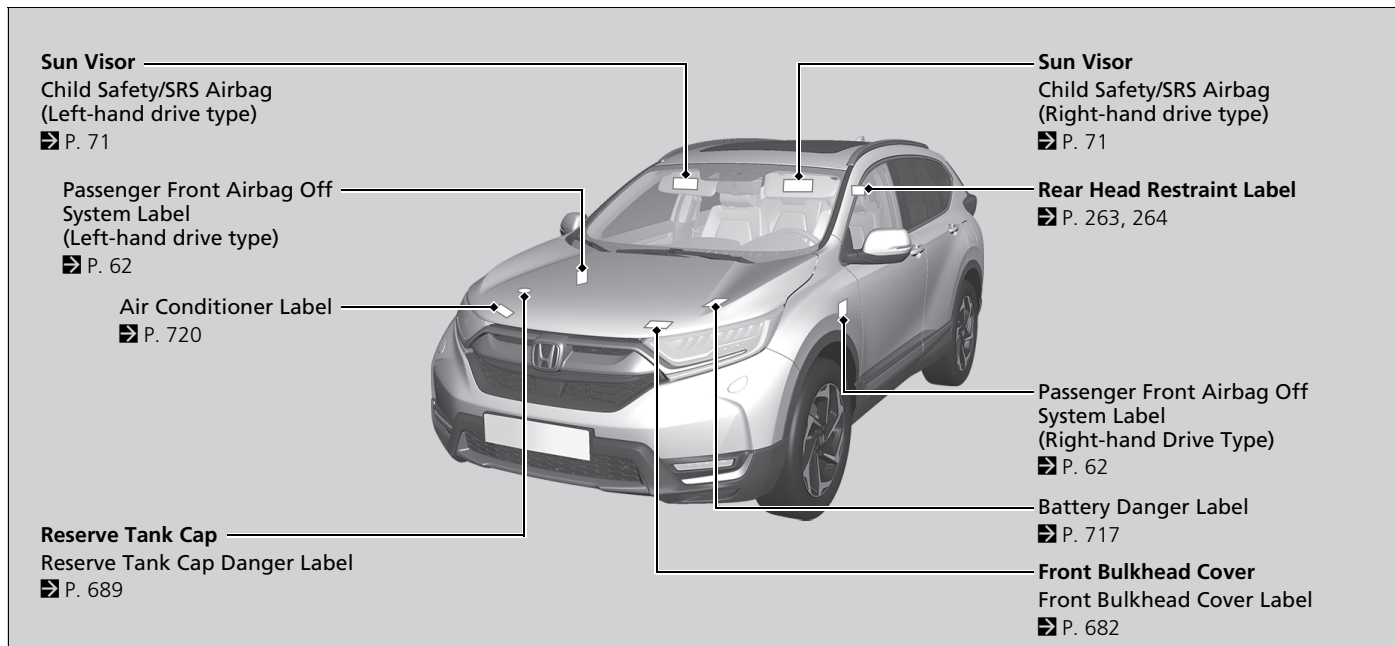







Instrument Panel

This chapter describes the buttons, indicators, and gauges that are used while driving.











Indicators	98
Driver Information Interface Warning and Information Messages.....	122
Gauges and Driver Information Interface	
Gauges.....	147
Driver Information Interface	148
Head-up Display*	170









* Not available on all models

Indicator	Name	On/Blinking	Explanation	Message
 (Red)	Parking Brake and Brake System Indicator (Red)	<ul style="list-style-type: none"> • Comes on for a few seconds when you turn the ignition switch to ON *1, then goes off if the parking brake has been released. • Comes on when the parking brake is applied and goes off when it is released. • Comes on when the brake fluid level is low. • Comes on if there is a problem with the brake system. • The beeper sounds and the indicator comes on if you drive with the parking brake not fully released. 	<ul style="list-style-type: none"> • Comes on while driving - Make sure the parking brake is released. Check the brake fluid level. <ul style="list-style-type: none"> ➤ What to do when the indicator comes on while driving P. 753 • Comes on along with the parking brake and brake system indicator (amber) - Immediately stop in a safe place. Contact a dealer for repair. The brake pedal becomes harder to operate. Depress the pedal further than you normally do. • Comes on along with the ABS indicator - Have your vehicle checked by a dealer. <ul style="list-style-type: none"> ➤ If the Brake System Indicator (Red) Comes On or Blinks P. 753 	   







*1: Models with the keyless access system have an **ENGINE START/STOP** button instead of an ignition switch.

Indicator	Name	On/Blinking	Explanation	Message
 (Red)	Parking Brake and Brake System Indicator (Red)	<ul style="list-style-type: none"> • Comes on for about 15 seconds when you pull the electric parking brake switch while the ignition switch is in LOCK *1. • Stays on for about 15 seconds when you turn the ignition switch to LOCK *1 while the electric parking brake is set. 	<ul style="list-style-type: none"> • Blinks and the parking brake and brake system indicator (amber) comes on at the same time - There is a problem with the electric parking brake system. The parking brake may not be set. Avoid using the parking brake and have your vehicle checked by a dealer immediately. ➤ If the Brake System Indicator (Red) Comes On or Blinks at the Same Time When the Brake System Indicator (Amber) Comes On P. 754 	—
	Automatic Brake Hold System Indicator	<ul style="list-style-type: none"> • Comes on for a few seconds when you turn the ignition switch to ON *1, then goes off. • Comes on when the automatic brake hold system is on. 	<ul style="list-style-type: none"> ➤ Automatic Brake Hold P. 634 	
	Automatic Brake Hold Indicator	<ul style="list-style-type: none"> • Comes on for a few seconds when you turn the ignition switch to ON *1, then goes off. • Comes on when the automatic brake hold is activated. 	<ul style="list-style-type: none"> ➤ Automatic Brake Hold P. 634 	—



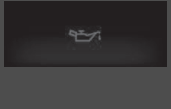







*1: Models with the keyless access system have an **ENGINE START/STOP** button instead of an ignition switch.

Indicator	Name	On/Blinking	Explanation	Message
 (Amber)	Parking Brake and Brake System Indicator (Amber)	<ul style="list-style-type: none"> • Comes on for a few seconds when you turn the ignition switch to ON *1, then goes off. • Comes on if there is a problem with a system related to braking other than the conventional brake system. • Comes on if there is a problem with the electric parking brake system or the automatic brake hold system. 	<ul style="list-style-type: none"> • Stays on constantly - Have your vehicle checked by a dealer. • Comes on while driving - Avoid using the parking brake and have your vehicle checked by a dealer immediately. 	    
		<ul style="list-style-type: none"> • Comes on if the parking brake and brake system is deactivated temporarily after the battery has been disconnected, then reconnected. 	<ul style="list-style-type: none"> • Drive a short distance at more than 20 km/h (12 mph). The indicator should go off. If it does not, have your vehicle checked by a (Amber) dealer. 	
		<ul style="list-style-type: none"> • Comes on if there is a problem with the radar sensor. • Indicator may come on temporarily when the Maximum Load Limit is exceeded. 	<ul style="list-style-type: none"> • Make sure the total load is within the Maximum Load Limit.  Load Limit P. 503 • Stays on constantly - Have your vehicle checked by a dealer. 	—









*1: Models with the keyless access system have an **ENGINE START/STOP** button instead of an ignition switch.

Indicator	Name	On/Blinking	Explanation	Message
	Low Oil Pressure Indicator	<ul style="list-style-type: none"> • Comes on when you turn the ignition switch to ON ^{*1}, and goes off when the engine starts. • Comes on when the engine oil pressure is low. 	<ul style="list-style-type: none"> • Comes on while driving - Immediately stop in a safe place.  If the Low Oil Pressure Indicator Comes On P. 751 	
	Malfunction Indicator Lamp	<ul style="list-style-type: none"> • Comes on when you turn the ignition switch to ON ^{*1}, and goes off either when the engine starts, or after several seconds if the engine did not start. • Comes on if there is a problem with the emissions control systems. • Blinks when a misfire in the engine's cylinders is detected. 	<ul style="list-style-type: none"> • Comes on while driving - Have your vehicle checked by a dealer. • Shows the self-testing condition of the diagnostics of the emission control system. • Blinks while driving - Stop in a safe place where there are no flammable objects. Stop the engine for 10 minutes or more, and wait for it to cool down. Then, take the vehicle to a dealer.  If the Malfunction Indicator Lamp Comes On or Blinks P. 752 	

*1: Models with the keyless access system have an **ENGINE START/STOP** button instead of an ignition switch.







Indicator	Name	On/Blinking	Explanation	Message
	Charging System Indicator	<ul style="list-style-type: none"> Comes on when you turn the ignition switch to ON *¹, and goes off when the engine starts. Comes on when the battery is not charging. 	<ul style="list-style-type: none"> Comes on while driving - Turn off the climate control system and rear demister in order to reduce electricity consumption. <ul style="list-style-type: none"> ☞ If the Charging System Indicator Comes On P. 751 	
	Shift Lever Position Indicator*	<ul style="list-style-type: none"> Indicates the current shift lever position. 	<ul style="list-style-type: none"> ☞ Shifting P. 523 	—
	Transmission System Indicator*	<ul style="list-style-type: none"> Comes on for a few seconds when you turn the ignition switch to ON *¹, then goes off. Blinks if the transmission system has a problem. 	<ul style="list-style-type: none"> Blinks while driving - Avoid sudden starts and acceleration and have your vehicle checked by a dealer immediately. 	
	Shift Up Indicator	<ul style="list-style-type: none"> Comes on when shifting up is recommended. 	<ul style="list-style-type: none"> ☞ Shift Up Indicator P. 527 ☞ Shift Up/Down Indicators P. 529 	—
	Shift Down Indicator*	<ul style="list-style-type: none"> Comes on when shifting down is recommended. 	<ul style="list-style-type: none"> ☞ Shift Up/Down Indicators P. 529 	—
	M (7-speed manual shift mode) Indicator/Shift Indicator*	<ul style="list-style-type: none"> Comes on when 7-speed manual shift mode is applied. 	<ul style="list-style-type: none"> ☞ 7-Speed Manual Shift Mode P. 525 	—

*1:Models with the keyless access system have an **ENGINE START/STOP** button instead of an ignition switch.

Indicator	Name	On/Blinking	Explanation	Message
	Seat Belt Reminder Indicator	<ul style="list-style-type: none"> Comes on if you are not wearing a seat belt when you turn the ignition switch to ON II*1. If the front passenger is not wearing a seat belt, the indicator comes on a few seconds later. Blinks while driving if either you or the front passenger has not fastened a seat belt. The beeper sounds and the indicator blinks at regular intervals. 	<ul style="list-style-type: none"> The beeper stops and the indicator goes off when you and the front passenger fasten their seat belts. Stays on after you or the front passenger has fastened the seat belt - A detection error may have occurred in the sensor. Have your vehicle checked by a dealer. ➤ Seat Belt Reminder P. 45 	 (Red) 
	Low Fuel Indicator	<ul style="list-style-type: none"> Comes on when the fuel reserve is running low (approximately 8.0 litres/1.76 Imp gal left). Blinks if there is a problem with the fuel gauge. 	<ul style="list-style-type: none"> Comes on - Refuel your vehicle as soon as possible. Blinks - Have your vehicle checked by a dealer. 	 
	Anti-lock Brake System (ABS) Indicator	<ul style="list-style-type: none"> Comes on for a few seconds when you turn the ignition switch to ON II*1, then goes off. If it comes on at any other time, there is a problem with the ABS. 	<ul style="list-style-type: none"> Stays on constantly - Have your vehicle checked by a dealer. With this indicator on, your vehicle still has normal braking ability but no anti-lock function. ➤ Anti-lock Brake System (ABS) P. 637 	

Instrument Panel

*1: Models with the keyless access system have an **ENGINE START/STOP** button instead of an ignition switch.





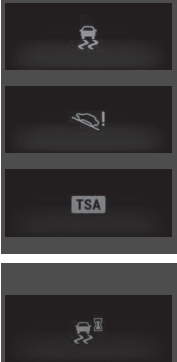

Indicator	Name	On/Blinking	Explanation	Message
	Supplemental Restraint System Indicator	<ul style="list-style-type: none"> • Comes on for a few seconds when you turn the ignition switch to ON *1, then goes off. • Comes on if a problem with any of the following is detected: <ul style="list-style-type: none"> - Supplemental restraint system - Side airbag system - Side curtain airbag system - Seat belt tensioner 	<ul style="list-style-type: none"> • Stays on constantly or does not come on at all - Have your vehicle checked by a dealer. 	
	Passenger Front Airbag On/Off Indicators	<ul style="list-style-type: none"> • Both indicators come on for a few seconds when you turn the ignition switch to ON *1, then goes off after a system check up. <p>When the passenger front airbag is active: The on indicator comes back on and remains on for about 60 seconds.</p> <p>When the passenger front airbag is inactive: The off indicator comes back on and stays on. This is a reminder that the passenger front airbag is deactivated.</p>	<p> Passenger Front Airbag Off System P. 61</p>	

*1: Models with the keyless access system have an **ENGINE START/STOP** button instead of an ignition switch.



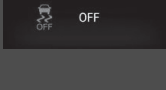
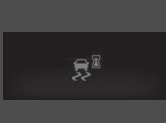

Indicator	Name	On/Blinking	Explanation	Message
	Vehicle Stability Assist (VSA) System Indicator	<ul style="list-style-type: none"> • Comes on for a few seconds when you turn the ignition switch to ON II*1, then goes off. • Blinks when VSA, or trailer stability assist is active. • Comes on if there is a problem with the VSA system, brake assist, hill start assist system, trailer stability assist or brake lighting system. • Comes on if the VSA system is deactivated temporarily after the battery has been disconnected, then re-connected. 	<ul style="list-style-type: none"> • Stays on constantly - Have your vehicle checked by a dealer. <ul style="list-style-type: none"> ➤ Vehicle Stability Assist (VSA) System P. 547 ➤ Hill start assist system P. 516 ➤ Trailer Stability Assist P. 508 • When TSA is displayed on the driver information interface, the VSA does not activate. • Drive a short distance at more than 20 km/h (12 mph). The indicator should go off. If it does not, have your vehicle checked by a dealer. 	

Instrument Panel





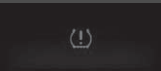
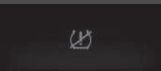

*1: Models with the keyless access system have an **ENGINE START/STOP** button instead of an ignition switch.

Indicator	Name	On/Blinking	Explanation	Message
	Vehicle Stability Assist (VSA) OFF Indicator	<ul style="list-style-type: none"> Comes on for a few seconds when you turn the ignition switch to ON *1, then goes off. Comes on when you partially disable VSA. 	<ul style="list-style-type: none">  VSA On and Off P. 548 	
		<ul style="list-style-type: none"> Comes on if the VSA system is deactivated temporarily after the battery has been disconnected, then re-connected. 	<ul style="list-style-type: none"> Drive a short distance at more than 20 km/h (12 mph). The indicator should go off. If it does not, have your vehicle checked by a dealer. 	
	Electric Power Steering (EPS) System Indicator	<ul style="list-style-type: none"> Comes on when you turn the ignition switch to ON *1, and goes off when the engine starts. Comes on if there is a problem with the EPS System. 	<ul style="list-style-type: none"> Stays on constantly or does not come on at all - Have your vehicle checked by a dealer.  If the Electric Power Steering (EPS) System Indicator Comes On P. 755 	





*1: Models with the keyless access system have an **ENGINE START/STOP** button instead of an ignition switch.

Indicator	Name	On/Blinking	Explanation	Message
	Low Tyre Pressure/Deflation Warning System Indicator	<ul style="list-style-type: none"> • Comes on for a few seconds when you turn the ignition switch to ON ^{*1}, then goes off. • May come on briefly if the ignition switch is turned to ON ^{*1} and the vehicle is not moved within 45 seconds, to indicate the initialisation process is not yet complete. • Comes on and stays on when: <ul style="list-style-type: none"> - One or more tyres' pressures are determined to be significantly low. - The system has not been initialised. 	<ul style="list-style-type: none"> • Comes on while driving - Stop in a safe place, check tyre pressures, and inflate the tyre(s) if necessary. • Stays on after the tyres are inflated to the recommended pressures - The system needs to be initialised. <ul style="list-style-type: none"> ➤ Deflation Warning System Initialisation P. 551 	
		<ul style="list-style-type: none"> • Blinks for about one minute, and then stays on if there is a problem with the deflation warning system, or when a compact spare tyre is temporarily installed. 	<ul style="list-style-type: none"> • Blinks and remains on - Have your vehicle checked by a dealer. If the vehicle is fitted with a compact spare, get your regular tyre repaired or replaced and put back on your vehicle as soon as you can. 	
		<ul style="list-style-type: none"> • Comes on if the deflation warning system is deactivated temporarily after the battery has been disconnected, then re-connected. 	<ul style="list-style-type: none"> • Drive a short distance at more than 20 km/h (12 mph). The indicator should go off. If it does not, have your vehicle checked by a dealer. 	

* 1: Models with the keyless access system have an **ENGINE START/STOP** button instead of an ignition switch.







Indicator	Name	On/Blinking	Explanation	Message
	System Message Indicator	<ul style="list-style-type: none"> • Comes on for a few seconds when you turn the ignition switch to ON *1, then goes off. • Comes on along with a beep when a problem is detected. A system message on the driver information interface appears at the same time. 	<ul style="list-style-type: none"> • While the indicator is on, press the  (display/information) button to see the message again. • Refer to the Indicators information in this chapter when a system message appears on the driver information interface. Take the appropriate action for the message. • The driver information interface does not return to the normal screen unless the warning is cancelled, or the  button is pressed. 	—
	Auto High-Beam Indicator	<ul style="list-style-type: none"> • Comes on when all the operating conditions of the auto high-beam are met. 	<p> Auto High-Beam (High Beam Support System) P. 229</p>	—

*1: Models with the keyless access system have an **ENGINE START/STOP** button instead of an ignition switch.





Indicator	Name	On/Blinking	Explanation	Message
	Turn Signal and Hazard Warning Indicators	<ul style="list-style-type: none"> Blinks when you operate the turn signal lever. Blink along with all turn signals if you press the hazard warning button. 	<ul style="list-style-type: none"> Does not blink or blinks rapidly - A turn signal light bulb has blown. Change the bulb immediately. <ul style="list-style-type: none"> ➤ Replacing Light Bulbs P. 697 	—
		<ul style="list-style-type: none"> Blink along with all turn signals when you depress the brake pedal while the high speed driving. 	<ul style="list-style-type: none"> ➤ Emergency Stop Signal P. 639 	
	High Beam Indicator	<ul style="list-style-type: none"> Comes on when the high beam headlights are on. 	—	—
	Lights On Indicator	<ul style="list-style-type: none"> Comes on whenever the light switch is on, or in AUTO when the exterior lights are on. 	<ul style="list-style-type: none"> If you remove the key from the ignition switch*¹ while the lights are on, a chime sounds when the driver's door is opened. 	—
	Front Fog Light Indicator*	<ul style="list-style-type: none"> Comes on when the front fog lights are on. 	—	—
	Rear Fog Light Indicator	<ul style="list-style-type: none"> Comes on when the rear fog light is on. 	—	—

*1: Models with the keyless access system have an **ENGINE START/STOP** button instead of an ignition switch.

Instrument Panel



Indicator	Name	On/Blinking	Explanation	Message
	<p>Immobilizer System Indicator</p>	<ul style="list-style-type: none"> Blinks if the immobilizer system cannot recognize the key information. 	<ul style="list-style-type: none"> Blinks - You cannot start the engine. Turn the ignition switch to LOCK 0*1, pull the key out, and then insert the key and turn it to ON II*1 again. <ul style="list-style-type: none"> Right-hand drive type Strongly depress and hold the brake and/or clutch pedal before turning the ignition switch to ON II*1. All models Repeatedly blinks - The system may be malfunctioning. Have your vehicle checked by a dealer. Do not attempt to alter this system or add other devices to it. Electrical problems can occur. 	<p>Models without keyless access system</p>    <p>Models with keyless access system</p>   



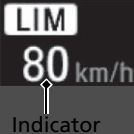

*1: Models with the keyless access system have an **ENGINE START/STOP** button instead of an ignition switch.

Indicator	Name	On/Blinking	Explanation	Message
 <p>Indicator</p> 	<p>Security System Alarm Indicator</p>	<ul style="list-style-type: none"> Blinks when the security system alarm has been set. 	<p>➤ Security System Alarm P. 205</p>	
	<p>ECON Mode Indicator</p>	<ul style="list-style-type: none"> Comes on when ECON mode is on. 	<p>➤ ECON Mode P. 531</p>	

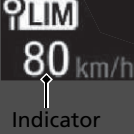

Indicator	Name	On/Blinking	Explanation	Message
	Auto Idle Stop Indicator (Green)*	<ul style="list-style-type: none"> Comes on when Auto Idle Stop is in operation. The engine automatically shuts off. 	<ul style="list-style-type: none"> Auto Idle Stop P. 532 	
		<ul style="list-style-type: none"> Blinks when the ambient conditions may cause the windows to fog up. Blinks when the ambient conditions may become different from the climate control settings you have selected. Blinks when the button is pressed. 	<ul style="list-style-type: none"> Depress the clutch pedal. The engine automatically restarts. Auto Idle Stop P. 532 	
	Auto Idle Stop System Indicator (Amber)*	<ul style="list-style-type: none"> Comes on for a few seconds when you turn the ignition switch to ON *1, then goes off. 	—	
		<ul style="list-style-type: none"> Comes on when the Auto Idle Stop system has been turned off by the Auto Idle Stop system OFF button. Blinks if there is a problem with the Auto Idle Stop system. 	<ul style="list-style-type: none"> Auto Idle Stop System ON/OFF P. 533 Blinks - Have your vehicle checked by a dealer. 	

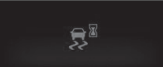

*1: Models with the keyless access system have an **ENGINE START/STOP** button instead of an ignition switch.



Indicator	Name	On/Blinking	Explanation	Message
	Adjustable Speed Limiter Indicator	<ul style="list-style-type: none"> Comes on when you press the MAIN button. If a different indicator comes on, subsequently press the LIM button. 	<ul style="list-style-type: none"> ➤ Adjustable Speed Limiter P. 536 	—
 Indicator	Adaptive Cruise Control (ACC) and Adjustable Speed Limiter Set Speed Indicator	<ul style="list-style-type: none"> Comes on when you have set a speed for cruise control. Comes on when you have set a speed for adjustable speed limiter. 	<ul style="list-style-type: none"> ➤ Adaptive Cruise Control (ACC) with Low Speed Follow (LSF) P. 572 ➤ Adaptive Cruise Control (ACC) P. 589 ➤ Adjustable Speed Limiter P. 536 	—
	Intelligent Speed Limiter Indicator	<ul style="list-style-type: none"> Comes on when you press the MAIN button. If a different indicator comes on, subsequently press the LIM button. 	<ul style="list-style-type: none"> ➤ Intelligent Speed Limiter P. 540 	—
 Indicator	Adaptive Cruise Control (ACC) and Intelligent Speed Limiter Set Speed Indicator	<ul style="list-style-type: none"> Comes on when the intelligent speed limiter is set to the speed limit that the traffic sign recognition system detects. Comes on when you have set a speed for intelligent speed limiter. 	<ul style="list-style-type: none"> ➤ Adaptive Cruise Control (ACC) with Low Speed Follow (LSF) P. 572 ➤ Adaptive Cruise Control (ACC) P. 589 ➤ Intelligent Speed Limiter P. 540 	—

Indicator	Name	On/Blinking	Explanation	Message
	Road Departure Mitigation Indicator	<ul style="list-style-type: none"> • Comes on for a few seconds when you turn the ignition switch to ON *1, then goes off. • Comes on if there is a problem with the road departure mitigation system. 	<ul style="list-style-type: none"> • Stays on constantly - Have your vehicle checked by a dealer. 	
		<ul style="list-style-type: none"> • Comes on if the road departure mitigation system is deactivated temporarily after the battery has been disconnected, then re-connected. 	<ul style="list-style-type: none"> • Drive a short distance at more than 20 km/h (12 mph). The indicator should go off. If it does not, have your vehicle checked by a dealer. 	
		<ul style="list-style-type: none"> • Indicator may comes on temporarily when the Maximum Load Limit is exceeded. 	<ul style="list-style-type: none"> • Make sure the total load is within the Maximum Load Limit. <ul style="list-style-type: none"> ► Load Limit P. 503 • Stays on constantly - Have your vehicle checked by a dealer. 	

*1: Models with the keyless access system have an **ENGINE START/STOP** button instead of an ignition switch.



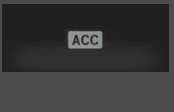
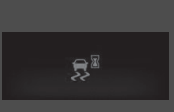



Indicator	Name	On/Blinking	Explanation	Message
	Road Departure Mitigation Indicator	<ul style="list-style-type: none"> • Comes on when the road departure mitigation system shuts itself off. 	<ul style="list-style-type: none"> • Indicator may come on temporarily when passing through an enclosed space, such as a tunnel. • The area around the radar sensor is blocked by dirt, mud, etc. Stop your vehicle in a safe place, and wipe it off with a soft cloth. • Have your vehicle checked by a dealer if the indicator does not go off even after you cleaned the radar sensor. <p>➤ Collision Mitigation Braking System (CMBS) P. 561</p>	
			<ul style="list-style-type: none"> • Stays on - The temperature inside the camera is too high. Use the climate control system to cool down the camera. The system activates when the temperature inside the camera cools down. <p>➤ Front Sensor Camera P. 626</p>	

Indicator	Name	On/Blinking	Explanation	Message
	Road Departure Mitigation Indicator	<ul style="list-style-type: none"> • Comes on when the road departure mitigation system shuts itself off. 	<ul style="list-style-type: none"> • Stays on - The area around the camera is blocked by dirt, mud, etc. Stop your vehicle in a safe place, and wipe it off with a soft cloth. • Have your vehicle checked by a dealer if the indicator and message come back on after you cleaned the area around the camera.  Front Sensor Camera P. 626 	









Indicator	Name	On/Blinking	Explanation	Message
ACC	Adaptive Cruise Control (ACC) with Low Speed Follow (LSF)* Indicator (Amber)	<ul style="list-style-type: none"> Comes on for a few seconds when you turn the ignition switch to ON *¹, then goes off. Comes on if there is a problem with ACC with LSF*. 	<ul style="list-style-type: none"> Comes on while driving - Have your vehicle checked by a dealer. 	
		<ul style="list-style-type: none"> Comes on if the ACC with LSF* is deactivated temporarily after the battery has been disconnected, then re-connected. 	<ul style="list-style-type: none"> Drive a short distance at more than 20 km/h (12 mph). The indicator should go off. If it does not, have your vehicle checked by a dealer. 	
		<ul style="list-style-type: none"> Indicator may come on temporarily when the Maximum Load Limit is exceeded. ACC with LSF* has been automatically cancelled. 	<ul style="list-style-type: none"> Make sure the total load is within the Maximum Load Limit. <ul style="list-style-type: none"> ➤ Load Limit P. 503 Stays on constantly - Have your vehicle checked by a dealer. 	
ACC	Adaptive Cruise Control (ACC) with Low Speed Follow (LSF)* Indicator (Green)	<ul style="list-style-type: none"> Comes on when you press the MAIN button. 	<ul style="list-style-type: none"> ➤ Adaptive Cruise Control (ACC) with Low Speed Follow (LSF) P. 572 ➤ Adaptive Cruise Control (ACC) P. 589 	

*1: Models with the keyless access system have an **ENGINE START/STOP** button instead of an ignition switch.

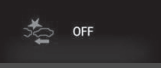
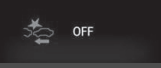
* Not available on all models





Indicator	Name	On/Blinking	Explanation	Message
	Lane Keeping Assist System (LKAS) Indicator (Amber)	<ul style="list-style-type: none"> Comes on for a few seconds when you turn the ignition switch to ON *1, then goes off. Comes on if there is a problem with the LKAS. 	<ul style="list-style-type: none"> Stays on constantly - Have your vehicle checked by a dealer. 	
	Lane Keeping Assist System (LKAS) Indicator (Green)	<ul style="list-style-type: none"> Comes on when you press the MAIN button. 	 Lane Keeping Assist System (LKAS) P. 604	



*1: Models with the keyless access system have an **ENGINE START/STOP** button instead of an ignition switch.

Indicator	Name	On/Blinking	Explanation	Message
	Collision Mitigation Braking System (CMBS) Indicator	<ul style="list-style-type: none"> • Comes on for a few seconds when you turn the ignition switch to ON *1, then goes off. • Comes on when you deactivate the CMBS. A driver information interface message appears for five seconds. • Comes on if there is a problem with the CMBS. 	<ul style="list-style-type: none"> • Stays on constantly without the CMBS off - Have your vehicle checked by a dealer.  <ul style="list-style-type: none"> ► Collision Mitigation Braking System (CMBS) P. 561 	
		<ul style="list-style-type: none"> • Comes on if the CMBS is deactivated temporarily after the battery has been disconnected, then re-connected. 	<ul style="list-style-type: none"> • Drive a short distance at more than 20 km/h (12 mph). The indicator should go off. If it does not, have your vehicle checked by a dealer. 	
		<ul style="list-style-type: none"> • Indicator may come on temporarily when the Maximum Load Limit is exceeded. 	<ul style="list-style-type: none"> • Make sure the total load is within the Maximum Load Limit.  Load Limit P. 503 • Stays on constantly - Have your vehicle checked by a dealer. 	
		<ul style="list-style-type: none"> • Comes on when the CMBS system shuts itself off. 	<ul style="list-style-type: none"> • Stays on - The area around the camera is blocked by dirt, mud, etc. Stop your vehicle in a safe place, and wipe it off with a soft cloth.  Front Sensor Camera P. 626 • Have your vehicle checked by a dealer if the indicator does not go off even after you cleaned the camera.  Collision Mitigation Braking System (CMBS) P. 561 	

Instrument Panel

*1: Models with the keyless access system have an **ENGINE START/STOP** button instead of an ignition switch.

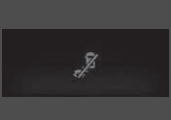
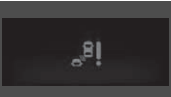

Indicator	Name	On/Blinking	Explanation	Message
	Collision Mitigation Braking System (CMBS) Indicator	<ul style="list-style-type: none"> Comes on when the CMBS system shuts itself off. 	<ul style="list-style-type: none"> Stays on - The temperature inside the camera is too high. Use the climate control system to cool down the camera. The system activates when the temperature inside the camera cools down.  Front Sensor Camera P. 626 	
			<ul style="list-style-type: none"> Indicator may come on temporarily when passing through an enclosed space, such as a tunnel. The area around the radar sensor is blocked by dirt, mud, etc. Stop your vehicle in a safe place, and wipe it off with a soft cloth. Have your vehicle checked by a dealer if the indicator does not go off even after you cleaned the radar sensor.  Collision Mitigation Braking System (CMBS) P. 561 	

Indicator	Name	On/Blinking	Explanation	Message
	Blind spot information System Indicator*	<ul style="list-style-type: none"> • Comes on for a few seconds when you set the power mode to ON, then goes off. • Stays on while the blind spot information system is turned off. 	—	
		<ul style="list-style-type: none"> • Comes on when mud, snow, or ice accumulates in the vicinity of sensor. 	<ul style="list-style-type: none"> • Comes on while driving - Remove the obstacle in the vicinity of sensor.  Blind spot information System* P. 555 	
		<ul style="list-style-type: none"> • Comes on if there is a problem with the system. 	<ul style="list-style-type: none"> • Comes on while driving - Have your vehicle checked by a dealer. 	

* Not available on all models

Driver Information Interface Warning and Information Messages

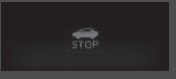
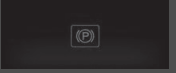

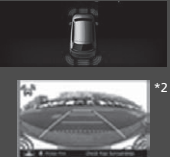
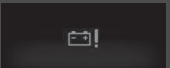

The following messages appear only on the driver information interface. Press the  (display/information) button to see the message again with the system message indicator on.

Message	Condition	Explanation
	<ul style="list-style-type: none"> Appears when the vehicle is no longer able to run due to a malfunction. 	<ul style="list-style-type: none"> Immediately stop in a safe place.
 (Amber)	<ul style="list-style-type: none"> Appears when there is a risk that the vehicle will move unexpectedly after you have stopped due to a malfunction with the vehicle. 	<ul style="list-style-type: none"> While the vehicle is stopped, apply the parking brake.  Parking Brake P. 629 Have your vehicle checked by a dealer.
	<ul style="list-style-type: none"> Appears if any door or the tailgate is not completely closed. Appears if any door or the tailgate is opened while driving. The beeper sounds. 	<ul style="list-style-type: none"> Goes off when all doors and the tailgate are closed.



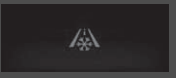

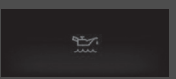

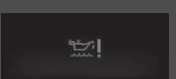
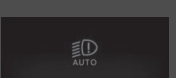
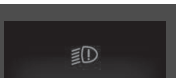
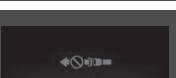

Message	Condition	Explanation
	<p>Models with parking sensor system</p> <ul style="list-style-type: none"> • Appears if there is a problem with the parking sensor system. • If there is a problem with any of the sensors, the all sensor indicator(s) comes on in red. 	<ul style="list-style-type: none"> • Check if the area around the sensor(s) is covered with mud, ice, snow, etc. If the indicator(s) stays on or the beeper does not stop even after you clean the area, have the system checked by a dealer.
	<ul style="list-style-type: none"> • Appears when there is a problem with the sensor on the battery. • Appears along with the battery charging system indicator when the battery is not charging. 	<ul style="list-style-type: none"> • Have your vehicle checked by a dealer. <ul style="list-style-type: none"> ▶ Checking the Battery P. 712 • Turn off the climate control system and rear demister to reduce electricity consumption. <ul style="list-style-type: none"> ▶ If the Charging System Indicator Comes On P. 751

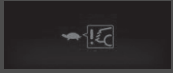
*1:Driver information interface





*2:Audio/Information screen





Message	Condition	Explanation
	<ul style="list-style-type: none"> Appears once if the outside temperature is below 3°C while the ignition switch is in ON *1. 	<ul style="list-style-type: none"> There is a possibility that the road surface is icy and slippery.
	<ul style="list-style-type: none"> Appears when the engine oil level is low while the engine is running. 	<ul style="list-style-type: none"> Appears while driving - Immediately stop in a safe place.  If the Low Oil Level Symbol Appears P. 757
	<ul style="list-style-type: none"> Appears when the engine is running, there is a system problem in the engine oil level sensor. 	<ul style="list-style-type: none"> Have your vehicle checked by a dealer.
	<ul style="list-style-type: none"> Appears if there is a problem with the automatic lighting control system. 	<ul style="list-style-type: none"> Appears while driving - Manually turn the lights on, and have your vehicle checked by a dealer.
	<ul style="list-style-type: none"> Appears when there is a problem with the headlights. 	<ul style="list-style-type: none"> Appears while driving - The headlights may not be on. When conditions allow you to drive safely, have your vehicle checked by a dealer as soon as possible.
	<ul style="list-style-type: none"> Appears if there is a problem a problem with the e-pretensioner system. 	<ul style="list-style-type: none"> Have your vehicle checked by a dealer.

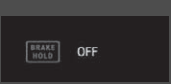



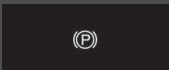
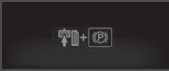

*1: Models with the keyless access system have an **ENGINE START/STOP** button instead of an ignition switch.

Message	Condition	Explanation
	<ul style="list-style-type: none"> Appears if there is a problem with the shutter grill, and the radiator coolant temperature is too high. 	<ul style="list-style-type: none"> Power output will be reduced, so you may not be able to accelerate or maintain your current speed. Have your vehicle checked by a dealer.
 (White)	<ul style="list-style-type: none"> Appears when the engine coolant temperature is near its upper limit. 	<ul style="list-style-type: none"> Drive slowly to prevent overheating.
 (Red)	<ul style="list-style-type: none"> Appears when the engine coolant temperature gets abnormally high. 	<p> Overheating P. 749</p>
 (White)	<ul style="list-style-type: none"> Appears when you turn the ignition switch to ON *1 without fastening the driver's seat belt. 	<ul style="list-style-type: none"> Fasten the seat belt properly before you start to drive.
	<p>Models with colour audio system</p> <ul style="list-style-type: none"> Appears while you are customizing the settings and the parking brake is released. 	<p> Customized Features P. 158</p>

*1: Models with the keyless access system have an **ENGINE START/STOP** button instead of an ignition switch.

Message	Condition	Explanation
<p>Continuously variable transmission models</p>  <p>Manual transmission models</p> 	<ul style="list-style-type: none"> Appears if the automatic brake hold is automatically cancelled while it is in operation. 	<ul style="list-style-type: none"> Immediately depress the brake pedal.
	<ul style="list-style-type: none"> Appears when the automatic brake hold system is turned off. 	<p>➤ Automatic Brake Hold P. 634</p>
	<ul style="list-style-type: none"> Appears when the automatic brake hold button is pressed without wearing the driver's seat belt. 	<ul style="list-style-type: none"> Fasten the driver's seat belt. <p>➤ Automatic Brake Hold P. 634</p>

Message	Condition	Explanation
<p>Continuously variable transmission models</p>  <p>Manual transmission models</p> 	<ul style="list-style-type: none"> • Appears when the automatic brake hold button is pressed without depressing the brake pedal while the automatic brake hold is in operation. 	<ul style="list-style-type: none"> • Press the automatic brake hold button with the brake pedal depressed. <ul style="list-style-type: none"> ► Automatic Brake Hold P. 634
	<ul style="list-style-type: none"> • Appears when the parking brake is applied automatically while it is in operation. 	<ul style="list-style-type: none"> ► Automatic Brake Hold P. 634 ► Parking Brake P. 629
<p>Continuously variable transmission models</p>  <p>Manual transmission models</p> 	<ul style="list-style-type: none"> • Appears when the electric parking brake switch is pressed without depressing the brake pedal while the electric parking brake is in operation. 	<ul style="list-style-type: none"> • Appears while driving - Press the electric parking brake switch with the brake pedal depressed. <ul style="list-style-type: none"> ► Parking Brake P. 629







Message	Condition	Explanation
 (White)  (Amber)	<ul style="list-style-type: none"> Appears if the vehicle is being driven in a manner consistent with drowsy or inattentive driving. 	<p>➤ Driver Attention Monitor P. 152</p>
 *2  *3	<ul style="list-style-type: none"> Appears when any of the second row and third row* seat belts are latched or unlatched, or either rear door is opened and closed. 	<p>➤ Seat Belt Reminder P. 45</p>
	<ul style="list-style-type: none"> Appears when the vehicle speed reaches the set speed. You can set two different speeds for the alarm. 	<p>➤ Speed Alarm P. 156</p>
	<ul style="list-style-type: none"> Appears when the starter system has a problem. 	<ul style="list-style-type: none"> As a temporary measure, hold the ignition switch to START *1 for up to 15 seconds while pressing the brake pedal and clutch pedal (manual transmission only), and manually start the engine. Have your vehicle checked by a dealer.

*1: Models with the keyless access system have an **ENGINE START/STOP** button instead of an ignition switch.

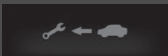
*2: Models without third row seat

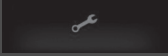
*3: Models with third row seat

Models with service reminder system

Message	Condition	Explanation
	<ul style="list-style-type: none"> Appears when any of the service items is required in less than 30 days. 	<ul style="list-style-type: none"> The remaining days will be counted down per day.  Service Reminder System * P. 662
	<ul style="list-style-type: none"> Appears when any of the service items is required in less than 10 days. 	<ul style="list-style-type: none"> Have the indicated service performed as soon as possible.  Service Reminder System * P. 662
	<ul style="list-style-type: none"> Appears when the indicated maintenance service is still not done after the remaining time reaches 0. 	<ul style="list-style-type: none"> Your vehicle has passed the service required point. Immediately have the service performed and make sure to reset the service reminder.  Service Reminder System * P. 662

* Not available on all models



Models with oil monitor system

Message	Condition	Explanation
	<ul style="list-style-type: none"> Appears when the scheduled maintenance is due soon. 	<ul style="list-style-type: none"> The engine oil, or the engine oil and oil filter should be changed soon. ➤ Oil Monitor System* P. 667
	<ul style="list-style-type: none"> Appears when the scheduled maintenance is due. 	<ul style="list-style-type: none"> The engine oil, or the engine oil and oil filter should be changed as soon as possible. ➤ Oil Monitor System* P. 667
	<ul style="list-style-type: none"> Appears when the scheduled engine oil change is passed due. 	<ul style="list-style-type: none"> The engine oil, or the engine oil and oil filter should be changed immediately. ➤ Oil Monitor System* P. 667

Models with headlight washer

Message	Condition	Explanation
	<ul style="list-style-type: none"> Appears when washer fluid gets low. 	<ul style="list-style-type: none"> Refill washer fluid. ➤ Refilling Window Washer Fluid P. 692

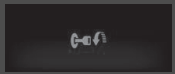

Models without keyless access system

Message	Condition	Explanation
	<ul style="list-style-type: none"> Appears when you open the driver's door while the ignition key is in ACCESSORY I. 	<ul style="list-style-type: none"> Turn the ignition switch to LOCK 0, then remove the key.
	<ul style="list-style-type: none"> Appears when you open the driver's door while the ignition key is in LOCK 0. 	<ul style="list-style-type: none"> Remove the key from the ignition switch.
	<ul style="list-style-type: none"> Appears when the ignition key is turned to ACCESSORY I from ON II. (The driver's door is closed.) 	—



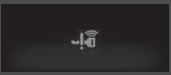
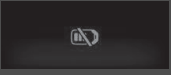

Models without keyless access system with manual transmission

Message	Condition	Explanation
	<ul style="list-style-type: none"> Appears when the ignition switch is turned to START III without depressing the clutch pedal. 	<ul style="list-style-type: none"> Turn the ignition switch with depressing the clutch pedal.





Models with keyless access system

Message	Condition	Explanation
	<ul style="list-style-type: none"> Appears as soon as a problem is detected in the keyless access system or keyless starting system. 	<ul style="list-style-type: none"> Appears constantly - Have your vehicle checked by a dealer.
	<ul style="list-style-type: none"> Appears when you close the door with the power mode on without the keyless remote inside the vehicle. 	<ul style="list-style-type: none"> The message goes away when you bring the keyless remote back inside the vehicle, and close the door. <ul style="list-style-type: none"> ➤ Keyless Remote Reminder P. 220
	<ul style="list-style-type: none"> Appears when the keyless remote battery becomes weak. 	<ul style="list-style-type: none"> Replace the battery as soon as possible. <ul style="list-style-type: none"> ➤ Replacing the Button Battery P. 718

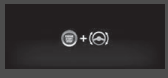

Models with keyless access system

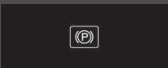
Message	Condition	Explanation
<p>Continuously variable transmission models</p>  <p>Manual transmission models</p> 	<ul style="list-style-type: none"> Appears after you set the power mode to ACCESSORY or ON. <p>Right-hand drive type</p> <ul style="list-style-type: none"> Appears after you unlock and open the driver's door. 	<p>➤ Starting the Engine P. 517</p>
	<ul style="list-style-type: none"> Appears when the power mode is ACCESSORY. Appears after the driver's door is opened when the power mode is ACCESSORY. 	<p>—</p> <ul style="list-style-type: none"> Press the ENGINE START/STOP button twice with your foot off the brake pedal (automatic transmission) or the clutch pedal (manual transmission) to change the power mode to VEHICLE OFF (LOCK).
	<ul style="list-style-type: none"> Appears if the keyless remote's battery is too weak to start the engine or the key is not within operating range to start the engine. The beeper sounds six times. 	<ul style="list-style-type: none"> Bring the keyless remote in front of the ENGINE START/STOP button to be touched with. <p>➤ If the Keyless Remote Battery is Weak P. 744</p>

Models with keyless access system



Message	Condition	Explanation
	<ul style="list-style-type: none"> Appears when the steering wheel is locked. 	<ul style="list-style-type: none"> Move the steering wheel left and right while pressing the ENGINE START/STOP button.
<p>Continuously variable transmission models</p>  <p>(Amber)</p>	<ul style="list-style-type: none"> Appears if you push the ENGINE START/STOP button to turn the engine off without the shift lever in P. 	<ul style="list-style-type: none"> Move the shift lever to P, then press the ENGINE START/STOP button twice.
<p>Continuously variable transmission models</p>  <p>(White)</p>	<ul style="list-style-type: none"> Appears if you press the ENGINE START/STOP button and the parking brake is not activated or the shift lever is in N position. 	<ul style="list-style-type: none"> Move the shift lever to P position and start the engine.
 <p>(White)</p>	<ul style="list-style-type: none"> Appears when the parking brake is disengaged while the power mode is in ON. 	<ul style="list-style-type: none"> Set the parking brake, then start the engine in the normal procedure. <ul style="list-style-type: none"> ➤ Parking Brake P. 629 ➤ Starting the Engine P. 517
	<ul style="list-style-type: none"> Appears if you press the ENGINE START/STOP button while the vehicle is moving. 	<ul style="list-style-type: none"> ➤ Emergency Engine Stop P. 745

Models with auto idle stop

Message	Condition	Explanation
	<ul style="list-style-type: none"> Appears when the engine does not restart automatically due to the following reasons: <ul style="list-style-type: none"> The bonnet is open. There is a problem in the system that disables Auto Idle Stop. 	<ul style="list-style-type: none"> Follow the normal procedure to start the engine. <ul style="list-style-type: none"> ► Starting the Engine P. 514, 517
	<ul style="list-style-type: none"> Appears when you move the shift lever from N to any other position without depressing the clutch pedal while Auto Idle Stop is in operation. 	<ul style="list-style-type: none"> The engine will not start even when the battery charge becomes low. Shift to N to avoid the battery charge becomes low. <ul style="list-style-type: none"> ► Auto Idle Stop P. 532
	<ul style="list-style-type: none"> Appears in white when you turn the ignition switch to START III^{*1} before fully depressing the clutch pedal. 	<ul style="list-style-type: none"> Depress the clutch pedal.
	<ul style="list-style-type: none"> Appears in amber when the following conditions are kept while Auto Idle Stop is in operation: <ul style="list-style-type: none"> You are not wearing a seat belt. The shift lever is in any position except N. 	<ul style="list-style-type: none"> Depress the clutch pedal. Wear the seat belt immediately, and continue to keep the shift lever in N next time Auto Idle Stop activates.





*1: Models with the keyless access system have an **ENGINE START/STOP** button instead of an ignition switch.

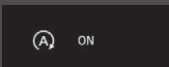
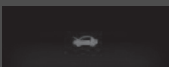

Models with auto idle stop

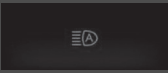

Message	Condition	Explanation
	<ul style="list-style-type: none"> • Appears when Auto Idle Stop does not activate for some reason. • Appears when the engine restarts automatically. • Appears when the battery temperature is around 5°C or lower. 	<p>➤ Auto Idle Stop Activates When: P. 534</p>
	<ul style="list-style-type: none"> • Appears when Auto Idle Stop does not activate because the engine coolant temperature is low or high. 	<p>➤ Auto Idle Stop does not activate when: P. 534</p>
	<ul style="list-style-type: none"> • Appears when Auto Idle Stop does not activate because the climate control system is in use, and the difference between the set temperature and actual interior temperature becomes significant. • Appears when the system is under the following conditions while Auto Idle Stop activates: <ul style="list-style-type: none"> - The climate control system is in use, and the difference between the set temperature and actual interior temperature becomes significant. - The humidity in the interior is high. 	<p>➤ Auto Idle Stop Activates When: P. 534</p> <ul style="list-style-type: none"> • The engine restarts automatically in a few seconds.



Models with auto idle stop

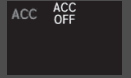

Message	Condition	Explanation
	<ul style="list-style-type: none"> • Appears when Auto Idle Stop does not activate because the battery charge level is low. • Appears when the battery is low performance. 	<p>➔ Auto Idle Stop P. 532</p>
	<ul style="list-style-type: none"> • Appears when you turn the Auto Idle Stop system on. 	<p>➔ Auto Idle Stop P. 532</p>
	<ul style="list-style-type: none"> • Appears when the bonnet is opened. 	<ul style="list-style-type: none"> • Close the bonnet.





Message	Condition	Explanation
	<ul style="list-style-type: none"> Appears if there is a problem with the auto high-beam. 	<ul style="list-style-type: none"> Manually operate the headlight switch. If you are driving with the high beam headlights when this happens, the headlights are changed to low beams.
	<ul style="list-style-type: none"> Appears if anything covers the radar sensor cover and prevents the sensor from detecting a vehicle in front. May appear when driving in bad weather (rain, snow, fog, etc.) 	<ul style="list-style-type: none"> When the radar sensor gets dirty, stop your vehicle in a safe place, and wipe off dirt using a soft cloth. Have your vehicle checked by a dealer if the message does not disappear even after you clean the sensor cover. <ul style="list-style-type: none"> ➤ Radar Sensor P. 628 ➤ Honda Sensing P. 558
	<ul style="list-style-type: none"> Appears if the temperature inside the front sensor camera is too high and some driver assist systems cannot be activated. 	<ul style="list-style-type: none"> Use the climate control system to cool down the camera. Disappears - The camera has been cooled down and the systems are activated normally. <ul style="list-style-type: none"> ➤ Front Sensor Camera P. 626 ➤ Honda Sensing P. 558
	<ul style="list-style-type: none"> Appears if the area around the front sensor camera is blocked by dirt, mud, etc. and be prevented from detecting a vehicle in front. May appear when driving in bad weather (rain, snow, fog, etc.) 	<ul style="list-style-type: none"> When the front window gets dirty, stop your vehicle in a safe place, and wipe it off with a soft cloth. Have your vehicle checked by a dealer if the message does not disappear even after you cleaned the area around the camera. <ul style="list-style-type: none"> ➤ Front Sensor Camera P. 626 ➤ Honda Sensing P. 558



Message	Condition	Explanation
	<ul style="list-style-type: none"> Appears when the system predicts the vehicle cutting in in front of you from the right and decrease your vehicle speed according to the cut-in vehicle. 	<ul style="list-style-type: none"> The system automatically keeps a safe distance from the cut-in vehicle when the system predicts the cutting in. <ul style="list-style-type: none"> ➤ How the system activates P. 588, 603
	<ul style="list-style-type: none"> Appears when the system predicts the vehicle cutting in in front of you from the left and decrease your vehicle speed according to the cut-in vehicle. 	<ul style="list-style-type: none"> The system automatically keeps a safe distance from the cut-in vehicle when the system predicts the cutting in. <ul style="list-style-type: none"> ➤ How the system activates P. 588, 603
	<ul style="list-style-type: none"> Appears when ACC has been automatically cancelled. 	<ul style="list-style-type: none"> You can resume the set speed after the condition that caused ACC to cancel improves. Press the RES/+ button. <ul style="list-style-type: none"> ➤ Adaptive Cruise Control (ACC) with Low Speed Follow (LSF) P. 572 ➤ Adaptive Cruise Control (ACC) P. 589



Message	Condition	Explanation
	<ul style="list-style-type: none"> Appears when the distance between your vehicle and the vehicle ahead of you is too close while ACC is in operation. 	<ul style="list-style-type: none"> ACC has been automatically cancelled. <ul style="list-style-type: none"> ➤ Adaptive Cruise Control (ACC) with Low Speed Follow (LSF) P. 572 ➤ Adaptive Cruise Control (ACC) P. 589
	<ul style="list-style-type: none"> Appears when pressing the -/SET button while the distance between your vehicle and the vehicle ahead of you is too close. 	<ul style="list-style-type: none"> ACC cannot be set. <ul style="list-style-type: none"> ➤ Adaptive Cruise Control (ACC) with Low Speed Follow (LSF) P. 572 ➤ Adaptive Cruise Control (ACC) P. 589
Continuously variable transmission models  (White)	<ul style="list-style-type: none"> Appears when the driver's seat belt is unfastened while your vehicle is automatically stopped by ACC. Appears when pressing the -/SET button while the driver's seat belt is unfastened. 	<ul style="list-style-type: none"> ACC has been automatically cancelled. <ul style="list-style-type: none"> ➤ Adaptive Cruise Control (ACC) with Low Speed Follow (LSF) P. 572 ACC cannot be set. <ul style="list-style-type: none"> ➤ Adaptive Cruise Control (ACC) with Low Speed Follow (LSF) P. 572

Message	Condition	Explanation
	<ul style="list-style-type: none"> Appears if the VSA or traction control function operates while ACC is in operation. 	<ul style="list-style-type: none"> ACC has been automatically cancelled. <ul style="list-style-type: none"> ➤ Adaptive Cruise Control (ACC) with Low Speed Follow (LSF) P. 572 ➤ Adaptive Cruise Control (ACC) P. 589
Manual transmission models 	<ul style="list-style-type: none"> Appears when pressing the RES/+ or -/SET button while the vehicle is moving and the brake pedal is depressed. 	<ul style="list-style-type: none"> ACC cannot be set. <ul style="list-style-type: none"> ➤ Adaptive Cruise Control (ACC) P. 589
Manual transmission models 	<ul style="list-style-type: none"> Appears when pressing the RES/+ or -/SET button while the vehicle is moving and the clutch pedal is depressed. Appears when the clutch pedal is applied too long while ACC is in operation. 	<ul style="list-style-type: none"> ACC cannot be set. <ul style="list-style-type: none"> ➤ Adaptive Cruise Control (ACC) P. 589 ACC has been automatically cancelled. <ul style="list-style-type: none"> ➤ Adaptive Cruise Control (ACC) P. 589

Message	Condition	Explanation
	<ul style="list-style-type: none"> Appears when the speed of the vehicle is too high for you to set ACC. 	<ul style="list-style-type: none"> Reduce the speed, then set ACC. <ul style="list-style-type: none"> ➤ Adaptive Cruise Control (ACC) with Low Speed Follow (LSF) P. 572 ➤ Adaptive Cruise Control (ACC) P. 589
	<ul style="list-style-type: none"> Appears when ACC is cancelled due to excessive high vehicle speed. 	<ul style="list-style-type: none"> Reduce the speed, then reset ACC. <ul style="list-style-type: none"> ➤ Adaptive Cruise Control (ACC) with Low Speed Follow (LSF) P. 572 ➤ Adaptive Cruise Control (ACC) P. 589
	<p>Manual transmission models</p> <ul style="list-style-type: none"> Appears when the speed of the vehicle is too low for you to set ACC. 	<ul style="list-style-type: none"> Raise the speed, then set ACC. <ul style="list-style-type: none"> ➤ Adaptive Cruise Control (ACC) P. 589
	<p>Manual transmission models</p> <ul style="list-style-type: none"> Appears when ACC is cancelled due to excessive low vehicle speed. 	<ul style="list-style-type: none"> Raise the speed, then reset ACC. <ul style="list-style-type: none"> ➤ Adaptive Cruise Control (ACC) P. 589
<p>Continuously variable transmission models</p> 	<ul style="list-style-type: none"> Appears when the vehicle ahead of you resumes driving, after your vehicle has been stopped automatically by ACC. 	<ul style="list-style-type: none"> Press the RES/+ or -/SET button or depress the accelerator pedal to resume. <ul style="list-style-type: none"> ➤ Adaptive Cruise Control (ACC) with Low Speed Follow (LSF) P. 572

Message	Condition	Explanation
Continuously variable transmission models	<ul style="list-style-type: none"> Appears when the shift lever is moved into any position other than D or S while ACC is in operation. 	<ul style="list-style-type: none"> ACC has been automatically cancelled. <ul style="list-style-type: none"> ➤ Adaptive Cruise Control (ACC) with Low Speed Follow (LSF) P. 572
	<ul style="list-style-type: none"> Appears when pressing the -/SET button while the shift lever is in any position other than D or S. 	<ul style="list-style-type: none"> ACC cannot be set. <ul style="list-style-type: none"> ➤ Adaptive Cruise Control (ACC) with Low Speed Follow (LSF) P. 572
Continuously variable transmission models	<ul style="list-style-type: none"> Appears when the vehicle is stopped on a very steep slope while ACC is in operation. 	<ul style="list-style-type: none"> ACC has been automatically cancelled. <ul style="list-style-type: none"> ➤ Adaptive Cruise Control (ACC) with Low Speed Follow (LSF) P. 572
	<ul style="list-style-type: none"> Appears when pressing the -/SET button while the vehicle is stopped on a very steep slope. 	<ul style="list-style-type: none"> ACC cannot be set. <ul style="list-style-type: none"> ➤ Adaptive Cruise Control (ACC) with Low Speed Follow (LSF) P. 572
		
Continuously variable transmission models	<ul style="list-style-type: none"> Appears when the parking brake is applied automatically while ACC is in operation. 	<ul style="list-style-type: none"> ACC has been automatically cancelled. <ul style="list-style-type: none"> ➤ Adaptive Cruise Control (ACC) with Low Speed Follow (LSF) P. 572 ➤ Parking Brake P. 629
	<ul style="list-style-type: none"> Appears when pressing the -/SET button while the parking brake is applied. 	<ul style="list-style-type: none"> ACC cannot be set. <ul style="list-style-type: none"> ➤ Adaptive Cruise Control (ACC) with Low Speed Follow (LSF) P. 572 ➤ Parking Brake P. 629

Message	Condition	Explanation
<p>Continuously variable transmission models</p> 	<ul style="list-style-type: none"> Appears when pressing the –/SET button while the vehicle is moving and the brake pedal is depressed. 	<ul style="list-style-type: none"> ACC cannot be set. <ul style="list-style-type: none"> ➤ Adaptive Cruise Control (ACC) with Low Speed Follow (LSF) P. 572
<p>Continuously variable transmission models</p> 	<ul style="list-style-type: none"> Appears if ACC is cancelled while your vehicle is automatically stopped by ACC. 	<ul style="list-style-type: none"> Immediately depress the brake pedal.
	<ul style="list-style-type: none"> Flashes when the system senses a likely collision with a vehicle in front of you. The beeper sounds. 	<ul style="list-style-type: none"> Take appropriate action to prevent a collision (apply the brakes, change lanes, etc.) <ul style="list-style-type: none"> ➤ Adaptive Cruise Control (ACC) with Low Speed Follow (LSF) P. 572 ➤ Adaptive Cruise Control (ACC) P. 589 ➤ Collision Mitigation Braking System (CMBS) P. 561



Message	Condition	Explanation
 (Amber)	<ul style="list-style-type: none"> Appears if the vehicle is about to veer out of the detected lane. 	<ul style="list-style-type: none"> Take direct control of the steering and keep the vehicle in the centre of the lane. The message will disappear after a while. <ul style="list-style-type: none"> ➤ Lane Keeping Assist System (LKAS) P. 604 ➤ Road Departure Mitigation System P. 612
 (Red)	<ul style="list-style-type: none"> Appears if the driver is merely resting his or her hands on the steering wheel or is not holding the steering wheel at all and the vehicle is about to veer out of the detected lane. A beeper will also sound. Blinks if the driver is merely resting his or her hands on the steering wheel or is not holding the steering wheel at all. A beeper will also sound. If the driver continues to drive in this manner, the beeper will turn to a single long beep and LKAS will be deactivated. 	<ul style="list-style-type: none"> Take direct control of the steering and keep the vehicle in the centre of the lane. The message will disappear after a while. <ul style="list-style-type: none"> ➤ Lane Keeping Assist System (LKAS) P. 604 Take direct control of the steering; the message will disappear. <ul style="list-style-type: none"> ➤ Lane Keeping Assist System (LKAS) P. 604
 (White)	<ul style="list-style-type: none"> Appears when the vehicle is likely to drive out of a detected lane. The Road Departure Mitigation system also steers the vehicle to help you remain within your driving lane. 	<ul style="list-style-type: none"> Take direct control of the steering and keep the vehicle in the centre of the lane. The message will disappear after a while. <ul style="list-style-type: none"> ➤ Road Departure Mitigation System P. 612

Message	Condition	Explanation
	<ul style="list-style-type: none"> Appears when the LKAS is in operation, or the LKAS button is pressed, but there is a problem with a system related to the LKAS. The LKAS cancels automatically. The beeper sounds simultaneously if selected by customization. 	<ul style="list-style-type: none"> If any other system indicators come on, such as the VSA, ABS and brake system, take appropriate action. <ul style="list-style-type: none"> ► Indicators P. 98

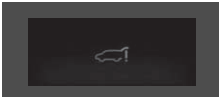
Models with power tailgate

Message	Condition	Explanation
	<ul style="list-style-type: none"> Appears when there is a problem with the power tailgate system. 	<ul style="list-style-type: none"> Manually open or close the power tailgate. Have your vehicle checked by a dealer.

Models with real time AWD with intelligent control system

Message	Condition	Explanation
	<ul style="list-style-type: none"> Appears if there is a problem with the real time AWD with intelligent control system. 	<ul style="list-style-type: none"> The engine drives the front wheels only in this state. Have your vehicle checked by a dealer.
	<ul style="list-style-type: none"> Appears when the differential temperature is too high. 	<ul style="list-style-type: none"> Stop in a safe place, change to [P], and idle the engine until the message disappears. If the message does not disappear, have your vehicle checked by a dealer. <ul style="list-style-type: none"> ► Real Time AWD with Intelligent Control System* P. 550

Gauges

Gauges include the speedometer, tachometer, fuel gauge, and related indicators. They are displayed when the ignition switch is in ON *1.

Speedometer

Displays your driving speed in km/h or mph.

Tachometer

Shows the number of engine revolutions per minute.

Fuel Gauge



Displays the amount of fuel left in the fuel tank.

Temperature Gauge

Displays the temperature of the engine coolant.

* 1: Models with the keyless access system have an **ENGINE START/STOP** button instead of an ignition switch.

Speedometer

Press the  (display/information) button repeatedly until the  icon is shown on the driver information interface. Press **ENTER**, then press and hold it again. The speedometer reading and the displayed measurements will switch between km/h and mph.

Fuel Gauge

NOTICE

You should refuel when the reading approaches . Running out of fuel can cause the engine to misfire, damaging the catalytic converter.

The actual amount of remaining fuel may differ from the fuel gauge reading.

Temperature Gauge

NOTICE

Driving with the temperature gauge pointer in the upper zone can cause serious engine damage. Pull safely to the side of the road and allow engine temperature to return to normal.

 **Overheating** P. 749



Driver Information Interface

The driver information interface shows the odometer, trip meter, outside temperature indicator, and other gauges.

It also displays important messages such as warnings and other helpful information.

Switching the Display

Main displays

Press the  (display/information) button, and then press  or  to change the display. Press **ENTER** to see detailed information.

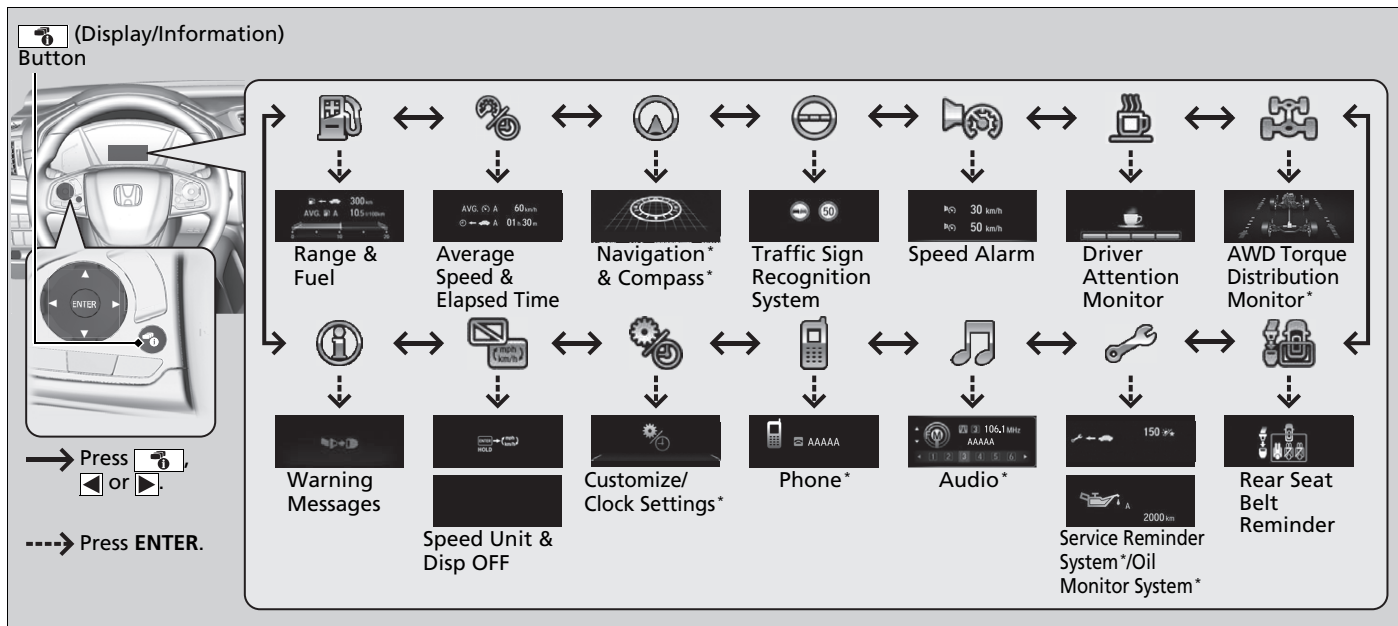

■ Trip computer

Press the  (TRIP) knob to change display.

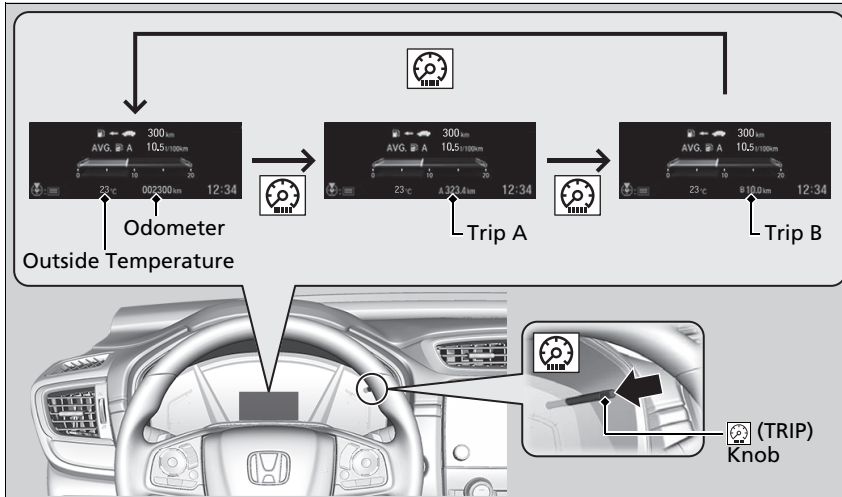

■ Odometer

Shows the total number of kilometres or miles that your vehicle has accumulated.

■ Trip Meter

Shows the total number of kilometres or miles driven since the last reset. Meters A and B can be used to measure two separate trips.

■ Resetting a trip meter

To reset a trip meter, display it, then press and hold the  knob. The trip meter is reset to **0.0**.

■ Average Fuel Economy

Shows the estimated average fuel economy of each trip meter in l/100 km or mpg. The display is updated at set intervals. When a trip meter is reset, the average fuel economy is also reset.

■ Range

Shows the estimated distance you can travel on the remaining fuel. This distance is estimated from the fuel economy of your previous trips.

■ Elapsed Time

Shows the time elapsed since the last time Trip A or Trip B was reset.

■ Average Speed

Shows the average speed in km/h or mph since the last time Trip A or Trip B was reset.

» Trip Meter

Switch between trip meter A and trip meter B by pressing the  knob.

» Average Fuel Economy

You can change when to reset the average fuel economy.

➤ **Customized Features** P. 158, 413

» Elapsed Time

You can change when to reset the elapsed time.

➤ **Customized Features** P. 158, 413

» Average Speed

You can change when to reset the average speed.

➤ **Customized Features** P. 158, 413

■ Instant Fuel Economy Gauge

Shows the instant fuel economy as a bar graph in l/100 km or mpg.

■ Service Reminder System *

Shows the service reminder system.

🔍 **Service Reminder System** * P. 662

■ Oil Monitor System *

Show the oil monitor system.

🔍 **Oil Monitor System** * P. 667

■ Rear Seat Belt Reminder

Appears when any of the rear seat belts are latched or unlatched.

■ Outside Temperature

Shows the outside temperature in Celsius.

If the outside temperature has been below 3°C at the time you turn the ignition switch to ON ^{*1}, the outside temperature indicator blinks for ten seconds.

■ Adjusting the outside temperature display

Adjust the temperature reading up to ±3°C if the temperature reading seems incorrect.

*1: Models with the keyless access system have an **ENGINE START/STOP** button instead of an ignition switch.

* Not available on all models

🔍 Outside Temperature

The temperature sensor is in the front bumper. Road heat and exhaust from another vehicle can affect the temperature reading when your vehicle speed is less than 30 km/h (19 mph).

It may take several minutes for the display to be updated after the temperature reading has stabilized.

Use the driver information interface or audio/information screen's customized features to correct the temperature.

🔍 **Customized Features** P. 158, 413

Continued

■ Driver Attention Monitor

The Driver Attention Monitor analyses steering inputs to determine if the vehicle is being driven in a manner consistent with drowsy or inattentive driving. If it determines that the vehicle is being driven in such a manner, it will display the degree of the driver's attention in the Driver Information Interface.

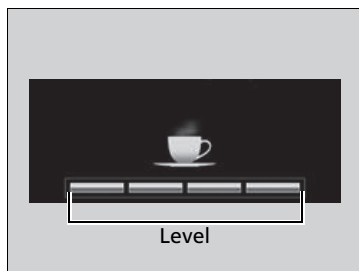
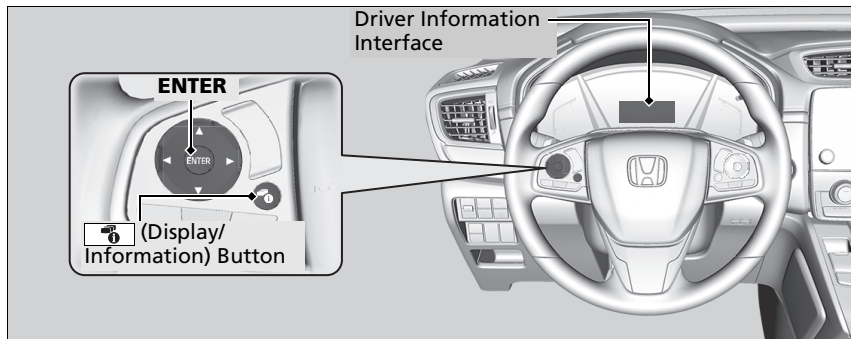

When the  (display/information) button is pressed, bars in the Driver Information Interface light up in white to indicate the degree of the driver's attention.

➤ **Switching the Display** P. 148

▶▶ Driver Attention Monitor

The Driver Attention Monitor cannot always detect if the driver is tired or inattentive. Regardless of the system's feedback, if you are feeling tired, stop in a safe location and rest for as long as needed.



If the number of bars drops to two, the Driver Attention Monitor will display the white coffee cup (without the bars) to warn the driver that his or her attention level is low.

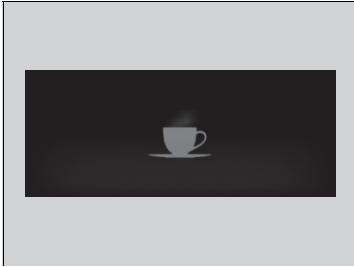

If the number of bars drops to one, a beep will sound, the steering wheel will vibrate, and the coffee cup will turn to amber to warn the driver that he or she needs a break as his or her attention level is too low.

If the coffee cup lights up in amber, stop in a safe location and rest for as long as needed. The amber coffee cup warning will disappear when the **ENTER** button is pressed or when the system has determined that the driver is driving normally.

If the driver does not take a break and the monitor continues to detect that the driver is very tired, the coffee cup will light up in amber again after approximately 15 minutes, accompanied by a beep and steering wheel vibrations.

The warnings do not appear when the travelling time is 30 minutes or less.

■ The Driver Attention Monitor resets when

- the engine is turned off.
- the driver unfastens the seat belt and opens the door while the vehicle is stopped.

■ For the Driver Attention Monitor to function

- the vehicle must be travelling above 40 km/h (25 mph).
- the electric power steering (EPS) system indicator must be off.

■ Depending on driving conditions or other factors, the Driver Attention Monitor may not function in the following circumstances.

- the steering assist function of the Lane Keeping Assist System (LKAS) is active.
 - **Lane Keeping Assist System (LKAS)** P. 604
- the condition of the road is poor, e.g. the surface is unpaved or bumpy.
- it is windy.
- the driver is frequently operating the vehicle in an assertive manner such as changing lanes or accelerating.

■ Customizing

You can change the Driver Attention Monitor settings. Select **Tactile And Audible Alert**, **Tactile Alert Only/Tactile Alert**, or **OFF/Off**.

- **Customized Features** P. 158, 413

☒ For the Driver Attention Monitor to function

The bars in the Driver Information Interface remain grayed out unless the Driver Attention Monitor is functioning.

■ AWD Torque Distribution Monitor*

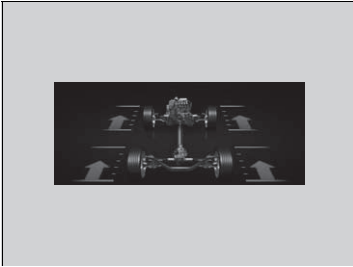

The indicators on the display show the amount of torque being transferred to the right front, left front, right rear, and left rear wheels.

■ **Real Time AWD with Intelligent Control System*** P. 550

■ Speed Alarm

Sets the speed alarm on and changes the speed alarm setting.

Each time you press the  button, the speed alarm setting changes as follows:

Instrument Panel

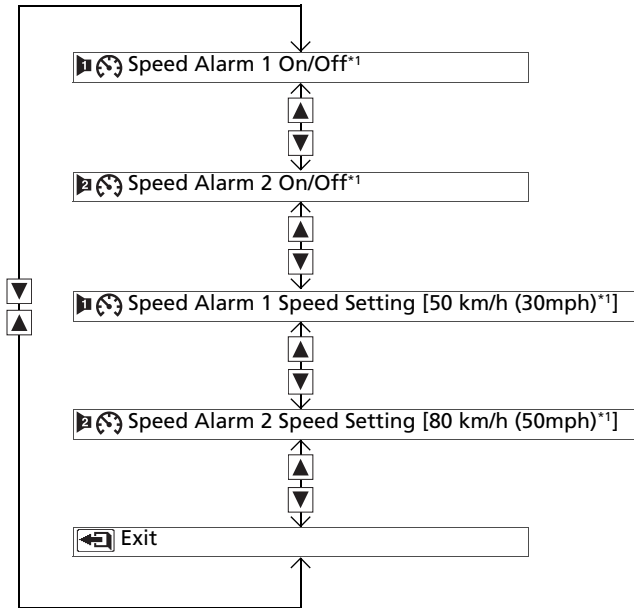

*1:Default Setting

■ Turn-by-Turn Directions *

Shows you turn-by-turn driving directions to your destination linked with the navigation system.

➤ **Refer to the Navigation System Manual**

■ Traffic Sign Recognition System

Shows the traffic sign recognition system.

➤ **Traffic Sign Recognition System** P. 618

■ Audio *

Shows the current audio information.

➤ **Audio System Basic Operation** P. 332

■ Phone *

Shows the current phone information.

➤ **Hands-Free Telephone System** P. 462

☒ Turn-by-Turn Directions *

The driver information interface shows a compass when the route guidance is not used.

You can select whether the turn-by-turn display comes on or not during the route guidance.





➤ **Customized Features** P. 158, 413

Models with colour audio system

■ Customized Features

Use the driver information interface to customize certain features.

■ How to customize

Select the  (Customize Settings) screen by pressing the  button while the ignition switch is in ON , and the vehicle is at a complete stop, and the parking brake is set. Select , then press the **ENTER** button.

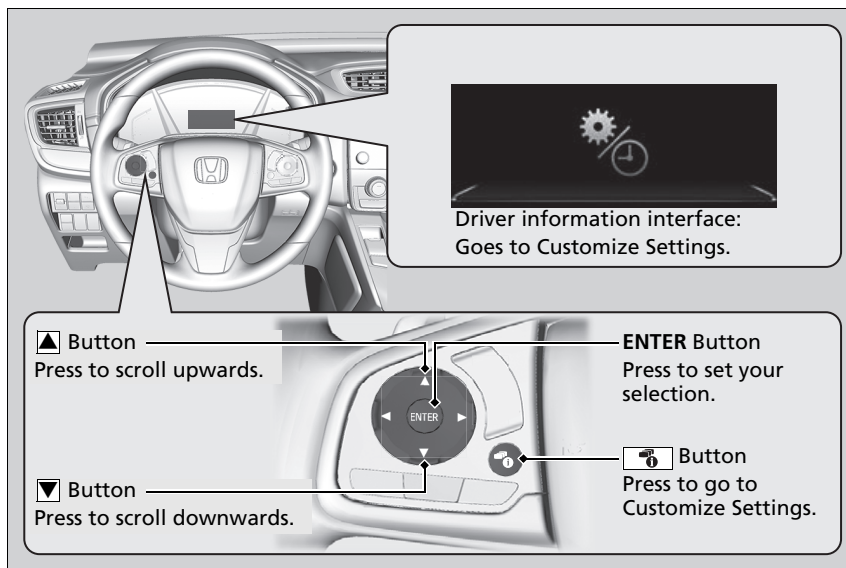

▶▶ Customized Features

To customize other features, press the  button.

▶ **List of customizable options** P. 162

▶ **Example of customization settings** P. 168

When you customize settings, set the parking brake.

■ **Customization flow**

Press the  button.

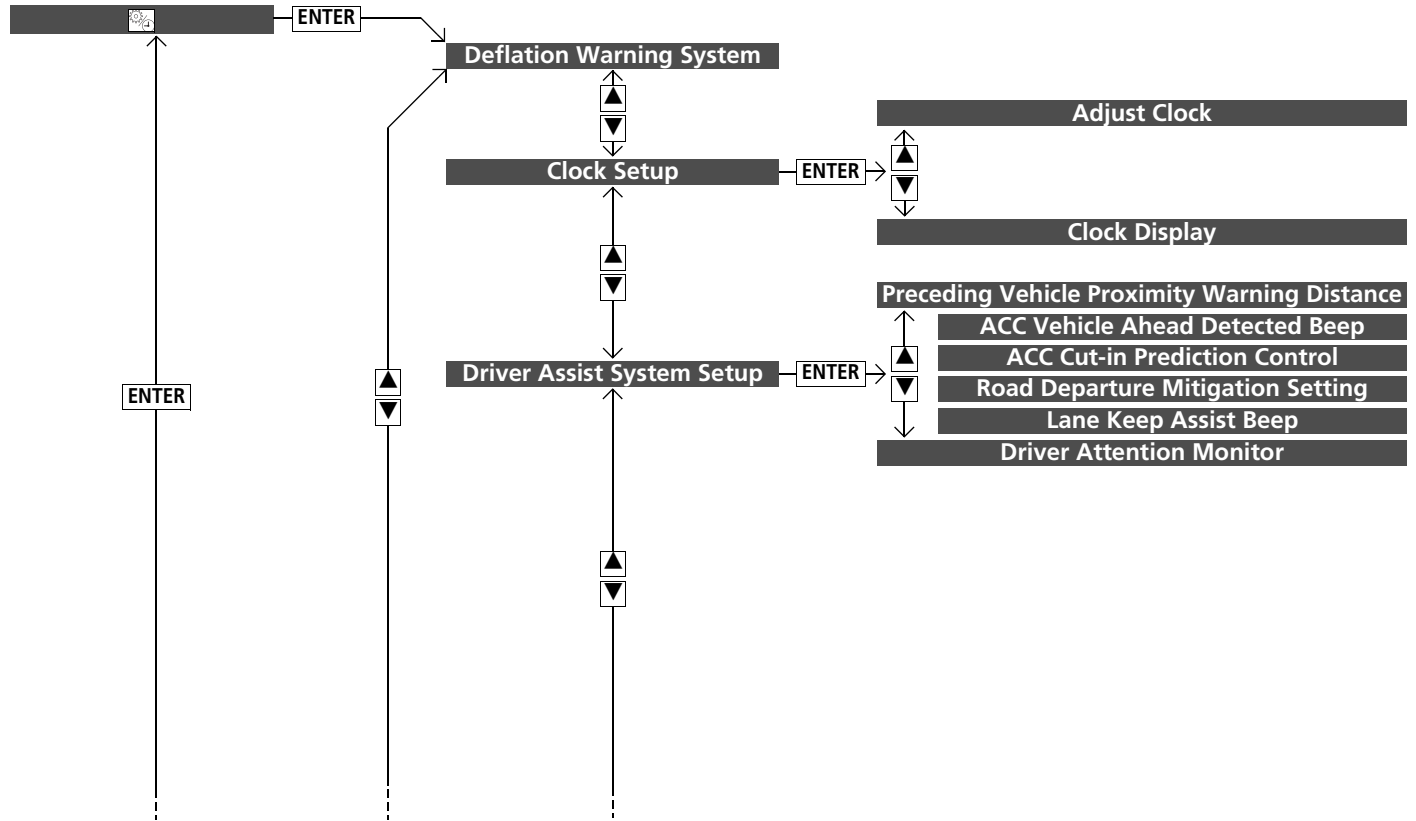

Instrument Panel

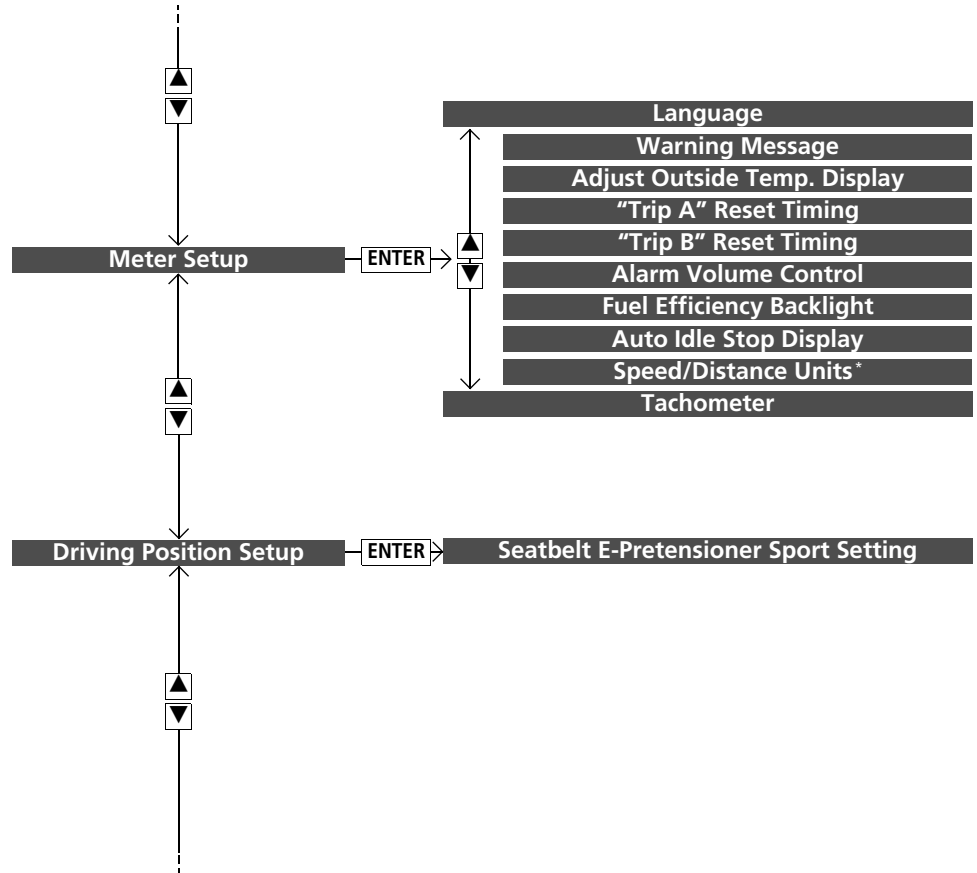

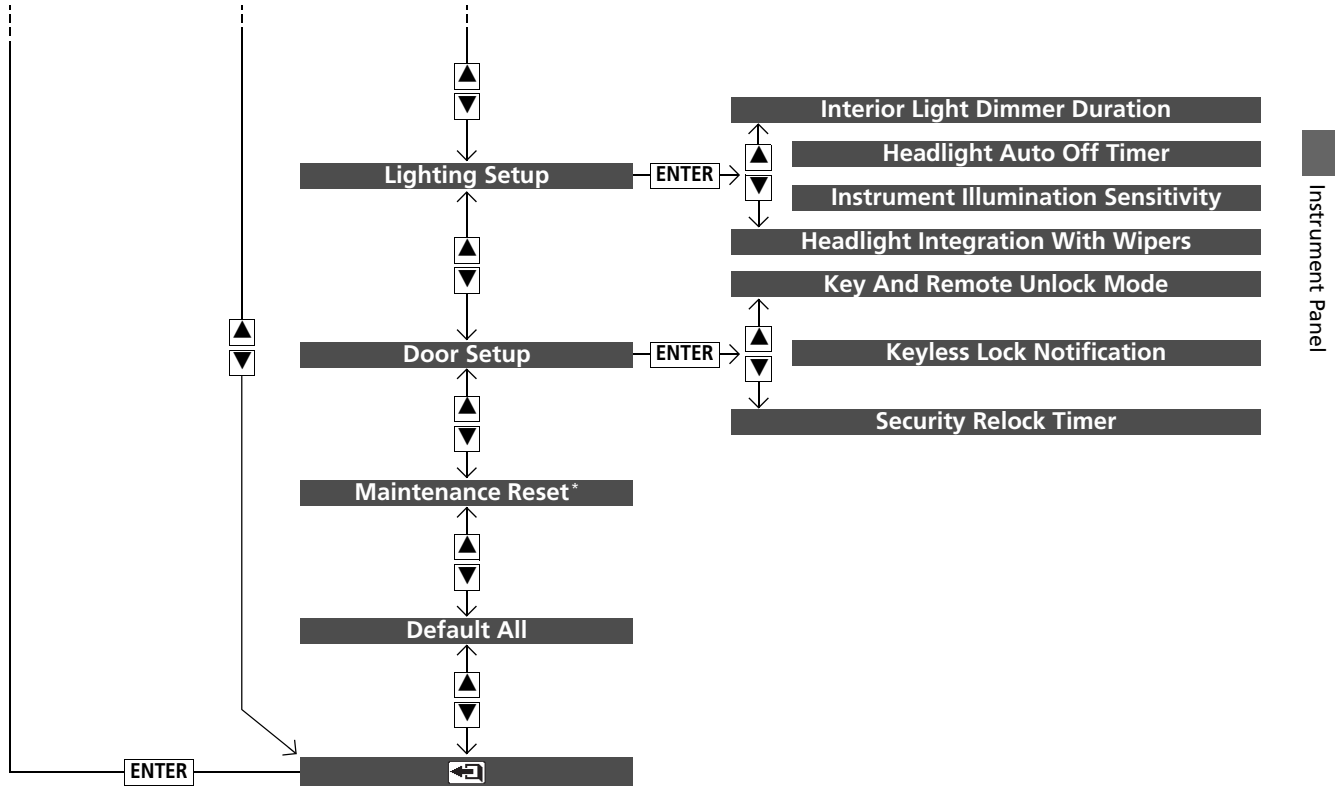

* Not available on all models

■ List of customizable options

Setup Group	Customizable Features	Description	Selectable Settings
Deflation Warning System	—	Initialises the deflation warning system.	Initialise/Cancel
Clock Setup	Adjust Clock	Adjust the time. <input checked="" type="checkbox"/> Adjusting the Clock P. 176	—
	Clock Display	Sets time display 24 hour, 12 hour or off.	24h/12h*1/OFF

*1:Default Setting

Setup Group	Customizable Features	Description	Selectable Settings
Driver Assist System Setup	Preceding Vehicle Proximity Warning Distance	Changes the distance at which CMBS alerts.	Far/Normal*¹/Near
	ACC Vehicle Ahead Detected Beep	Causes the system to beep when the system detects a vehicle, or when the vehicle goes out of ACC range.	ON/OFF*¹
	ACC Cut-in Prediction Control	Turns the ACC cut-in prediction control feature on and off.	ON*¹/OFF
	Road Departure Mitigation Setting	Changes the setting for the road departure mitigation system.	Normal*¹/Delayed/Warning Only/Early
	Lane Keep Assist Beep	Causes the system to beep when the LKAS is suspended.	ON/OFF*¹
	Driver Attention Monitor	Changes the setting for the driver attention monitor.	Tactile And Audible Alert*¹/Tactile Alert Only/OFF

*1:Default Setting

Setup Group	Customizable Features	Description	Selectable Settings
Meter Setup	Language	Changes the displayed language.	English*¹/French/Spanish/ German/Italian/ Portuguese/Russian/ Finnish/Norwegian/ Swedish/Danish/Dutch/ Polish/Turkish
	Warning Message	Switches warning message to be displayed or not.	ON/OFF*¹
	Adjust Outside Temp. Display	Adjusts the temperature reading by a few degrees.	-3°C ~ ±0°C*¹ ~ +3°C
	“Trip A” Reset Timing	Changes the setting of how to reset trip meter A, average fuel economy A, average speed A, and elapsed time A.	When Fully Refueled/ When Ignition Is Turned Off/Manual Reset*¹
	“Trip B” Reset Timing	Changes the setting of how to reset trip meter B, average fuel economy B, average speed B, and elapsed time B.	When Fully Refueled/ When Ignition Is Turned Off/Manual Reset*¹

*1:Default Setting

Setup Group	Customizable Features	Description	Selectable Settings
Meter Setup	Alarm Volume Control	Changes the alarm volume, such as buzzers, warnings, turn signal sound, and so on.	Max/Mid^{*1}/Min
	Fuel Efficiency Backlight	Turns the ambient meter feature on and off.	ON^{*1}/OFF
	Auto Idle Stop Display	Selects whether the Auto Idle Stop display comes on or not.	ON^{*1}/OFF
	Speed/Distance Units	Selects the trip computer units.	<div style="border: 1px solid black; padding: 2px;">Left-hand drive type</div> mph·miles/km/h·km^{*1} <div style="border: 1px solid black; padding: 2px;">Right-hand drive type</div> mph·miles^{*1}/km/h·km
	Tachometer	Selects whether the tachometer is displayed on the driver information interface.	ON^{*1}/OFF
Driving Position Setup	Seatbelt E-Pretensioner Sport Setting	Turns the auto seat belt tension setting for the seat belt e-pretensioner on and off.	ON^{*1}/OFF

*1:Default Setting

Setup Group	Customizable Features	Description	Selectable Settings
Lighting Setup	Interior Light Dimmer Duration	Changes the length of time the interior lights stay on after you close the doors.	60sec/30sec^{*1}/15sec
	Headlight Auto Off Timer	Changes the length of time the exterior lights stay on after you close the driver's door.	60sec/30sec/15sec^{*1}/0sec
	Instrument Illumination Sensitivity	Changes the sensitivity of the brightness of the instrument panel when the headlight switch is in the AUTO position.	Max/High/Mid^{*1}/Low/Min
	Headlight Integration With Wipers	Changes the settings for the wiper operation when the headlights automatically come on while the headlight switch is in the AUTO position.	ON^{*1}/OFF

*1:Default Setting

Setup Group	Customizable Features	Description	Selectable Settings
Door Setup	Key And Remote Unlock Mode	Sets up either the driver’s door or all doors to unlock on the first operation of the remote or ignition key.	Driver Door Only*1/All Doors
	Keyless Lock Notification	LOCK/UNLOCK- The exterior lights flash. LOCK (2nd push)- The beeper sounds.	ON*1/OFF
	Security Relock Timer	Changes the time it takes for the doors to relock and the security system to set after you unlock the vehicle without opening any door.	90sec/60sec/30sec*1
Maintenance Reset*	—	Cancels/Resets the service reminder display*/oil monitor display* when you have performed the maintenance service.	<div style="background-color: #333; color: white; padding: 2px;">Models with service reminder system</div> Cancel/All Due Items/Item A Only/Item B Only/Item 0 Only/Item 1 Only/Item 2 Only/Item 3 Only/Item 4 Only/Item 5 Only/Item 6 Only/Item 7 Only/Item 8 Only/Item 9 Only <div style="background-color: #333; color: white; padding: 2px;">Models with oil monitor system</div> Cancel/Reset
Default All	—	Cancels/Resets all the customized settings as default.	OK/Cancel

*1:Default Setting

* Not available on all models

■ Example of customization settings

The steps for changing the “Trip A” Reset Timing setting to **When Fully Refueled** are shown below. The default setting for “Trip A” Reset Timing is **Manual Reset**.

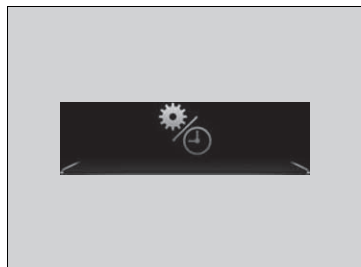

1. Press the  button to select , then press the **ENTER** button.

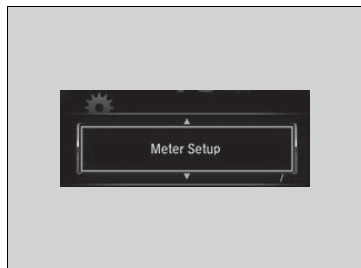

2. Press the  button until **Meter Setup** appears on the display.
3. Press the **ENTER** button.
 - ▶ **Language** appears first in the display.



4. Press the button until **“Trip A” Reset Timing** appears on the display, then press the **ENTER** button.

▶ The display switches to the customization setup screen, where you can select **When Fully Refueled**, **When Ignition Is Turned Off**, **Manual Reset**, or (Exit).



5. Press the button and select **When Fully Refueled**, then press the **ENTER** button.

▶ The **When Fully Refueled** screen appears, then the display returns to the customization menu screen.



6. Press the button until appears on the display, then press the **ENTER** button.

7. Repeat Step 6 until you return to the normal screen.

Head-up Display*

Shows the tachometer, shift lever position indicator*, traffic sign recognition system, or current mode for ACC with LSF* along with the vehicle speed. They are displayed when the power mode is in ON.

To turn the head-up display on and off: Press the **HUD** button.

The display can be moved up and down to come level with your eyes.

The head-up display will be displayed automatically when setting the power mode to ON, if it was displayed while you previously set the power mode to OFF.

To raise or lower the head-up display: Press and hold the ▲ or ▼ button until the desired position is reached.

Head-up Display*

If the head-up display was displayed while you set the power mode to OFF on your previous drive, when you set the power mode to ON, the angle of the head-up display is automatically adjusted according to the setting stored in the driving position memory system.

Avoid touching the screen of the head-up display as it is coated with a unique agent.

When you clean the screen, first blow away any debris or dust with a blower suited for cleaning camera lenses. Then gently wipe the lens with a lens cleaning cloth or other soft fine-grained cloth: Do not use a cleaner or detergent.

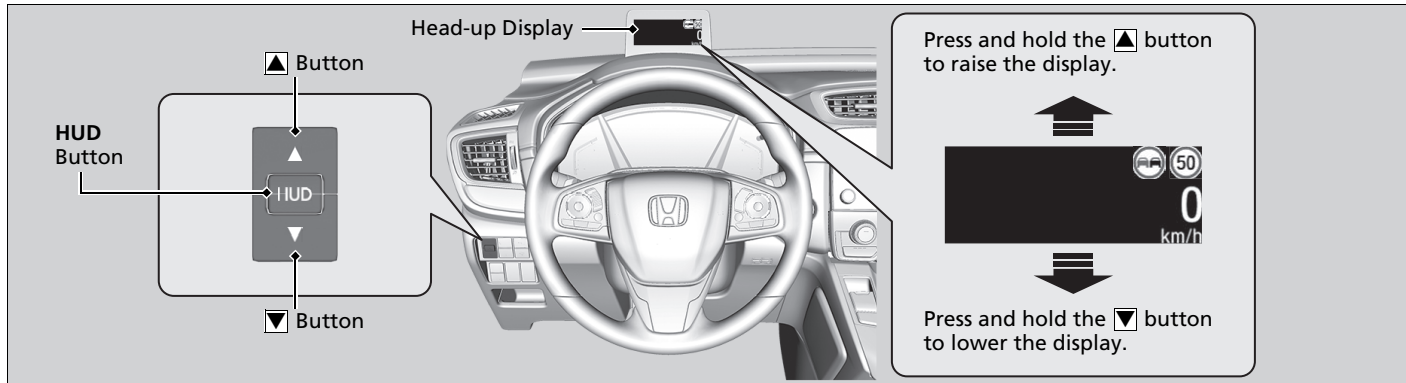

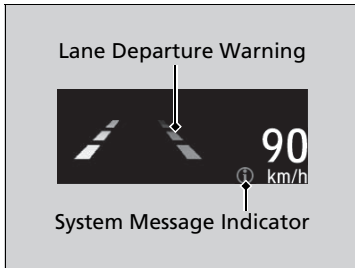

The display also shows the following warnings.

- **System Message Indicator:** Appears when a problem is detected. A system message on the driver information interface appears at the same time.
 - **Driver Information Interface Warning and Information Messages** P. 122
- **Lane Departure Warning:** When your vehicle is too close to the traffic lane lines, the lane departure warning appears.
 - **Lane Keeping Assist System (LKAS)** P. 604
- **Head-up Warning Lights:** Flash when the message appears on the driver information interface.
 - **Collision Mitigation Braking System (CMBS)** P. 561
 - **Adaptive Cruise Control (ACC) with Low Speed Follow (LSF)** P. 572
 - **Adaptive Cruise Control (ACC)** P. 589

■ Adjusting the Head-up Display Brightness

Pressing and holding the **HUD** button for few seconds enters the head-up display brightness adjusting mode. Use ▲ or ▼ button to adjust.

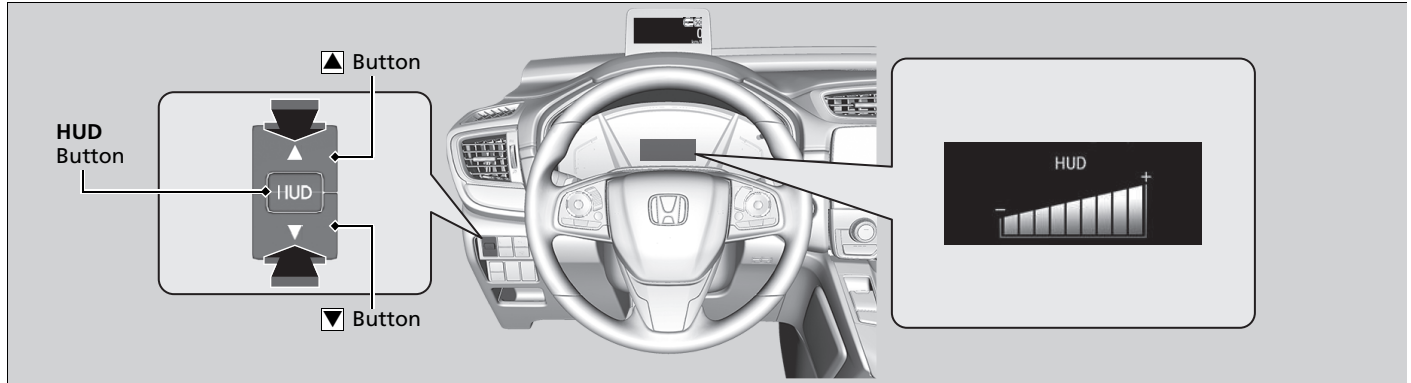

■ To Change Head-up Display Content

To change the number of items that come on along with the vehicle speed on the head-up display, do the following:
 Select the head-up display contents by pressing the ▲ / ▼ button to change the display.

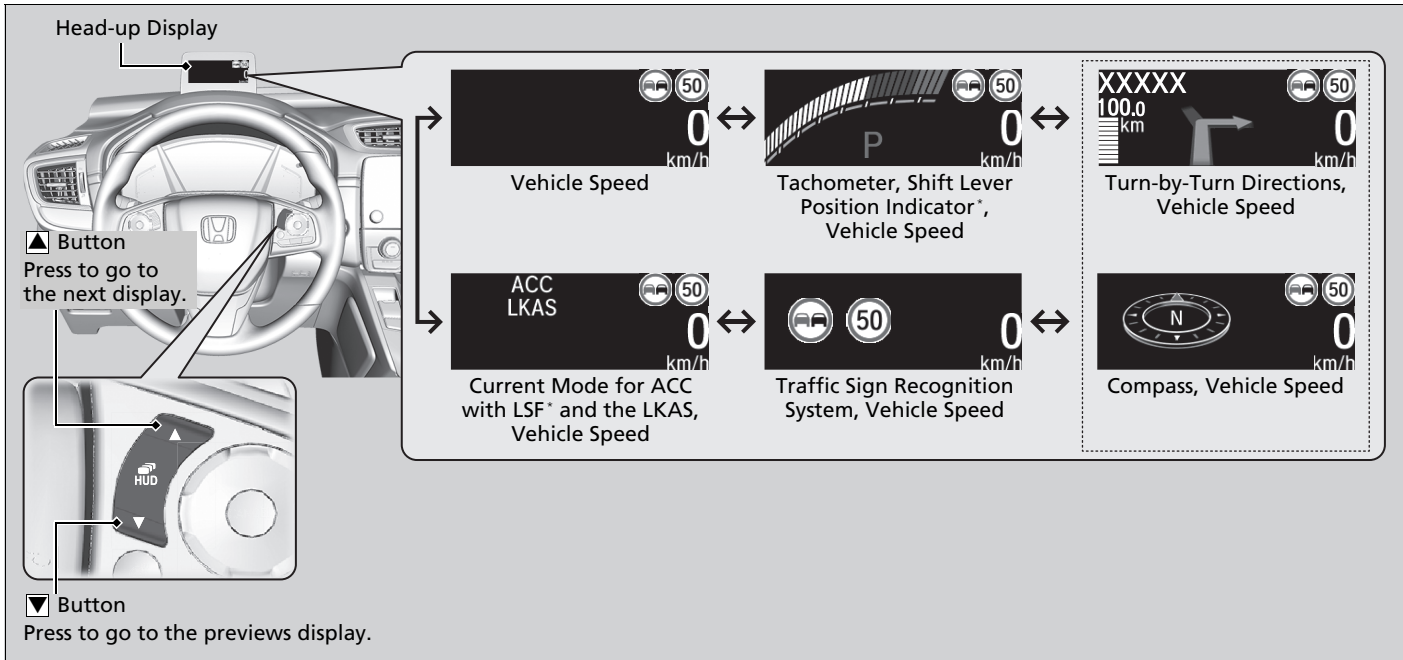

Instrument Panel

* Not available on all models

■ Vehicle Speed

Shows your driving speed in km/h or mph.

■ Tachometer

Shows the number of engine revolutions as a bar graph.

■ Shift Lever Position Indicator*

Shows the current shift lever position.

➤ **Shift Lever Position Indicator*** P. 102

■ Traffic Sign Recognition System

Shows the traffic sign recognition system.

➤ **Traffic Sign Recognition System** P. 618

■ Current Mode for ACC with LSF* and the LKAS

Shows the current mode for ACC with LSF* and the LKAS.

➤ **Adaptive Cruise Control (ACC) with Low Speed Follow (LSF)** P. 572

➤ **Adaptive Cruise Control (ACC)** P. 589

➤ **Lane Keeping Assist System (LKAS)** P. 604

■ Turn-by-Turn Directions

Shows you turn-by-turn driving directions to your destination linked with the navigation system.

➤ **Refer to the Navigation System Manual**

➤ Turn-by-Turn Directions

The head-up display shows a compass when the route guidance is not in use.

You can select whether the turn-by-turn display comes on or not during the route guidance.

➤ **Customized Features** P. 413

Controls

This chapter explains how to operate the various controls necessary for driving.



Clock	176
Locking and Unlocking the Doors	
Key Types and Functions	179
Low Keyless Remote Signal Strength* ..	181
Locking/Unlocking the Doors from the Outside	182
Locking/Unlocking the Doors from the Inside	189
Childproof Door Locks	191
Opening and Closing the Tailgate ...	192
Security System	
Immobilizer System	204
Security System Alarm	205
Ultrasonic Sensors*	207
Tilt Sensor*	208

Super Locking*	209
Opening and Closing the Windows	210
Panoramic Roof*	213
Operating the Switches Around the Steering Wheel	
Models without keyless access system	
Ignition Switch	217
Models with keyless access system	
ENGINE START/STOP Button	218
Ignition Switch and Power Mode Comparison	221
Turn Signals	222
Light Switches	223
Active Cornering Lights*	226
Fog Lights	227

Auto High-Beam (High Beam Support System) ..	229
Daytime Running Lights	232
Wipers and Washers	233
Brightness Control	237
Rear Demister/Heated Door Mirror Button....	240
Heated Windscreen Button*	241
Driving Position Memory System*	242
Adjusting the Steering Wheel	244
Adjusting the Mirrors	
Interior Rearview Mirror	245
Power Door Mirrors	246
Adjusting the Seats	249
Interior Lights/Interior Convenience Items	268
Climate Control System	290

* Not available on all models

Adjusting the Clock

Models without navigation system





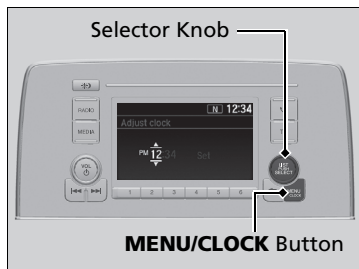

You can adjust the time in the clock display with the ignition switch in ON *1.

Adjusting the Time



Models with colour audio system

■ Using the MENU/CLOCK button

1. Press and hold the **MENU/CLOCK** button.
 - ▶ **Adjust clock** is selected.
2. Rotate  to change hour, then press .
3. Rotate  to change minute, then press .
4. To enter the selection, rotate  and select **Set**, then press .

▶▶ Adjusting the Clock

Models with navigation system

The clock is automatically updated through the navigation system, so the time does not need to be adjusted.

Models with colour audio system



You can customize the clock display to show the 12 hour clock or 24 hour clock.

➔ **Customized Features** P. 405

▶▶ Using the MENU/CLOCK button

Models with colour audio system

These indications are used to show how to operate the selector knob.

Rotate  to select.
Press  to enter.

*1: Models with the keyless access system have an **ENGINE START/STOP** button instead of an ignition switch.

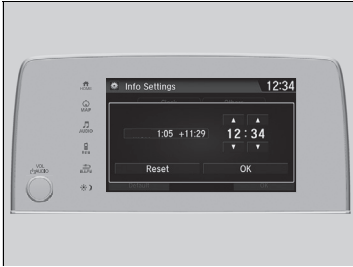

Models with Display Audio

■ Using the Settings menu on the audio/information screen

1. Select **Settings**.
2. Select **Clock**.
3. Select **Clock Adjustment**.
4. Select or to change hour.
5. Select or to change minute, then select **OK**.

▶▶ Using the Settings menu on the audio/information screen

Models with Display Audio

You can customize the clock display to show the 12 hour clock or 24 hour clock and turn the clock display on and off.

➤ **Customized Features** P. 413

Models with Display Audio

You cannot adjust the time while the vehicle is moving.

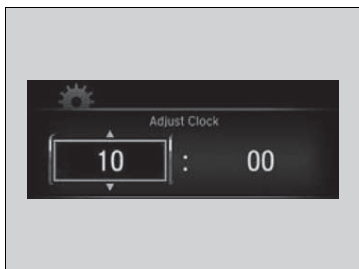

Models with colour audio system

■ Using the settings menu on the driver information interface

1. Press the button to select , then press the **ENTER** button.
2. Press the button until **Clock Setup** appears on the display.
3. Press the **ENTER** button.
4. Press the **ENTER** button to select **Adjust Clock**.

5. Press the button to change hour, then press the **ENTER** button.
6. Press the button to change minute, then press the **ENTER** button.
 - ▶ The display will return to the normal screen.

▶▶ Using the settings menu on the driver information interface

Models with colour audio system

You can customize the clock display to show the 12 hour clock or 24 hour clock and turn the clock display on and off.

➔ **Customized Features** P. 158

Models with Display Audio

The clock in the instrument panel also changes when the audio/information screen clock is adjusted.

Key Types and Functions

This vehicle comes with the following keys:

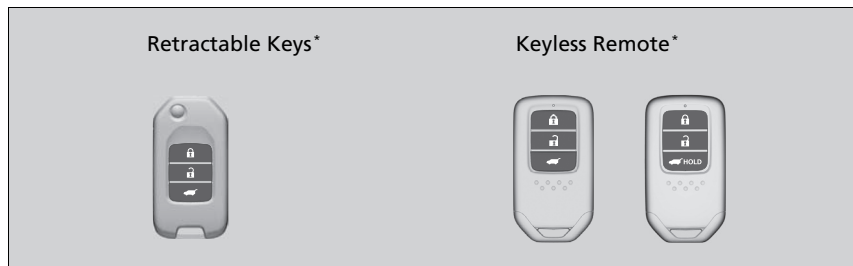

Use the keys to start and stop the engine, and to lock and unlock all the doors and tailgate.

You can also use the remote transmitter to lock and unlock all the doors and tailgate.

Built-in Key*

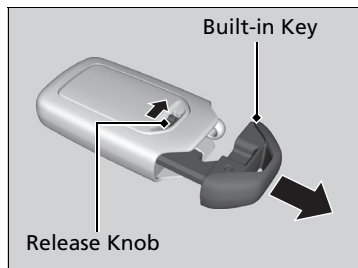

The built-in key can be used to lock/unlock the doors when the keyless remote battery becomes weak and the power door lock/unlock operation is disabled.

To remove the built-in key, slide the release knob and then pull out the key. To reinstall the built-in key, push the built-in key into the keyless remote until it clicks.

Key Types and Functions

All the keys have an immobilizer system. The immobilizer system helps to protect against vehicle theft.

Immobilizer System P. 204

Follow the advice below to prevent damage to the keys:

- Do not leave the keys in direct sunlight, or in locations with high temperature or high humidity.
- Do not drop the keys or set heavy objects on them.
- Keep the keys away from liquids, dust and sand.
- Do not take the keys apart except for replacing the battery.

If the circuits in the keys are damaged, the engine may not start, and the remote transmitter may not work.

If the keys do not work properly, have them inspected by a dealer.

* Not available on all models

■ Retractable Key*

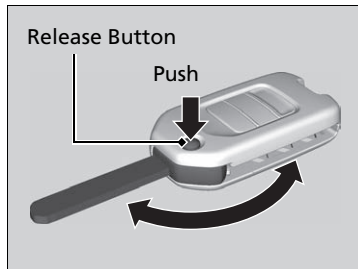

The key folds up inside the remote transmitter.

1. Press the release button to release the key out from the transmitter.
 - ▶ Make sure to fully extend the key.
2. To close the key, press the release button then push the key inside the transmitter until you hear a click.

■ Key Number Tag

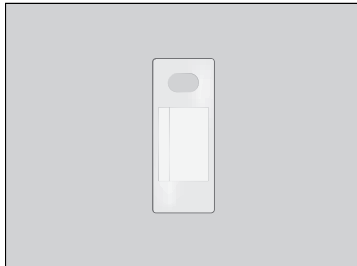

Contains a number that you will need if you purchase a replacement key.

☒ Retractable Key*

If the key is not fully extended, the immobilizer system may not work properly, and the engine may not start. Avoid contact with the key whenever it extends or retracts.

☒ Key Number Tag

Keep the key number tag separate from the key in a safe place outside of your vehicle. If you wish to purchase an additional key, contact a dealer.

If you lose your key and you cannot start the engine, contact a dealer.

Low Keyless Remote Signal Strength *

The vehicle transmits radio waves to locate the keyless remote when locking/unlocking the doors and tailgate, or to start the engine.

In the following cases, locking/unlocking the doors and tailgate, or starting the engine may be inhibited or operation may be unstable:

- Strong radio waves are being transmitted by nearby equipment.
- You are carrying the keyless remote together with telecommunications equipment, laptop computers, mobile phones, or wireless devices.
- A metallic object is touching or covering the keyless remote.

ⓘ Low Keyless Remote Signal Strength*

Communication between the keyless remote and the vehicle consumes the keyless remote's battery.

Battery life is about two years, but this varies depending on regularity of use.

The battery is consumed whenever the keyless remote is receiving strong radio waves. Avoid placing it near electrical appliances such as televisions and personal computers.

* Not available on all models

Locking/Unlocking the Doors from the Outside

■ Using the Keyless Access System *

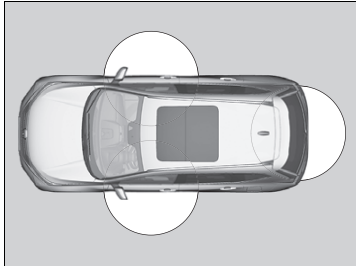

When you carry the keyless remote, you can lock/unlock the doors and open the tailgate. You can lock/unlock the doors and tailgate within a radius of about 80 cm of the outside door handle or tailgate outer handle.

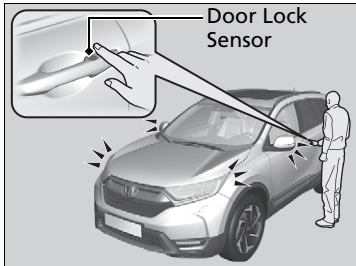

■ Locking the doors and tailgate

Touch the door lock sensor on the front door or press the lock button on the tailgate.

- ▶ Some exterior lights flash three times; all the doors and tailgate lock; and the security system sets.

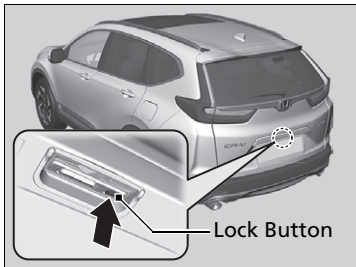

▣ Locking/Unlocking the Doors from the Outside

If the interior light switch is in the door activated position, the interior light comes on when you unlock the doors and tailgate.

No doors opened: The light fades out after 30 seconds.

Doors and tailgate relocked: The light goes off immediately.

➡ **Interior Lights** P. 268

▣ Using the Keyless Access System *

If you do not open a door or the tailgate within 30 seconds of unlocking the vehicle with the keyless access system, the doors and tailgate will automatically relock.

You can lock or unlock doors using the keyless access system only when the power mode is in VEHICLE OFF (LOCK).

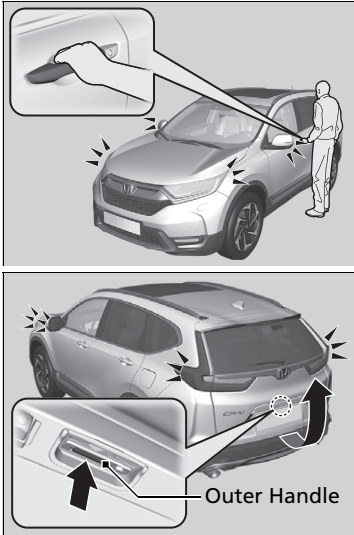

■ Unlocking the doors and tailgate

Grab the driver's door handle:

- ▶ The driver's door unlocks.
- ▶ Some exterior lights flash once.

Grab the front passenger's door handle:

- ▶ All the doors and tailgate unlock.
- ▶ Some exterior lights flash once.

Press the outer handle:

- ▶ The tailgate unlocks.
- ▶ Some exterior lights flash once.

🔍 **Using the Outer Handle** P. 202

🔍 Using the Keyless Access System*

- Do not leave the keyless remote in the vehicle when you get out. Carry it with you.
- Even if you are not carrying the keyless remote, you can lock/unlock the doors and the tailgate while someone else with the remote is within range.
- The door may be locked or unlocked if the door handle is covered with water in heavy rain or in a car wash if the keyless remote is within range.
- If you grip a front door handle or touch a door lock sensor wearing gloves, the door sensor may be slow to respond or may not respond by locking or unlocking the doors.
- After locking the door, you have up to 2 seconds during which you can pull the door handle to confirm whether the door is locked. If you need to unlock the door immediately after locking it, wait at least 2 seconds before gripping the handle, otherwise the door will not unlock.
- The door may not open if you pull it immediately after gripping the door handle. Grip the handle again and confirm that the door is unlocked before pulling the handle.
- Even within the 80 cm radius, you may not be able to lock/unlock the doors with the keyless remote if it is above or below the outside handle.
- The keyless remote may not operate if it is too close to the door and door glass.

* Not available on all models

» Using the Keyless Access System*

The door unlock mode settings can be customized using the driver information interface or audio/information screen.

Models with colour audio system

➔ **Customized Features** P. 158

Models with Display Audio

➔ **Customized Features** P. 413

The light flash settings can be customized using the driver information interface or audio/information screen.

Models with colour audio system

➔ **Customized Features** P. 158

Models with Display Audio

➔ **Customized Features** P. 413

Models with power tailgate

You can also unlock and open with the power tailgate.

➔ **Customized Features** P. 413

■ Using the Remote Transmitter

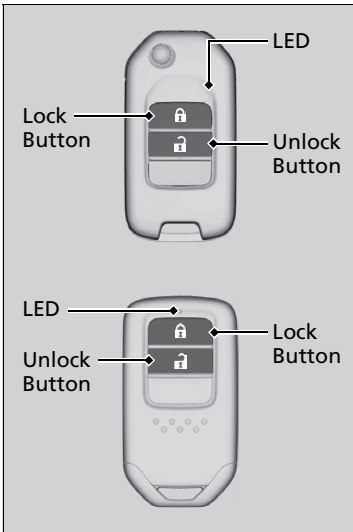

■ Locking the doors and tailgate

Press the lock button.

- ▶ Some exterior lights flash three times, all the doors and tailgate lock, and the security system sets.

■ Unlocking the doors and tailgate

Press the unlock button.

Once:

- ▶ Some exterior lights flash once, and the driver's door unlocks.

Twice:

- ▶ The remaining doors and tailgate unlock.

⌘ Using the Remote Transmitter

If you do not open a door or the tailgate within 30 seconds of unlocking the vehicle with the remote transmitter, the doors and tailgate will automatically relock. You can change the relock timer setting.

Models with colour audio system

➤ **Customized Features** P. 158

Models with Display Audio

➤ **Customized Features** P. 413

If the distance at which the remote transmitter works varies, the battery is probably low.

If the LED does not come on when you press a button, the battery is dead.

➤ **Replacing the Button Battery** P. 718

The remote transmitter will not work when:

Models without keyless access system

- The key is in the ignition switch.

Models with keyless access system

- The power mode is in ACCESSORY or ON.

» Using the Remote Transmitter

Models with keyless access system

Right-hand drive type

You cannot lock any doors from the outside when the keyless remote is inside the vehicle, and the beeper sounds. If you want to lock a door while the remote is still in the vehicle, do any of the following four times:

- Press the lock button on the keyless remote.
- Turn the key in the cylinder to lock.
- Press the door lock button on the door handle or the tailgate.

The remote transmitter uses low-power signals, so the operating range may vary depending on the surroundings.

The remote will not lock the vehicle when a door is open.

You can customize the door unlock mode setting.

Models with colour audio system

➤ **Customized Features** P. 158

Models with Display Audio

➤ **Customized Features** P. 413

■ Locking/Unlocking the Doors Using a Key

If the lock or unlock button of the remote does not work, use the key instead.
Fully insert the key and turn it.

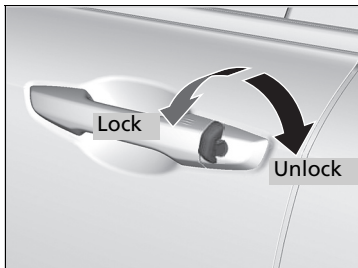

▣ Locking/Unlocking the Doors Using a Key

When you lock the driver's door with the key, all the other doors and tailgate lock at the same time. When unlocking, the driver's door unlocks first. Turning the key a second time within a few seconds does not unlock the remaining doors and the tailgate.

You can customize the door unlock mode setting.

Models with colour audio system

➤ **Customized Features** P. 158

Models with Display Audio

➤ **Customized Features** P. 413

Unlocking the doors with the key causes the security system to alarm. Always unlock the doors with the remote transmitter.

■ Locking a Door Without Using a Key

If you do not have the key on you, or if for some reason you cannot lock a door using the key, you can lock the door without it.

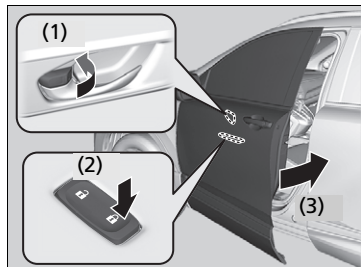

■ Locking the driver's door

Push the lock tab forward (1) or push the master door lock switch in the lock direction (2), then pull and hold the outside door handle (3). Close the door, then release the handle.

■ Locking the passenger's doors

Push the lock tab forward and close the door.

■ Lockout prevention system

Models without keyless access system

The doors and tailgate cannot be locked when the key is in the ignition switch.

Models with keyless access system

The doors and tailgate cannot be locked when the keyless remote is inside the vehicle.

▶ Locking a Door Without Using a Key

When you lock the driver's door, all the other doors and tailgate lock at the same time.

Before locking a door, make sure that the key is not inside the vehicle.

Locking/Unlocking the Doors from the Inside

■ Using the Lock Tab

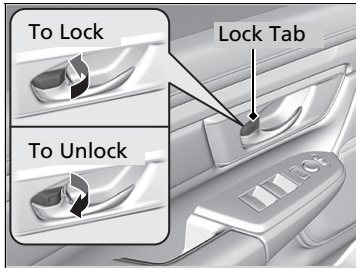

■ Locking a door

Push the lock tab forward.

■ Unlocking a door

Pull the lock tab rearward.

☒ Using the Lock Tab

When you lock the door using the lock tab on the driver's door, all the other doors and tailgate lock at the same time.

When you unlock the door using the lock tab on the driver's door, only the driver's door will unlock.

■ Unlocking Using the Front Door Inner Handle

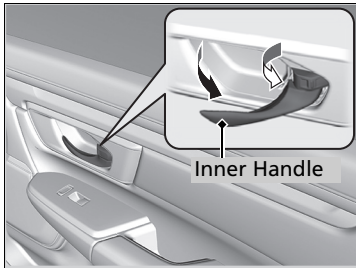

Pull the front door inner handle.

- ▶ The door unlocks and opens in one motion.

☒ Unlocking Using the Front Door Inner Handle

The front door inner handles are designed to allow front seat occupants to open the door in one motion. However, this feature requires that front seat occupants never pull a front door inner handle while the vehicle is in motion.

Children should always ride in a rear seat where childproof door locks are provided.

☒ **Childproof Door Locks** P. 191

■ Using the Master Door Lock Switch

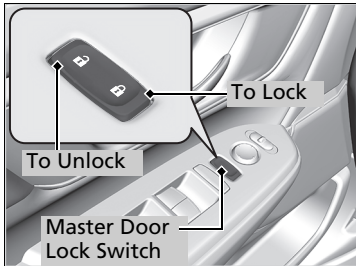

Press the master door lock switch in as shown to lock or unlock all the doors and the tailgate.

☒ Using the Master Door Lock Switch

When you lock/unlock either front door using the master door lock switch, all the other doors and the tailgate lock/unlock at the same time.

Childproof Door Locks

The childproof door locks prevent the rear doors from being opened from the inside regardless of the position of the lock tab.

■ Setting the Childproof Door Locks

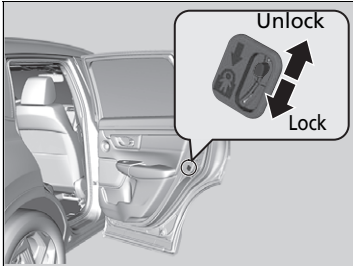

Slide the lever in the rear door to the lock position, and close the door.

■ When opening the door

Open the door using the outside door handle.

☒ Childproof Door Locks

To open the door from the inside when the childproof door lock is on, put the lock tab in the unlock position, lower the rear window, put your hand out of the window, and pull the outside door handle.

Precautions for Opening/Closing the Tailgate

Always make sure individuals and objects are clear of the tailgate before opening or closing it.

Models without power tailgate

- Open the tailgate all the way.
 - ▶ If it is not fully opened, the tailgate may begin to close under its own weight.
- Be careful when it is windy. The wind may cause the tailgate to close.

All models

Keep the tailgate closed while driving to:

- ▶ Avoid possible damage.
- ▶ Prevent exhaust gas from leaking into the vehicle.
 - **Carbon Monoxide Gas** P. 94

Precautions for Opening/Closing the Tailgate

WARNING

Anyone caught in the path of a tailgate that is being opened or closed can be seriously injured.

Make sure that all people are clear of the tailgate before opening or closing it.

Be careful not to hit your head on the tailgate or to put your hands between the tailgate and the luggage area when closing the tailgate.

When you are storing or picking up luggage from the luggage area, or using a forward and back kicking motion under the centre of the rear bumper for hands free access*, while the engine is idling, do not stand in front of the exhaust pipe. You may get burned.

Do not allow any passenger in the luggage space. They may get hurt during hard braking, a sudden acceleration, or a crash.

Models with power tailgate

The power tailgate can be operated by pressing the power tailgate button on the remote transmitter, pressing the power tailgate button in the driver side control panel, pressing the outer handle or button on the tailgate, or by raising and lowering your foot under the centre of the rear bumper for hands free access.

Continuously variable transmission models

The power tailgate can be opened/closed when the transmission is in **P**.

Manual transmission models

The power tailgate can be opened/closed when the parking brake is applied.

⌘ Precautions for Opening/Closing the Tailgate

Models with power tailgate

⚠ WARNING

Opening or closing a power tailgate while any part of a passenger is in the tailgate's operating path can cause serious injury. Make sure all passengers or objects are clear of the tailgate operating range before opening or closing the tailgate.

WARNING: Always take the ignition key with you whenever you leave the vehicle alone or with other occupants.

NOTICE

Do not push or pull on the power tailgate when it is being automatically opened or closed. Forcibly opening or closing the power tailgate while in operation can deform the tailgate frame.

When operating the power tailgate, make sure there is enough space around your vehicle. People near the tailgate may be seriously hurt if the tailgate hits or closes on their heads. Be especially cautious if children are around.

» Precautions for Opening/Closing the Tailgate

Models with power tailgate

The power tailgate may not open or close under the following conditions:

- You start the engine while the tailgate is automatically opening or closing.
- The vehicle is parked on a steep hill.
- The vehicle is swayed in a strong wind.
- The tailgate or the roof is covered with snow or ice.

If you close the power tailgate with all the doors locked, the power tailgate locks automatically and some exterior lights flash.

Opening/Closing the Power Tailgate*

■ Using the Hands Free Access

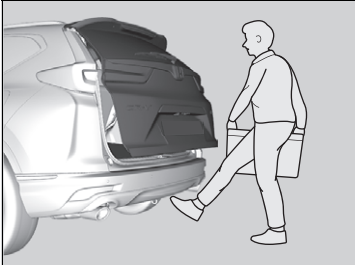

Use a forward and back kicking motion under the centre of the rear bumper to open or close the power tailgate while carrying the keyless remote.

- ▶ Some exterior lights flash twice, then the tailgate begins to move.

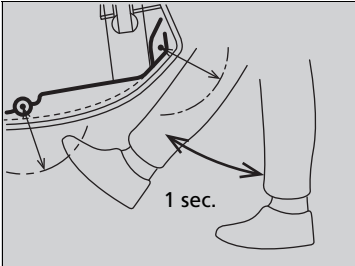

☒ Using the Hands Free Access

During heavy rain or in other instances when the vehicle becomes very wet, the sensor may not properly detect your foot motion.

When performing work on or around the rear section of the vehicle, you may inadvertently open or close the tailgate.

To prevent this from happening, select Customized Features on the audio/information screen and then select OFF for the feature.

➤ **Customized Features** P. 413

If you hold your foot under the bumper for too long, the power tailgate does not open or close.

This function will not operate if you don't have the keyless remote on you. Please make sure you have the keyless remote on you.

The duration of the kicking motion should be approximately one second.

■ Using the Remote Transmitter

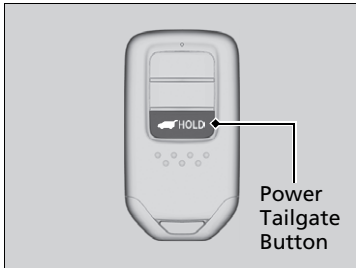

Press the power tailgate button for more than one second to operate when the power mode is in VEHICLE OFF (LOCK).

▶ Some exterior lights flash three times.

If you press the button again while the power tailgate is moving, it will stop. Press the button for more than one second, and the power tailgate will reverse direction.

■ Customizing when to open the tailgate

Anytime: The power tailgate unlocks and opens at the same time. This is the default setting.

When Unlocked: The tailgate opens when all doors are unlocked.

📖 **Customized Features** P. 405

📖 Opening/Closing the Power Tailgate*

If you close the power tailgate when all the doors are locked, the power tailgate locks automatically.

If you replace the battery or the power tailgate fuse while the tailgate is open, the power tailgate may be disabled. The power tailgate resumes once you manually close the tailgate.

Installing aftermarket components other than genuine Honda accessories on the power tailgate may prevent it from fully opening or closing.

Make sure the power tailgate is fully open before you get your luggage in and out.

Make sure the power tailgate is fully closed before you start the vehicle.

The beeper sounds when you start driving while the power tailgate is still open, or closing.

■ Using the Power Tailgate Button

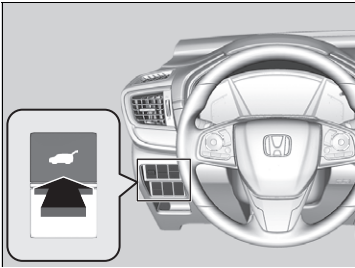

To open or close the power tailgate, press the power tailgate button for about one second.

- ▶ Some exterior lights flash three times.

If you press the button again while the power tailgate is moving, it will stop. Press the button for about one second, and the power tailgate will reverse direction.

☒ Opening/Closing the Power Tailgate*

If the power tailgate meets resistance while opening or closing, the auto reverse feature reverses the direction. The beeper sounds three times.

The auto reverse function stops sensing when the tailgate is almost closed to make sure that it fully closes.

Do not touch the sensors located on both sides of the tailgate. The power tailgate does not close if you touch either sensor when you are trying to close the tailgate.

Be careful not to scratch the sensors with a sharp object. If scratched, they can be damaged, and the power tailgate closing feature malfunctions.

* Not available on all models

■ Using the Tailgate Outer Handle

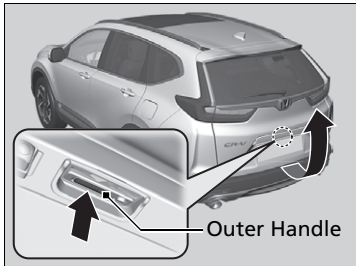

If you press the outer handle of the tailgate for no longer than one second, the tailgate opens automatically.

- ▶ If you want to open the tailgate manually, press the button for more than one second.

➤ **Opening and Closing the Tailgate** P. 192

If you are carrying the keyless remote, you do not have to unlock the tailgate before opening it.

To close the tailgate, press the outer handle again while the tailgate opening.

If you press the outer handle again while the power tailgate is moving, it will stop. Press the outer handle, and the power tailgate will reverse direction.

➤ Opening/Closing the Power Tailgate*

- Do not leave the key in the vehicle when you get out. Carry it with you.
- Even if you are not carrying the keyless remote, you can unlock the tailgate while someone else with the remote is within range.
- Do not leave the keyless remote inside the luggage area and close the tailgate. The beeper sounds and the tailgate cannot be locked.

You can change the power tailgate operation setting on and off.

➤ **Customized Features** P. 405

■ Using the Tailgate Inner Button



Press the button on the tailgate to close the power tailgate.

If you press the button again while the power tailgate is moving, it will stop.
Press and release the button again, and the power tailgate will reverse direction.

■ Programming Tailgate Position

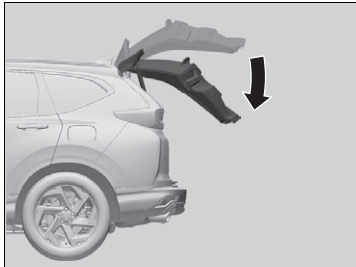

The extent to which the power tailgate automatically opens can be programmed.

To program:

1. Open the tailgate to the desired position.
 - ▶ If you want to reprogram the power tailgate to open all the way, manually raise the tailgate to its upper most position and follow the next step.
2. Press and hold the tailgate inner button until you hear short two beeps following one long buzzer.

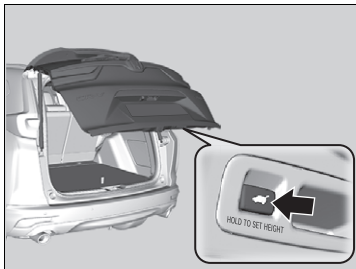

▣ Programming Tailgate Position

If the tailgate is only slightly opened, the position cannot be programmed, even if you push the inner button.

Auto-Closer

If you manually close the power tailgate, it latches automatically.

Power Tailgate Fall Detection

Automatically lowers the power tailgate when there is a possibility that the fully opened power tailgate can fall down by its own weight (for example, by snow on the tailgate). The beeper sounds while the power tailgate lowers.

Auto-Closer

The auto-closer feature does not activate if you push the tailgate outer handle while the power tailgate is closing.

Do not put any force on the tailgate while the power tailgate is latching.

Keep your hands away from the tailgate when you manually close the tailgate and let it latch automatically. It is dangerous to put your hands around the tailgate as it starts to latch itself.

Power Tailgate Fall Detection

If you try to manually close the power tailgate immediately after it fully opens, the power tailgate fall detection may activate

Once the power tailgate fall detection activates, wait until the power tailgate fully closes. Keep away from the power tailgate when it is in motion.

If the power tailgate fall detection constantly activates, consult at a dealer.

Opening/Closing the Tailgate

■ Using the Outer Handle

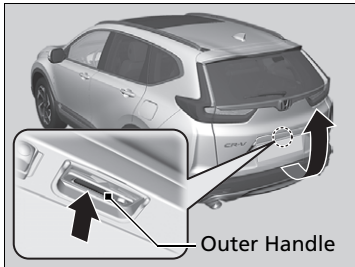

When all the doors are unlocked or press the tailgate unlock button on the remote transmitter, the tailgate is unlocked. Press the outer handle and lift open the tailgate.

Models with keyless access system

If you are carrying the keyless remote, you do not have to unlock the tailgate before opening it.

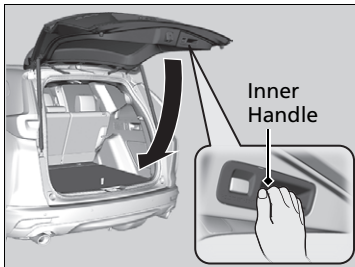

To close the tailgate, grab the inner handle, pull the tailgate down, and push it closed from outside.

If you close the tailgate when the driver's door is locked, the tailgate locks automatically.

- ▶ Some exterior lights flash three times.

▶▶ Using the Outer Handle

Models with keyless access system

- Do not leave the keyless remote in the vehicle when you get out. Carry it with you.
- Even if you are not carrying the keyless remote, you can unlock the tailgate while someone else with the remote is within range.
- Do not leave the keyless remote inside the luggage area and close the tailgate. The beeper sounds and the tailgate cannot be locked.

■ Using the Remote Transmitter*

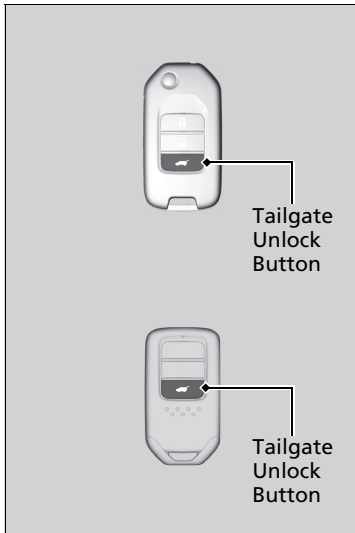

Press the tailgate unlock button to unlock the tailgate.

▣ Using the Remote Transmitter*

If you have unlocked and opened the tailgate using the remote transmitter or keyless remote*, when closing, the tailgate locks automatically.

* Not available on all models

Immobilizer System

The immobilizer system prevents a key that has not been pre-registered from starting the engine. Each key contains electronic transmitters that use electronic signals to verify the key.

Pay attention to the following when inserting the key into the ignition switch* or pressing the **ENGINE START/STOP** button*:

- Do not allow objects that emit strong radio waves near the ignition switch* or the **ENGINE START/STOP** button*.
- Make sure the key is not covered by or touching a metal object.
- Do not bring a key from another vehicle's immobilizer system near the ignition switch* or the **ENGINE START/STOP** button*.

Do not put the key near magnetic items. Electronic device, such as televisions and audio systems emit strong magnetic fields. Note that even a key chain can become magnetic.

*1: Models with the keyless access system have an **ENGINE START/STOP** button instead of an ignition switch.

* Not available on all models

Immobilizer System

NOTICE

Leaving the key in the vehicle can result in theft or accidental movement of the vehicle.

Always take the key with you whenever you leave the vehicle unattended.

Do not alter the system or add other devices to it. Doing so may damage the system and make your vehicle inoperable.

If the system repeatedly does not recognise the coding of your key, contact your dealer. If you have lost your key and cannot start your engine, contact a dealer.

Right-hand drive type

Apply and hold the brake pedal before turning the ignition switch to ON *1 the first time after the battery has been disconnected.

Security System Alarm

The security system alarm activates when the tailgate, bonnet, or doors are opened without the remote transmitter, or keyless access system*.

■ When the security system alarm activates

The horn sounds intermittently and all the exterior lights flash.

■ To deactivate the security system alarm

Unlock the vehicle using the remote transmitter, keyless access system*, or turning the ignition switch to ON **[II]***1. The system, along with the horn and flashing lights, is deactivated.

■ Setting the security system alarm

Models without keyless access system

The security system alarm automatically sets when the following conditions have been met:

- The ignition switch is in LOCK **[0]**, and the key has been removed from the ignition switch.
- The bonnet is closed.
- All doors and the tailgate are locked with the key or the remote transmitter.

*1: Models with the keyless access system have an **ENGINE START/STOP** button instead of an ignition switch.

* Not available on all models

▣ Security System Alarm

Do not attempt to alter this system or add other devices to it.

Doing so may damage the system and make your vehicle inoperable.

The security alarm will continue for approximately 5 minutes before the security system deactivates.

The system will go through ten 30-second cycles, during which the horn will sound and an emergency indicator will flash.

Depending on circumstances, the security system may continue operating for more than 5 minutes.

Do not set the security system alarm when someone is in the vehicle or a window is open. The system can accidentally activate when:

- Unlocking the door with the lock tab.
- Opening the bonnet with the bonnet release handle.

If the battery goes dead after you have set the security system alarm, the security alarm may activate once the battery is recharged or replaced. If this occurs, deactivate the security system alarm by unlocking a door using the remote transmitter or keyless access system*.

Do not unlock the door using the key. The security system alarm activates.

Models with keyless access system

The security system alarm automatically sets when the following conditions have been met:

- The power mode is set to VEHICLE OFF (LOCK).
- The bonnet is closed.
- All doors and the tailgate are locked from outside with the key, remote transmitter, or keyless access system.

■ When the security system alarm sets

The security system alarm indicator in the instrument panel blinks. When the blinking interval changes after about 15 seconds, the security system alarm is set.

■ To cancel the security system alarm

Models without keyless access system

The security system alarm is cancelled when the vehicle is unlocked using the remote transmitter or the ignition switch is turned to ON. The security system alarm indicator goes off at the same time.

Models with keyless access system

The security system alarm is cancelled when the vehicle is unlocked using the remote transmitter or keyless access system, or the power mode is set to ON. The security system alarm indicator goes off at the same time.

» Security System Alarm

Models with ultrasonic sensors or tilt sensor

The system may accidentally activate such as when:

- The vehicle is parked in an automated garage.
- The vehicle is being washed with highly pressurized water or being put through an automated car wash.
- The vehicle is being transported by train, ferry or trailer.
- The vehicle is subjected to heavy rain or stormy weather.
- Ice is being removed from the vehicle.

You can use ultrasonic sensor **OFF** button and Tilt sensor **OFF** button not to accidentally activate the security system alarm.

➤ **Ultrasonic Sensors*** P. 207

➤ **Tilt Sensor*** P. 208

Ultrasonic Sensors*

The ultrasonic sensors activate only when the security system alarm is set. If the sensors detect an intruder moving around inside or entering the interior of the vehicle through a window, the sensor will activate the alarm.

■ To set the security system alarm without activating the ultrasonic sensors

You can set the security system alarm without activating the ultrasonic sensors.

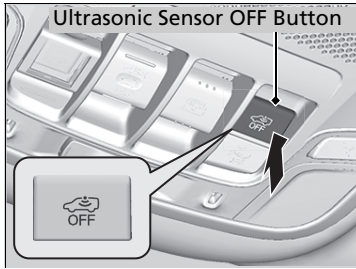

To turn off the ultrasonic sensor system, press the ultrasonic sensor OFF button after you remove the key from the ignition switch, or with the key in the ACCESSORY **I** or LOCK **0***1.

▶ The  is on in red.

To turn it on again, press the ultrasonic sensor OFF button.

Ultrasonic sensors is turned on every time you set the security system alarm, even if you turned it off the last time.

*1: Models with the keyless access system have an **ENGINE START/STOP** button instead of an ignition switch.



* Not available on all models

⊗ Ultrasonic Sensors*

Whether the ultrasonic sensors has been activated or not, the security system can only be turned off by the remote transmitter or keyless access system*, not the key.

It is possible to confirm whether the vehicle security system was activated without your knowledge. If the security system has been activated, the  will blink for 5 minutes after you unlock the door and disable the system.

If, however, you start the engine, the  will stop blinking after 5 seconds.

If the ultrasonic sensor is malfunctioning or there is another problem, the  will come on for 5 minutes after you unlock the door and disable the system. If, however, you start the engine, the  will shut off.

The security system may accidentally activate by ultrasonic sensors such as when:

- Someone is in the vehicle
- A window is open
- Accessories or clothes are hanging in the vehicle.

Tilt Sensor*

The tilt sensor activates only when the security system alarm is set. If someone raises the vehicle in an attempt to tow the vehicle or remove the wheels etc., the sensor will activate the alarm.

■ To set the security system alarm without activating the tilt sensor

You can set the security system alarm without activating the tilt sensor.

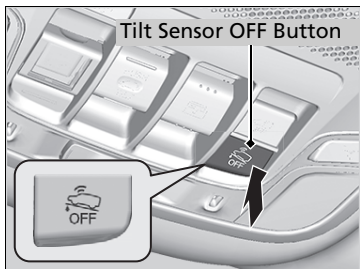

To turn off the tilt sensor system, press the tilt sensor OFF button after you remove the key from the ignition switch, or with the key in the ACCESSORY **I** or LOCK **0***1.

▶ The  is on in red.

To turn it on again, press the tilt sensor OFF button.

Tilt sensor is turned on every time you set the security system alarm, even if you turned it off the last time.

⌘ Tilt Sensor*

Whether the tilt sensor has been activated or not, the security system can only be turned off by the remote transmitter or keyless access system*, not the key.

It is possible to confirm whether the vehicle security system was activated without your knowledge. If the security system has been activated, the  will blink for 5 minutes after you unlock the door and disable the system.

If, however, you start the engine, the  will stop blinking after 5 seconds.

If the tilt sensor is malfunctioning or there is another problem, the  will come on for 5 minutes after you unlock the door and disable the system.

If, however, you start the engine, the  will shut off.

Do not set the tilt sensor when the vehicle is lifted or jacked up.

*1: Models with the keyless access system have an **ENGINE START/STOP** button instead of an ignition switch.

* Not available on all models

Super Locking*

The super locking function disables the lock tabs on all doors.

■ To activate the super locking function

- Turn the key in the driver's door towards the vehicle front twice within five seconds.
- Press the lock button on the remote transmitter twice within five seconds.

Models with keyless access system

- Touch the door lock sensor on the door handle or press the lock button on the tailgate twice within five seconds.

■ To cancel the super locking function

Unlock the driver's door with the remote transmitter or keyless access system*.

Super Locking*

⚠ WARNING

No one must be inside the vehicle with the super locking set. Persons locked in can get seriously sick or die from the heat built inside the vehicle if left in the sun.

Make sure there is no one inside the vehicle before setting the super locking.

Do not unlock the door using the key. The security system alarm activates.

Even if you have unlocked, opened, and then closed the tailgate, the super locking function continues to be in effect.

* Not available on all models

Opening/Closing the Power Windows

The power windows can be opened and closed when the ignition switch is in ON *1, using the switches on the doors.

The driver side switches can be used to open and close all the windows. The power window lock button on the driver side must be switched off (not pushed in, indicator off) to open and close the windows from anywhere other than the driver's seat.

When the power window lock button is switched on (pushed in, indicator on), you can only operate the driver's window. Turn the power window lock button on if a child is in the vehicle.

Opening/Closing the Power Windows

WARNING

Closing a power window on someone's hands or fingers can cause serious injury.

Make sure your passengers are away from the windows before closing them.

WARNING: Always take the ignition key with you whenever you leave the vehicle alone or with other occupants.

The power windows can be operated for up to 10 minutes after you turn the ignition switch to LOCK *1.
Closing the driver's door cancels this function.

Opening/Closing Windows with Auto-Open/Close Function

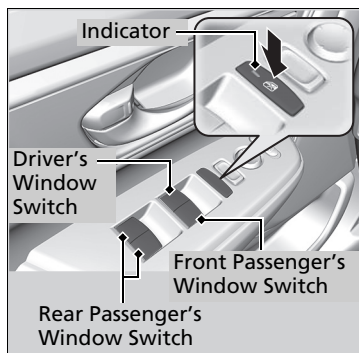

Manual operation

To open: Push the switch down lightly, and hold it until the desired position is reached.

To close: Pull the switch up lightly, and hold it until the desired position is reached.

Automatic operation

To open: Push the switch down firmly.

To close: Pull the switch up firmly.

The window opens or closes completely. To stop the window at any time, push or pull the switch briefly.

*1: Models with the keyless access system have an **ENGINE START/STOP** button instead of an ignition switch.

■ Opening/Closing Windows and the Panoramic Roof* with the Remote

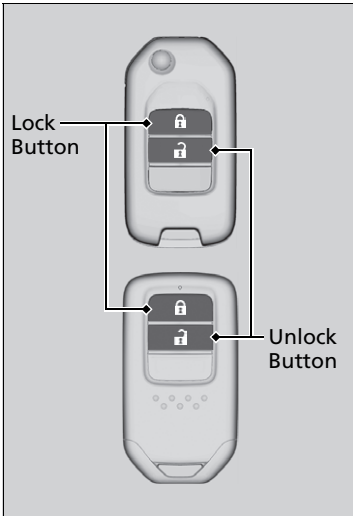

To open: Press the unlock button, and then within 10 seconds, press it again and hold it.

To close: Press the lock button, and then within 10 seconds, press it again and hold it.

If the windows and panoramic roof stop midway, repeat the procedure.

☒ Opening/Closing the Power Windows

Auto Reverse

If a power window senses resistance when closing automatically, it will stop closing and reverse direction.

The driver's window auto reverse function is disabled when you continuously pull up the switch.

The auto reverse function stops sensing when the window is almost closed to ensure that it fully closes.

You cannot fully open the rear windows.

* Not available on all models

■ Closing Windows and the Panoramic Roof* with the Key

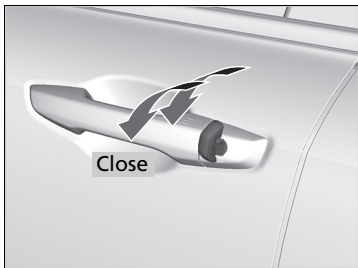

To close: Lock the driver's door with the key. Within 10 seconds of returning the key to the central position, turn the key in the lock direction and hold it there.

Release the key to stop the windows and panoramic roof at the desired position. If you want further adjustment, repeat the same operation.

Opening/Closing the Panoramic Roof

You can only operate the panoramic roof when the power mode is in ON. Use the switch in the front of the ceiling to open and close the panoramic roof.

Opening/Closing the Panoramic Roof

WARNING

Opening or closing the panoramic roof on someone's hands or fingers can cause serious injury.

Make sure all hands and fingers are clear of the panoramic roof before opening or closing it.

WARNING: Always take the ignition key with you whenever you leave the vehicle alone or with other occupants.

NOTICE

Opening the panoramic roof in below freezing temperature or when it is covered with snow or ice can damage the panoramic roof panel or motor.

The panoramic roof and sunshade can be operated for up to 10 minutes after you set the power mode to OFF (LOCK).
Closing the driver's door cancels this function.

▶▶ Opening/Closing the Panoramic Roof

When resistance is detected, the auto reverse function causes the panoramic roof to change directions, then stop. Auto reverse stops sensing when the panoramic roof is almost closed to ensure that it fully closes. Make sure that all objects, including fingers, are clear of the panoramic roof.

You can use the remote transmitter or the key to operate the panoramic roof.

- ▶▶ **Opening/Closing Windows and the Panoramic Roof* with the Remote** P. 211
- ▶▶ **Closing Windows and the Panoramic Roof* with the Key** P. 212

■ Using the Sunshade Switch

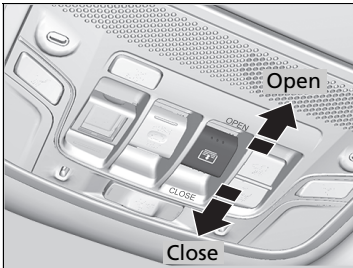

■ Automatic operation

To open: Pull the switch back firmly.

To close: Push the switch forward firmly.

The sunshade automatically opens or closes all the way. To stop the sunshade midway, push the switch briefly.

■ Manual operation

To open: Pull the switch back lightly, and hold it until the desired position is reached.

To close: Push the switch forward lightly, and hold it until the desired position is reached.

☒ Using the Sunshade Switch

The sunshade can be opened or closed to adjust the amount of light that enters the cabin.

When you use the sunshade switch to open the sunshade, the panoramic roof does not move.

The sunshade cannot be fully closed if the panoramic roof is open. When you close the sunshade with the panoramic roof open, the sunshade stops close to the panoramic roof glass. When you push the switch forward again, the sunshade and the panoramic roof close together.

■ Using the Panoramic Roof Switch

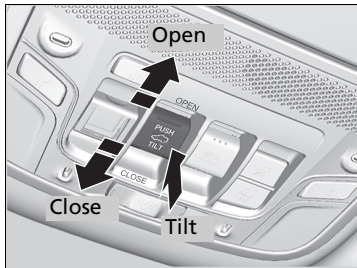

■ Automatic operation

To open: Pull the switch back firmly.

To close: Push the switch forward firmly.

The panoramic roof automatically opens or closes all the way. To stop the panoramic roof midway, push the switch briefly.

■ Manual operation

To open: Pull the switch back lightly, and hold it until the desired position is reached.

To close: Push the switch forward lightly, and hold it until the desired position is reached.

■ Tilting the panoramic roof up

To tilt: Push on the centre of the panoramic roof switch.

To close: Push the switch forward firmly, then release.

Opening the panoramic roof in below freezing temperature or when it is covered with snow or ice can damage the panoramic roof panel or motor.

►► Using the Panoramic Roof Switch

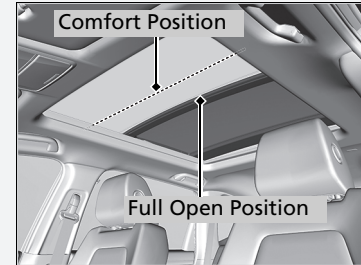

The panoramic roof cannot be fully opened in a single operation. The panoramic roof has a “comfort” position or wind noise reduction position at which the roof first stops. To open fully, pull the switch back again after the roof has stopped at this position.

Whenever the panoramic roof is opening, the sunshade moves along with it. However, when the panoramic roof is closing, the sunshade does not move.

When you tilt open the panoramic roof, the sunshade opens slightly to let in fresh air. When you close the panoramic roof from this position, the sunshade returns to its closed position.

Operating the Switches Around the Steering Wheel

Models without keyless access system

Ignition Switch



- 0** LOCK: Insert and remove the key in this position.
- I** ACCESSORY: Operate the audio system and other accessories in this position.
- II** ON: This is the position when driving.
- III** START: This position is for starting the engine. The switch returns to ON **II** when you let go of the key.

Ignition Switch

Manual transmission models

⚠ WARNING

Removing the key from the ignition switch while driving locks the steering. This can cause you to lose control of the vehicle.



Remove the key from the ignition switch only when parked.

Continuously variable transmission models

You cannot take the key out unless the shift lever is in **P**.

All models

If you open the driver's door when the key is in LOCK **0** or ACCESSORY **I**, the following messages appear on the driver information interface:

- In LOCK **0**:  or the symbol with a **Ignition Key**
- In ACCESSORY **I**:  or the symbol with a **Return IGN Switch To (0) Position**

If the key won't turn from LOCK **0** to ACCESSORY **I**, turn the key while moving the steering wheel left and right. The steering wheel will unlock, allowing the key to turn.

Models with keyless access system

ENGINE START/STOP Button

Changing the Power Mode

Controls

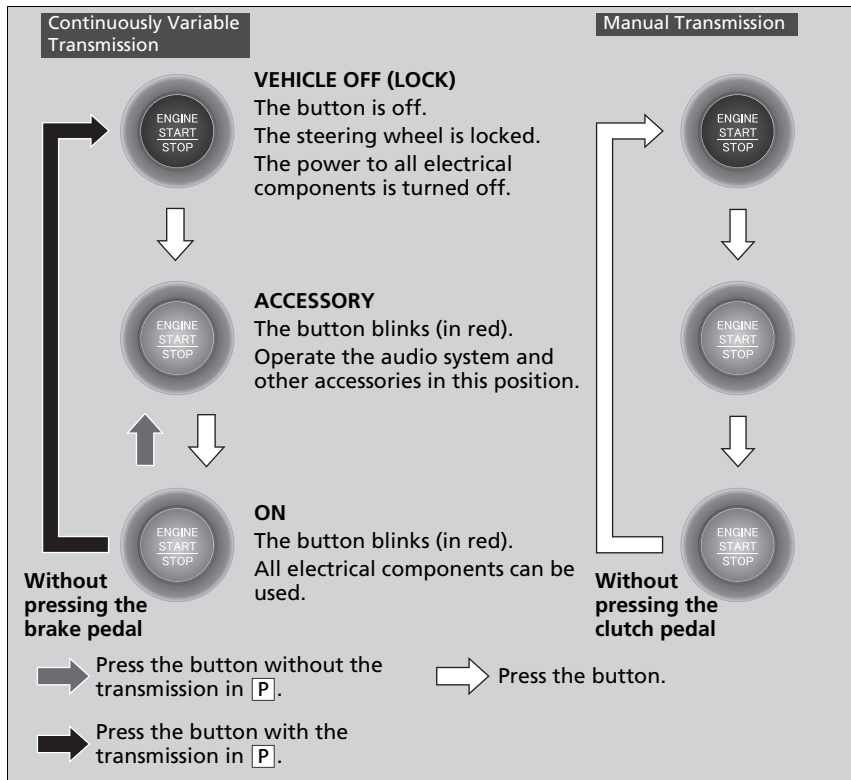

ENGINE START/STOP Button

ENGINE START/STOP Button Operating Range

You can start the engine when the keyless remote is inside the vehicle.

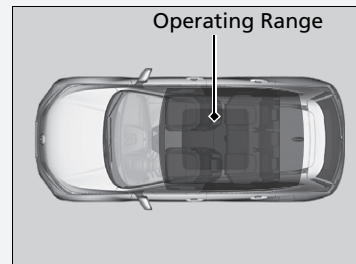

If the battery of the keyless remote is getting low, the engine may not start when you push the **ENGINE START/STOP** button. If the engine does not start, refer to the following link.

➡ **If the Keyless Remote Battery is Weak**
P. 744

The engine may also run if the keyless remote is close to the door or window, even if it is outside the vehicle.

ON mode:

The **ENGINE START/STOP** button is red when the engine is running.

The engine may also run if the keyless remote is close to the door or window, even if it is outside the vehicle.

■ Automatic Power Off

If you leave the vehicle for 30 to 60 minutes with the transmission in **P** (continuously variable transmission) and the power mode in ACCESSORY, the vehicle automatically goes into the mode similar to VEHICLE OFF (LOCK) to avoid draining the battery.

When in this mode:

The steering wheel does not lock.

You cannot lock or unlock doors with the remote transmitter or the keyless access system.

Press the **ENGINE START/STOP** button three times to switch the mode to VEHICLE OFF (LOCK).

▣ ENGINE START/STOP Button

If the power mode does not change from VEHICLE OFF (LOCK) to ACCESSORY, press the **ENGINE START/STOP** button while moving the steering wheel left and right. The steering wheel will unlock, allowing the mode to change.

Do not leave the power mode in ACCESSORY or ON when you get out.

Continued

■ Power Mode Reminder

If you open the driver's door when the power mode is in ACCESSORY, a warning beep sounds.

■ Keyless Remote Reminder

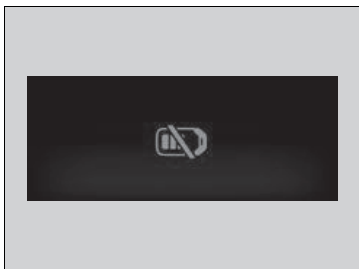

Warning buzzers may sound from inside and/or outside the vehicle to remind you that the keyless remote is out of the vehicle. If the buzzer continues even after the remote is put back inside, place it within its operational range.

■ When the power mode is in ON

If the keyless remote is taken out of the vehicle, and the driver's door is closed, a warning buzzer sounds from both inside and outside the vehicle. A warning message on the driver information interface notifies the driver inside that the remote is outside of the vehicle.

■ When the power mode is in ACCESSORY

If the keyless remote is taken out of the vehicle, and all the doors are closed, a warning buzzer sounds from outside the vehicle.

☒ Keyless Remote Reminder















When the keyless remote is within the system's operational range, and the driver's door is closed, the warning function cancels.

If the keyless remote is taken out of the vehicle after the engine has been started, you can no longer change the **ENGINE START/STOP** button mode or restart the engine. Always make sure if the remote is in your vehicle when you operate the **ENGINE START/STOP** button.

Removing the keyless remote from the vehicle through a window does not activate the warning buzzer.

Do not put the keyless remote on the dashboard or in the glove box. It may cause the warning buzzer to activate. Under some other conditions that can prevent the vehicle from locating the remote, the warning buzzer may also activate even if the remote is within the system's operational range.

Ignition Switch and Power Mode Comparison

Ignition Switch Position	LOCK  (with/without the key) 	ACCESSORY  	ON  	START  
Without Keyless Access System	<ul style="list-style-type: none"> • Engine is turned off and power is shut down. • The steering wheel is locked. • No electrical components can be used. 	<ul style="list-style-type: none"> • Engine is turned off. • Some electrical components such as the audio system and the accessory power socket can be operated. 	<ul style="list-style-type: none"> • Normal key position while driving. • All electrical components can be used. 	<ul style="list-style-type: none"> • Use this position to start the engine. • The ignition switch returns to the ON  position when you release the key.
Power Mode	VEHICLE OFF (LOCK) 	ACCESSORY 	ON   Button is: Blinking On	START 
With Keyless Access System and ENGINE START/STOP Button	Button-Off <ul style="list-style-type: none"> • Engine is turned off and power is shut down. • The steering wheel is locked. • No electrical components can be used. 	Button-Blinking <ul style="list-style-type: none"> • Engine is turned off. • Some electrical components such as the audio system and the accessory power socket can be operated. 	Button-Blinking (engine is turned off) On (engine is running) <ul style="list-style-type: none"> • All electrical components can be used. 	Button-On <ul style="list-style-type: none"> • The mode automatically returns to ON after the engine starts.

Turn Signals

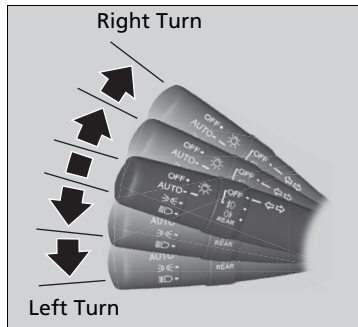

The turn signals can be used when the ignition switch is in ON **II***1.

■ One-touch turn signal

When you lightly push up or down and release the turn signal lever, the exterior turn signals and turn signal indicator blink three times. This feature can be used when signalling for a lane change.

*1: Models with the keyless access system have an **ENGINE START/STOP** button instead of an ignition switch.

Light Switches

Manual Operation

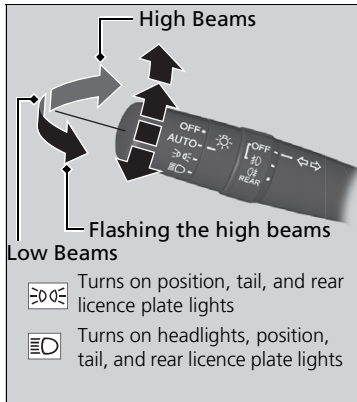

Rotating the light switch turns the lights on and off, regardless of the power mode setting or position of the ignition switch.

High beams

Push the lever forward until you hear a click.

Low beams

When in high beams, pull the lever back to return to low beams.

Flashing the high beams

Pull the lever back, and release it.

Lights off

Turn the lever to **OFF** either when:

- The shift lever is in **P**. (continuously variable transmission models)
- The parking brake is applied.

To turn the lights on again, turn the lever to **OFF** to cancel the lights off mode. Even if you do not cancel the lights off mode, the lights come on automatically when:

- The transmission is taken out of **P** (continuously variable transmission models) and the parking brake is released.
- The vehicle starts to move.

Light Switches

Models without keyless access system

If you remove the key from the ignition switch while the lights are on, a chime sounds when the driver's door is opened.

Models with keyless access system

If you leave the power mode in VEHICLE OFF (LOCK) while the lights are on, a chime sounds when the driver's door is opened.

All models

When the lights are on, the lights on indicator in the instrument panel will be on.

Indicators P. 109

Do not leave the lights on when the engine is off because it will cause the battery to discharge.

Your vehicle is equipped with the automatic headlight adjusting system that automatically adjusts the vertical angle of the low beam headlights. If you find a significant change in the vertical angle of the headlights, there may be a problem with the system. Have your vehicle checked by a dealer.

■ Automatic Operation (automatic lighting control)

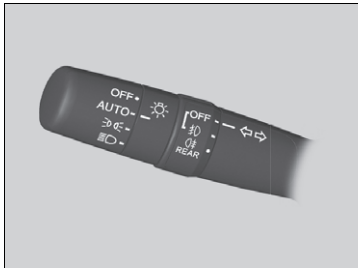

Automatic lighting control can be used when ignition switch is in ON *1.

When the light switch is in **AUTO**, the headlights and other exterior lights will switch on and off automatically depending on the ambient brightness.

The headlights come on when you unlock a door in dark areas with the headlight switch in **AUTO**.

- ▶ Once you lock the door, the headlights will go off.

*1: Models with the keyless access system have an **ENGINE START/STOP** button instead of an ignition switch.

▶▶ Automatic Operation (automatic lighting control)

We recommend that you turn on the lights manually when driving at night, in a dense fog, or in dark areas such as long tunnels or parking facilities.

The light sensor is in the location shown below. Do not cover this light sensor with anything; otherwise, the automatic lighting system may not work properly.

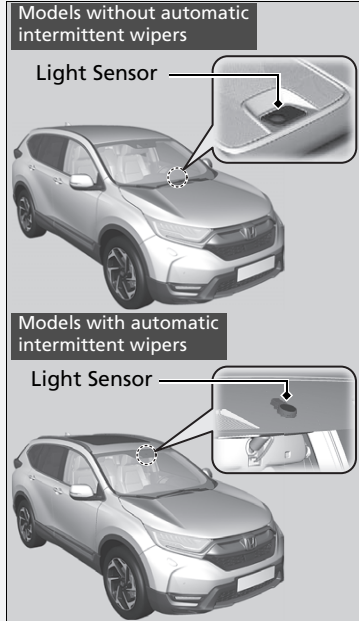

■ Headlight Integration with Wipers

The headlights automatically come on when the wipers are used several times within a certain number of intervals with the headlight switch in **AUTO**.
The headlights automatically go off a few minutes later if the wipers are stopped.

■ Automatic Lighting Off Feature

Models without keyless access system

The headlights, all other exterior lights, and the instrument panel lights turn off 15 seconds after you remove the key, and close the driver's door.

Models with keyless access system

The headlights, all other exterior lights, and the instrument panel lights turn off 15 seconds after you set the power mode to VEHICLE OFF(LOCK), take the remote with you, and close the driver's door.

All models

However, when the switch is in , the position lights remain on.

If you turn the ignition switch to LOCK *1 with the headlight switch on, but do not open the door, the lights turn off after 10 minutes (3 minutes, if the switch is in the **AUTO** position).

The lights turn on again when you unlock or open the driver's door. If you unlock the door, but do not open it within 15 seconds, the lights go off. If you open the driver's door, you will hear a lights on reminder chime.

*1: Models with the keyless access system have an **ENGINE START/STOP** button instead of an ignition switch.

⌘ Headlight Integration with Wipers

This feature activates while the headlights are off in **AUTO**. The instrument panel brightness does not change when the headlights come on.

At dark ambient light levels, the automatic lighting control feature turns on the headlights, regardless of the number of wiper sweeps.

You can turn the headlight integration with wipers function on and off.

Models with colour audio system

➤ **Customized Features** P. 158

Models with Display Audio

➤ **Customized Features** P. 413

⌘ Automatic Operation (automatic lighting control)

You can change the headlight auto off timer setting.

Models with colour audio system

➤ **Customized Features** P. 158

Models with Display Audio

➤ **Customized Features** P. 413

Active Cornering Lights*

Enhance the visibility of the corner(s) when making a turn. With the power mode in ON, the headlights on, and the vehicle speed at less than 40 km/h (25 mph), the cornering light(s) comes on either when operating the turn signals or the steering wheel, or moving the shift lever to **R**.

■ **The corner where you are making a turn is illuminated when:**

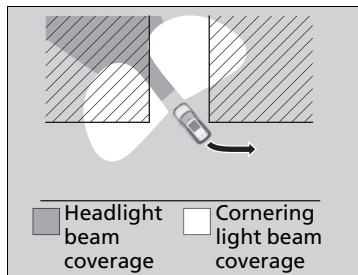
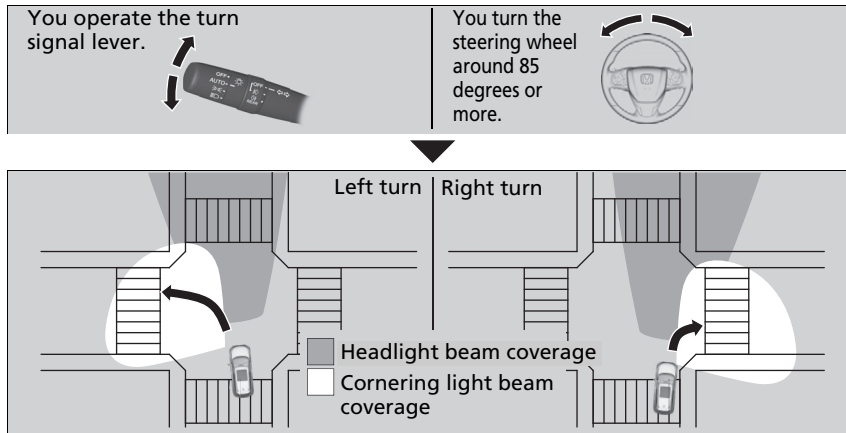

▶ Active Cornering Lights*

The active cornering lights go off automatically after five minutes. To resume the lights on, recreate the same condition; putting the turn signal lever or steering wheel in the centre position, then operate it again, or if the shift lever has been in **R**, move it to another position momentarily.

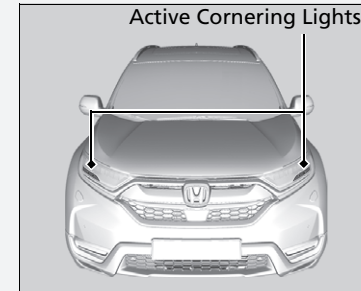

Fog Lights

■ Front fog lights*

Can be used when the position lights or the headlights are on.

Can be used when the headlights are on.



■ Rear fog light

Can be used when the headlights or the front fog lights are on.

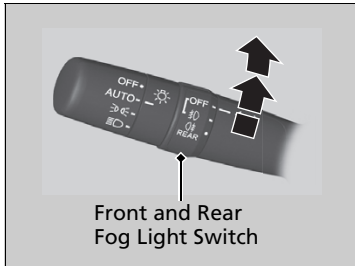

■ Front and Rear Fog Lights*





■ To turn the front fog lights on

Rotate the switch up from the **OFF** position to the  position. The  indicator comes on.

■ To turn the front and rear fog lights on

Rotate the switch one position up from the  position. The  and  indicators come on.

■ To turn the rear fog light on

Rotate the switch one position up from the  position and then rotate the switch one position down from the  position. The  indicator stays on.

To turn the rear fog light off, turn the headlight switch to the **OFF** position.

■ Rear Fog Light*



■ To turn the rear fog light on

Rotate the switch to ☁. The ☁ indicator comes on.

Auto High-Beam (High Beam Support System)

Using a camera mounted to the inside of the windscreen, this system detects light sources ahead of the vehicle. Depending on the light source, the system automatically switches the headlights to high beam for optimal visibility at night.

The system operates when:

- The headlight switch is in **AUTO**.
- The lever is in the low beam position.
- The low beams are on and the system recognises that you are driving at night.
- The vehicle speed is above 40 km/h (25 mph).

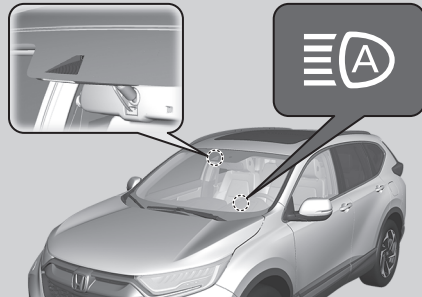

How it works

When the camera detects lights coming from a preceding or oncoming vehicle, the headlights remain in low beam.

When the camera detects no lights coming from a preceding or oncoming vehicle, the headlights change to high beam.

The view angle or distance that the camera can detect lights ahead differs depending on conditions, such as the brightness of the lights and the weather.

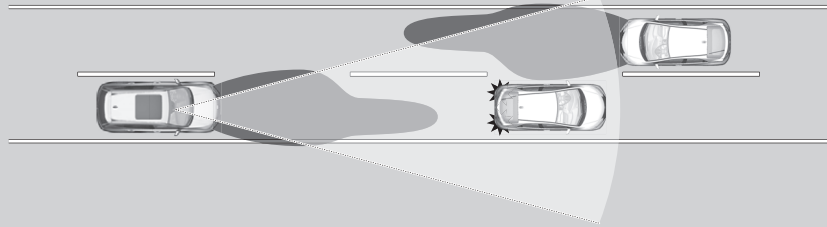

Auto High-Beam (High Beam Support System)

The auto high-beam determines when to change the headlight beams by responding to the brightness of the lights ahead of your vehicle. In the following cases, the system may not respond to the lights properly:

- The brightness of the lights from the preceding or oncoming vehicle is intense or poor.
- Visibility is poor due to the weather (rain, snow, fog, windscreen frost, etc.).
- Other light sources, such as streetlights and electric billboards are illuminating the road ahead.
- The brightness level of the road ahead constantly changes.
- The road is bumpy or with many curves.
- A vehicle cuts in front of you, or a vehicle in front of you is not in the preceding or oncoming direction.
- Your vehicle is tilted with a heavy load in the rear.

If you find the timing of beam changes inconvenient for driving, change the headlight beams manually.

If you do not want the system to be activated at any time when the headlight switch is in **AUTO**, consult a dealer.

■ Operating the System

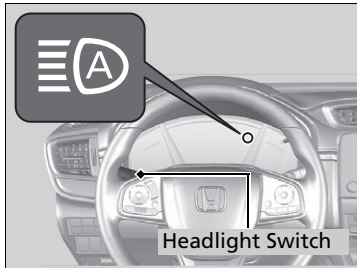

To activate the system, turn the headlight switch to **AUTO** and then set the headlights to low beam. The auto high-beam indicator will come on.

➤ **Light Switches** P. 223

The high beams remain on unless:

- You have been driving below 24 km/h (15 mph) for an extended amount of time.
- The speed of the vehicle drops below 10 km/h (6 mph).
- The windscreen wipers have been running at a high speed for more than a few seconds.
- You enter a well lit location.

If needed, you can temporarily turn the system off manually. Turn on the high beams by pushing the lever forward until you hear a click, or flash the high beams once by pulling the lever toward you. To turn the system back on, pull and hold the lever towards you for a few seconds.

⌘ Operating the System

For the auto high-beam to work properly:

- Do not place an object that reflects light on the dashboard.
- Keep the windscreen around the camera clean.
- Do not attach an object, sticker or film to the area around the camera.

If the camera receives a strong impact, or repairing of the area near the camera is required, consult a dealer.

If the  message appears:

- Use the climate control system to cool down the interior and, if necessary, also use demister mode with the airflow directed towards the camera.
- Start driving the vehicle to lower the windscreen temperature, which cools down the area around the camera.

If the  message appears:

- Park your vehicle in a safe place, and clean the windscreen. If the message does not disappear after you have cleaned the windscreen and driven for a while, have your vehicle checked by a dealer.

Disabling or Re-enabling the System

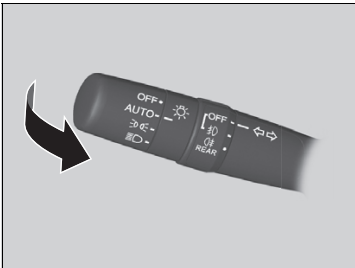

Disable or re-enable the system when the vehicle is parked and the ignition switch in ON **II***1 and the light switch is in the **AUTO** position.

Disabling the system: Pull the light switch lever toward you and hold it for at least 40 seconds. The auto high-beam indicator in the meter will blink twice.

Re-enabling the system: Pull the light switch lever toward you and hold it for at least 30 seconds. The auto high-beam indicator in the meter will blink once.

Disabling or Re-enabling the System

The auto high-beam is in the previously selected disabled or re-enabled setting each time you start the engine.

* 1: Models with the keyless access system have an **ENGINE START/STOP** button instead of an ignition switch.

Daytime Running Lights

The position/daytime running lights come on when the following conditions have been met:

- The ignition switch in ON *1
- The headlight switch is **AUTO** or **OFF**.

The daytime running lights are off once the headlight switch is turned on, or when the headlight switch is in **AUTO** and it is getting darker outside.

Turning off the ignition switch*1 will turn off the daytime running lights.

*1: Models with the keyless access system have an **ENGINE START/STOP** button instead of an ignition switch.

Wipers and Washers

■ Windscreen Wipers/Washers

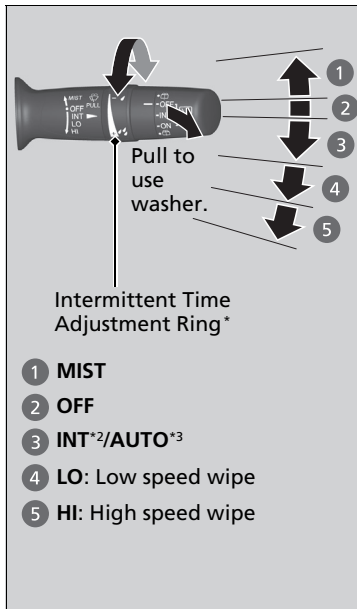

- 1 MIST
- 2 OFF
- 3 INT*2/AUTO*3
- 4 LO: Low speed wipe
- 5 HI: High speed wipe

The windscreen wipers and washers can be used when the ignition switch is in ON **II***1.

■ MIST

The wipers run at high speed until you release the lever.

■ Wiper switch (OFF, INT*2/AUTO*3, LO, HI)

Change the wiper switch setting according to the amount of rain.

■ Adjusting wiper operation

Turn the adjustment ring to adjust the wiper operation.

- Lower speed, fewer sweeps
- + Higher speed, more sweeps

■ Washer

Sprays while you pull the lever towards you. When you release the lever for more than one second, the spray stops, the wipers sweep two or three more times to clear the windscreen, then stop.

*1: Models with the keyless access system have an **ENGINE START/STOP** button instead of an ignition switch.

*2: Models with manual intermittent operation

*3: Models with automatic intermittent operation

* Not available on all models

⊠ Wipers and Washers

NOTICE

Do not use the wipers when the windscreen is dry. The windscreen will get scratched, or the rubber blades will get damaged.

NOTICE

In cold weather, the blades may freeze to the windscreen. Operating the wipers in this condition may damage the wipers. Use the demister to warm the windscreen, then turn the wipers on.

NOTICE

Turn the washers off if no washer fluid comes out. The pump may get damaged.

Models with intermittent time adjustment ring

If the vehicle speeds up while the wipers are operating intermittently, the length of the wipe interval shortens. When the vehicle speeds up, the wiper operation's shortest delay setting (⏸) and the **LO** setting become the same.

If the wiper stops operating due to an obstacle such as the build-up of snow, park the vehicle in a safe place. Rotate the wiper switch to **OFF**, and turn the ignition switch to ACCESSORY **I** or LOCK **0***1, then remove the obstacle.

■ Automatic Intermittent Wipers*

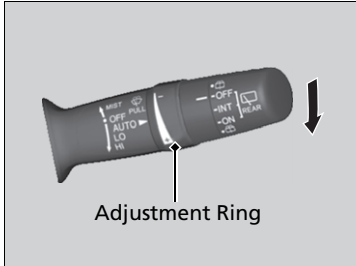

When you push the lever down to **AUTO**, the windscreen wipers sweep once, and go into the automatic mode.

The wipers operate intermittently, at low speed, or at high speed and stops in accordance with the amount of rainfall the rainfall sensor detects.

■ AUTO sensitivity adjustment

When the wiper function is set to **AUTO**, you can adjust the sensitivity of the rain fall sensor (using the adjustment ring) so that wipers will operate in accordance with your preference.

Sensor sensitivity

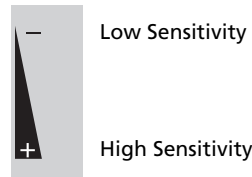

▶ Wipers and Washers

The wiper motor may stop motor operation temporarily to prevent an overload. Wiper operation will return to normal within a few minutes, once the circuit has returned to normal.

▶ Automatic Intermittent Wipers*

The rainfall sensor is in the location shown below.

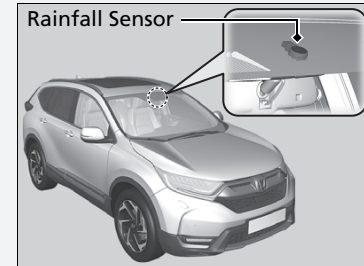



NOTICE

AUTO should always be turned **OFF** before the following situation in order to prevent severe damage to the wiper system:

- Cleaning the windscreen
- Driving through a car wash
- No rain present

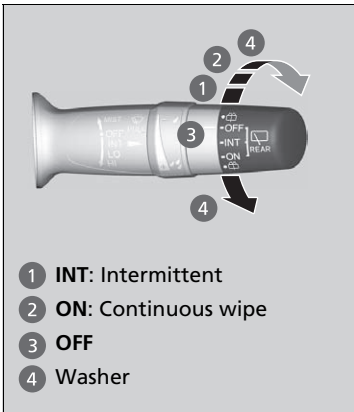
■ Rear Wiper/Washer



The rear wiper and washer can be used when the ignition switch is in ON *1.

■ Wiper switch (OFF, INT, ON)

Change the wiper switch setting according to the amount of rain.

■ Washer

Sprays while you rotate the switch to this position. Hold it to activate the wiper and to spray the washer. Once released, it stops operating after a few more sweeps.

■ Operating in reverse

When you shift the transmission to  with the windscreen wipers activated, the rear wiper operates automatically as follows even if its switch is off.

Front Wiper Position	Rear Wiper Operation
INT* (Intermittent) AUTO* (Intermittent)	Intermittent
LO (Low speed wipe) HI (High speed wipe)	Continuous

*1: Models with the keyless access system have an **ENGINE START/STOP** button instead of an ignition switch.

* Not available on all models

■ Headlight Washers*

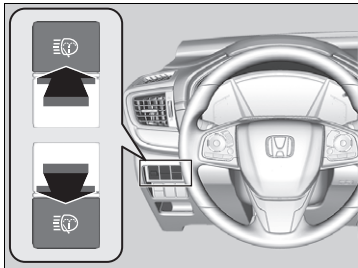

Turn the headlights on and press the headlight washer button to operate. The headlight washers also operate when you turn the windscreen washers for the first time after the ignition switch is in ON *1.

▣ Headlight Washers*

The headlight washers use the same fluid reservoir as the windscreen washers.

*1: Models with the keyless access system have an **ENGINE START/STOP** button instead of an ignition switch.

* Not available on all models

Brightness Control

■ Adjusting the Instrument Panel Brightness

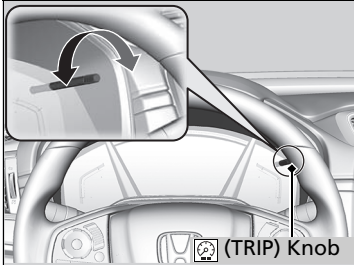

When the surroundings are dark and the ignition switch is in ON **II***1, you can use the  (TRIP) knob to adjust instrument panel brightness.

Brighten: Turn the knob to the right.

Dim: Turn the knob to the left.

Several seconds after you have adjusted the brightness, you will be returned to the previous screen.

■ Brightness level indicator

The brightness level is shown on the display while you are adjusting it.

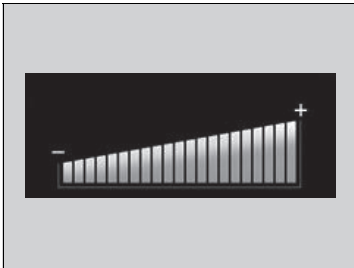

☒ Brightness Control

Instrument panel brightness varies, depending on whether the exterior lights are on or off. The instrument panel dims to reduce glare when they are on.

To cancel the reduced instrument panel brightness when the exterior lights are on, turn the knob to the right until the brightness display is up to max.

The brightness can be set differently for when the exterior lights are on, and when they are off.

*1: Models with the keyless access system have an **ENGINE START/STOP** button instead of an ignition switch.

■ Adjusting the Head-up Display Brightness*

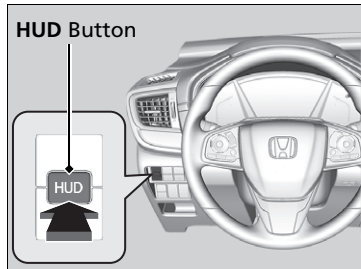

You can operate the head-up display to press the **HUD** button for about one second when the power mode is in ON.

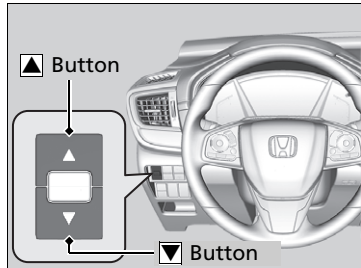

When the head-up display is on, press and hold the **HUD** button until its brightness level indicator on the driver information interface.

Brighten: Press the ▲ button.

Dim: Press the ▼ button.

The driver information interface will return to its original state several seconds after you adjust the brightness.

▶▶ Adjusting the Head-up Display Brightness*

The brightness can be set differently for when the exterior lights are on, and when they are off.

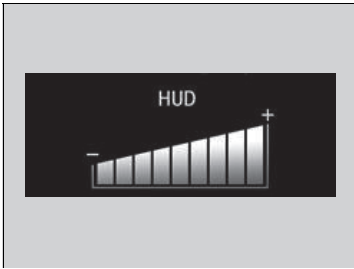

■ **Brightness level indicator**

The brightness level is shown on the driver information interface while you are adjusting it.

Rear Demister/Heated Door Mirror Button

Press the rear demister and heated door mirror button to defog the rear window and mirrors when the ignition switch is in ON *1.

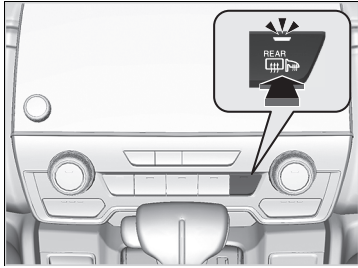

The rear demister and heated door mirror automatically switches off after 10-30 minutes depending on the outside temperature. However, if the outside temperature is 0°C or below, it does not automatically switch off.

Rear Demister/Heated Door Mirror Button

This system consumes a lot of power, so turn it off when the window has been demister or deiced. Also, do not use the system for a long time while the engine is idling. This may weaken the battery, making it difficult to start the engine.

When the outside temperature is below 5°C, the heated door mirror may activate automatically for 10 minutes when you turn the ignition switch to ON *1.

*1: Models with the keyless access system have an **ENGINE START/STOP** button instead of an ignition switch.

Heated Windscreen Button *

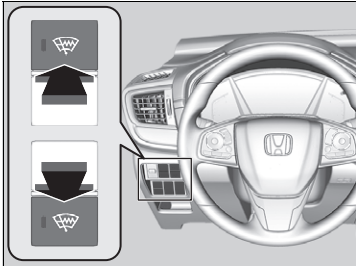

Press the heated windscreen button to deice the windscreen when the ignition switch is in ON *1.

Heated Windscreen Button *

This system consumes a lot of power, so turn it off when the window has been deiced. Also, do not use the system for a long period when the engine is idling. This may weaken the battery, making it difficult to start the engine.

*1: Models with the keyless access system have an **ENGINE START/STOP** button instead of an ignition switch.

* Not available on all models

Driving Position Memory System*

You can store two driver's seat positions (except for power lumbar) with the driving position memory system.

When you unlock and open the driver's door with a remote transmitter or the keyless access system, the seat adjusts automatically to one of the two preset positions.

- **DRIVER 1** transmitter is linked to memory button 1.
- **DRIVER 2** transmitter is linked to memory button 2.



▶▶ Driving Position Memory System*

Using the audio/information screen, you can disable the automatic seat adjustment function.

▶ **Customized Features** P. 405

System Operation

The system will not operate if:

- Either seat position button is pressed while the seat is in motion.
- Either memory position button is pressed while the seat is in motion.
- The vehicle speed is above 3 km/h (2 mph).
- Overload to the seat motor.

Storing a Position in Memory

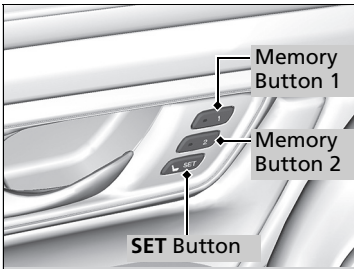

1. Set the power mode to ON. Adjust the driver's seat to the desired position.
2. Press the **SET** button.
 - ▶ The memory button indicator light will blink.
3. Press and hold memory button **1** or **2** within five seconds of pressing the **SET** button.
 - ▶ Once the seat position has been memorized, the indicator light on the button you pressed stays on.

Recalling the Stored Position

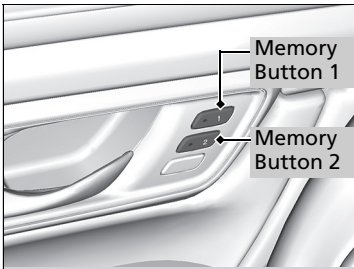

Continuously variable transmission models

1. Put the transmission into **P**.
2. Press a memory button (**1** or **2**).
 - ▶ The indicator light will blink.

Manual transmission models

1. Apply the parking brake.
2. Press a memory button (**1** or **2**).
 - ▶ The indicator light will blink.

The seat will automatically move to the memorized position. When it has finished moving, the indicator light stays on.

Storing a Position in Memory

After you press the **SET** button, the storing operation will be cancelled when:

- You do not press the memory button within five seconds.
- You readjust the seat position before the double-beep.
- You set the power mode to any position except ON.

Recalling the Stored Position

The seat will stop moving if you:

- Press the **SET** button, or a memory button (**1** or **2**).
- Adjust the seat position.
- Put the transmission into a position other than **P** (continuously variable transmission).
- Release the parking brake (manual transmission).

Adjusting the Steering Wheel

The steering wheel height and distance from your body can be adjusted so that you can comfortably grip the steering wheel in an appropriate driving posture.

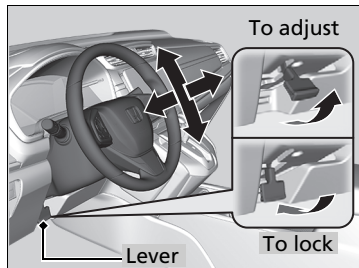

1. Pull the steering wheel adjustment lever up.
 - ▶ The steering wheel adjustment lever is under the steering column.
2. Move the steering wheel up or down, and in or out.
 - ▶ Make sure you can see the instrument panel gauges and indicators.
3. Push the steering wheel adjustment lever down to lock the steering wheel in position.
 - ▶ After adjusting the position, make sure you have securely locked the steering wheel in place by trying to move it up, down, in, and out.

Adjusting the Steering Wheel

⚠ WARNING

Adjusting the steering wheel position while driving may cause you to lose control of the vehicle and be seriously injured in a crash.

Adjust the steering wheel only when the vehicle is stopped.

Interior Rearview Mirror

Adjust the angle of the rearview mirror when you are sitting in the correct driving position.

Rearview Mirror with Day and Night Positions*

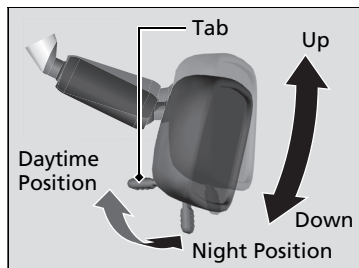

Flip the tab to switch the position. The night position will help to reduce the glare from headlights behind you when driving after dark.

Automatic Dimming Rearview Mirror*

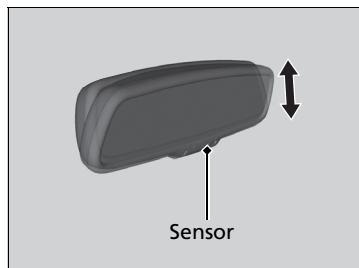

When you are driving after dark, the automatic dimming rearview mirror reduces the glare from headlights behind you, based in inputs from the mirror sensor. This feature is always active.

Adjusting the Mirrors

Keep the inside and outside mirrors clean and adjusted for best visibility.

Adjust the mirrors before you start driving.

➤ **Front Seats** P. 249

Automatic Dimming Rearview Mirror*

The auto dimming function cancels when the transmission is in **R**.

* Not available on all models

Power Door Mirrors

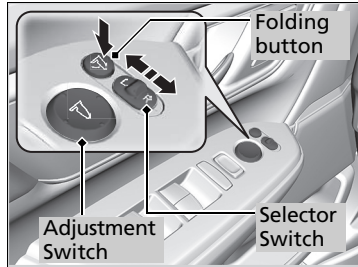

You can adjust the door mirrors when the ignition switch is in ON *1.

■ Mirror position adjustment

L/R selector switch: Select the left or right mirror. After adjusting the mirror, return the switch to the centre position.

Mirror position adjustment switch: Press the switch left, right, up, or down to move the mirror.

■ Folding door mirrors

Press the folding button to fold in and out the door mirrors.

*1: Models with the keyless access system have an **ENGINE START/STOP** button instead of an ignition switch.

Reverse Tilt Door Mirror*

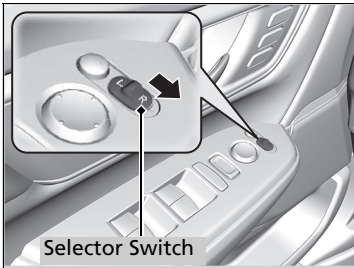

If activated, the passenger side door mirror automatically tilts downward when you put the transmission into **R**; this improves close-in visibility on the passenger side of the vehicle when backing up. The mirror automatically returns to its original position when you take the transmission out of **R**.

To activate this feature, set the ignition switch is in ON **II***1, and slide the selector switch to the passenger's side.

*1: Models with the keyless access system have an **ENGINE START/STOP** button instead of an ignition switch.

* Not available on all models

Continued

■ Automatic Folding Door Mirror Function *

■ Folding in the door mirrors

Press the lock button on the remote transmitter twice within 10 seconds, and hold it.

- ▶ You can release the button once the mirrors start folding in automatically.

Models with keyless access system

Touch the door lock button on either front door or the tailgate twice within 10 seconds.

- ▶ The mirrors start folding in automatically.

■ Folding out the door mirrors

Unlock all doors and the tailgate using the remote transmitter. Open the driver's door.

- ▶ The mirrors start folding out automatically.

Models with keyless access system

Grab the door handle on either front door and unlock all doors. Open the driver's door.

- ▶ The mirrors start folding out automatically.

⌘ Automatic Folding Door Mirror Function *

You cannot turn the automatic folding out automatically if they have been folded in using the folding button.

Door mirrors will not fold automatically when locking from inside the vehicle using lock tab or master door lock switch.

Adjusting the Seats

Front Seats

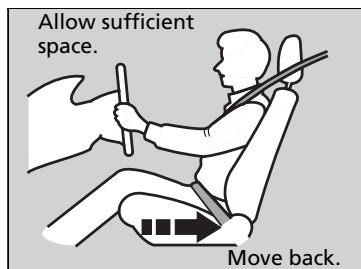

Adjust the driver's seat as far back as possible while allowing you to maintain full control of the vehicle. You should be able to sit upright, well back in the seat and be able to adequately press the pedals without leaning forward, and grip the steering wheel comfortably. The passenger's seat should be adjusted in a similar manner, so that it is as far back from the front airbag in the dashboard as possible.

Adjusting the Seats

WARNING

Sitting too close to a front airbag can result in serious injury or death if the front airbags inflate.

Always sit as far back from the front airbags as possible while maintaining control of the vehicle.

In addition to the seat adjustment, you can adjust the steering wheel up and down, in and out. Allow at least 25 cm between the centre of the steering wheel and the chest.

Always make seat adjustments before driving.

Adjusting the Seat Positions

Adjusting the front power seat*

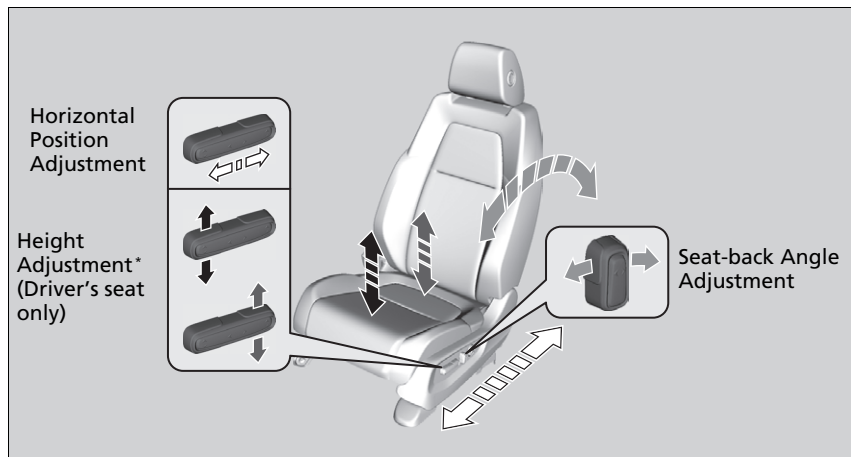

* Not available on all models

Continued

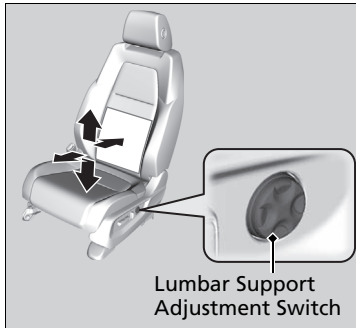

■ **Lumbar Support Adjustment Switch***

Press the top: To increase the higher part of the lumbar support.

Press the bottom: To increase the lower part of the lumbar support. (The higher part support is decreased.)

Press the front: To increase the entire lumbar support.

Press the rear: To decrease the entire lumbar support.

■ Adjusting the front manual seat(s)*

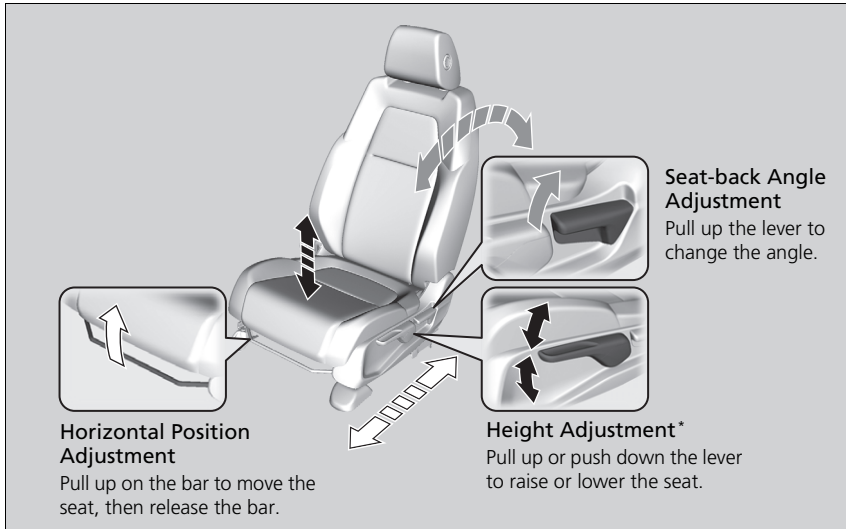

▣ Adjusting the front manual seat(s)*

Once a seat is adjusted correctly, rock it back and forth to make sure it is locked in position.

* Not available on all models

Continued

■ Adjusting the Seat-Backs

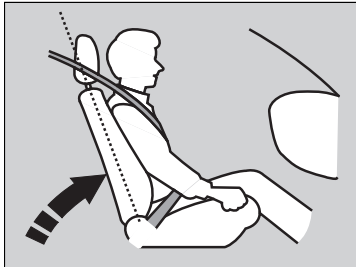

Adjust the driver's seat-back to a comfortable, upright position, leaving ample space between your chest and the airbag cover in the centre of the steering wheel.

The front seat passenger should also adjust their seat-back to a comfortable, upright position.

Reclining a seat-back so that the shoulder part of the belt no longer rests against the occupant's chest reduces the protective capability of the belt. It also increases the chance of sliding under the belt in a crash and being seriously injured. The farther a seat-back is reclined, the greater the risk of injury.

► Adjusting the Seat-Backs

⚠ WARNING

Reclining the seat-back too far can result in serious injury or death in a crash.

Adjust the seat-back to an upright position, and sit well back in the seat.

Do not put a cushion, or other object, between the seat-back and your back.

Doing so may interfere with proper seat belt or airbag operation.

If you cannot get far enough away from the steering wheel and still reach the controls, we recommend that you investigate whether some type of adaptive equipment may help.

Second Row Seats

■ Adjusting the Seat Positions

Models without third row seat

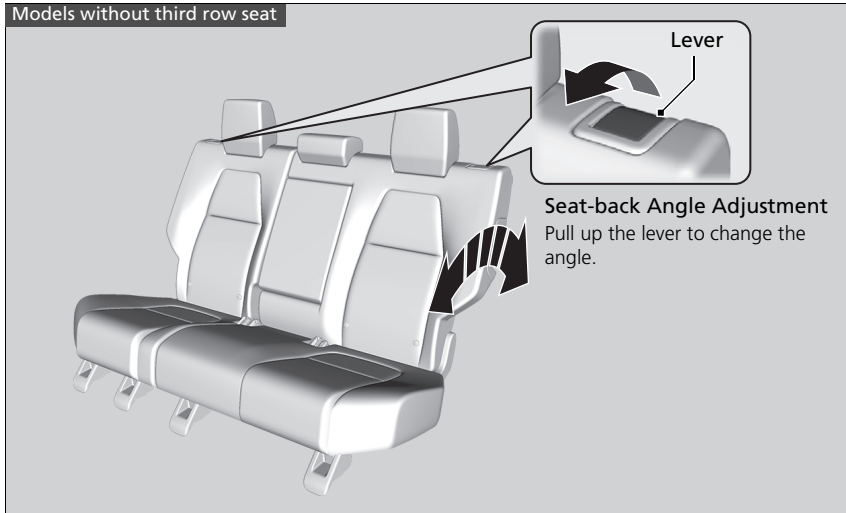

▣ Second Row Seats

Once a seat is adjusted correctly, rock it back and forth to make sure it is locked in position.

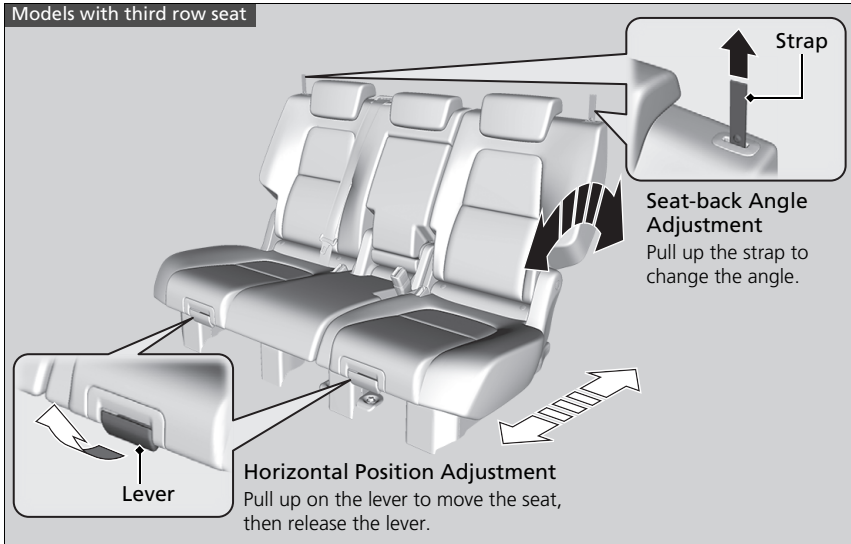

Models without third row seat

Folding Down the Second Row Seats

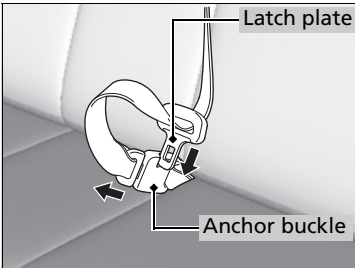

1. Store the centre seat belt first. Insert the latch plate into the slot on the side of the anchor buckle.
2. Retract the seat belt into the holder on the ceiling.
 - **Seat Belt with Detachable Anchor***
P. 51
3. Lower the second row seat head restraint to its lowest position. Put the armrest back into the seat-back.

From the second row seat side

4. Pull the release lever and fold down the seat.

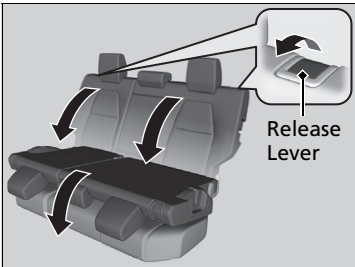

▶▶ Folding Down the Second Row Seats

⚠ WARNING

Make sure the seat-backs are latched securely before driving.

The rear seat-backs can be folded down to accommodate bulkier items in the luggage area.

Never drive with the seat-back folded down and the tailgate open.

➤ **Exhaust Gas Hazard** P. 94

When returning the seat-back to its original position, push it firmly back. Also, make sure all rear shoulder belts are positioned in front of the seat-back.

Make sure all items in the luggage area or items extending through the opening into the rear seats are properly secured. Loose items can fly forward if you have to brake hard.

* Not available on all models

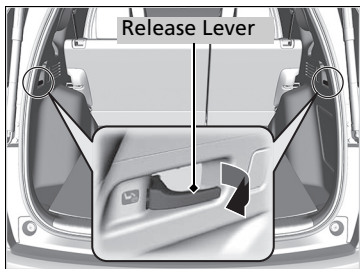

From the luggage area side

4. Pull the release lever and fold down the seat.

Models with third row seat

Folding Down the Second Row Seats

Separately fold down the left and right halves of the second row seat to make room for luggage.

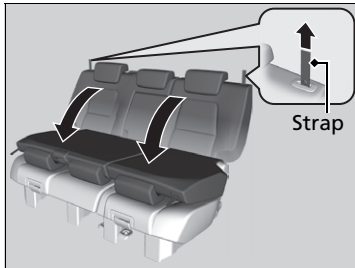

1. Lower the centre head restraint to its lowest position. Put the armrest back into the seat-back.
2. Pull up on the seat-back angle adjustment strap.

To return the seat to the original position, pull up the seat-back in the upright position.

Folding Down the Second Row Seats

The front seats must be far enough forward so they do not interfere with the second row seats as they fold down.

To lock the seat-back upright, push it backwards until it locks.

Make sure the seat-back, head restraints and seat cushion are securely latched back into place before driving. Also, make sure all rear shoulder belts are positioned in front of the seat-back, and the centre shoulder belt is re-positioned in the holding slot.

Models with third row seat

Third Row Seat Access

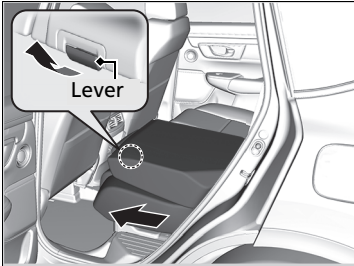
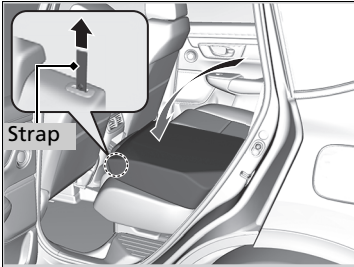

1. Lower the second row seat head restraint to its lowest position.
2. Pull up the strap that is located at the shoulder of the seat, and fold down the seat-back.
3. While pulling the lever, move the entire seat forward.

Third Row Seat Access

When you enter the third row seat, be careful not to trip over the second row seat belt.

The front seats must be far enough forward so they do not interfere with the second row seats as they fold down.

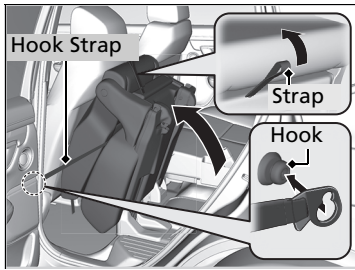

4. Lift up the entire seat while pulling up the strap on the seat.
5. Hang the hook strap that is located next to the seat to the pillar, and fix it.

Third Row Seats*

■ Adjusting the Seat Positions

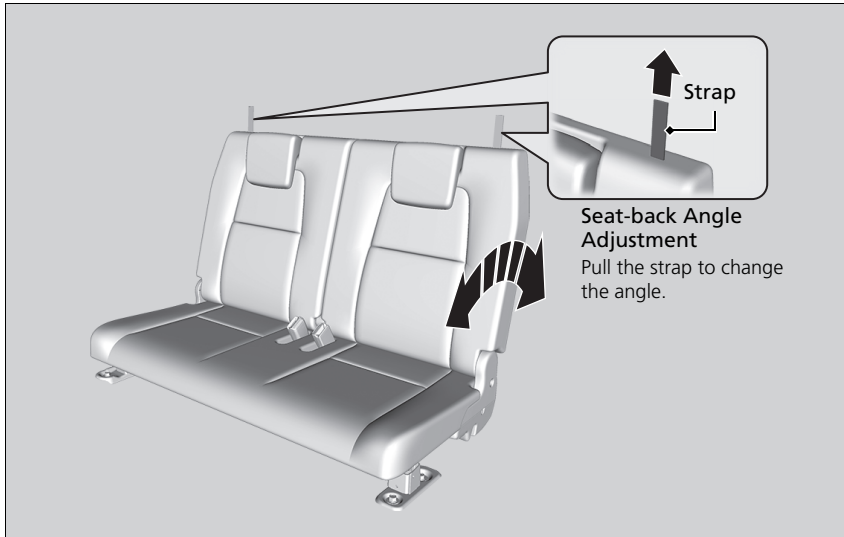

▶▶ Third Row Seats*

Once a seat is adjusted correctly, rock it back and forth to make sure it is locked in position.

Models with third row seat

Folding Down the Third Row Seat

Separately fold down the left and right halves of the third row seat to make room for luggage.

To fold down the seat

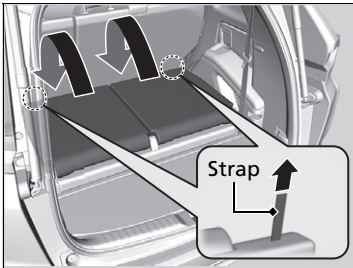

1. Lower the third row seat head restraint to its lowest position.
 2. Pull the strap on the seat-back fully.
 3. Push the seat-back forward while pulling the strap.
- ▶ If you want to use the luggage area flatly, put the floor lid in the upper position.
- 📦 **Luggage Storage Area** P. 275

To return the seat to the original position

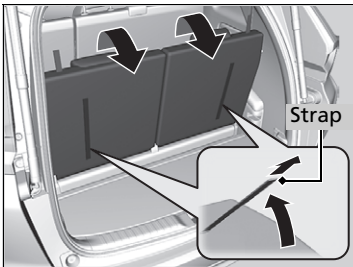

1. Pull the seat-back up with the strap pulled.
2. Pull the head restraint up to its original position.

Folding Down the Third Row Seat

Make sure all items in the luggage area or items extending to the third row seats are properly secured. Loose items can fly forward if you have to brake hard.

To return the seat to the original position

Make sure the seat-back and head restraints are securely latched back into place before driving.

Head Restraints

Your vehicle is equipped with head restraints in all seating positions.

■ Adjusting the Front Head Restraints

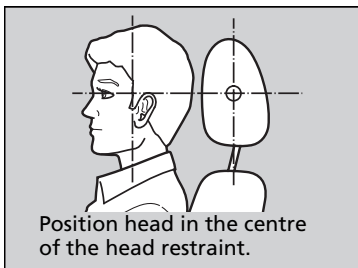

Head restraints are most effective for protection against whiplash and other rear-impact crash injuries when the centre of the back of the occupant's head rests against the centre of the restraint. The tops of the occupant's ears should be level with the centre height of the restraint.

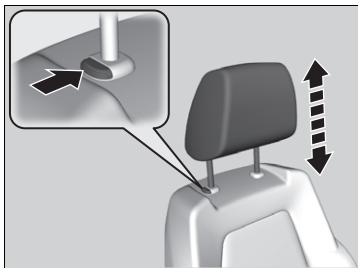

To raise the head restraint: Pull it upward.

To lower the head restraint: Push it down while pressing the release button.

► Adjusting the Front Head Restraints

⚠ WARNING

Improperly positioning head restraints reduces their effectiveness and increases the likelihood of serious injury in a crash.

Make sure head restraints are in place and positioned properly before driving.

In order for the head restraint system to work properly:

- Do not hang any items on the head restraints, or from the restraint legs.
- Do not place any objects between an occupant and the seat-back.
- Install each restraint in its proper location.

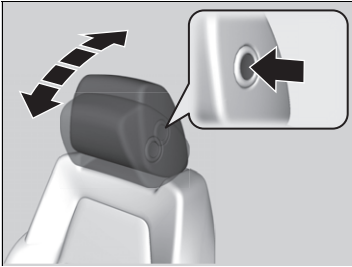

To tilt the head restraint forward:

Push the back of it forward.

To tilt the head restraint backward:

Push it backward while pressing the release button on the side of the head restraint.

Models without third row seat

Changing the Second Row Seat Head Restraint Position

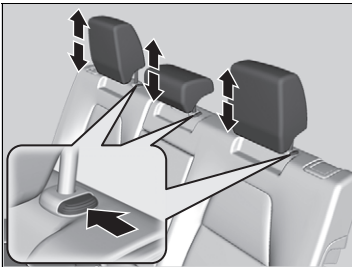

A passenger sitting in the second row seat seating position should adjust the height of their head restraint to an appropriate position before the vehicle begins moving.

To raise the head restraint:

Pull it upward.

To lower the head restraint:

Push it down while pressing the release button.

Changing the Second Row Seat Head Restraint Position

When you use the head restraint in the second row centre seating position, pull up the head restraint to its highest position. Do not use it in any lower position.

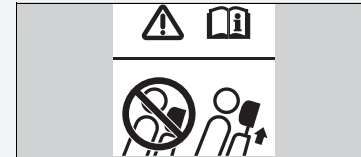

Models with third row seat

Changing the Second Row and Third Row Seat Head Restraint Position

Second row seat

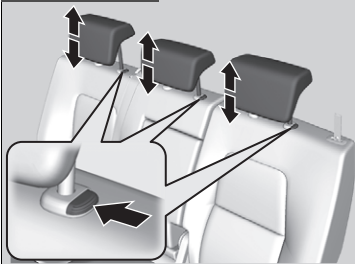

A passenger sitting in the second row and third row seating position should adjust the height of their head restraint to an appropriate position before the vehicle begins moving.

To raise the head restraint:

Pull it upward.

To lower the head restraint:

Push it down while pressing the release button(s).

Third row seat

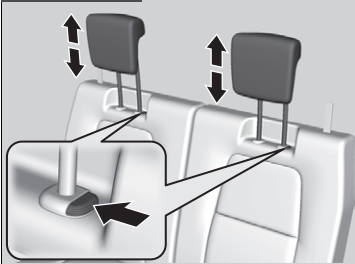

Changing the Second Row and Third Row Seat Head Restraint Position

When you use the head restraint in the second row and third row seating position, pull up the head restraint to its highest position. Do not use it in any lower position.

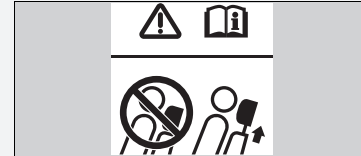

■ Removing and Reinstalling the Head Restraints

Head restraints can be removed for cleaning or repair.

To remove a head restraint:

Pull the restraint up as far as it will go. Then push the release button, and pull the restraint up and out.

To reinstall a head restraint:

Insert the legs back in place, then adjust the head restraint to an appropriate height while pressing the release button. Pull up on the restraint to make sure it is locked in position.

⌘ Removing and Reinstalling the Head Restraints

⚠ WARNING

Failure to reinstall, or correctly reinstall, the head restraints can result in severe injury during a crash.

Always replace the head restraints before driving.

Maintain a Proper Sitting Position

After all occupants have adjusted their seats and head restraints, and put on their seat belts, it is very important that they continue to sit upright, well back in their seats, with their feet on the floor, until the vehicle is safely parked and the engine is off.

Sitting improperly can increase the chance of injury during a crash. For example, if an occupant slouches, lies down, turns sideways, sits forward, leans forward or sideways, or puts one or both feet up, the chance of injury during a crash is greatly increased.

In addition, an occupant who is out of position in the front seat can be seriously or fatally injured in a crash by striking interior parts of the vehicle or being struck by an inflating front airbag.

ⓘ Maintain a Proper Sitting Position

WARNING

Sitting improperly or out of position can result in serious injury or death in a crash.

Always sit upright, well back in the seat, with your feet on the floor.

Armrest

■ Using the Front Seat Armrest

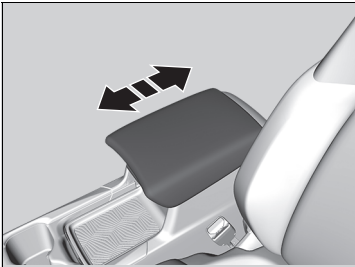

The console lid can be used as an armrest.

To adjust:

Slide the armrest to a desired position.

■ Using the Second Row Seat Armrest



Pull down the armrest in the centre seat-back.

Interior Lights

Interior Light Switches

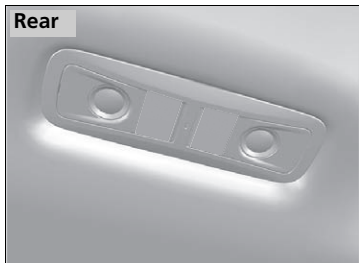
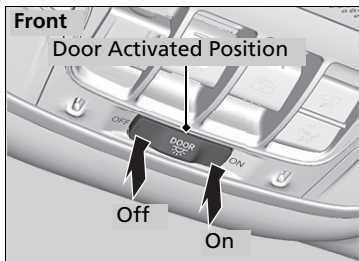

■ ON

The interior lights come on regardless of whether the doors are open or closed.

■ Door activated

The interior lights come on in the following situations:

- When any doors are opened.
- You unlock the driver's door.

Models without keyless access system

- You remove the key from the ignition switch.

Models with keyless access system

- When the power mode is set to VEHICLE OFF (LOCK).

■ OFF

The interior lights remain off regardless of whether the doors are open or closed.

Interior Light Switches

In the door activated position, the interior lights fade out and go off about 30 seconds after the doors are closed.

The lights go off after about 30 seconds in the following situations:

- When you unlock the driver's door but do not open it.

Models without keyless access system

- When you remove the key from the ignition switch but do not open a door.

Models with keyless access system

- When you set the power mode to VEHICLE OFF (LOCK) but do not open a door.

You can change the interior lights dimming time.

Models with colour audio system

➔ **Customized Features** P. 158

Models with Display Audio

➔ **Customized Features** P. 413

The interior lights go off immediately in the following situations:

- When you lock the driver's door.

Models without keyless access system

- When you close the driver's door with the key in the ignition switch.

Models with keyless access system

- When you close the driver's door in ACCESSORY mode.
- When you set the power mode to ON.

☒ Interior Light Switches

To avoid draining the battery, do not leave the interior light on for an extended length of time when the engine is off.

If you leave any of the doors open in VEHICLE OFF (LOCK) mode, or without the key in the ignition switch, the interior lights go off after about 15 minutes.

■ Map Lights

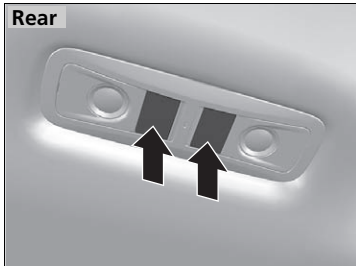

■ Front seat

The map lights can be turned on and off by pressing the  (map light) button.

■ Second row seat

The map lights can be turned on and off by pressing the  (map light) button.

» Map Lights

Models with Panoramic Roof

When the interior light switch is in the door activated position and a door is opened or interior light switch is in the **ON** position, the rear map light will not go off when you press the  (map light) button.

■ Luggage Area Lights

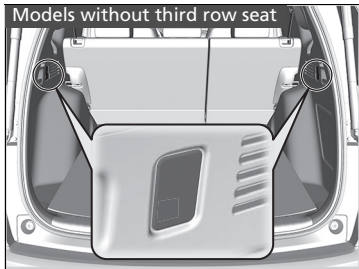

The lights come on when you open the tailgate.

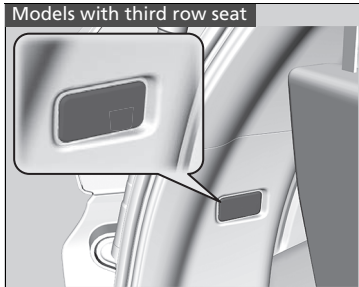

Interior Convenience Items

■ Glove Box

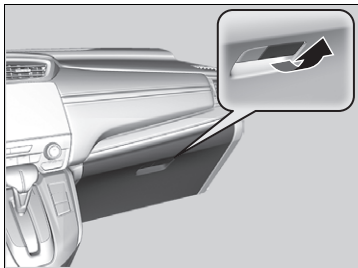

Pull the handle to open the glove box.

» Glove Box

⚠ WARNING

An open glove box can cause serious injury to your passenger in a crash, even if the passenger is wearing the seat belt.

Always keep the glove box closed while driving.

■ Centre Console Box

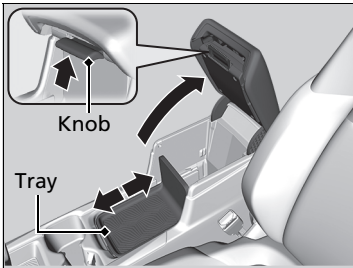

To open, pull the knob. You can change the position of the tray by sliding it forward or back.

■ Removing the tray

1. Slide the tray back.

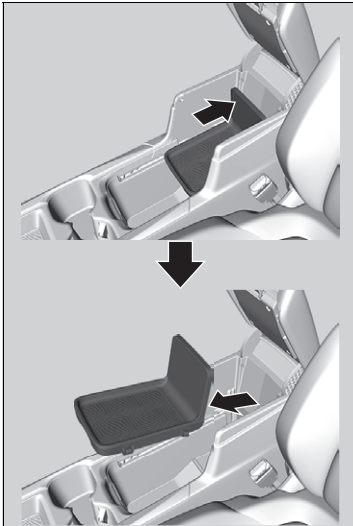

2. Lift the edge of the tray up slightly, then pull it out.

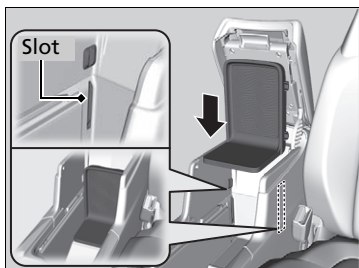

Storing the tray:

Line the tray up with the slots located at the rear section of the console box, and then push it down all the way until it is in the locked position.

■ Luggage Storage Area

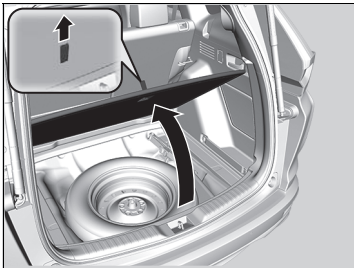

Models without third row seat

■ When putting the floor lid in the bottom position

This is convenient when storing a tall item.

1. Pull the strap to open the luggage floor lid.

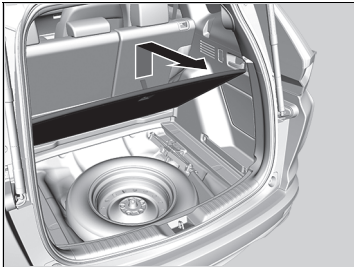

2. Pull the strap upwards to lift the floor lid.

3. Pull the floor lid towards you until it disengages from the support rods.

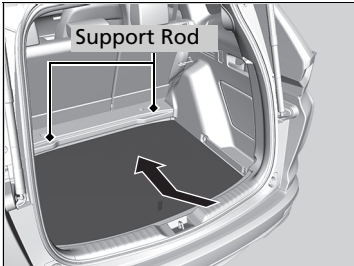

4. Push the far end of the floor lid down to the bottom under the support rod, then lower the other end.

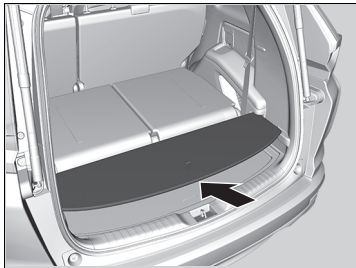
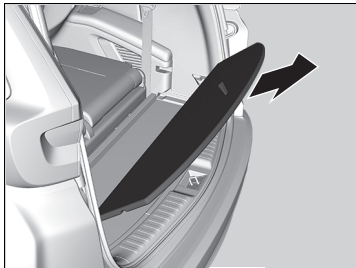
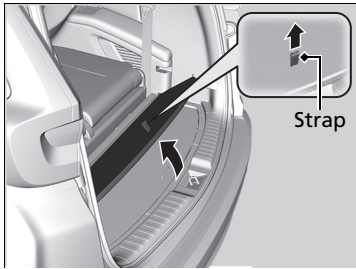

Models with third row seat

■ When putting the floor lid in the upper position

By pushing the third row seat forward and putting the floor lid in the upper position, you can store bulkier items in the luggage area.

1. Folding down the third row seat.

▣ Folding Down the Third Row Seat

P. 261

2. Pull the strap to open the luggage floor lid.
3. Pull the floor lid towards you until it disengages from the support rods.
4. Put the floor lid in the upper position, then slide it to the end.

Models with third row seat

Luggage Floor Box

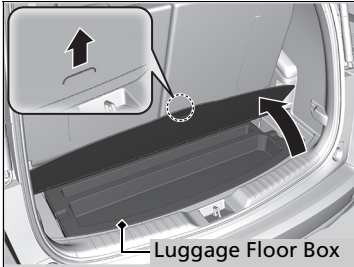

Pull up the luggage area lower floor lid.

■ Beverage Holders

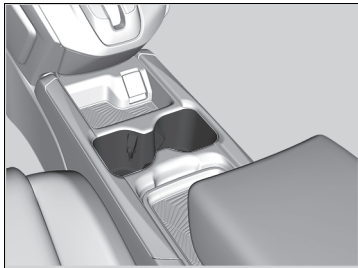

■ **Front seat beverage holders**
Are located in the console between the front seats.

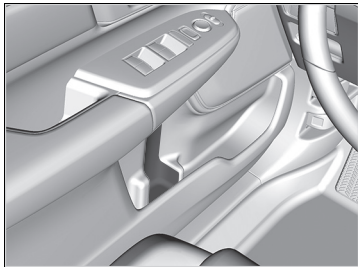

■ **Front door side beverage holders**
Are located on the both of front door side pockets.

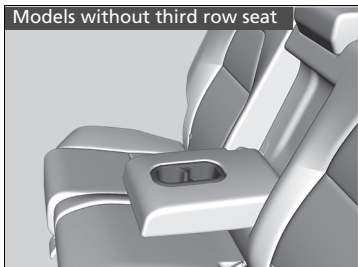

■ **Second row seat beverage holders**
Fold the armrest down to use the second row seat beverage holders.

☒ Beverage Holders

NOTICE

Spilled liquids can damage the upholstery, carpeting, and electrical components in the interior.

Be careful when you are using the beverage holders. Hot liquid can scald you.

Models with third row seat

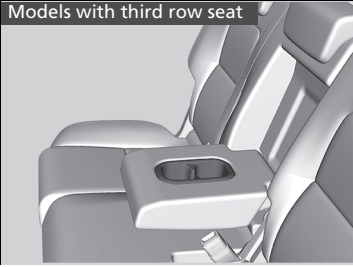

■ **Rear door side beverage holders**

Are located on the both of rear door side pockets.

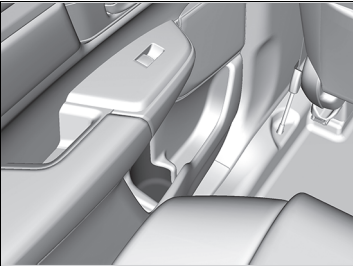

Beverage holder

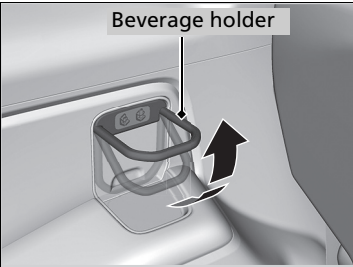

Models with third row seat

■ **Third row seat beverage holders**

Pull up the beverage holder to use it.
You can adjust the beverage holder angle depending on size of the beverage.

■ Accessory Power Sockets

The accessory power sockets can be used when the ignition switch must be in ACCESSORY **I** or ON **II***1.

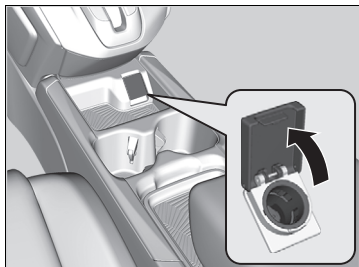

■ Console panel

Open the cover to use it.

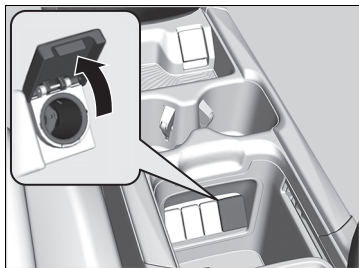

■ Console compartment

Open the cover to use it.

► Accessory Power Sockets

NOTICE

Do not insert an automotive type cigarette lighter element. This can overheat the power socket.

The accessory power socket is designed to supply power for 12-volt DC accessories that are rated 180 watts (15 amps) or less.

To prevent battery drain, only use the power socket with the engine is running.

*1: Models with the keyless access system have an **ENGINE START/STOP** button instead of an ignition switch.

Models without third row seat

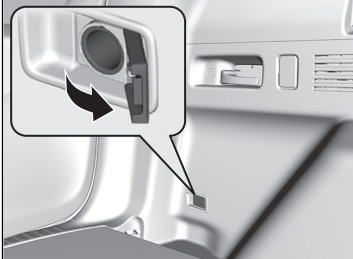

Models with third row seat

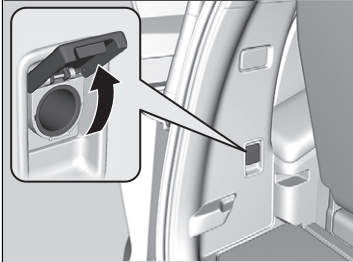

■ **Luggage area**

Open the cover to use it.

■ Coat Hook

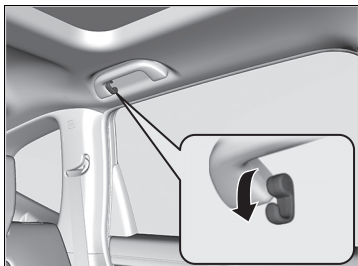

There are coat hooks on the rear left and right grab handles. Pull it down to use it.

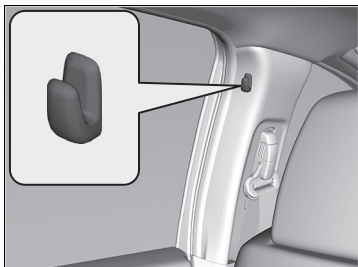

There are coat hooks on the left and right door pillars.

☒ Coat Hook

The coat hooks are not designed for large or heavy items.

■ Tie-down Anchors*

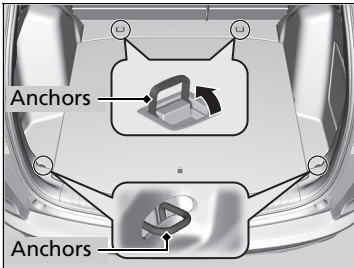

The tie-down anchors on the luggage area floor can be used to install a net for securing items.

■ Luggage Hooks*

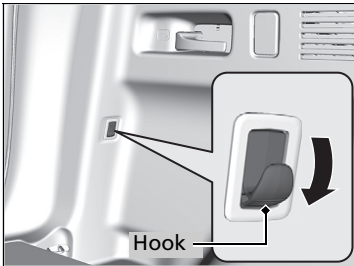

The luggage hooks on both sides of the luggage area can be used to hang a light items.

▣ Tie-down Anchors*

Do not let anyone access items in the luggage area while driving. Loose items can cause injury if you have to brake hard.

▣ Luggage Hooks*

NOTICE

Do not hang a large object or an object that weighs more than 3 kg on the side luggage hooks. Hanging heavy or large objects may damage the hooks.

* Not available on all models

■ Sunglasses Holder



To open the sunglasses holder, press and release the indent. To close, press it again until it latches.

You can store eyeglasses and other small items in this holder.



■ Conversation mirror*

The sunglasses holder comes with a mirror. Open the sunglasses holder fully, then push it back to the first detent.

You can use the mirror to view the rear seats.

☞ Sunglasses Holder

Keep the holder closed while driving except when accessing stored items.

■ Heated Steering Wheel*

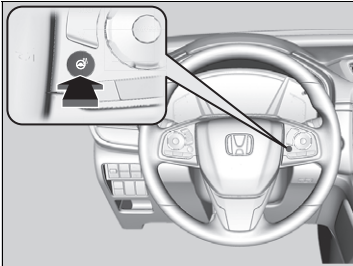

The power mode must be in ON to use the heated steering wheel.

Press the button on the right side of the steering wheel.

When a comfortable temperature is reached, press the button again to turn it off.

The heated steering wheel is turned off every time you start the engine, even if you turned it on the last time you drove the vehicle.

▣ Heated Steering Wheel*

Do not use the heated steering wheel continuously when the engine is off. Under such conditions, the battery may be weakened, making the engine difficult to start.

* Not available on all models

Front Seat Heaters *



The ignition switch must be in ON **II***1 to use the seat heaters.

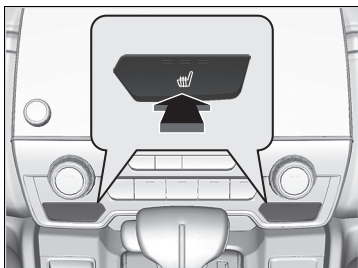

Press the seat heater button:

Once - The HI setting (three indicators on)

Twice - The MID setting (two indicators on)

Three times - The LO setting (one indicator on)

Four times - The OFF setting (no indicators on)

When the ignition switch must be in ON **II***1 after it is turned off, the previous setting of seat heaters is maintained.

Front Seat Heaters *

WARNING

Heat induced burns are possible when using seat heaters.

Persons with a diminished ability to sense temperature (e.g., persons with diabetes, lower-limb nerve damage, or paralysis) or with sensitive skin should not use seat heaters.

Do not use the seat heaters even in LO when the engine is off. Under such conditions, the battery may be weakened, making the engine difficult to start.

After a certain period of time, the strength setting for the seat heater will automatically be reduced by one level at a time until the seat heater shuts off. The elapsed time varies according to the interior environment.

*1: Models with the keyless access system have an **ENGINE START/STOP** button instead of an ignition switch.

* Not available on all models

Rear Seat Heaters*



The power mode must be in ON to use the seat heaters.

There is no heater in the rear centre seating position.

Press the seat heater button:

Once - The HI setting (three indicators on)

Twice - The MID setting (two indicators on)

Three times - The LO setting (one indicator on)

Four times - The OFF setting (no indicators on)

ⓘ Rear Seat Heaters*

⚠ WARNING

Heat induced burns are possible when using seat heaters.

Persons with a diminished ability to sense temperature (e.g., persons with diabetes, lower-limb nerve damage, or paralysis) or with sensitive skin should not use seat heaters.

Do not use the seat heaters even in LO when the engine is off. Under such conditions, the battery may be weakened, making the engine difficult to start.

After a certain period of time, the strength setting for the seat heater will automatically be reduced by one level at a time until the seat heater shuts off. The elapsed time varies according to the interior environment.

* Not available on all models

■ Luggage Area Cover*

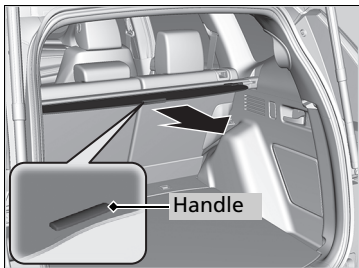

The luggage area cover can be used to conceal items in the luggage area and protect them from direct sunlight.

■ To extend:

Slightly lift up on the handle at the centre edge of the cover to unhook each end, then pull the cover rearward and clip the mounting rods in the hooks at both sides of the tailgate opening.

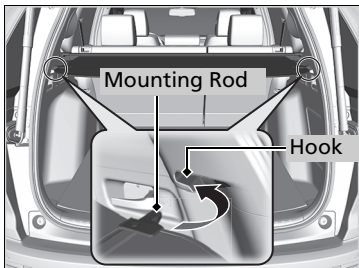

▣ Luggage Area Cover*

Do not let anyone access items in the luggage area while driving. Loose items can cause injury if you have to brake hard.

Do not stack objects higher than the top of the seat in the luggage area. They could block your view and be thrown about the vehicle during a sudden stop.

To prevent luggage area cover damage:

- Do not place items on the luggage area cover.
- Do not put weight on the luggage area cover.

Be sure that each mounting rod sets in its respective retention groove when you retract the rear luggage cover. If they are not set in the grooves, the rods may rattle as they contact the surrounding surfaces.

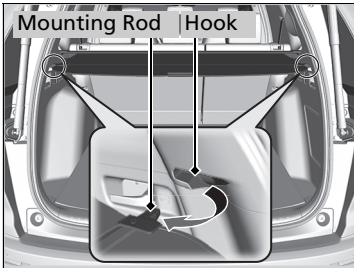

■ **To retract:**

Slip the rods out of the hooks, then slowly roll it back until it is completely retracted.

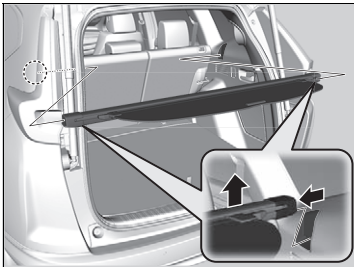

■ **To remove:**

Push either end of the housing inward, then lift it out of its position.

Using Automatic Climate Control

The automatic climate control system maintains the interior temperature you select. The system also selects the proper mix of heated or cooled air that raises or lowers the interior temperature to your preference as quickly as possible.

Models with colour audio system

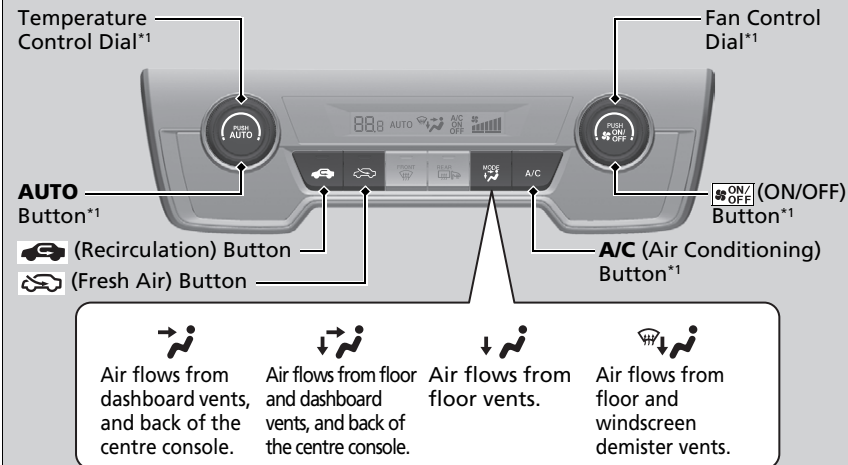

*1: Left-hand drive models shown. For the right-hand drive models, these buttons are located at the symmetrically opposite to the left-hand drive model.

Using Automatic Climate Control

Models with Display Audio

Press the **CLIMATE** button to display A/C, MODE, fan control information on the audio/information screen to operate manually. Select icon to turn on or off A/C, change the vent mode, or change the fan speed.

If any buttons are pressed while using the climate control system in auto, the function of the button that was pressed will take priority.

Models with Display Audio

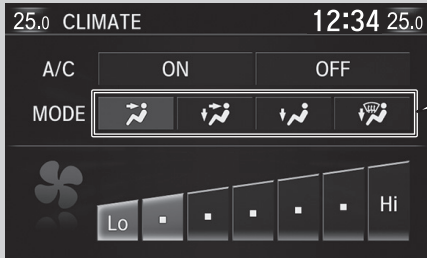

Air flows from dashboard vents, and back of the centre console.	Air flows from floor and dashboard vents, and back of the centre console.	Air flows from floor vents.	Air flows from floor and windscreen demister vents.

Driver's Side Temperature Control Dial*1

Fan Control Buttons

CLIMATE (CLIMATE) Button

SYNC (Synchronization) Button*1

Passenger's Side Temperature Control Dial*1

AUTO Button*1

ON/OFF (ON/OFF) Button*1

(Recirculation) Button

(Fresh Air) Button

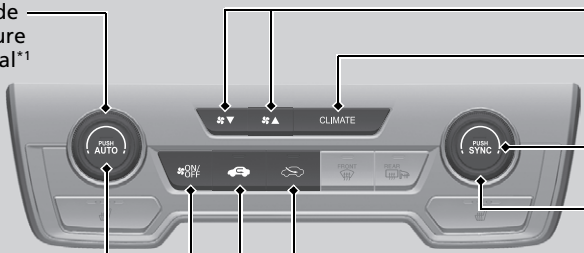

*1: Left-hand drive models shown. For the right-hand drive models, these buttons are located at the symmetrically opposite to the left-hand drive model.

Use the system when the engine is running.

1. Press the **AUTO** button.

Models with colour audio system



2. Adjust the interior temperature using the temperature control dial.

Models with Display Audio

2. Adjust the interior temperature using the driver's side or passenger's side control dial.

3. Press the  (on/off) button to cancel.

■ **Switching between the recirculation and fresh air modes**

Press the  (recirculation) or  (fresh air) button to switch the mode depending on environmental conditions.

 Recirculation mode (indicator on): Recirculates air from the vehicle's interior through the system.

 Fresh air mode (indicator on): Maintains outside ventilation. Keep the system in fresh air mode in normal situations.

►► Using Automatic Climate Control

The **AUTO** indicator will go off, but functions unrelated to the button that were pressed will be controlled automatically.

To prevent cold air from blowing in from outside, the fan may not start immediately when the **AUTO** button is pressed.

Models with Auto Idle Stop

During idle-stops, air-conditioning is suspended, and only the blower remains active.

If you do not want air-conditioning suspended, press the Auto Idle Stop system **OFF** button to cancel idle-stop.

If the interior is very warm, you can cool it down more rapidly by partially opening the windows, turning the system on **AUTO**, and setting the temperature to low. Change the fresh mode to recirculation mode until the temperature cools down.

When you set the temperature to the lower or upper limit, **Lo** or **Hi** is displayed.

Pressing the  button switches the climate control system between on and off. When turned on, the system returns to your last selection.

While **ECON** mode is active, the climate control system may have reduced cooling performance.

Defrosting the Windscreen and Windows

Models with colour audio system

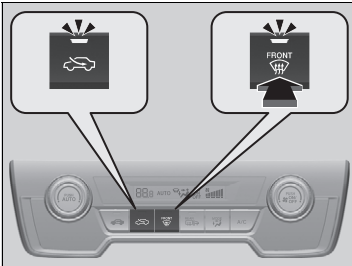

Pressing the  (windscreen demister) button turns the air conditioning system on and automatically switches the system to fresh air mode.

Press the  button again to turn off, the system returns to the previous settings.

Models with Display Audio

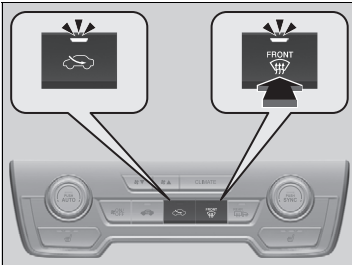

Defrosting the Windscreen and Windows

For your safety, make sure you have a clear view through all the windows before driving.

Do not set the temperature near the upper or lower limit. When cold air hits the windscreen, the outside of the windscreen may fog up.

If the side windows fog up, adjust the vents so that the air hits the side windows.

Manual transmission models

To defog during the Auto Idle Stop, restart the engine as follows.

1. Make sure the shift lever is in **[N]**.
2. Depress the clutch pedal fully.
3. Press the  button.

■ To rapidly defrost the windows

Models with colour audio system

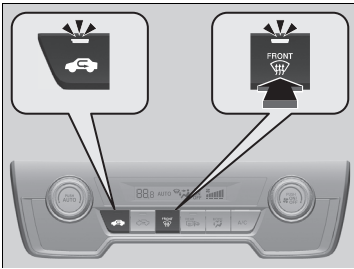

1. Press the  button (indicator on).
2. Press the  button (indicator on).

Models with Display Audio

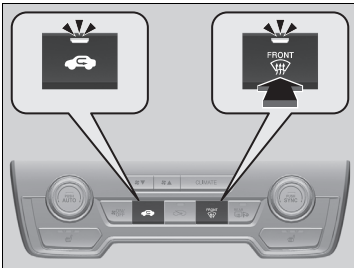

►► To rapidly defrost the windows

After defrosting the windows, switch over to fresh air mode. If you keep the system in recirculation mode, the windows may fog up from humidity. This impedes visibility.

Synchronization Mode*

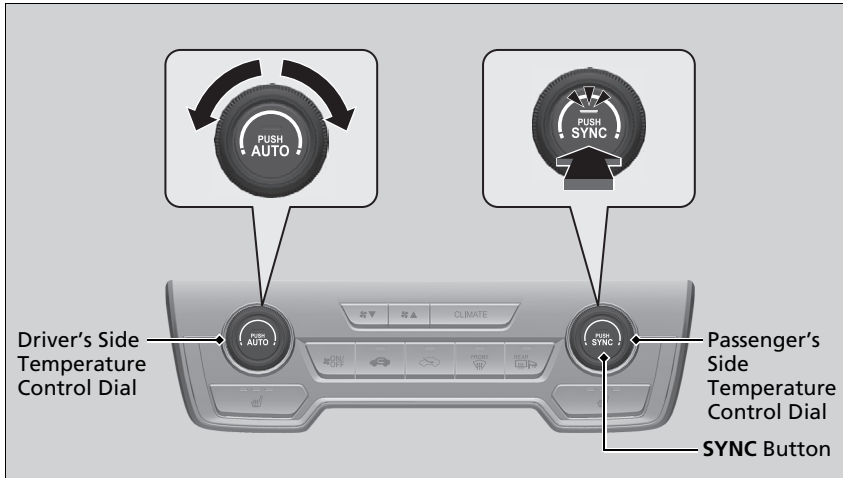

You can set the temperature synchronously for the driver's side and the passenger's side in synchronization mode.

1. Press the **SYNC** button.
 - The system switches to synchronization mode.
2. Adjust the temperature using the driver's side temperature control dial.

Press the **SYNC** button to return to dual mode.

Synchronization Mode*

When you press the  button, the system changes to synchronization mode.

When the system is in synchronization mode, the driver's side temperature and the passenger's side temperature can not be set separately.

* Not available on all models

Automatic Climate Control Sensors

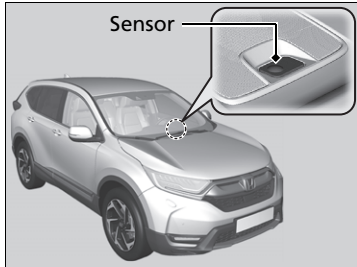

The automatic climate control system is equipped with sensors. Do not cover or spill any liquid on them.

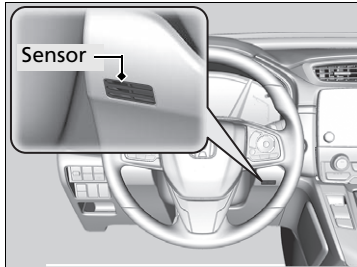

Features

This chapter describes how to operate technology features.

Audio System			
About Your Audio System.....	298		
USB Port(s).....	299		
HDMI™ Port*.....	300		
Auxiliary Input Jack*.....	300		
Audio System Theft Protection.....	301		
Audio Remote Controls.....	302		
Audio System Basic Operation	305, 332		
Audio Error Messages	398		
General Information on the Audio System	400		
Customized Features	405, 413		
		Hands-Free Telephone System441, 462	
		Emergency Call (eCall)*	
		Automatic emergency call.....	493
		Manual emergency call.....	495

* Not available on all models

About Your Audio System

The audio system features AM/FM radio. It can also play USB flash drives, and iPod, iPhone, *Bluetooth*®, and HDMI™* devices.

You can operate the audio system from the buttons and switches on the panel, the remote controls on the steering wheel, or the icons on the touchscreen interface*.

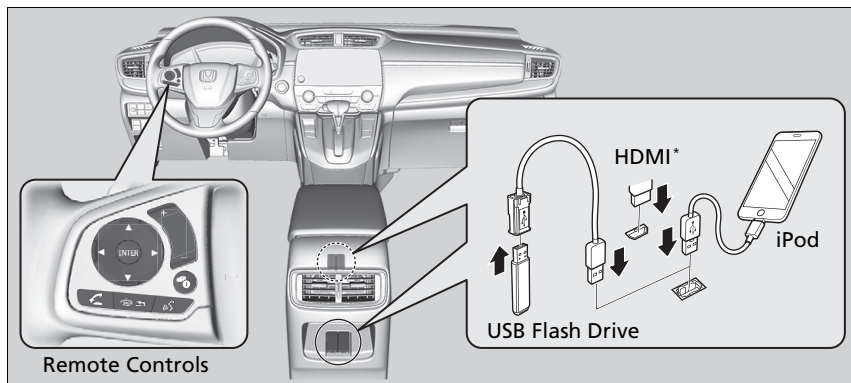

About Your Audio System

iPod, iPhone and iTunes are trademarks of Apple Inc.

Key Off Operation*

After you turn the ignition switch to LOCK [0]*1, you can use the audio system for up to 30 minutes per driving cycle. However, whether you can continue using the audio system depends on the battery condition. Repeatedly using this feature may drain the battery.

*1: Models with the keyless access system have an **ENGINE START/STOP** button instead of an ignition switch.

* Not available on all models

USB Port(s)

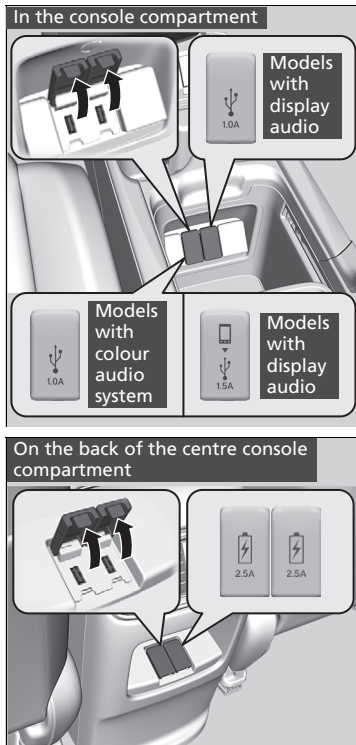

Install the iPod USB connector or the USB flash drive to the USB port.

- ▶ The USB port (1.0A) is for playing audio files on a USB flash drive, connecting a mobile phone, and charging devices.

Models with Display Audio

- ▶ The USB port (1.5A) is for charging devices, playing audio files and connecting compatible phones with smartphone connection, Apple CarPlay or Android Auto.

■ On the back of the centre console compartment*

The USB ports (2.5A) are only for charging devices.

⌘ USB Port(s)

- Do not leave the iPod or USB flash drive in the vehicle. Direct sunlight and high temperatures may damage it.
- We recommend using an extension cable with the USB port.
- Do not connect the iPod or USB flash drive using a hub.
- Do not use a device such as a card reader or hard disk drive, as the device or your files may be damaged.
- We recommend backing up your data before using the device in your vehicle.
- Displayed messages may vary depending on the device model and software version.

If the audio system does not recognise the iPod, try reconnecting it a few times or reboot the device. To reboot, follow the manufacturer's instructions provided with the iPod or visit www.apple.com/ipod.

The USB port can supply up to 1.0A/1.5A/2.5A of power. It does not output 1.0A/1.5A/2.5A unless the device requests.

For amperage details, read the operating manual of the device that needs to be charged.

Turn the ignition switch to ACCESSORY **I** or ON **II*** first.

USB Port (2.5A)

This port is for battery charge only. You cannot play music even if you have connected a music player to it.

Under certain conditions, a device connected to the port may generate noise in the radio you are listening to.

*1: Models with the keyless access system have an **ENGINE START/STOP** button instead of an ignition switch.

* Not available on all models

HDMI™ Port*

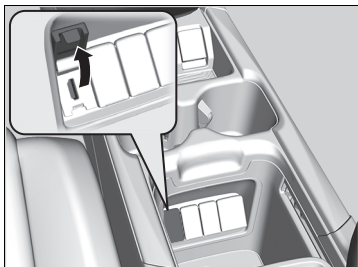

1. Open the cover.
2. Install the HDMI™ cable to the HDMI™ port.

⌘ HDMI™ Port*

- Do not leave the HDMI™ connected device in the vehicle. Direct sunlight and high temperatures may damage it.
- We recommend backing up your data before using the device in your vehicle.
- Displayed messages may vary depending on the device model and software version.

The terms HDMI and HDMI High-Definition Multimedia Interface, and the HDMI Logo are trademarks or registered trademarks of HDMI Licensing LLC in the United States and other countries.

Auxiliary Input Jack*

Use the jack to connect devices.

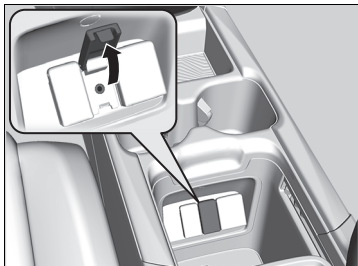

1. Open the cover.
2. Connect a device to the input jack using a 3.5 mm stereo miniplug.
 - ▶ The audio system automatically switches to the AUX mode.

⌘ Auxiliary Input Jack*

To switch the mode, press any of the audio mode buttons. You can return to AUX mode by pressing the **MEDIA** button.

You cannot use the auxiliary input jack if you replace the audio system.

Audio System Theft Protection

The audio system is disabled when it is disconnected from the power source, such as when the battery is disconnected or goes dead. In certain conditions, the system may display a code entry screen. If this occurs, reactivate the audio system.

■ Reactivating the audio system

1. Turn the ignition switch to ON *1.
2. Turn on the audio system.
3. Press and hold the audio system power button for more than two seconds.
 - ▶ The audio system is reactivated when the audio control unit establishes a connection with the vehicle control unit. If the control unit fails to recognise the audio unit, you must go to a dealer and have the audio unit checked.

*1: Models with the keyless access system have an **ENGINE START/STOP** button instead of an ignition switch.

Audio Remote Controls

Allow you to operate the audio system while driving. The information is shown on the driver information interface.

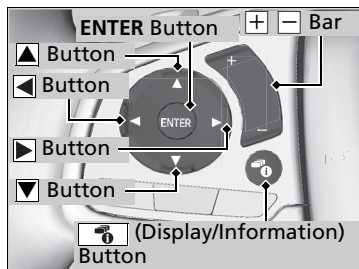

▲ ▼ Buttons

Press ▲ or ▼ to cycle through the audio mode as follows:

Models with colour audio system

FM1→FM2→DAB1→DAB2→LW→MW→
USB/iPod→Bluetooth® Audio→AUX

Models with Display Audio

FM→DAB→LW→MW→USB→iPod→
Bluetooth® Audio→Apps→Audio Apps→
AUX-HDMI™

Models with Display Audio

ENTER Button

- When listening to the radio
- 1. From the audio screen in the driver information interface, press **ENTER** to switch the display to a preset list you stored in the preset buttons.
- 2. Press ▲ or ▼ to select a preset, then press **ENTER**.
- When listening to a USB flash drive
- 1. From the audio screen in the driver information interface, press **ENTER** to display the folder list.
- 2. Press ▲ or ▼ to select a folder.
- 3. Press **ENTER** to display a list of tracks in that folder.
- 4. Press ▲ or ▼ to select a track, then press **ENTER**.

▶▶ Audio Remote Controls









Some modes appear only when an appropriate device or medium is used.

Depending on the *Bluetooth*® device you connect, some functions may not be available.

Press the  (Hang-up/back) button* to go back to the previous command or cancel a command.

Press the  (Display/information) button to switch display.

 **Switching the Display** P. 333









- When listening to an iPod
 1. From the audio screen in the driver information interface, press **ENTER** to display the iPod music list.
 2. Press  or  to select a category.
 3. Press **ENTER** to display a list of items in the category.
 4. Press  or  to select an item, then press **ENTER**.
 - ▶ Press **ENTER** and press  or  repeatedly until the desired mode you want to listen to is displayed.
- When listening to *Bluetooth*® Audio
 1. From the audio screen in the driver information interface, press **ENTER** to display the track list.
 2. Press  or  to select a track, then press **ENTER**.

  **(Volume) Bar**

Press : To increase the volume.

Press : To decrease the volume.

Buttons

- When listening to the radio
 - Press** : To select the next preset radio station.
 - Press** : To select the previous preset radio station.
 - Press and hold** : To select the next strong station.
 - Press and hold** : To select the previous strong station.
- When listening to an iPod, USB flash drive, or *Bluetooth*® Audio
 - Press** : To skip to the next song.
 - Press** : To go back to the beginning of the current or previous song.
- When listening to a USB flash drive
 - Press and hold** : To skip to the next folder.
 - Press and hold** : To go back to the previous folder.

Models with colour audio system

To use the audio system, the ignition switch must be in ACCESSORY **I** or ON **II**.

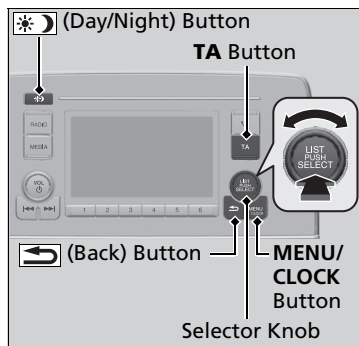

Use the selector knob or **MENU/CLOCK** button to access some audio functions.

Press to switch between the normal and extended display for some functions.

Selector knob: Rotate left or right to scroll through the available choices. Press to set your selection.

Audio System Basic Operation

These indications are used to show how to operate the selector knob.

Rotate to select.

Press to enter.

Menu Items

- Adjust Clock** P. 176
- Wallpaper Setup** P. 309
- Display Setup** P. 313
- Scan** P. 319, 321, 328
- Play Mode** P. 325, 328
- RDS Settings** P. 315
- DAB Settings** P. 321
- Bluetooth** P. 329

Press the buttons on the steering wheel to change any audio setting.

- Audio Remote Controls** P. 302

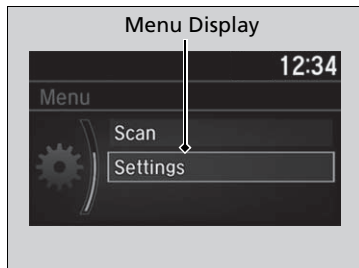



MENU/CLOCK button: Press to select any mode.

The available modes include the wallpaper, display, clock, language setup, and play modes. Play mode choices include scan, random, repeat, and so on.

 **(Back) button:** Press to go back to the previous display.

TA button: Press to activate the TA station.

 **(Day/Night) button:** Press to change the audio/information screen brightness.

Press the  button, then adjust the brightness using .

- ▶ Each time you press the  button, the mode switches between the daytime mode, nighttime mode and off mode.

Audio/Information Screen

Displays the audio status and wallpaper. From this screen, you can go to various setup options.

Switching the Display

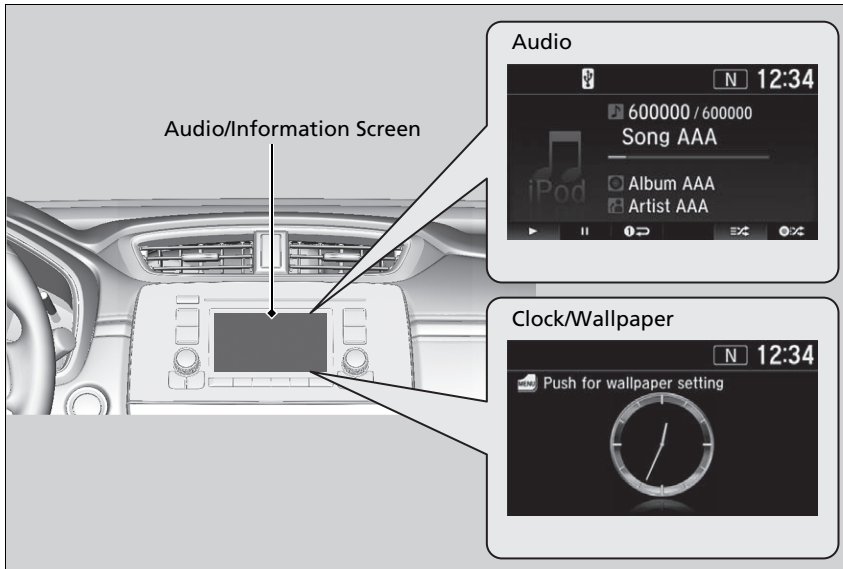







■ Audio

Shows the current audio information.

■ Clock/Wallpaper

Shows a clock screen or an image you import.

■ Change display

1. Press the **MENU/CLOCK** button.
2. Rotate  to select **Settings**, then press .
3. Rotate  to select **Display change**, then press .
4. Rotate  to select **Wallpaper**, then press .
 - ▶ If you want to return to the audio/information screen, select **Audio**.

Wallpaper Setup

You can change, store, and delete the wallpaper on the audio/information screen.

Import wallpaper

You can import up to three images, one at a time, for wallpaper from a USB flash drive.

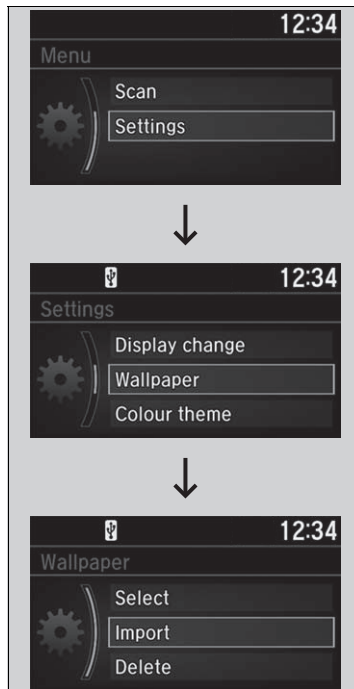









1. Connect the USB flash drive to the USB port.
▶ **USB Port(s)** P. 299
2. Press the **MENU/CLOCK** button.
3. Rotate to select **Settings**, then press .
4. Rotate to select **Wallpaper**, then press .
5. Rotate to select **Import**, then press .
▶ The picture name is displayed on the list.
6. Rotate to select a desired picture, then press .
▶ The selected picture is displayed.
7. Press to save the picture.
8. Press to select **OK**.
9. Rotate to select a location to save the picture, then press .
▶ The display will return to the wallpaper setting screen.

Wallpaper Setup







- When importing wallpaper files, the image must be in the USB flash drive's root directory. Images in a folder cannot be imported.
- The file name must be fewer than 64 characters.
- The file format of the image that can be imported is BMP (bmp) or JPEG (jpg).
- The individual file size limit is 2 MB.
- The maximum image size is 1,920 x 936 pixels. If the image size is less than 480 x 234 pixels, the image is displayed in the middle of the screen with the extra area appearing in black.
- Up to 255 files can be selected.
- If the USB flash drive does not have any pictures, the error message appears.
- The wallpaper setup is limited while driving.

Continued



■ Select wallpaper

1. Press the **MENU/CLOCK** button.
2. Rotate  to select **Settings**, then press .
3. Rotate  to select **Wallpaper**, then press .
4. Rotate  to select **Select**, then press 
 - ▶ The screen changes to the wallpaper list.
5. Rotate  to select a desired wallpaper, then press .

■ To view wallpaper once it is set

1. Press the **MENU/CLOCK** button.
2. Rotate  to select **Settings**, then press .
3. Rotate  to select **Display change**, then press .
4. Rotate  to select **Wallpaper**, then press .
5. Press the  (Back) button until the top screen is displayed.

■ Delete wallpaper

1. Press the **MENU/CLOCK** button.
2. Rotate  to select **Settings**, then press .
3. Rotate  to select **Wallpaper**, then press .
4. Rotate  to select **Delete**, then press 
 - ▶ The screen changes to the wallpaper list.
5. Rotate  to select a wallpaper that you want to delete, then press .
6. Rotate  to select **Yes**, then press 
 - ▶ The display will return to the wallpaper setting screen.



▶▶ Wallpaper Setup

To go back to the previous screen, press the  (Back) button.

When the file size is large, it takes a while to be previewed.

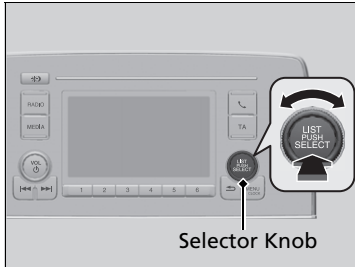
Adjusting the Sound





Press the **MENU/CLOCK** button and rotate  to select **Sound**, then press . Rotate  to scroll through the following choices:

Adjusting the Sound

The SVC has four modes: **Off**, **Low**, **Mid**, and **High**. SVC adjusts the volume level based on the vehicle speed. As you go faster, audio volume increases. As you slow down, audio volume decreases.

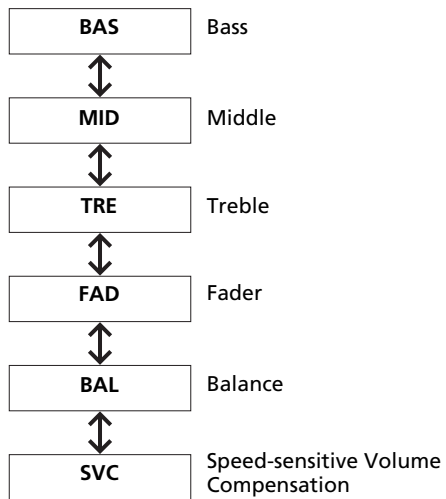
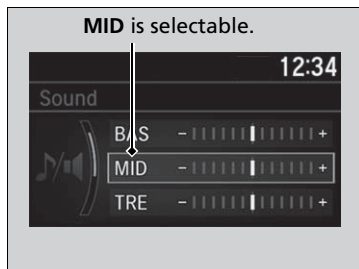
Continued











Rotate  to adjust the sound setting, then press .

Display Setup

You can change the brightness or colour theme of the audio/information screen.







Changing the Screen Brightness



1. Press the **MENU/CLOCK** button.
2. Rotate  to select **Settings**, then press .
3. Rotate  to select **Display adjustment**, then press .
4. Rotate  to select **Brightness**, then press .
5. Rotate  to adjust the setting, then press .

Changing the Screen's Colour Theme



1. Press the **MENU/CLOCK** button.
2. Rotate  to select **Settings**, then press .
3. Rotate  to select **Colour theme**, then press .
4. Rotate  to select the setting you want, then press .

Changing the Screen Brightness

You can change the **Contrast** and **Black level** settings in the same manner.

Playing AM/FM Radio

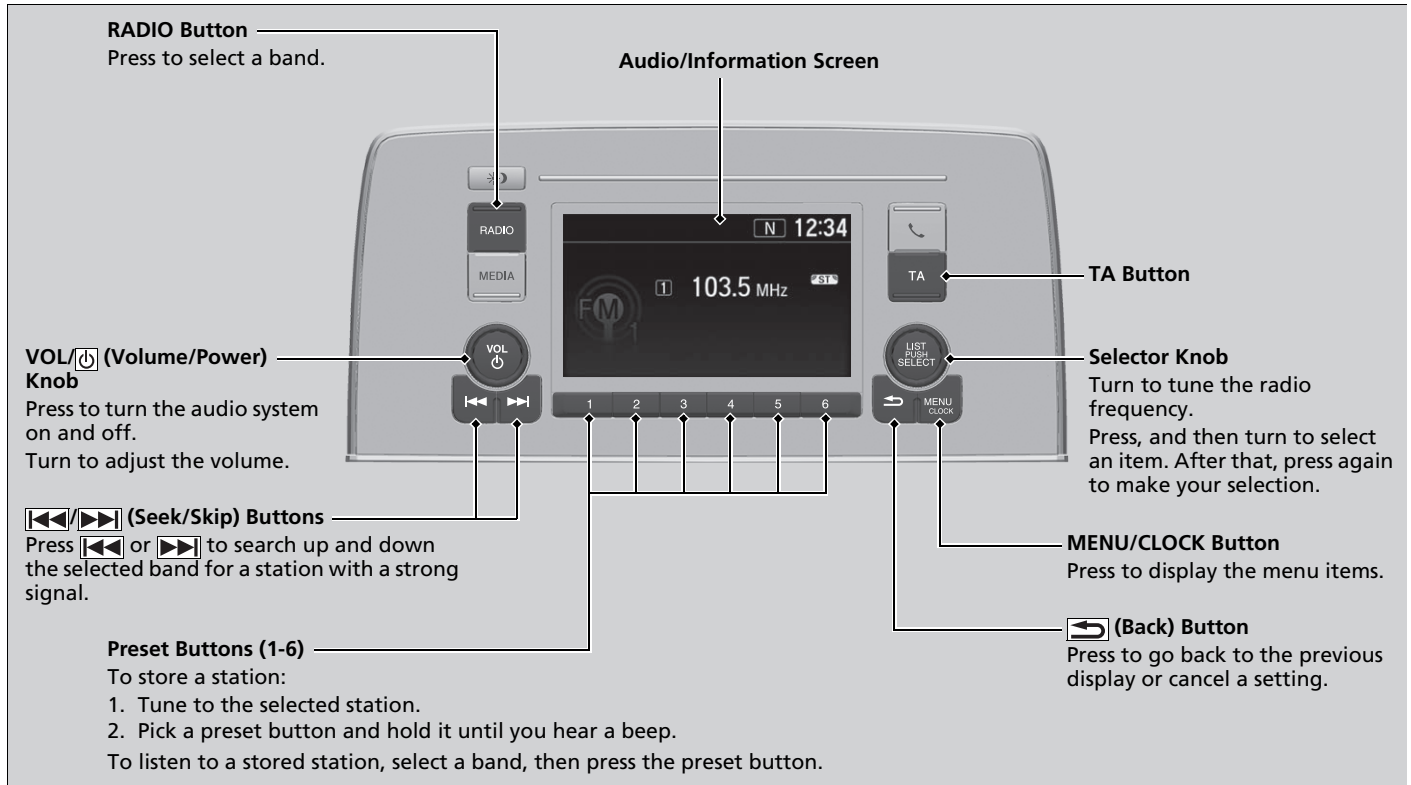



FM mode

Radio Data System (RDS)



Provides convenient automated services related to your selected RDS-capable FM station.

■ To find an RDS station from Station List

1. Press  while listening to an FM station.
2. Rotate  to select the station, then press .







■ Update List

Updates your available station list at any time.

1. Press  while listening to an FM station.
2. Rotate  to select **Update list**, then press .

■ Radio text

Displays the radio text information of the selected RDS station.

1. Press the **MENU/CLOCK** button.
2. Rotate  to select **Settings**, then press .
3. Rotate  to select **RDS settings**, then press .
4. Rotate  to select **Radio text**, then press .
 - ▶ Select **Radio text** again to turn it off.

▶▶ Playing AM/FM Radio

The **ST** indicator appears on the display indicating stereo FM broadcasts.
Stereo reproduction in AM is not available.

You can store 12 AM stations and 12 FM stations into the preset button memory. AM has two types of frequencies LW and MW, and each lets you store six stations. FM1 and FM2 let you store six stations each.

Switching the Audio Mode

Press the audio source selecting buttons on the steering wheel.

 **Audio Remote Controls** P. 302

▶▶ Radio Data System (RDS)







When you select an RDS-capable FM station, the RDS automatically turns on, and the frequency display changes to the station name. However, when the signals of that station become weak, the display changes from the station name to the frequency.

Turning the Alternative Frequency (AF) function on and off turns the RDS on and off.

Pressing  switches the function between on and off.







■ Alternative Frequency (AF)

Automatically changes the frequency of the same programme as you enter different regions.

1. Press the **MENU/CLOCK** button.
2. Rotate  to select **Settings**, then press .
3. Rotate  to select **RDS settings**, then press .
4. Rotate  to select **AF**, then press 
 - ▶ Select **AF** again to turn it off.

■ Regional Programme (REG)







Keeps the same frequency of the stations within that region even if the signal gets weak.

1. Press the **MENU/CLOCK** button.
2. Rotate  to select **Settings**, then press .
3. Rotate  to select **RDS settings**, then press .
4. Rotate  to select **REG**, then press 
 - ▶ Select **REG** again to turn it off.



Except AM/FM/DAB mode

■ News Programme (News)

Automatically tunes to the news programme.

1. Press the **MENU/CLOCK** button.
2. Rotate  to select **Settings**, then press .
3. Rotate  to select **RDS settings**, then press .
4. Rotate  to select **News**, then press 
 - ▶ Select **News** again to turn it off.

▶▶ Radio Data System (RDS)

If the system cannot find any station on **Station list**, a confirmation message for updating the list appears. Rotate  to select **Yes**, then press  to update the list.

■ Traffic announcement (TA) button

TA standby function allows the system to stand by for traffic announcements in any mode. The last tuned station must be an RDS-capable traffic programme station.

To turn the function on: Press the **TA** button. When a traffic announcement begins on your last tuned station, the system automatically switches to the FM mode. TA-INFO appears on the display. The system returns to your last selected mode after the traffic announcement is finished.

If you want to go back to your last selected mode during the traffic announcement, press the **TA** button again.

To cancel the function: Press the **TA** button.

☒ Radio Data System (RDS)

TA

When you press the **TA** button, the **TA** indicator appears on the display.

If you select **Scan** while the TA standby function is on, the system searches TP station only.

Pressing the **TA** button while the traffic announcement is on does not cancel the TA standby function.

Continued

Except AM/FM/DAB mode

■ Programme type (PTY)/News interrupt function

Allows the system to interrupt with a newscast in any mode. The last tuned station must be the NEWS PTY coded station.

To activate the function: Select **News** from **RDS settings** and display the NEWS PTY before changing to other modes. When a newscast begins on your last tuned station, the system automatically switches to the FM mode.

➤ **News Programme (News)** P. 316

The system returns to your last selected mode if changed to another programme, or signal gets weak.



■ PTY alarm

The PTY code, ALARM is used for emergency announcements, such as natural disasters. When this code is received, ALARM appears on the display and the system interrupts your audio operation.

AM (LW/MW) mode

Station List

Lists the strongest stations on the selected band.

1. Press  while listening to an AM station.
2. Rotate  to select the station, then press .

Update List

Updates your available station list at any time.

1. Press  while listening to an AM station.
2. Rotate  to select **Update list**, then press .



Scan

Samples each of the strongest stations on the selected band for 10 seconds.

1. Press the **MENU/CLOCK** button.
2. Rotate  to select **Scan**, then press .

To turn off scan, press .

▶▶ Station List

If the system cannot find any station on **Station list**, a confirmation message for updating the list appears. Rotate  to select **Yes**, then press  to update the list.

Playing DAB (Digital Audio Broadcasting)

Features

Audio/Information Screen —

RADIO Button — Press to select a band.

VOL/⏻ (Volume/Power) Knob — Press to turn the audio system on and off. Turn to adjust the volume.

Seek/Skip Buttons — Press ⏮ or ⏭ to tune a DAB ensemble.

Preset Buttons (1-6) — To store a station:
1. Tune to the selected station.
2. Pick a preset button and hold it until you hear a beep.
To listen to a stored station, select a band, then press the preset button.

The DAB signal strength indicator appears on the display when the DAB band is selected.

Selector Knob — Turn to tune the service. Press, and then turn to select an item. After that, press again to make your selection.

MENU/CLOCK Button — Press to display the menu items.



(Back) Button — Press to go back to the previous display or cancel a setting.

The diagram shows a car's audio system interface. At the top is the 'Audio/Information Screen' displaying 'Religion' and '1 AAAAA XX XXXXX'. Below the screen are several controls: a 'RADIO' button, a 'MEDIA' button, a 'VOL/⏻ (Volume/Power) Knob', six 'Preset Buttons (1-6)', a 'LIST PRESET SELECT' knob, a 'MENU/CLOCK' button, and a '(Back)' button. Callouts provide detailed instructions for each control.





Service List and Ensemble List

■ To find an DAB station from Service List or Ensemble List

To find a DAB station from the service list:

1. Press  while selecting the DAB mode.
2. Rotate  to select the station, then press .
 - ▶ If you select **Update list**, the system update the station list.

To find a DAB station from the ensemble list:

1. Press  while selecting the DAB mode.
2. Rotate  to select **Ensemble list**, then press .
3. Rotate  to select the ensemble, then press .
 - ▶ If you select **Update list**, the system update the ensemble list.

■ Scan







Samples each of the strongest stations on the selected band for 10 seconds.

1. Press the **MENU/CLOCK** button.
2. Rotate  to select **Scan**, then press .

To turn off scan, press .

■ Radio Text:

Displays the radio text information of the selected DAB station.

1. Press the **MENU/CLOCK** button.
2. Rotate  to select **Settings**, then press .
3. Rotate  to select **DAB settings**, then press .
4. Rotate  to select **Radio text**, then press .
 - ▶ Select **Radio text** again to turn it off.



☒ Service List and Ensemble List

You can store 12 DAB stations into the preset button memory. DAB1 and DAB2 let you store 6 stations each.

Switching the Audio Mode

Press the audio source selecting buttons on the steering wheel.

☒ Audio Remote Controls P. 302







If the system cannot find a station, a confirmation message for updating the list appears. Rotate  to select **Yes**, then press  to update the list.

☒ Radio Text:

The **TEXT** indicator appears on the display indicating radio text information.







■ DAB-Link:

Automatically searches for the same station from Ensembles, and switches to it.

1. Press the **MENU/CLOCK** button.
2. Rotate  to select **Settings**, then press .
3. Rotate  to select **DAB settings**, then press .
4. Rotate  to select **DAB-Link**, then press .
 - ▶ Select **DAB-Link** again to turn it off.









■ FM-Link:

If the system finds the same station from an FM band, it automatically switches the band.

1. Press the **MENU/CLOCK** button.
2. Rotate  to select **Settings**, then press .
3. Rotate  to select **DAB settings**, then press .
4. Rotate  to select **FM-Link**, then press .
 - ▶ Select **FM-Link** again to turn it off.

■ Band select:

You can select specific bands. This can reduce the time to update the lists, and search for a station.

1. Press the **MENU/CLOCK** button.
2. Rotate  to select **Settings**, then press .
3. Rotate  to select **DAB settings**, then press .
4. Rotate  to select **Band select**, then press .
5. Rotate  to select **Both**, **BandIII** or **L-Band**, then press .

Playing an iPod

Connect the iPod using your USB connector to the USB port, then press the **MEDIA** button.

📖 **USB Port(s)** P. 299

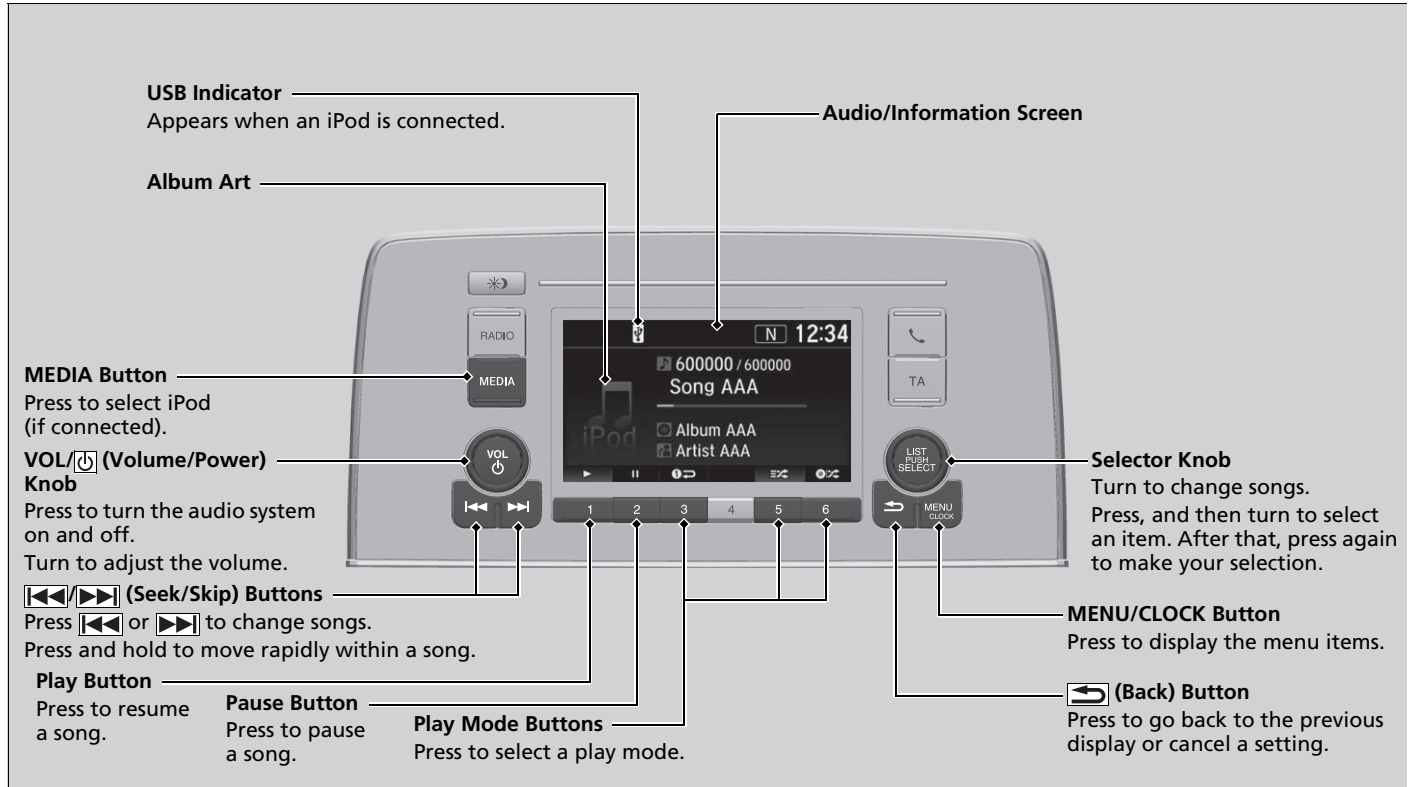

How to Select a Song from the iPod Music List with the Selector Knob

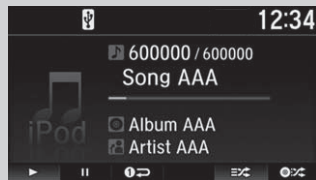

Category Selection ↓

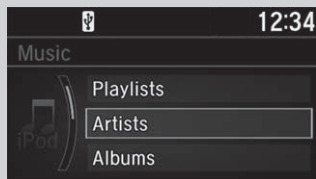

Item Selection ↓

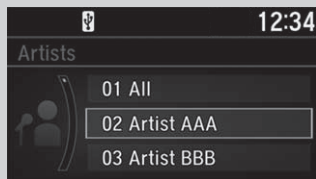

1. Press to display the iPod music list.

2. Rotate to select a category.

3. Press to display a list of items in the category.

4. Rotate to select an item, then press .

- ▶ Press and rotate repeatedly until a desired item you want to listen is displayed.

▶▶ Playing an iPod

Available operating functions vary on models or versions. Some functions may not be available on the vehicle's audio system.

If there is a problem, you may see an error message on the audio/information screen.

iPod/USB Flash Drive P. 398

How to Select a Play Mode

You can select repeat and shuffle modes when playing a song.



Available mode icons appear above the play mode buttons.

Press the button corresponding to the mode you want to select.

To turn off a play mode

Press the selected button.

How to Select a Play Mode

Play Mode Menu Items



 **Shuffle albums:** Plays all available albums in a selected category (playlists, artists, albums, songs, genres, podcasts, audiobooks, and composers) in random order.



 **Shuffle all:** Plays all available songs in a selected category (playlists, artists, albums, songs, genres, podcasts, audiobooks, and composers) in random order.

 **Repeat one track:** Repeats the current song.

You can also select a play mode by pressing the **MENU/CLOCK** button.

Rotate  to select **Play mode**, then press .

Rotate  to select a mode, then press .

To turn it off, rotate  to select **Normal play**, then press .

Playing a USB Flash Drive

Your audio system reads and plays sound files on a USB flash drive in either MP3, WMA, AAC*¹ or WAV format.

Connect your USB flash drive to the USB port, then press the **MEDIA** button.

➤ **USB Port(s)** P. 299

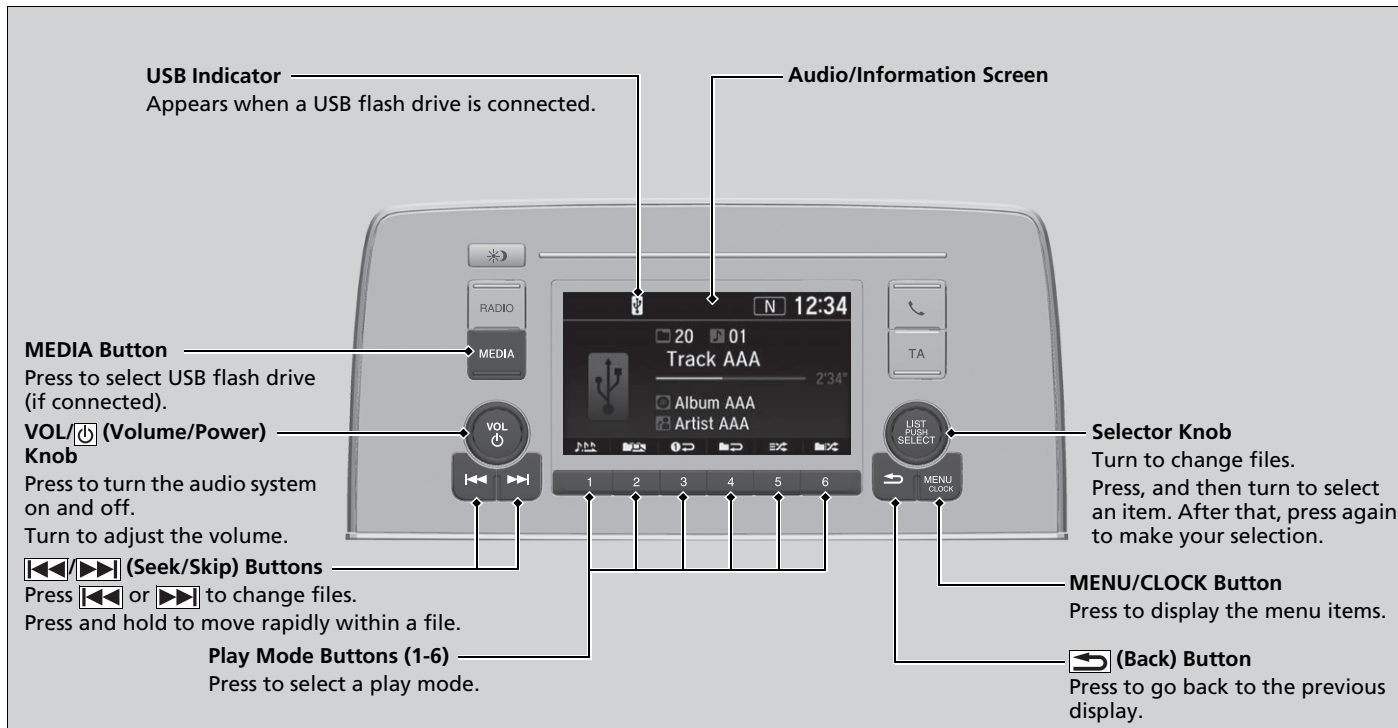

*1: Only AAC format files recorded with iTunes are playable on this unit.

How to Select a File from a Folder with the Selector Knob



1. Press to display a folder list.

2. Rotate to select a folder.

3. Press to display a list of files in that folder.

4. Rotate to select a file, then press .

▶▶ Playing a USB Flash Drive

Use the recommended USB flash drives.

▶ **General Information on the Audio System**
P. 400

Files in WMA format protected by digital rights management (DRM) cannot be played.

The audio system displays **Unplayable file**, and then skips to the next file.

If there is a problem, you may see an error message on the audio/information screen.

▶ **iPod/USB Flash Drive** P. 398

Continued

■ How to Select a Play Mode

You can select repeat, random, and scan modes when playing a file.



Available mode icons appear above the play mode buttons.

Press the button corresponding to the mode you want to select.

■ To turn off a play mode

Press the selected button.

▶▶ How to Select a Play Mode

Play Mode Menu Items

Repeat

Repeat one folder: Repeats all files in the current folder.

Repeat one track: Repeats the current file.

Random

Random in folder: Plays all files in the current folder in random order.

Random all: Plays all files in random order.

Scan

Scan folders: Provides 10-second sampling of the first file in each of the main folders.

Scan tracks: Provides 10-second sampling of all files in the current folder.

You can also select a play mode by pressing the

MENU/CLOCK button.

Rotate to select **Play mode**, then press .

Rotate to select a mode, then press .

To turn it off, rotate to select **Normal play**, then press .

Playing *Bluetooth*® Audio

Your audio system allows you to listen to music from your *Bluetooth*-compatible phone.

This function is available when the phone is paired and connected to the vehicle's Hands-Free Telephone (HFT) system.

☑ **Phone Setup** P. 447

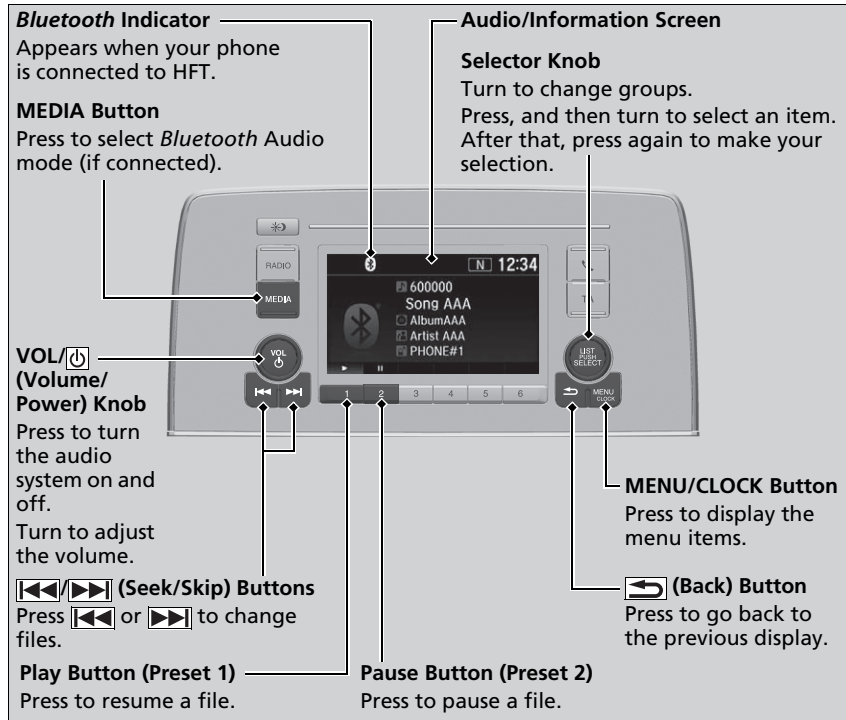

▶▶ Playing *Bluetooth*® Audio

Not all *Bluetooth*-enabled phones with streaming audio capabilities are compatible with the system. For a list of compatible phones, ask a dealer.

Only one phone can be used with HFT at a time. When there are more than two paired phones in the vehicle, the first paired phone the system finds is automatically connected.

If more than one phone is paired to the HFT system, there will be a delay before the system begins to play.

In some cases, the name of the artist, album, or track may not appear correctly.

Some functions may not be available on some devices.

Continued

■ To Play *Bluetooth*® Audio Files

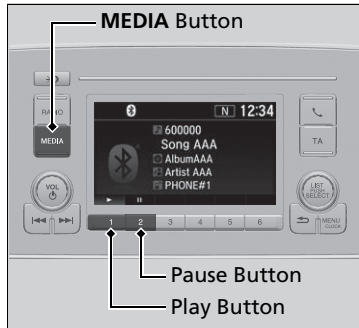

1. Make sure that your phone is paired and connected to HFT.
2. Press the **MEDIA** button until the *Bluetooth*® Audio mode is selected.

If the phone is not recognised, another HFT-compatible phone, which is not compatible for *Bluetooth*® Audio, may already be connected.

■ To pause or resume a file

Press the Play or Pause button to select a mode.

▶▶ To Play *Bluetooth*® Audio Files

To play the audio files, you may need to operate your phone. If so, follow the phone maker's operating instructions.





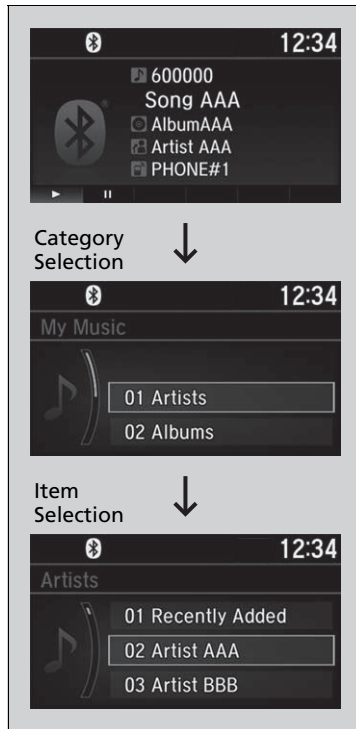

The pause function may not be available on some phones.

If any audio device is connected to the auxiliary input jack or USB port, you may need to press the **MEDIA** button repeatedly to select the *Bluetooth*® Audio system.

Switching to another mode pauses the music playing from your phone.

How to Select a Song from the Music Search List with the Selector Knob



1. Press  to display the music search list.
2. Rotate  to select a category.
3. Press  to display a list of items in the category.
4. Rotate  to select an item, then press .
 - ▶ Press  and rotate  repeatedly until a desired item you want to listen is displayed.



How to Select a Song from the Music Search List with the Selector Knob

Depending on the *Bluetooth*® device you connect, some or all of the categories may not be displayed.

Audio System Basic Operation

Models with Display Audio

You can use the audio system for 30 minutes when the ignition switch is in LOCK *1 position, the system will then turn off automatically.

If you want to keep using it, we recommend that you turn the ignition switch to ACCESSORY  or ON *1.

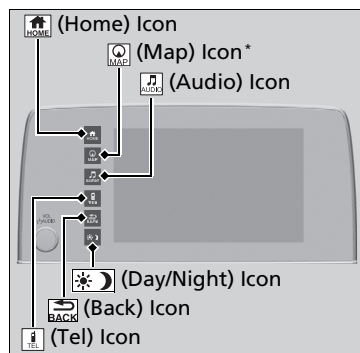

 (Home): Select to go to the home screen.

 **Switching the Display** P. 333



 (Map)*: Select to display the map screen.

 (Audio): Select to display the audio screen.

 (Tel): Select to display the phone screen.

 (Back): Select to go back to the previous screen when the icon is illuminated.

 (Day/Night): Select to change the audio/ information screen brightness.

Select  once and select  or  to make an adjustment.

▶ Each time you select , the mode switches among the daytime mode, nighttime mode and off mode.

Audio System Basic Operation

Audio Menu Items

 **Station List** P. 362, 363

 **Music Search List** P. 368, 376

 **Scan** P. 363, 377

 **Play Mode** P. 369, 377

When the battery has been reconnected or replaced, the next start-up may take a few minutes for the audio system to start. Wait a few moments while the system is starting up.

Key Off Operation*

 **About Your Audio System** P. 298

*1: Models with the keyless access system have an **ENGINE START/STOP** button instead of an ignition switch.

* Not available on all models

Audio/Information Screen

Displays the audio status and wallpaper. From this display, you can go to various setup options.

■ Switching the Display

■ Using the (display/information) button

Press the  (display/information) button to change the display.

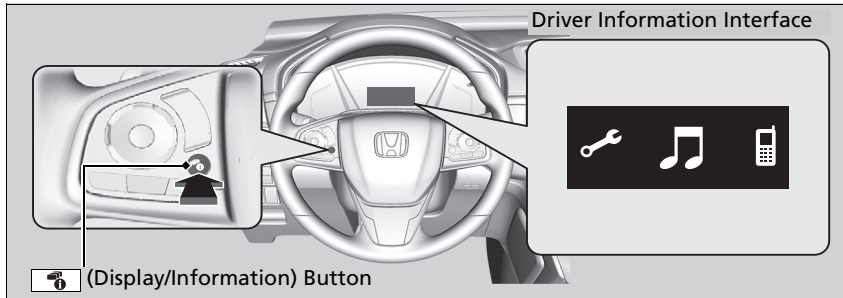



▶ Using the (display/information) button

You can edit, add, and delete the contents shown on the driver information interface.

▶ Customizing the Meter P. 337

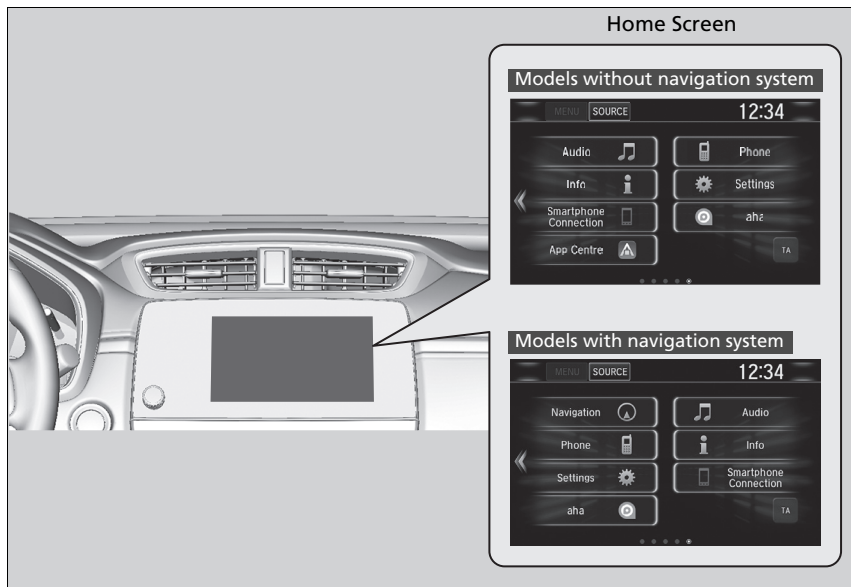
■ Using the audio/information screen



Select  to go to the home screen.

Select **Phone**, **Info**, **Audio**, **Settings**, **Navigation***, **Smartphone Connection** (**Apple CarPlay**, **Android Auto**), **aha**, **App Centre**, **TA**, **App List**, or  (instrument panel).

■ Phone

Displays the HFT information.

➤ **Hands-Free Telephone System** P. 462

▶▶ Using the audio/information screen

Touchscreen operation

- Use simple gestures - including touching, swiping and scrolling - to operate certain audio functions.
- Some items may be greyed out during driving to reduce the potential for distraction.
- You can select them when the vehicle is stopped or use voice commands*.
- Wearing gloves may limit or prevent touchscreen response.

You can change the touchscreen sensitivity setting.

➤ **Customized Features** P. 413

■ Info

Displays **Trip Computer**, **Clock/wallpaper/Clock**, or **System/Device Information**. Select **MENU** on the **Info Menu** screen to see all available options: **Trip Computer**, **Voice Info***, **Clock/wallpaper/Clock** and **System/device information**.

Trip Computer:

- **Current Drive** tab: Displays the current trip information.
- **History of Trip A** tab: Displays information for the three previous drives. The information is stored every time you reset Trip A.
To delete the history manually, select **Delete history** on the **History of Trip A** tab. The confirmation message appears on the screen, then select **Yes**.

Voice Info*: Displays a list of all voice commands.

Clock/wallpaper/Clock: Displays the clock and wallpaper.

System/device information:

- **System Info**: Displays the software version of the audio system.
- **USB info**: Displays the memory usage of the USB device.

■ Audio

Displays the current audio information.

■ Settings

Enters the customizing menu screen.

🔍 **Customized Features** P. 413

* Not available on all models

■ **Navigation***

Displays the navigation screen.

➤ **Refer to the Navigation System Manual**

■ **Smartphone Connection**

Connects with your smartphone*¹ and allows some apps on your smartphone to be used on the audio system, and displays the Apple CarPlay or Android Auto.

➤ **Apple CarPlay** P. 390

➤ **Android Auto** P. 394

■ **aha**

Displays the Aha™ screen.

➤ **Playing Aha™** P. 374

■ **App Centre**

Displays Honda App Centre.

➤ **On Board Apps** P. 382

■ **TA**

Turns on and off the traffic information.

■ **App List**

Adds or removes apps or widgets on the home screen.

➤ **Home Screen** P. 343

■ **(instrument panel)**

Selects from three customizable settings for the driver information interface.

*1: Available on specific phones only. Ask a dealer for compatible phones for feature details.

* Not available on all models

Changing the Home Screen Icon Layout



1. Select .
2. Select and hold an icon.
 - ▶ The screen switches to the customization screen.
3. Drag and drop the icon to where you want it to be.
4. Select **OK**.
 - ▶ The screen will return to the home screen.

Customizing the Meter

You can edit, add, or delete the meter contents on the driver information interface.

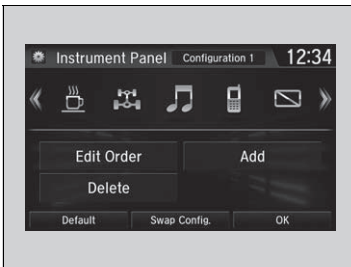

1. .
2. **Settings**
3. **System**
4. **Configuration of Instrument Panel**

Customizing the Meter

You can store up to three customized configurations. To select or customize a configuration, select **Swap Config.**

When you select **Swap Config.** during customization, the settings you changed will be saved.

When you select  during customization, the settings you changed will not be saved and you will be returned to the **Instrument Panel** screen.

■ Editing order

To change the order of the icons on the driver information interface, first select:

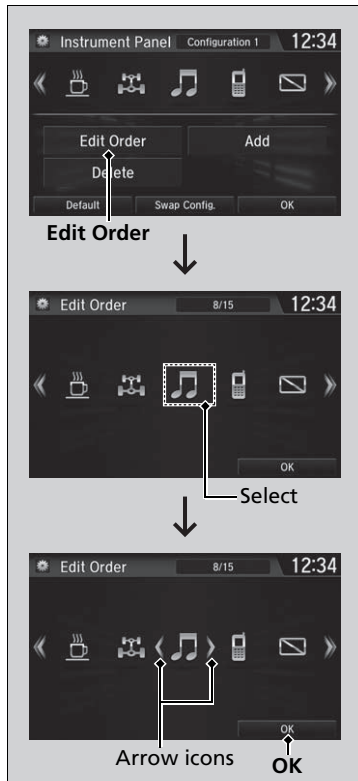

1. Edit Order

2. Select the icon you want to move.

- ▶ You will see arrows on both sides of the selected icon.

3. Select the left or right arrow repeatedly to move the icon to your desired position.

4. Select **OK**.

- ▶ The screen will return to the **Instrument Panel** screen.

▶▶ Editing order

You can use an alternative method to change the order of the icons. First select:

1. **Edit Order**

2. Select and hold the icon you want to move.
3. Drag and drop the icon to where you want it to be.
4. Select **OK**.

- ▶ The screen will return to the **Instrument Panel** screen.

■ Adding contents

You can add icons to the driver information interface. To add icons, first select:

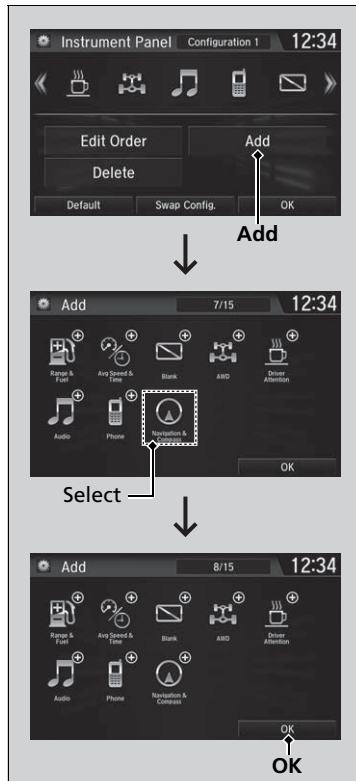

1. Add

2. Select an icon you want to add.

- ▶ You will see a plus mark on the upper right hand corner of the selected icon.

3. Select **OK**.

- ▶ The screen will return to the **Instrument Panel** screen.

▶▶ Adding contents

Icons that are greyed out cannot be selected.

If an icon has a plus mark in the upper-right corner, it means that the icon has already been added.

■ Deleting contents

To delete contents on the driver information interface, first select:

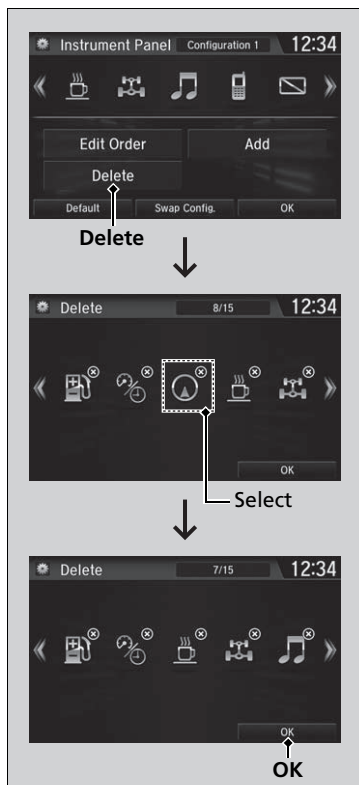

1. Delete

2. Select an icon you want to delete.

- ▶ The icon with an X on the upper right hand corner can be deleted.

3. Select OK.

- ▶ The screen will return to the **Instrument Panel** screen.

▶▶ Deleting contents

You can also delete contents by selecting:

1. **Delete** or **Edit Order**

2. Select and hold an icon you want to delete.
3. Drag and drop the icon to the trash icon.
4. Select **OK**.

- ▶ The screen will return to the **Instrument Panel** screen.

Wallpaper Setup

You can change, store, and delete the wallpaper on the audio/information screen.

Import wallpaper

You can import up to five images, one at a time, for wallpaper from a USB flash drive.

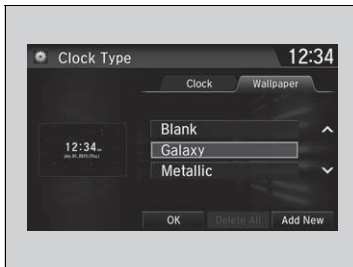

1. Connect the USB flash drive to the USB port.

➤ **USB Port(s)** P. 299

2. Select **Settings**.
3. Select **Clock**.
4. Select **Clock/Wallpaper Type**, then open the **Wallpaper** tab.
5. Select **Add New**.

▶ The picture name is displayed on the list.

6. Select a desired picture.

▶ The preview is displayed on the left side on the screen.

7. Select **Start Import** to save the data.

▶ The display will return to the wallpaper list.





Wallpaper Setup

The wallpaper you set up on **Clock/Wallpaper Type** cannot be displayed on the driver information interface.

- When importing wallpaper files, the image must be in the USB flash drive's root directory. Images in a folder cannot be imported.
- The file name must be fewer than 64 characters.
- The file format of the image that can be imported is BMP (bmp) or JPEG (jpg).
- The individual file size limit is 5 MB.
- The maximum image size is 4,096 × 4,096 pixels. If the image size is less than 800 × 480 pixels, the image is displayed in the middle of the screen with the extra area appearing in black.
- If the USB flash drive does not have any pictures, the **No files detected** message appears.

After changing the screen interface design, you can change the wallpaper by following procedure.

1. Select .
2. Select .
3. Select and hold empty space on the home screen. The pop-up menu appears on the screen.
4. Select **Change wallpaper**.
5. Select **Gallery**, **Live wallpapers**, or **Wallpapers**.

Continued

■ Select wallpaper

1. Select **Settings**.
2. Select **Clock**.
3. Select **Clock/Wallpaper Type**, then open the **Wallpaper** tab.
 - ▶ The screen changes to the wallpaper list.
4. Select a desired wallpaper.
 - ▶ The preview is displayed on the left side on the screen.
 - ▶ The pop-up menu appears on the screen.
5. Select **Set**.
 - ▶ The display will return to the wallpaper list.

■ To view wallpaper once it is set

1. Select .
2. Select **Info**.
3. Select **MENU**.
4. Select **Clock/wallpaper**.

■ Delete wallpaper

1. Select **Settings**.
2. Select **Clock**.
3. Select **Clock/Wallpaper Type**, then open the **Wallpaper** tab.
 - ▶ The screen changes to the wallpaper list.
4. Select a wallpaper that you want to delete.
 - ▶ The preview is displayed on the left side on the screen.
 - ▶ The pop-up menu appears on the screen.
5. Select **Delete**.
 - ▶ A confirmation message appears on the screen.
6. Select **Yes** to delete completely.
 - ▶ The display will return to the wallpaper list.

Wallpaper Setup

From the pop-up menu, select **Preview** to see a preview at full-size screen.



To go back to the previous screen, select **OK**, or select .

When the file size is large, it takes a while to be previewed.

To delete all wallpapers you add, select **Delete All**, then **Yes**.

Home Screen

To change to a next screen

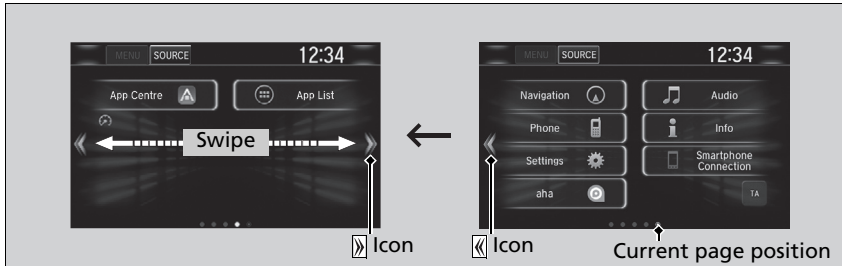

Selecting or , or swiping the screen left or right changes to the next screen.

Home Screen

The home screen has 5 pages (fixed). You cannot add any more pages.





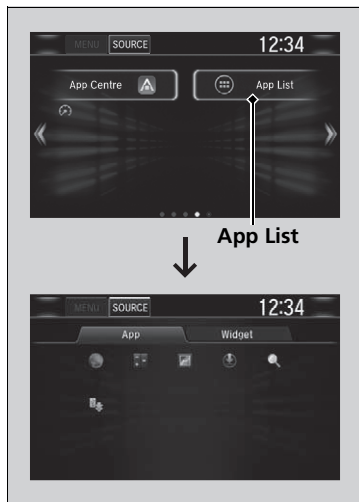

Select to go directly back to the first page of the home screen from any page.

■ To use apps or widgets



1. Select .
2. Select **App List**.
▶ The apps screen appears.
3. Select the app or widget you want to use.

Preinstall app list:

-  (Browser): Displays the web browser utilized by smartphone and Wi-Fi connection.
-  (Calculator): Displays Calculator.
-  (Gallery): Displays images.
-  (Downloads): Displays the data downloaded from the web browser and so on.
-  (App installer): Check with a Honda dealer for apps that are available for installation.
-  (Search): Displays various retrieval screen.

▶▶ To use apps or widgets

Select and hold a selected app or widget to add that app's or widget's shortcut on the home screen.

Pre-installed apps may not start up normally. If this occurs, you need to reset the system.

▶ **Defaulting All the Settings** P. 440

If you perform **Factory Data Reset**, it may reset all the settings to their factory default.

▶ **Defaulting All the Settings** P. 440

In case those apps still do not startup normally even after **Factory Data Reset**, contact your dealer.

There is a possibility that a browser is shut down in the situation of the use. In that situation, the screen will return to before the browser startup.

Do not install apps other than those confirmed by a Honda dealer. Installation of unauthorised apps may introduce data corruption risks to your vehicle's information and your privacy.

You can delete user installed apps by the following procedure.



1. Select .
2. Select **Settings**.
3. Select **System**.
4. Select the **Others** tab.
5. Select **Detailed Information**.
6. Select an App that you want to delete.
7. Select **Delete**.

Pre-installed apps cannot be deleted.

■ To add app or widget icons on the home screen

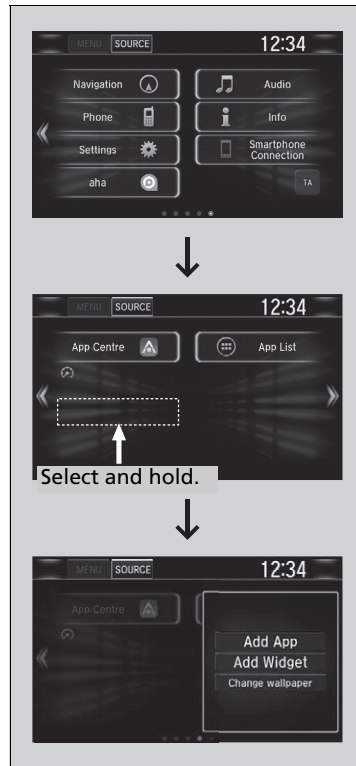
App or widget icons can be added on the home screen.



1. Select .
2. Select .

3. Select and hold empty space on the home screen.
 - ▶ The pop-up menu appears on the screen.

4. Select **Add App** or **Add Widget**.
 - ▶ The apps/widget screen appears.



5. Select and hold an app or widget icon you want to add.
 - ▶ The screen switches to the customization screen.
6. Drag and drop the icon to where you want it to be.
7. Select **OK**.
 - ▶ The screen will return to the home screen.

■ To move icons on the home screen

You can change location on the home screen.

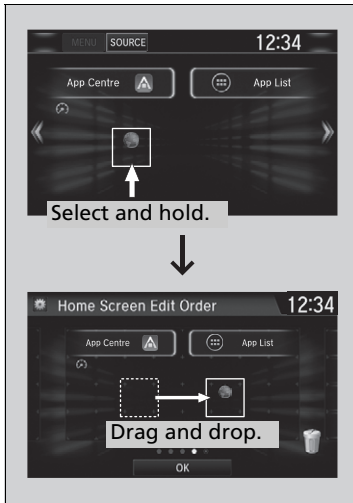

1. Select and hold an icon.
 - ▶ The screen switches to the customization screen.
2. Drag and drop the icon to where you want it to be.
3. Select **OK**.
 - ▶ The screen will return to the home screen.

☒ To move icons on the home screen

You can also move the **Phone, Info, Audio, Settings, Navigation**, **Smartphone Connection, aha, App Centre, TA, App List**, and  (instrument panel) icons in the same manner.

■ To remove icons on the home screen

You can delete the icons on the home screen.



1. Select and hold an icon.
 - ▶ The screen switches to the customization screen.
2. Drag and drop the icon you want to remove to the trash icon.
 - ▶ The icon is removed from the home screen.
3. Select **OK**.
 - ▶ The screen will return to the home screen.

▶▶ To remove icons on the home screen

You cannot delete the **Phone, Info, Audio, Settings, Navigation, Smartphone Connection, aha, App Centre, TA, App List**, and  (instrument panel) icons.

Apps or widgets will not be deleted by deleting the icon on the home screen.

■ To change the home screen wallpaper

You can change a wallpaper of the home screen.



1. Select and hold empty space on the home screen.
 - ▶ The pop-up menu appears on the screen.
2. Select **Change wallpaper**.
 - ▶ The pop-up menu appears on the screen.

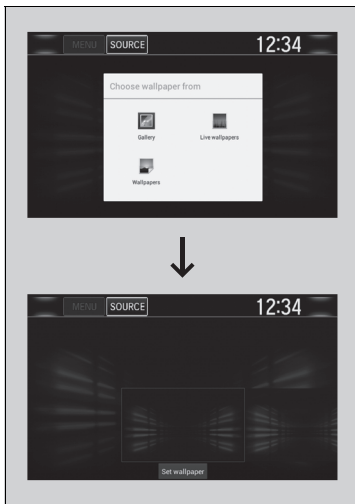

3. Select an app for selecting wallpapers.
4. Select the wallpaper you want to change.
5. Select **Set wallpaper**.
 - ▶ The wallpaper is changed, then the screen will return to the home screen.

■ Status Area

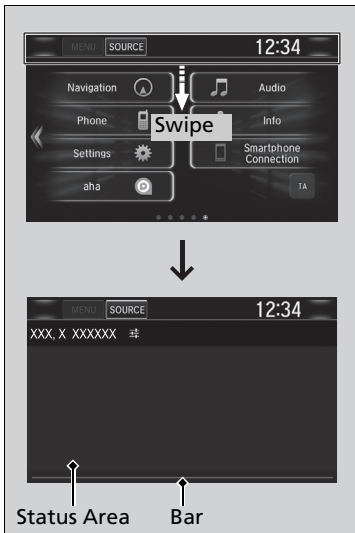

1. Swipe the upper area of the screen.
▶ The status area appears.

2. Select an item to see the details.
3. Select **BACK** or swipe up the bottom bar to close the area.

Changing the Screen Interface



You can change the screen interface design.



1. Select .
2. Select **Settings**.
3. Select **System**.
4. Select the **Others** tab.
5. Select **Change Skin**.
6. Select **Yes**.

Changing the Screen Interface

After changing the screen interface design, you can change the wallpaper by following procedure.

1. Select .
2. Select .
3. Select and hold empty space on the home screen.
The pop-up menu appears on the screen.
4. Select **Change wallpaper**.
5. Select **Gallery**, **Live wallpapers**, or **Wallpapers**.

If you change the screen interface, some of the setting items will change.

 **Customized Features** P. 413

Menu Customize

You can change menu icons on the right side of **Audio**, **Phone**, and **Info** screen.

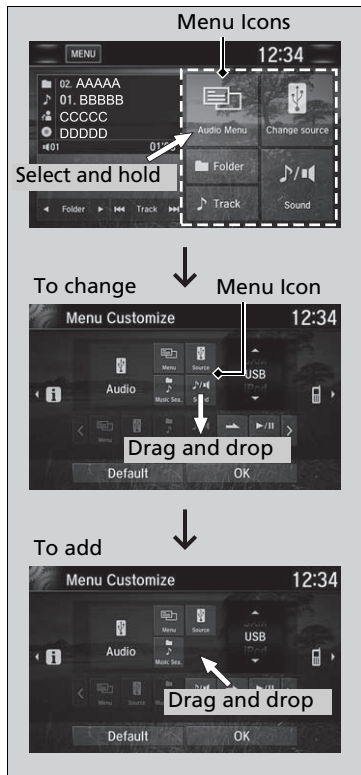

1. Select any of the three icons (**Audio/Phone/Info**) on the screen, then select and hold the menu icon.

▶ Selecting the ◀ or ▶ icon, you can change **Audio**, **Phone**, or **Info** on the **Menu Customize** screen.

2. Select and hold the menu icon you want to change, then drag and drop the icon to the bottom.

3. Select and hold the menu icon you want to add, then drag and drop the icon above.

4. Select **OK**.

Menu Customize

You can also use the method below to change the menu icon:

Select **Settings**→**System**→**Home tab**→**Menu Icon Position**

■ Closing Apps

You can close specific apps running in the background on the system.

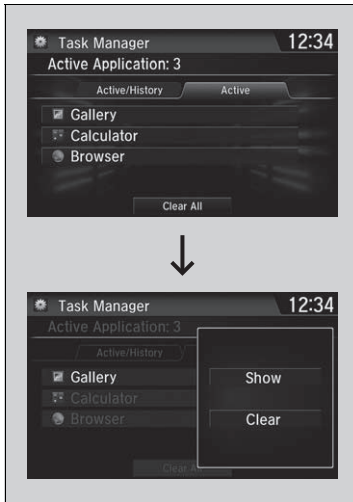

1. Select and hold .
2. Select the **Active** tab.
 - ▶ If you select the **Active/History** tab, you can close the apps that are currently running and delete the app activity history simultaneously.
3. Select an app you want to close.
4. Select **Clear**.
 - ▶ The display will return to the app list.

⌘ Closing Apps

If you have a number of apps running in the background and something goes wrong with the audio system, some of those apps may not work properly. If this happens, close all the apps and re-launch the app/apps that you want to use.

To close all apps on the system, select **Clear All**, then **Yes**.

You cannot close the Aha™ and Garmin* apps.

* Not available on all models

Adjusting the Sound

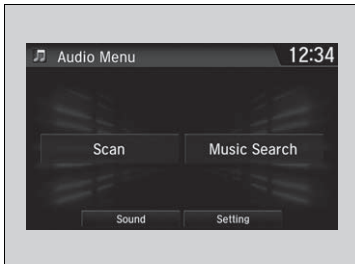

1. Select .
2. Select **MENU**.
3. Select **Sound**.

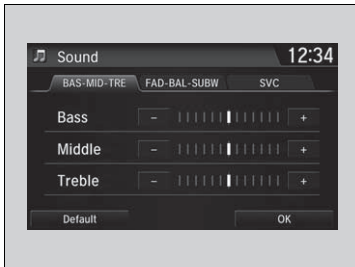

Select a tab from the following choices:

- **BAS-MID-TRE:** Bass, Middle, Treble
- **FAD-BAL-SUBW*:** Fader, Balance, Subwoofer
- **SVC:** Speed Volume Compensation

▶▶ Adjusting the Sound

The SVC has four modes: **Off**, **Low**, **Mid**, and **High**. SVC adjusts the volume level based on the vehicle speed. As you go faster, audio volume increases. As you slow down, audio volume decreases.

Display Setup

You can change the brightness or colour theme of the audio/information screen.

Changing the Screen Brightness

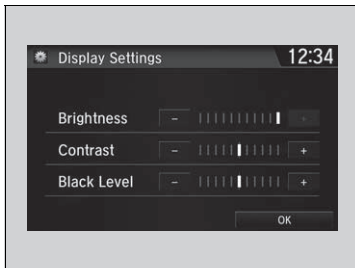

1. Select .
2. Select **Settings**.
3. Select **System**.
4. Select the **Display** tab.
5. Select **Display Settings**.
6. Select the setting you want.
7. Select **OK**.

Changing the Screen's Colour Theme

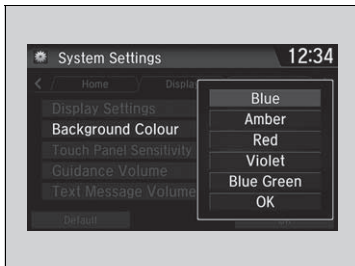

1. Select .
2. Select **Settings**.
3. Select **System**.
4. Select the **Display** tab.
5. Select **Background Colour**.
6. Select the setting you want.
7. Select **OK**.

Changing the Screen Brightness

You can change the **Contrast** and **Black Level** settings in the same manner.

■ Selecting an Audio Source



Select the current source icon, then select an icon on the source list to switch the audio source.

▶▶ Selecting an Audio Source

If you startup preinstalled audio apps, **AUDIO Apps** is displayed on the screen.

These preinstalled apps cannot be displayed on the source select screen.



You can startup those audio apps from **AUDIO Apps**.

When you are using the Aha™ screen and you want to select another source, select **SOURCE** on the upper left of the screen. The source select screen will appear. Select the source you want.

Models with navigation system

Voice Control Operation*1

Your vehicle has a voice control system that allows hands-free operation.

The voice control system uses the  (Talk) and  (hang-up/back) buttons on the steering wheel and a microphone near the map lights in the ceiling.

Voice Recognition

To achieve optimum voice recognition when using the voice control system:

- Make sure the correct screen is displayed for the voice command that you are using.

The system recognizes only certain commands.

Available voice command

 **Voice Portal Screen*** P. 358



- Close the windows and sunroof*.
- Adjust the dashboard and side vents so air does not blow onto the microphone in the ceiling.
- Speak clearly in a natural speaking voice without pausing between words.
- Reduce any background noise if possible. The system may misinterpret your command if more than one person is speaking at the same time.

*1: Languages that the voice control system recognises are English, German, French, Spanish, and Italian.

* Not available on all models

Continued

Voice Control Operation*1

When you press the  button, a helpful prompt asks what you would like to do. Press and release the  button again to bypass this prompt and give a command.

Voice Recognition

The voice control system can only be used from the driver's seat because the microphone unit removes noises from the front passenger's side.

■ Voice Portal Screen *

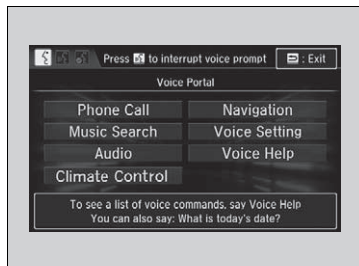

When the  (Talk) button is pressed, available voice commands appear on the screen.

For a complete list of commands, say "Voice Help" after the beep or select **Voice Help**.

You can see the list of commands in **Voice Info** on the **Info Menu** screen. Select **Info**, then select **MENU**.

The system only recognises the commands on the following pages, at certain screens. Free form voice commands are not recognised.

■ Phone Call

This can be only used when the phone is connected. When the system recognises the *Phone call* command, the screen will change to the voice recognition screen for phone commands.

- *Dial by Number*
- *Call History*
- *Redial*
- *Call <Your contact Name>*
- *Call <Phone Number>*

Phone Call commands are not available if using Apple CarPlay.

■ Music Search

This can be only used when the iPod or USB device is connected.

■ Climate Control

When the system recognises the *Climate Control* command, the screen will change the dedicated screen to the climate control voice recognition screen.

➤ **Climate Control Commands** P. 360

■ Audio

When the system recognises the *Audio* command, the screen will change to the audio voice recognition screen.

- *Audio On**1
- *Audio Off**1
- *Radio FM*
- *Radio MW*
- *Radio LW*
- *iPod*
- *USB*
- *Other Sources*

■ Navigation

The screen changes to the navigation screen.

➤ **Refer to the Navigation System Manual**

■ Voice Setting

The screen changes to the **Voice Recog.** tab on the **System Settings** screen.

*1: These commands toggle the function on and off, so the command may not match your intended action.

■ Voice Help

You can see a list of the available commands on the screen.

- *Useful Commands*
- *Phone Commands*
- *Audio Commands*
- *On Screen Commands*
- *Music Search Commands*
- *General Commands*
- *Climate Control Commands*

■ Useful Commands

The system accepts these commands on the voice portal top screen.

- *Call <Phone Number>*
- *Call <Your contact Name>*
- *What time is it?*
- *What is today's date?*

■ Phone Commands

The system accepts these commands on the dedicated screen for the voice recognition of the phone.

- *Call by number*
- *Call by name*
- *Call <Phone Number>*
- *Call <Your contact Name>*

■ Audio Commands

The system accepts these commands on the dedicated screen for the voice recognition of the audio.

■ Radio FM Commands

- *Radio tune to <87.5-108.0> FM*
- *Radio FM preset <1-12>*

■ Radio LW Commands

- *Radio tune to <153-279> LW*
- *Radio LW preset <1-6>*

■ Radio MW Commands

- *Radio tune to <531-1602> MW*
- *Radio MW preset <1-6>*

■ iPod Commands

- *iPod play*

- *iPod play track <1-30>*
- *Music Search*
- *What album is this?*
- *What am I listening to?*

■ USB Commands

- *USB play*
- *USB play track <1-30>*
- *Music Search*
- *What album is this?*
- *What am I listening to?*

■ DAB Commands

- *DAB preset <1-12>*

■ Bluetooth® audio Commands

- *Bluetooth® audio play*

NOTE:

Bluetooth® Audio commands may not work on some phones or *Bluetooth®* Audio devices.

■ HDMI™ Commands

- *HDMI Play*

■ On Screen Commands

When **On Screen Commands** is selected, the explanation screen is displayed.

■ Music Search Commands

The system accepts these commands on the **Music Search** screen.

■ Using Song By Voice

Song By Voice™ is a feature that allows you to select music from your iPod or USB device using Voice Commands. To activate this mode, you must push the talk switch and say: "Music search".

■ Song By Voice Commands

- *What am I listening to?*
- *Who am I listening to?*
- *Who is this?*
- *What's playing?*
- *Who's playing?*
- *What album is this?*

■ Play Commands

- *Play artist <Name>*
- *Play track/song <Name>*
- *Play album <Name>*
- *Play genre/category <Name>*
- *Play playlist <Name>*
- *Play composer <Name>*

■ List Commands

- *List artist <Name>*
- *List album <Name>*
- *List genre/category <Name>*
- *List playlist <Name>*
- *List composer <Name>*

■ General Commands

- *What time is it?*
- *What is today's date?*

■ Climate Control Commands

- *Climate control on*1*
- *Climate control off*1*
- *Fan speed <1-7>*
- *Temperature max heat*
- *Temperature max cool*
- *Temperature <18-32> degrees*
- *Defrost On*1*
- *Defrost Off*1*
- *Air Conditioner On*1*
- *Air Conditioner Off*1*
- *More*
- *Vent*
- *Dash and floor*
- *Fan speed up*
- *Fan speed down*
- *Floor vents*
- *Floor and Defrost*
- *Temperature up*
- *Temperature down*

*1: These commands toggle the function on and off, so the command may not match your intended action.

Playing AM/FM Radio

The diagram illustrates the car's audio system interface. At the top, the **Driver Information Interface** displays a speedometer (0-8 x1000 km/h), a gear indicator (P), and a speed of 0 km/h. Below this is the **Audio/Information Screen**, which shows the radio frequency (87.9 MHz), station name (AAA), and preset buttons (1-6). The screen also displays the temperature (23°C) and distance to the next station (A 323.4 km).

The main control panel features a **VOL/POWER AUDIO (Volume/Power Audio) Knob** on the left. To its right are several icons: **Audio Icon**, **Back Icon**, **Menu Icon**, **Map Icon**, **TEL Icon**, and **BACK Icon**. The central screen displays the time (12:34) and radio frequency (87.9 MHz). Below the screen are **Tune Icons** (left and right arrows) and **Seek Icons** (double left and double right arrows). At the bottom of the screen are **Preset Icons** (1-6) and a **Open/Close Icon** (two vertical bars).

Scan Icon — Select to scan each station with a strong signal.

(Audio) Icon — Select to display the audio screen.

(Back) Icon — Select to go back to the previous display.

VOL/POWER AUDIO (Volume/Power Audio) Knob — Press to turn the audio system on and off. Turn to adjust the volume.

Tune Icons — Select ◀ or ▶ to tune the radio frequency.

Preset Icons — Tune the preset radio frequency. Select and hold the preset icon to store that station. Select ▶▶ to display preset 7 onwards.

Open/Close Icon** — Displays/hides the detailed information.

Seek Icons — Select ▶▶ or ◀◀ to search the selected band up or down for a station with a strong signal.

*1:Some or all of the lists may not be displayed.

■ Preset Memory

To store a station:

1. Tune to the selected station.
2. Select and hold the preset number for the station you want to store.

You can also store a preset station by the following procedure.

1. Tune to the selected station.
2. Select the open/close icon to display a list.
3. Select the **Preset** tab.
4. Select and hold the preset number for the station you want to store.

■ Station List

Lists the strongest stations on the selected band.

1. Select the open/close icon to display a list.
2. Select the **Station List** tab.
3. Select the station.

■ Manual update

Updates your available station list at any time.

1. Select the open/close icon to display a list.
2. Select the **Station List** tab.
3. Select **Refresh**.

▶▶ Preset Memory

The **ST** indicator appears on the display indicating stereo FM broadcasts. Stereo reproduction in AM is not available.

Switching the Audio Mode

Press the ▲ or ▼ button on the steering wheel or select **SOURCE** on the screen.

▶▶ **Audio Remote Controls** P. 302

You can store 12 AM stations and 12 FM stations into preset memory. AM has two types of frequencies LW and MW, and each lets you store six stations.

■ Scan

Samples each of the strongest stations on the selected band for 10 seconds. To turn off scan, select **Cancel** or .

■ Radio Data System (RDS)

Provides text data information related to your selected RDS-capable FM station.

■ To find an RDS station from Station List

1. Select the open/close icon to display a list while listening to an FM station.
2. Select the **Station List** tab.
3. Select the station.

■ Manual update

Updates your available station list at any time.

1. Select the open/close icon to display a list while listening to an FM station.
2. Select the **Station List** tab.
3. Select **Refresh**.

■ Radio text

Displays the radio text information of the selected RDS station.

1. Select **MENU**.
2. Select **View Radio Text**.

■ Scan

Samples each of the strongest stations on the selected band for 10 seconds.

To turn off scan, select **Cancel** or .

☒ Radio Data System (RDS)

When you select an RDS-capable FM station, the RDS automatically turns on, and the frequency display changes to the station name. However, when the signals of that station become weak, the display changes from the station name to the frequency.

Playing DAB (Digital Audio Broadcasting)

Features



Driver Information Interface

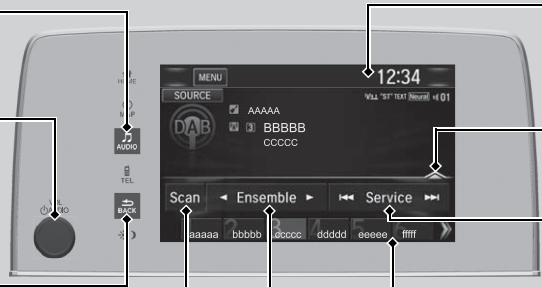

Audio/Information Screen

Open/Close Icon*
Displays/hides the detailed information.

Service Icons
Select [◀◀] or [▶▶] to tune the service component.

Preset Icons
Tune the preset frequency. Select and hold the preset icon to store that station. Select [▶▶] to display preset 7 onwards.

(Audio) Icon
Select to display the audio screen.

VOL/⏻ AUDIO (Volume/Power Audio) Knob
Press to turn the audio system on and off.
Turn to adjust the volume.

(Back) Icon
Select to go back to the previous display.

Scan Icon
Select to scan each receivable ensemble or service.

Ensemble Icons
Select [◀] or [▶] to tune the ensemble.
Select and hold [◀] or [▶] to search the selected service up to down for an ensemble until an receivable ensemble is found.

*1:Some or all of the lists may not be displayed.

■ Preset Memory

To store a service:

1. Tune to the selected service.
2. Select and hold the preset number for the service you want to store.

You can also store a preset service by the following procedure.

1. Tune to the selected service.
2. Select the open/close icon to display a list.
3. Select the **Preset** tab.
4. Select and hold the preset number for the service you want to store.

■ Ensemble List

Lists the receivable ensembles on the selected service.

1. Select the open/close icon to display a list.
2. Select the **Ensemble List** tab.
3. Select the ensemble.

■ Manual update

Updates your available ensemble list at any time.

1. Select the open/close icon to display a list.
2. Select the **Ensemble List** tab.
3. Select **Update List**.

▶▶ Preset Memory

Switching the Audio Mode

Press the ▲ or ▼ button on the steering wheel or select **SOURCE** on the screen.

▶▶ **Audio Remote Controls** P. 302

You can store 12 DAB stations into preset memory.

■ Scan

Samples each of the receivable ensemble or service on the selected service for 10 seconds.

1. Select **Scan**.
2. Select **Scan Ensemble** or **Scan Service**.

To turn off scan, select **Cancel Scan**.

■ Radio text

Displays the radio text information of the selected DAB station.

1. Select **MENU**.
2. Select **View Radio Text**.

Playing an iPod

Connect the iPod using your USB connector to the USB port, then select the iPod mode.

🔗 **USB Port(s)** P. 299

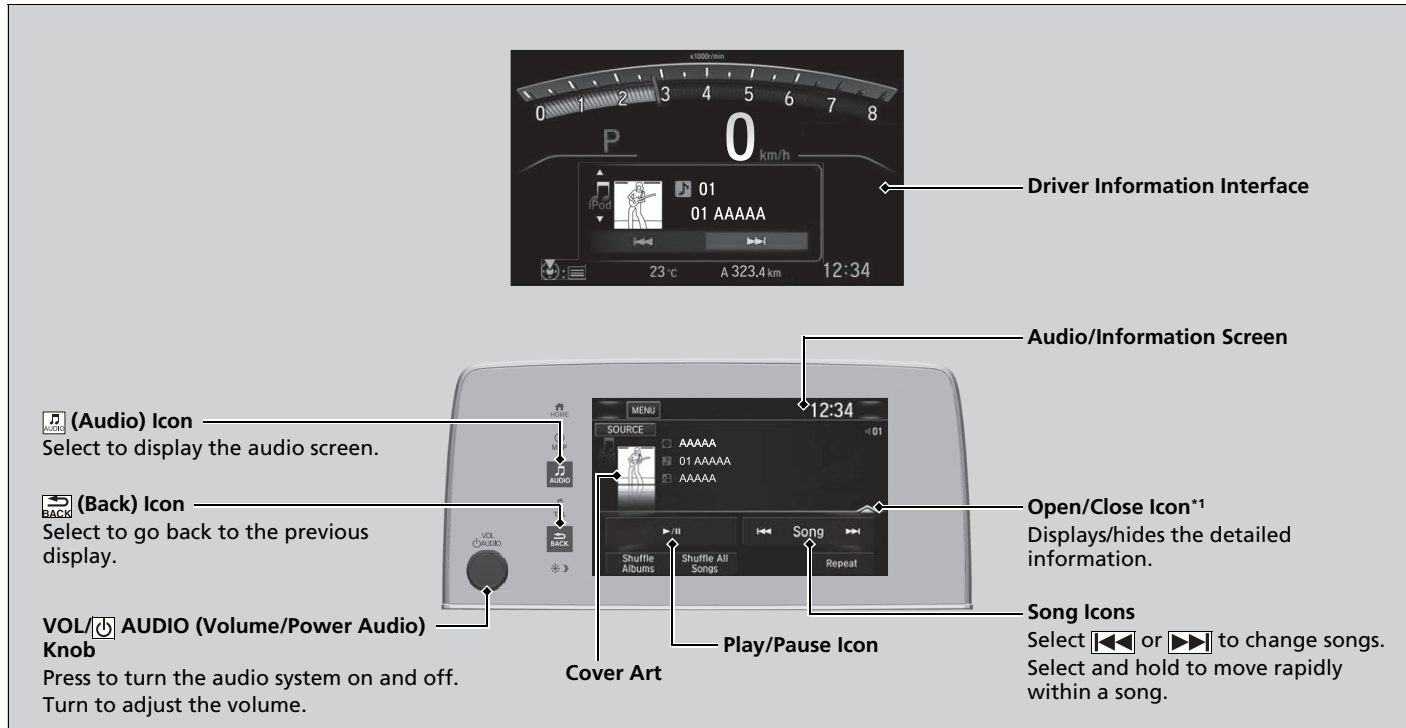

*1: Some or all of the lists may not be displayed.

How to Select a Song from the Music Search List

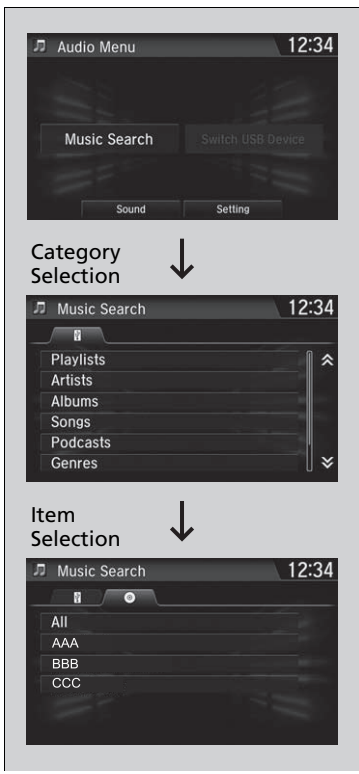

1. Select **MENU** and select **Music Search**.

2. Select the items on that menu.

▶▶ Playing an iPod

Available operating functions vary on models or versions. Some functions may not be available on the vehicle's audio system.

If there is a problem, you may see an error message on the audio/information screen.

▶▶ iPod/USB Flash Drive P. 398

If you operate any music app on your iPhone/iPod while the phone is connected to the audio system, you may no longer be able to operate the same app on the audio/information screen. Reconnect the device if necessary.

If an iPhone is connected via Apple CarPlay, the iPod/USB source is unavailable and audio files on the phone can only be played within Apple CarPlay.

How to Select a Play Mode

You can select shuffle and repeat modes when playing a file.

Select a play mode.

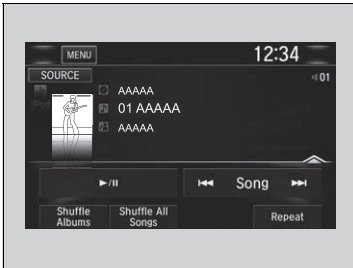

To turn off a play mode

Select the mode you want to turn off.

How to Select a Play Mode

Play Mode Menu Items

Shuffle Albums: Plays all available albums in a selected list (playlists, artists, albums, songs, podcasts, genres, composers, or audiobooks) in random order.

Shuffle All Songs: Plays all available files in a selected list (playlists, artists, albums, songs, podcasts, genres, composers, or audiobooks) in random order.

Repeat: Repeats the current track.

Song By Voice™ (SBV)*

Use SBV to search for and play music from your USB flash drive or iPod using voice commands.

■ To enable SBV

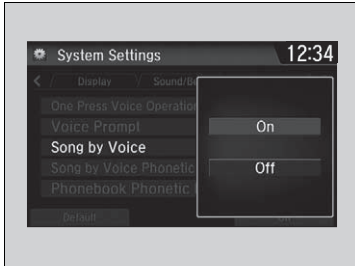

1. Select .
2. Select **Settings**.
3. Select **System**.
4. Select the **Voice Recog.** tab.
5. Select **Song by Voice**.
6. Select **On** or **Off**.



⌘ Song By Voice™ (SBV)*

Setting options:

- **On** (factory default): Song By Voice™ commands are available.
- **Off**: Disable the feature.

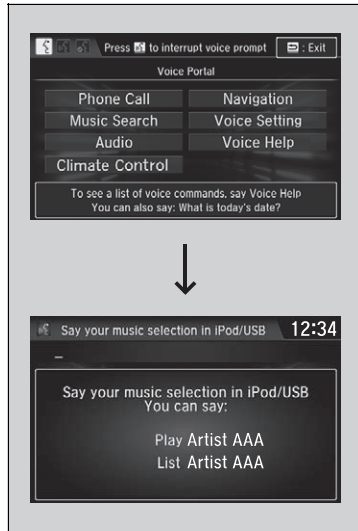
■ Searching for music using SBV



1. Set the **Song by Voice** setting to **On**.
2. Press the  (Talk) button and say "Music Search" to activate the SBV feature for the USB flash drive and iPod.
3. Then, say a next command.
 - ▶ Example 1: Say "(List) 'Artist A'" to view a list of songs by that artist. Select the desired song to start playing.
 - ▶ Example 2: Say "Play 'Artist A'" to start playing songs by that artist.
4. To cancel SBV, press the  (hang-up/back) button on the steering wheel. The selected song continues playing.

Once you have cancelled this mode, you need to press the  button and say "Music Search" again to re-activate this mode.

▶▶ Searching for music using SBV

Song By Voice™ Commands List

▶ **Song By Voice Commands** P. 360

NOTE:

Song By Voice™ commands are available for tracks stored on the USB flash drive or iPod.

You can add phonetic modifications of difficult words so that it is easier for SBV to recognize artists, songs, albums, and composers in voice commands.

▶ **Phonetic Modification** P. 372

SBV is not available when using Apple CarPlay. Use Siri Eyes Free instead.

Continued

■ Phonetic Modification

Add phonetic modifications of difficult or foreign words so that it is easier for SBV to recognize artists, songs, albums, and composers in voice commands when searching for music on the USB flash drive or iPod.





1. Select .
2. Select **Settings**.
3. Select **System**.
4. Select the **Voice Recog.** tab.
5. Select **Song by Voice Phonetic Modification**.
6. Select **New Modification**.
7. Select **USB** or **iPod**.

▶▶ Phonetic Modification

Song by Voice Phonetic Modification function is not available when **Song by Voice** is set to **Off**.

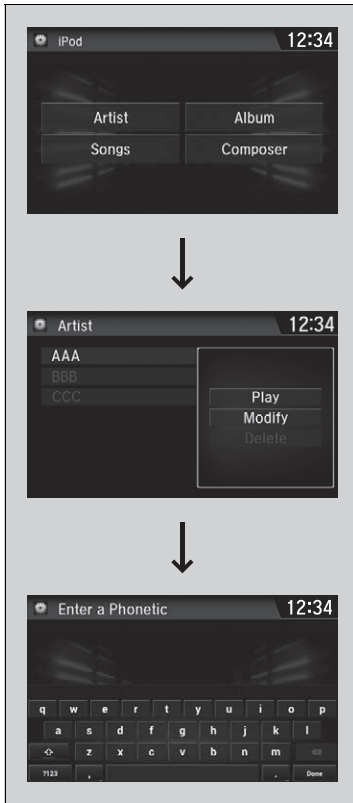
You can store up to 2,000 phonetic modification items.



8. Select the item to modify (e.g., **Artist**).
 - ▶ The list of the selected item appears on the screen.
9. Select an entry to modify.
 - ▶ The pop-up menu appears on the screen.
 - ▶ To listen to the current phonetic modification, select **Play**.
 - ▶ To delete the current phonetic modification, select **Delete**.
10. Select **Modify**.
11. Select the phonetic spelling you want to use (e.g., "Artist A") when prompted.
12. Select **OK**.
 - ▶ The artist "No Name" is phonetically modified to "Artist A." When in the SBV mode, you can press the  (Talk) button and use the voice command "Play 'Artist A'" to play songs by the artist "No Name."

Playing Aha™

Aha™ can be displayed and operated on the audio/information screen when your smartphone is connected to the audio system by Wi-Fi.

➔ **Wi-Fi Connection** P. 387

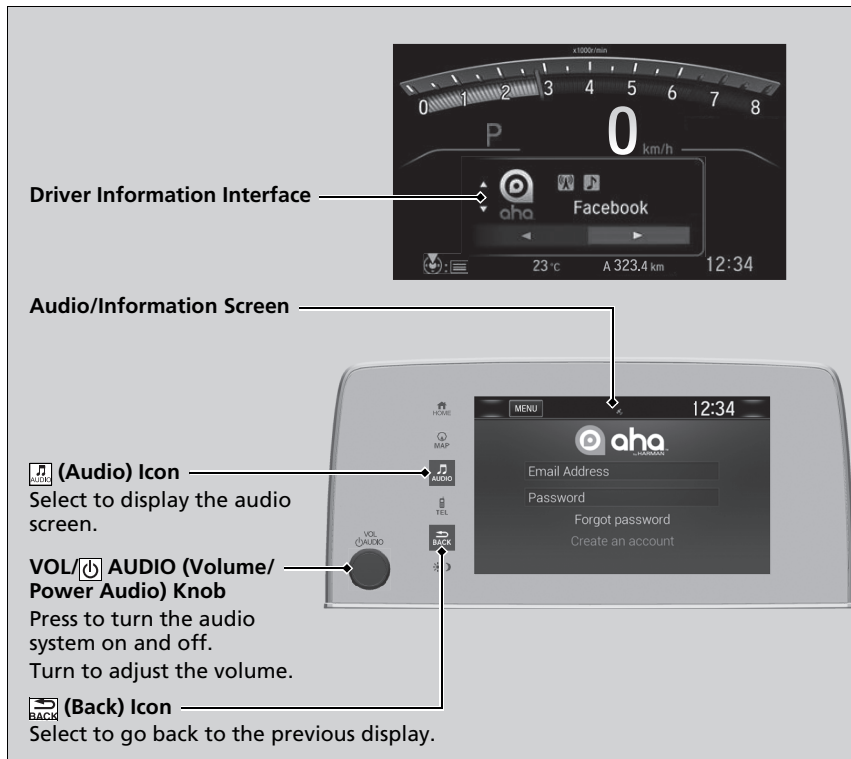

▶▶ Playing Aha™

Aha™ by Harman is a cloud-based service that organizes your favourite web content into live radio stations. You can access podcasts, internet radio, location-based services, and audio updates from social media sites.

Available operating functions vary on software versions. Some functions may not be available on the vehicle's audio system.

The menu items vary depending on the station you selected.

You must have a previously set up Aha™ account prior to using the service in your vehicle. Visit www.aharadio.com for more information.

You want to select another source, select **AUDIO** on the upper left of the screen. The source select screen will appear. Select the source you want.

If there is an active connection to Apple CarPlay or Android Auto, Aha™ can only be accessed when the phone is connected through Wi-Fi.

Playing a USB Flash Drive

Your audio system reads and plays sound and video files on a USB flash drive in either MP3, WMA, AAC*1, or MP4 format.

Connect your USB flash drive to the USB port, then select the USB mode.

🔧 **USB Port(s)** P. 299

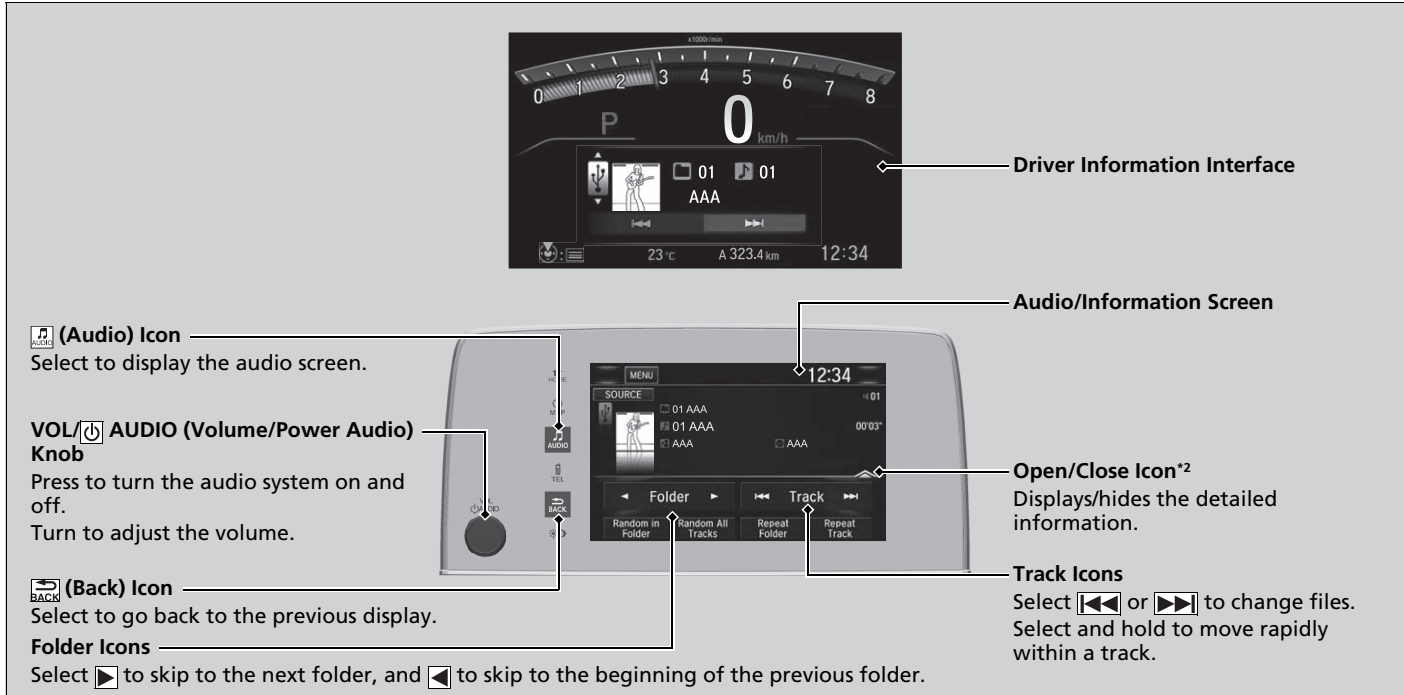

*1: Only AAC format files recorded with iTunes are playable on this unit.

*2: Some or all of the lists may not be displayed.

■ How to Select a File from the Music Search List

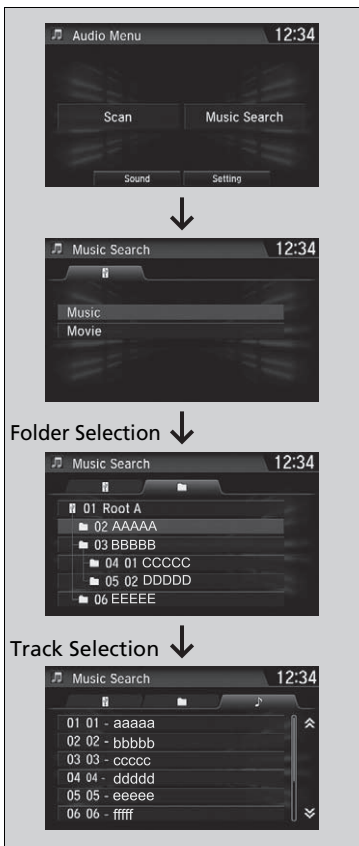

1. Select **MENU** and select **Music Search**.

2. Select **Music** or **Movie**.

3. Select a folder.

4. Select a track.

▶▶ Playing a USB Flash Drive

Use the recommended USB flash drives.

▶ **General Information on the Audio System**
P. 400

WMA files protected by digital rights management (DRM) cannot be played.

The audio system displays **Unplayable File**, then skips to the next file.

If there is a problem, you may see an error message on the audio/information screen.

▶ **iPod/USB Flash Drive** P. 398

How to Select a Play Mode

You can select scan, repeat, and random modes when playing a file.



■ Scan

1. Select **MENU**.
2. Select **Scan**.
3. Select a play mode.

■ Random/Repeat

Select a play mode.

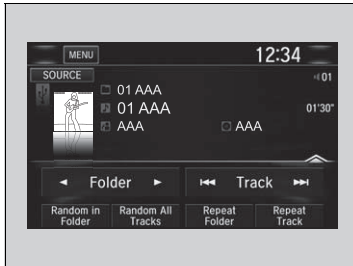

■ To turn off a play mode

To turn off Scan, select  or **Cancel**.

To turn off Random or Repeat, select the mode you want to turn off.

How to Select a Play Mode

Play Mode Menu Items

Scan

Scan Folders: Provides 10-second sampling of the first file in each of the main folders.

Scan Tracks: Provides 10-second sampling of all files in the current folder.

Random/Repeat

Random in Folder: Plays all files in the current folder in random order.

Random All Tracks: Plays all files in random order.

Repeat Folder: Repeats all files in the current folder.

Repeat Track: Repeats the current file.

When playing a video file:

Play/Pause: Plays or pauses the file.

Stop: Stops the file.

Playing *Bluetooth*® Audio

Your audio system allows you to listen to music from your *Bluetooth*-compatible phone.

This function is available when the phone is paired and connected to the vehicle's Hands-Free Telephone (HFT) system.

☑ **Phone Setup** P. 469

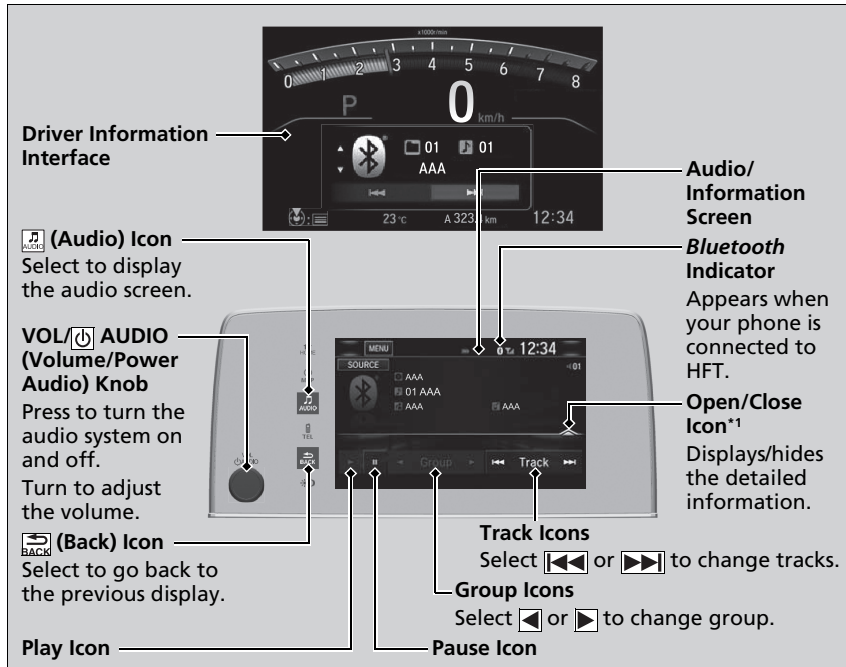

*1: Depending on the *Bluetooth*® device you connect, some or all of the lists may not be displayed.

▶▶ Playing *Bluetooth*® Audio

Not all *Bluetooth*-enabled phones with streaming audio capabilities are compatible.
To check if your phone is compatible, ask a dealer.

It may be illegal to perform some data device functions while driving.

Only one phone can be used with HFT at a time. When there are more than two paired phones in the vehicle, the first paired phone the system finds is automatically connected.

The connected phone for *Bluetooth*® Audio can be different.

If more than one phone is paired to the HFT system, there may be a delay before the system begins to play.

In some cases, the name of the artist, album, or track may not appear correctly.

Some functions may not be available on some devices.

If a phone is currently connected via Apple CarPlay or Android Auto, *Bluetooth*® Audio from that phone is unavailable. However, a second previously paired phone can stream *Bluetooth*® Audio by selecting **Connect** [🎵] from the **Bluetooth Device List** screen.

To Play *Bluetooth*® Audio Files

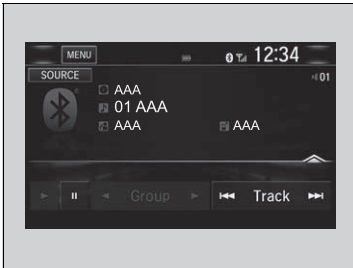

1. Make sure that your phone is paired and connected to the system.
 ▶ **Phone Setup** P. 469
2. Select the *Bluetooth*® Audio mode.

If the phone is not recognised, another HFT-compatible phone, which is not compatible for *Bluetooth*® Audio, may already be connected.

To pause or resume a file

Select the play icon or pause icon.

Searching for Music

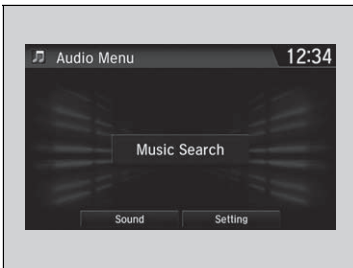

1. Select **MENU**.
2. Select **Music Search**.
3. Select a search category (e.g., Albums).
4. Select an item.
 ▶ The selection begins playing.

To Play *Bluetooth*® Audio Files

To play the audio files, you may need to operate your phone. If so, follow the phone maker's operating instructions.

Switching to another mode pauses the music playing from your phone.

You can change the connected phone in the *Bluetooth*® settings on the **Audio Menu** screen by the following procedure.

1. Select **MENU**.
2. Select **Setting**.

Searching for Music

Depending on the *Bluetooth*® device you connect, some or all of the lists may not be displayed.

Playing a Video Using the HDMI™

Your audio system allows you to play videos from an HDMI-compatible device. Connect the device, using an HDMI™ cable, then select the HDMI™ mode.

➔ **HDMI™ Port*** P. 300

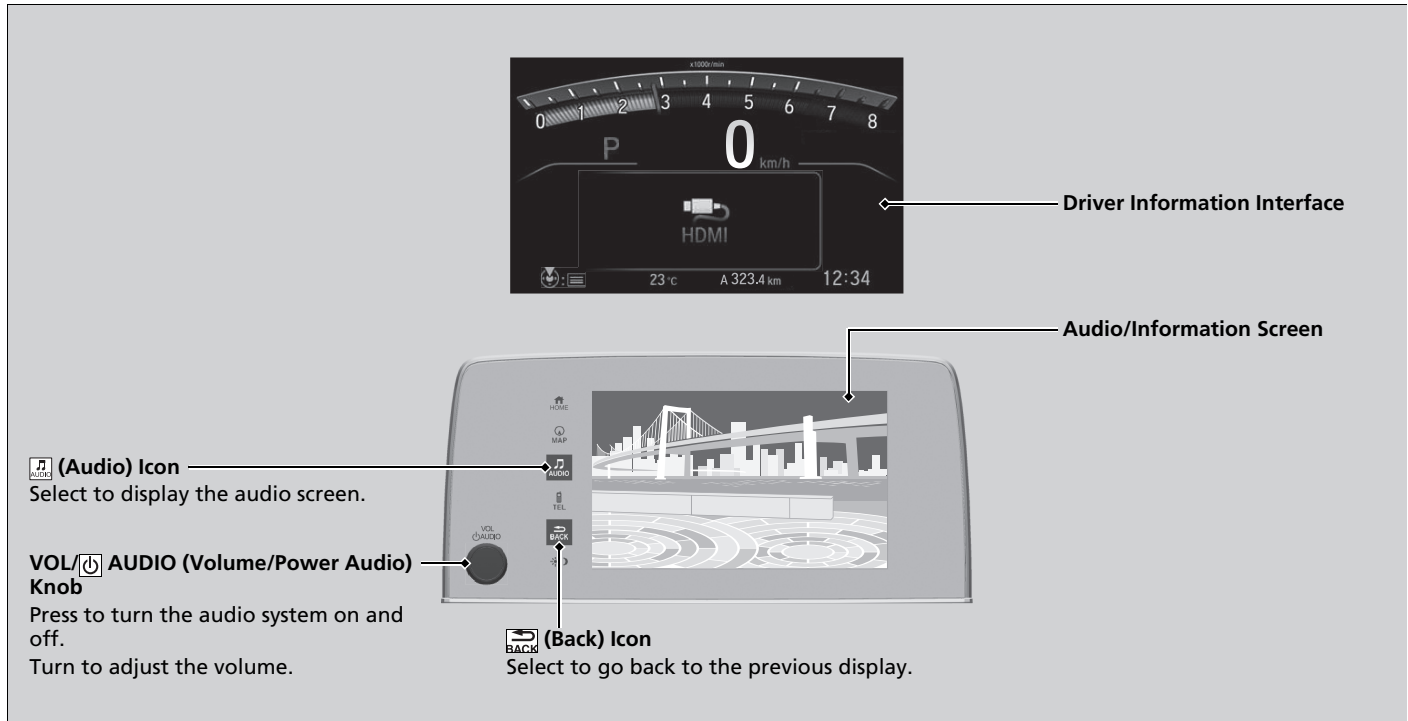

Changing the Screen Aspect



1. Select .
2. Select **Settings**.
3. Select **Audio**.
4. Select the **Video** tab.
5. Select **Aspect Ratio Adjustment**.
6. Select the setting you want.
7. Select **OK**.

▶▶ Playing a Video Using the HDMI™

This feature is limited while driving. To play videos, stop your vehicle and apply the parking brake.

On Board Apps

Honda Connect has the capability of On Board Apps which may be created by Honda or by 3rd parties. Apps may be already installed or can be downloaded through Honda App Centre. Some Apps require internet access which can be established by Wi-Fi Connection.

📶 **Wi-Fi Connection** P. 387

Please visit the below web address for further information:

<https://ivhs.os.ixonos.com/honda/category/carApps.html>

📺 On Board Apps

Even if you change **Background Colour** on the **System Settings** screen, it will not be reflected on the Honda App Centre screen.



App Centre Icon

Honda App Centre provides access to a variety of App related services.

- Using the Display Audio system while driving can take your attention away from the road, causing a crash in which you could be seriously injured or killed. Only operate system controls when the conditions permit you to safely do so. **Please always adhere to the laws of the territory when operating this device.**
- Applications on the head unit are subject to change at anytime. This may mean that they are not available or operate differently. Honda shall not be liable to you in such instances.
- Applications available on the device may be provided by parties other than Honda to which 3rd party software licences and charges may apply.
- Data usage and roaming charges may result in using applications on the device in conjunction with your mobile phone and Honda is not liable for any costs you might incur from such use. Honda recommends you consult your mobile phone network provider in advance.
- Downloading applications from the Honda App Centre will be subject to Terms and Conditions which can be found at: <https://ivhs.os.ixonos.com/honda/category/carApps.html>, and may also incur charges.

Smartphone Connection

Some of your smartphone apps can be displayed and operated on the audio/information screen when the phone is connected to the audio system. You can connect your phone using a cable.

📌 **Connecting Your iPhone** P. 385

📌 **Connecting Your Smartphone** P. 386

Smartphone Connection

Park in a safe place before connecting your phone and while operating the displayed apps.

Not all phones are compatible with the system. The system does not display all the available apps on your smartphone, and some apps need to be preinstalled. Ask a dealer for details.

You need to switch the *Bluetooth*® connection to your smartphone if another electronic device is connected.

📌 **To change the currently paired phone**
P. 470

The following may vary by phone type:

- How to connect a smartphone to the system.
- Apps that can be operated on the screen.
- Display response time/update time

We do not support every app operation on the audio system.

Ask the app provider for any queries on the app's features.

Do not get drawn into the display while operating a vehicle.

To use smartphone connection, you need to first pair your smartphone to the audio system via *Bluetooth*®.

➤ **Phone Setup** P. 469

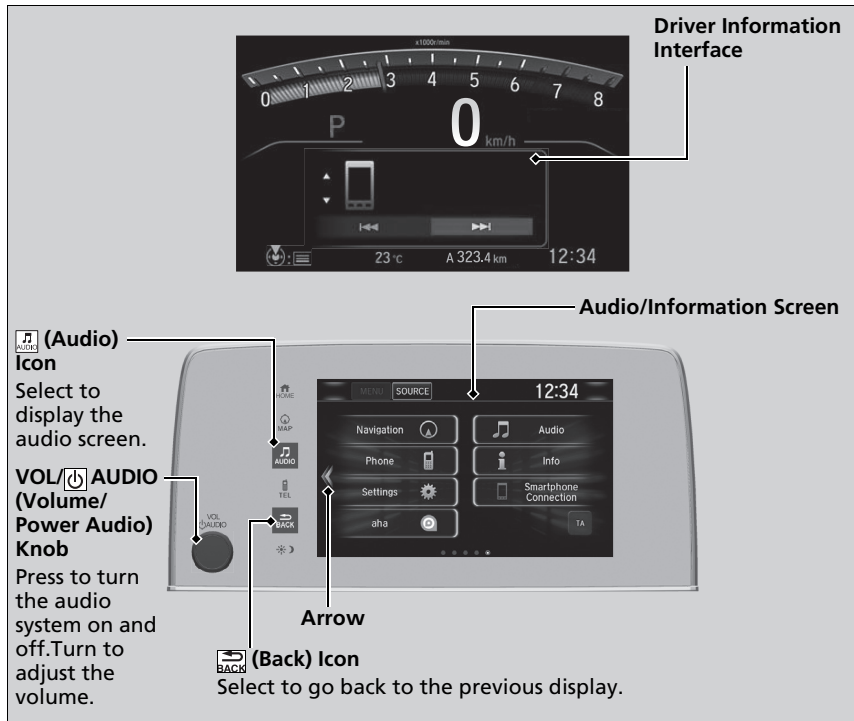

Connecting Your iPhone

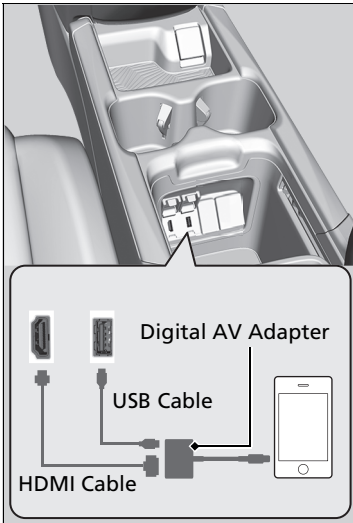

1. Connect your phone to the audio system via *Bluetooth*®.
 - ▶ **Phone Setup** P. 469
2. Plug in the digital AV adapter to the HDMI™ port.
3. Connect the digital AV adapter to your iPhone.
 - ▶ Wait until an arrow appears on the home screen.
4. Select the arrow to display the available smartphone apps on the audio/information screen.
 - ▶ You may need to operate from the phone.
5. Select an app you want to operate from the audio/information screen.
 - ▶ To go back to the previous screen, select



Connecting Your iPhone

Make sure to plug in the digital AV adapter to the HDMI™ port first. If not, smartphone connection may not work properly.

To recharge your phone, connect it to the USB port, too.

Contact a dealer for the digital AV adapter or HDMI™ purchasing information.

■ Connecting Your Smartphone

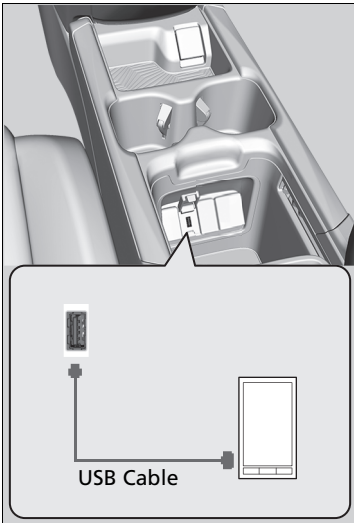

1. Connect your phone to the audio system via *Bluetooth*®.
 - ▶ **Phone Setup** P. 469
2. Plug in your phone to the USB jack.
 - ▶ You may need to operate from the phone.
 - ▶ Wait until an arrow appears on the home screen.
3. Select the arrow to display the available smartphone apps on the audio/information screen.
4. Select an app you want to operate from the audio/information screen.
 - ▶ To go back to the previous screen, select



☒ Connecting Your Smartphone

The phone is rechargeable while being connected to the USB jack. However, if the phone is overloaded with many operational tasks, the battery level may get lowered.

Wi-Fi Connection

You can connect the Display Audio to the Internet using Wi-Fi and browse websites or use online services on the audio/information screen. If your phone has wireless hotspot capabilities, the system can be tethered to the phone. Use the following steps to setup.

Wi-Fi mode (setting for the first time)



1. Select .
2. Select **Settings**.
3. Select **Bluetooth / Wi-Fi**.
4. Select the **Wi-Fi** tab.
5. Select **Wi-Fi On/Off Status**, then select **On**.
6. Select **Yes**.
7. Select **Wi-Fi Device List**.
 - ▶ Make sure your phone's Wi-Fi setting is in access point (tethering) mode.
 - ▶ Select the phone you want to connect to the system.
 - ▶ If you do not find the phone you want to connect in the list, select **Scan**.

Wi-Fi mode (setting for the first time)

You cannot go through the setting procedure while a vehicle is moving. Park in a safe place to setup the Wi-Fi connection.

Some mobile phone carriers charge for tethering and smartphone data use. Check your phone's data subscription package.

Check your phone manual to find out if the phone has Wi-Fi connectivity.

You can confirm whether Wi-Fi connection is on or off with the  icon on the **Wi-Fi Device List** screen. Network speed will not be displayed on this screen.

Continued

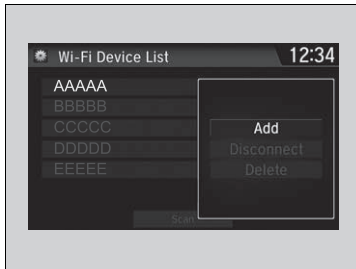

8. Select **Add**.

- ▶ If needed, enter a password for your phone and select **Done**.
- ▶ When the connection is successful, the  icon is displayed on the top of the screen.

9. Select  to go back to the home screen.

▶▶ Wi-Fi mode (after the initial setting has been made)

iPhone users

You may need to go through an initial setup for Wi-Fi connection again after you boot your phone.

■ **Wi-Fi mode (after the initial setting has been made)**

Make sure your phone's Wi-Fi setting is in access point (tethering) mode.

Siri Eyes Free

You can talk to Siri using the  (Talk) button on the steering wheel when your iPhone is paired to the Hands-Free Telephone (HFT) system.

 **Phone Setup** P. 469

▶ Siri Eyes Free

Siri is a trademark of Apple Inc.

Check Apple Inc. website for features available for Siri.

We recommend against using Siri other than in Siri Eyes Free while operating a vehicle.

▶ Using Siri Eyes Free

Some commands work only on specific phone features or apps.

Using Siri Eyes Free

(Hang-up/back) Button

Press to deactivate Siri Eyes Free.

(Talk) Button

Press and hold until the display changes as shown.

While in Siri Eyes Free:
The display remains the same.
No feedback or commands appear.



Appears when Siri is activated in Siri Eyes Free

Apple CarPlay

If you connect an Apple CarPlay-compatible iPhone to the system via the 1.5A USB port, you can use the audio/information screen, instead of the iPhone display, to make a phone call, listen to music, view maps (navigation), and access messages.

➤ **USB Port(s)** P. 299

Apple CarPlay Menu

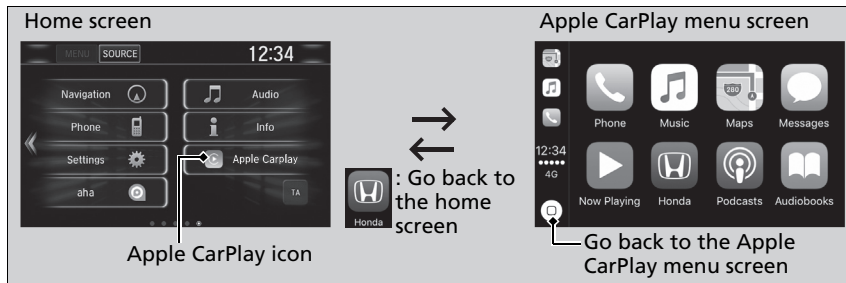

■ Phone

Access the contact list, make phone calls, or listen to voice mail.

■ Messages

Check and reply to text messages, or have messages read to you.

■ Music

Play music stored on your iPhone.

Apple CarPlay

Only iPhone 5 or newer versions with iOS 8.4 or later are compatible with Apple CarPlay.

Park in a safe place before connecting your iPhone to Apple CarPlay and when launching any compatible apps.

To use Apple CarPlay, connect the USB cable to the 1.5A USB port. Other USB ports will not enable Apple CarPlay operation.

➤ **USB Port(s)** P. 299

To directly access the Apple CarPlay phone function, select **Phone** on the home screen. While connected to Apple CarPlay, calls are only made through Apple CarPlay. If you want to make a call with the Hands-Free Telephone system, turn Apple CarPlay OFF or detach the USB cable from your iPhone.

➤ **Setting Up Apple CarPlay** P. 392

When your iPhone is connected to Apple CarPlay, it is not possible to use the *Bluetooth*® Audio or the Hands-Free Telephone system. However, other previously paired phones can stream audio via *Bluetooth*® while Apple CarPlay is connected.

➤ **Phone Setup** P. 469

■ Maps

Display Apple Maps and use the navigation function just as you would on your iPhone.

Models with navigation system

Only one navigation system (pre-installed navigation or Apple CarPlay) can give directions at a time. When you are using one system, directions to any prior destination set on the other system will be cancelled, and the system you are currently using will direct you to your destination.

▶▶ Apple CarPlay

For details on countries and regions where Apple CarPlay is available, as well as information pertaining to function, refer to the Apple homepage.

Apple CarPlay Operating Requirements & Limitations

Apple CarPlay requires a compatible iPhone with an active cellular connection and data plan. Your carrier's rate plans will apply.

Changes in operating systems, hardware, software, and other technology integral to providing Apple CarPlay functionality, as well as new or revised governmental regulations, may result in a decrease or cessation of Apple CarPlay functionality and services. Honda cannot and does not provide any warranty or guarantee of future Apple CarPlay performance or functionality.

It is possible to use 3rd party apps if they are compatible with Apple CarPlay. Refer to the Apple homepage for information on compatible apps.

■ Setting Up Apple CarPlay

After you have connected your iPhone to the system via the 1.5A USB port, use the following procedure to set up Apple CarPlay. Use of Apple CarPlay will result in the transmission of certain user and vehicle information (such as vehicle location, speed, and status) to your iPhone to enhance the Apple CarPlay experience. You will need to consent to the sharing of this information on the Display Audio Screen.

■ Enabling Apple CarPlay

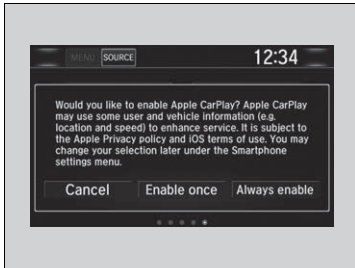

Enable once: Allows only once. (Prompt shows again next time.)

Always enable: Allows anytime. (Prompt does not show again.)

Cancel: Does not allow this consent.

You may change the consent settings under the **Smartphone** settings menu.

▶▶ Setting Up Apple CarPlay

You can also use the method below to set up Apple CarPlay:

Select HOME→Settings→Smartphone→Apple CarPlay

Use of user and vehicle information

The use and handling of user and vehicle information transmitted to/from your iPhone by Apple CarPlay is governed by the Apple iOS terms and conditions and Apple's Privacy Policy.

■ Operating Apple CarPlay with Siri

Press and hold the  (Talk) button to activate Siri.

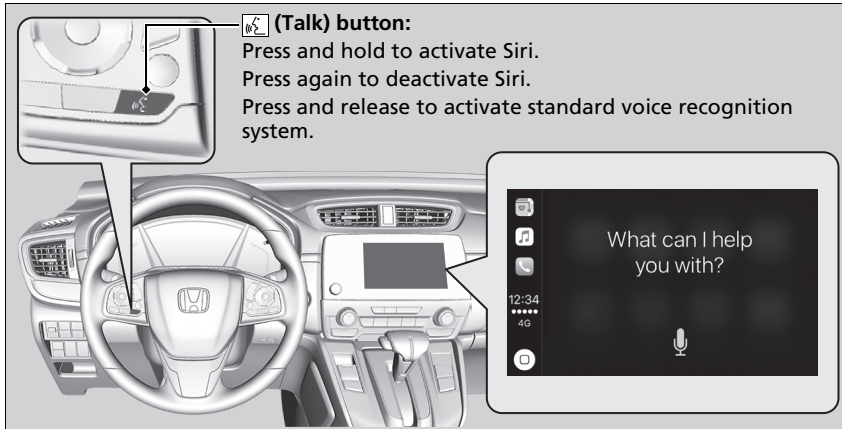

☒ Operating Apple CarPlay with Siri

Below are examples of questions and commands for Siri.

- What movies are playing today?
- Call dad at work.
- What song is this?
- How's the weather tomorrow?
- Read my latest email.

For more information, please visit www.apple.com/ios/siri.

Android Auto

When you connect an Android phone to the Display Audio system via the 1.5A USB port, Android Auto is automatically initiated. When connected via Android Auto, you can use the audio/information screen to access the Phone, Google Maps (Navigation), Google Play Music, and Google Now functions. When you first use Android Auto, a tutorial will appear on the screen.

We recommend that you complete this tutorial while safely parked before using Android Auto.

➤ **USB Port(s)** P. 299

➤ **Auto Pairing Connection** P. 396

NOTE:

Android Auto may not be available in your country or region. For details about Android Auto, please refer to the Google support site.

Android Auto

To use Android Auto, you need to download the Android Auto app from Google Play to your smartphone.

Only Android 5.0 (Lollipop) or later versions are compatible with Android Auto. Bluetooth A2DP cannot be used with Android Auto phone.

Park in a safe place before connecting your Android phone to Android Auto and when launching any compatible apps.

To use Android Auto, connect the USB cable to the 1.5A USB port. Other USB ports will not enable Android Auto operation.

➤ **USB Port(s)** P. 299

When your Android phone is connected to Android Auto, it is not possible to use the *Bluetooth*® Audio. However, other previously paired phones can stream audio via *Bluetooth*® while Android Auto is connected.

➤ **Phone Setup** P. 469

Android Auto Menu

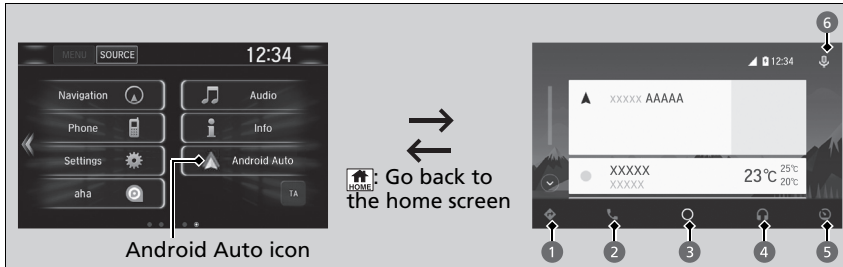

1 Maps (Navigation)

Display Google Maps and use the navigation function just as you would with your Android phone. When the vehicle is in motion, it is not possible to make keyboard entries. Stop the vehicle in a safe location to undertake a search or provide other inputs.

Models with navigation system

Only one navigation system (pre-installed navigation or Android Auto) can give directions at a time. When you are using one system, directions to any prior destination set on the other system will be cancelled, and the system you are currently using will direct you to your destination.

The audio/Information screen shows you turn-by-turn driving directions to your destination.

2 Phone (Communication) Make and receive phone calls as well as listen to voicemail.

3 Google Now (Home screen)

Display useful information organized by Android Auto into simple cards that appear just when they're needed.

Android Auto

For details on countries and regions where Android Auto is available, as well as information pertaining to function, refer to the Android Auto homepage.

Android Auto Operating Requirements & Limitations

Android Auto requires a compatible Android phone with an active cellular connection and data plan. Your carrier's rate plans will apply.

Changes in operating systems, hardware, software, and other technology integral to providing Android Auto functionality, as well as new or revised governmental regulations, may result in a decrease or cessation of Android Auto functionality and services. Honda cannot and does not provide any warranty or guarantee of future Android Auto performance or functionality.

It is possible to use 3rd party apps if they are compatible with Android Auto. Refer to the Android Auto homepage for information on compatible apps.

4 Music and audio

Play Google Play Music and music apps that are compatible with Android Auto. To switch between music apps, press this icon.

5 Go back to the Home Screen.

6 Voice

Operate Android Auto with your voice.

Auto Pairing Connection

When you connect an Android phone to the unit via the 1.5A USB port, Android Auto is automatically initiated.

■ Enabling Android Auto

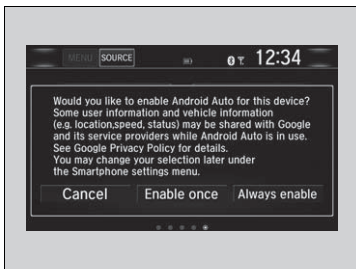

Enable once: Allows only once. (Prompt shows again next time.)

Always enable: Allows anytime. (Prompt does not show again.)

Cancel: Does not allow this consent.

You may change the consent settings under the **Smartphone** settings menu.

▶▶ Enabling Android Auto

Only initialize Android Auto when you safely parked. When Android Auto first detects your phone, you will need to set up your phone so that auto pairing is possible. Refer to the instruction manual that came with your phone.

You can use the method below to change Android Auto settings after you have completed the initial setup:
Select HOME→Settings→Smartphone→Android Auto

Use of user and vehicle information

The use and handling of user and vehicle information transmitted to/from your phone by Android Auto is governed by the Google's Privacy Policy.

■ Operating Android Auto with Voice Recognition

Press and hold the  (Talk) button to operate Android Auto with your voice.

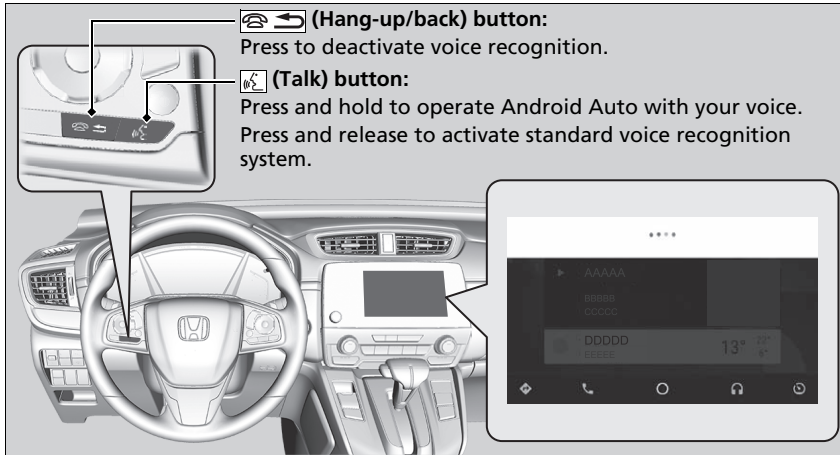

☒ Operating Android Auto with Voice Recognition

Below are examples of commands you can give with voice recognition:

- Reply to text.
- Call my wife.
- Navigate to Honda.
- Play my music.
- Send a text message to my wife.
- Call flower shop.

For more information, please refer to the Android Auto homepage.

You can also activate the voice recognition function by pressing the  icon in the upper-right corner of the screen.

iPod/USB Flash Drive

If an error occurs while playing an iPod or USB flash drive, you may see the following error messages. If you cannot clear the error message, contact a dealer.

Error Message	Solution
USB error ^{*1, *2}	Appears when there is a problem with the audio system. Check if the device is compatible with the audio system.
A charging error has occurred with the connected USB device. When safe please check the compatibility of the device and USB cable and try again. ^{*2}	Appears when an incompatible device is connected. Disconnect the device. Then turn the audio system off, and turn it on again. Do not reconnect the device that caused the error.
Unsupported ver ^{*1} Unsupported Version ^{*2}	Appears when an unsupported iPod is connected. If it appears when a supported iPod is connected, update the iPod software to the newer version.
Connect retry ^{*1, *2}	Appears when the system does not acknowledge the iPod. Reconnect the iPod.
Unplayable File ^{*1, *2}	Appears when the files in the USB flash drive are copyright protected or an unsupported format. This error message appears for about three seconds, then plays the next song.
No song ^{*1} No Data ^{*2}	iPod Appears when the iPod is empty. USB flash drive Appears when the USB flash drive is empty or there are no MP3, WMA, AAC, WAV*, or MP4* files in the USB flash drive. iPod and USB flash drive Check that compatible files are stored on the device.

*1:Models with colour audio system

*2:Models with Display Audio

Error Message	Solution
Unsupported *1, *2	Appears when an unsupported device is connected. If it appears when a supported device is connected, reconnect the device.
Device no response *1	Appears when the system does not communicate with a connected device. If it appears when a device is connected, contact your place of device purchase.
HUB Unsupported *1	Appears when only a HUB is connected. If it appears, connect a USB flash drive to the HUB.

*1:Models with colour audio system

*2:Models with Display Audio

Models with Display Audio

Android/Apps

If an error occurs while using the audio system or apps, you may see the following error messages. If you cannot clear the error message, contact a dealer.

Error Message*1	Solution
Unfortunately, **** has stopped.	Error has occurred within app, select OK on the screen to close the app.
**** is not responding. Would you like to close it?	App is not responding. Select Wait if you can wait for a response from app a little longer. If it does not respond even if you keep waiting, select OK to close the app and start it up. If the error message continues, perform Factory Data Reset .  Defaulting All the Settings P. 440

*1:****part is variable characters, and will change depending upon where an error occurs.

Compatible iPod, iPhone, and USB Flash Drives

iPod and iPhone Model Compatibility

Model
iPod (5th generation)
iPod classic 80GB/160GB (launch in 2007)
iPod classic 120GB (launch in 2008)
iPod classic 160GB (launch in 2009)
iPod nano (1st to 7th generation) released between 2005 and 2012
iPod touch (1st to 5th generation) released between 2007 and 2012
iPhone 3G/iPhone 3GS/iPhone 4/iPhone 4S/iPhone 5/iPhone 5c ^{*1} /iPhone 5s ^{*1}

*1: Models with Display Audio

USB Flash Drives

- A USB flash drive of 256 MB or higher is recommended.
- Some digital audio players may not be compatible.
- Some USB flash drives (e.g., a device with security lockout) may not work.
- Some software files may not allow for audio play or text data display.
- Some versions of MP3, WMA, AAC, WAV*, or MP4* formats may be unsupported.

iPod and iPhone Model Compatibility

This system may not work with all software versions of these devices.

USB Flash Drives

Files on the USB flash drive are played in their stored order. This order may be different from the order displayed on your PC or device.

Recommended Devices *	
Media	USB Flash Drive
Profile (MP4 version)	Baseline Level 3 (MPEG4-AVC), Simple Level 5 (MPEG4)
File extension (MP4 version)	.mp4/.m4v
Compatible audio codec	AAC MP3
Compatible video codec	MPEG4-AVC (H.264) MPEG4 (ISO/IEC 14496 Part.2)
Bit rate	10 Mbps (MPEG4-AVC) 8 Mbps (MPEG4)
Maximum image	720 x 576 pixels

* Not available on all models

Models with Display Audio

Legal Information on Apple CarPlay/Android Auto

OWNER'S MANUAL LICENSE/LIABILITY STATEMENTS

USE OF APPLE CARPLAY IS SUBJECT TO YOUR AGREEMENT TO THE CARPLAY TERMS OF USE, WHICH ARE INCLUDED AS PART OF THE APPLE iOS TERMS OF USE. IN SUMMARY, THE CARPLAY TERMS OF USE DISCLAIM APPLE AND ITS SERVICE PROVIDERS' LIABILITY IF THE SERVICES FAIL TO PERFORM CORRECTLY OR ARE DISCONTINUED, STRICTLY LIMIT APPLE AND ITS SERVICE PROVIDERS' OTHER LIABILITIES, DESCRIBE THE KINDS OF USER INFORMATION (INCLUDING, FOR EXAMPLE, VEHICLE LOCATION, VEHICLE SPEED, AND VEHICLE STATUS) BEING GATHERED AND STORED BY APPLE AND ITS SERVICE PROVIDERS, AND DISCLOSE CERTAIN POSSIBLE RISKS ASSOCIATED WITH THE USE OF CARPLAY, INCLUDING THE POTENTIAL FOR DRIVER DISTRACTION. SEE APPLE'S PRIVACY POLICY FOR DETAILS REGARDING APPLE'S USE AND HANDLING OF DATA UPLOADED BY CARPLAY.

USE OF ANDROID AUTO IS SUBJECT TO YOUR AGREEMENT TO THE ANDROID AUTO TERMS OF USE WHICH MUST BE AGREED TO WHEN THE ANDROID AUTO APPLICATION IS DOWNLOADED TO YOUR ANDROID PHONE. IN SUMMARY, THE ANDROID AUTO TERMS OF USE DISCLAIM GOOGLE AND ITS SERVICE PROVIDERS' LIABILITY IF THE SERVICES FAIL TO PERFORM CORRECTLY OR ARE DISCONTINUED, STRICTLY LIMIT GOOGLE AND ITS SERVICE PROVIDERS' OTHER LIABILITIES, DESCRIBE THE KINDS OF USER INFORMATION (INCLUDING, FOR EXAMPLE, VEHICLE LOCATION, VEHICLE SPEED, AND VEHICLE STATUS) BEING GATHERED AND STORED BY GOOGLE AND ITS SERVICE PROVIDERS, AND DISCLOSE CERTAIN POSSIBLE RISKS ASSOCIATED WITH THE USE OF ANDROID AUTO, INCLUDING THE POTENTIAL FOR DRIVER DISTRACTION. SEE GOOGLE'S PRIVACY POLICY FOR DETAILS REGARDING GOOGLE'S USE AND HANDLING OF DATA UPLOADED BY ANDROID AUTO.

DISCLAIMER OF WARRANTIES; LIMITATION ON LIABILITY



YOU EXPRESSLY ACKNOWLEDGE AND AGREE THAT USE OF APPLE CARPLAY OR ANDROID AUTO (“THE APPLICATIONS”) IS AT YOUR SOLE RISK AND THAT THE ENTIRE RISK AS TO SATISFACTORY QUALITY, PERFORMANCE, ACCURACY AND EFFORT IS WITH YOU TO THE MAXIMUM EXTENT PERMITTED BY APPLICABLE LAW, AND THAT THE APPLICATIONS AND INFORMATION ON THE APPLICATIONS IS PROVIDED “AS IS” AND “AS AVAILABLE,” WITH ALL FAULTS AND WITHOUT WARRANTY OF ANY KIND, AND HONDA HEREBY DISCLAIMS ALL WARRANTIES AND CONDITIONS WITH RESPECT TO THE APPLICATIONS AND INFORMATION ON THE APPLICATIONS, EITHER EXPRESS, IMPLIED OR STATUTORY, INCLUDING, BUT NOT LIMITED TO, THE IMPLIED WARRANTIES AND/OR CONDITIONS OF MERCHANTABILITY, SATISFACTORY QUALITY, FITNESS FOR A PARTICULAR PURPOSE, ACCURACY, QUIET ENJOYMENT, AND NON-INFRINGEMENT OF THIRD PARTY RIGHTS. NO ORAL OR WRITTEN INFORMATION OR ADVICE GIVEN BY HONDA OR AN AUTHORISED REPRESENTATIVE SHALL CREATE A WARRANTY. AS EXAMPLES, AND WITHOUT LIMITATION, HONDA DISCLAIMS ANY WARRANTY REGARDING THE ACCURACY OF DATA PROVIDED BY THE APPLICATIONS, SUCH AS THE ACCURACY OF DIRECTIONS, ESTIMATED TRAVEL TIME, SPEED LIMITS, ROAD CONDITIONS, NEWS, WEATHER, TRAFFIC, OR OTHER CONTENT PROVIDED BY APPLE, GOOGLE, THEIR AFFILIATES, OR THIRD PARTY PROVIDERS; HONDA DOES NOT GUARANTEE AGAINST LOSS OF APPLICATION DATA, WHICH MAY BE LOST AT ANY TIME; HONDA DOES NOT GUARANTEE THAT THE APPLICATIONS OR ANY SERVICES PROVIDED THROUGH THEM WILL BE PROVIDED AT ALL TIMES OR THAT ANY OR ALL SERVICES WILL BE AVAILABLE AT ANY PARTICULAR TIME OR LOCATION. FOR EXAMPLE, SERVICES MAY BE SUSPENDED OR INTERRUPTED WITHOUT NOTICE FOR REPAIR, MAINTENANCE, SECURITY FIXES, UPDATES, ETC., SERVICES MAY BE UNAVAILABLE IN YOUR AREA OR LOCATION, ETC. IN ADDITION, YOU UNDERSTAND THAT CHANGES IN THIRD PARTY TECHNOLOGY OR GOVERNMENT REGULATION MAY RENDER THE SERVICES AND/OR APPLICATIONS OBSOLETE AND/OR UNUSABLE.

TO THE EXTENT NOT PROHIBITED BY LAW, IN NO EVENT SHALL HONDA OR ITS AFFILIATES BE LIABLE FOR PERSONAL INJURY, OR ANY INCIDENTAL, SPECIAL, INDIRECT OR CONSEQUENTIAL DAMAGES WHATSOEVER, INCLUDING, WITHOUT LIMITATION, DAMAGES FOR LOSS OF PROFITS, CORRUPTION OR LOSS OF DATA, FAILURE TO TRANSMIT OR RECEIVE ANY DATA, BUSINESS INTERRUPTION OR ANY OTHER COMMERCIAL DAMAGES OR LOSSES, ARISING OUT OF OR RELATED TO THE APPLICATIONS OR YOUR USE OF OR INABILITY TO USE THE APPLICATIONS OR INFORMATION ON THE APPLICATIONS, HOWEVER CAUSED, REGARDLESS OF THE THEORY OF LIABILITY (CONTRACT, TORT OR OTHERWISE) AND EVEN IF HONDA WERE ADVISED OF THE POSSIBILITY OF SUCH DAMAGES. SOME REGIONS AND JURISDICTIONS MAY DISALLOW THE EXCLUSION OR LIMITATION OF LIABILITY FOR DAMAGES, SO THESE LIMITATIONS AND EXCLUSIONS MAY NOT APPLY TO YOU. THE FOREGOING LIMITATIONS WILL APPLY EVEN IF THE ABOVE STATED REMEDY FAILS OF ITS ESSENTIAL PURPOSE.

About Open Source Licences

To see the open source Licence information, follow these steps.

Models with colour audio system

1. Press the **MENU/CLOCK** button.
2. Rotate  to select **Settings**, then press .
3. Rotate  to select **License**, then press .

Models with Display Audio

1. Select .
2. Select **Settings**.
3. Select **System**.
4. Select the **Others** tab.
5. Select **Detailed Information**.
6. Select **About device**.
7. Select **Legal information**.
8. Select **Open-source licences**.

Models with eCall Unit

Free/Open Source Software Information

This product contains Free/Open Source Software (FOSS).

The license information and/or the source code of such FOSS can be found at the following URL.

<https://www.denso.com/global/en/opensource/tcu/honda/>

▶▶ About Open Source Licences

LICENCE: Copyright © 2001 Bob Trower, Trantor Standard Systems Inc.

Permission is hereby granted, free of charge, to any person obtaining a copy of this software and associated documentation files (the "Software"), to deal in the Software without restriction, including without limitation the rights to use, copy, modify, merge, publish, distribute, sublicense, and/or sell copies of the Software, and to permit persons to whom the Software is furnished to do so, subject to the following conditions:

The above copyright notice and this permission notice shall be included in all copies or substantial portions of the Software.



THE SOFTWARE IS PROVIDED "AS IS", WITHOUT WARRANTY OF ANY KIND, EXPRESS OR IMPLIED, INCLUDING BUT NOT LIMITED TO THE WARRANTIES OF MERCHANTABILITY, FITNESS FOR A PARTICULAR PURPOSE AND NONINFRINGEMENT. IN NO EVENT SHALL THE AUTHORS OR COPYRIGHT HOLDERS BE LIABLE FOR ANY CLAIM, DAMAGES OR OTHER LIABILITY, WHETHER IN AN ACTION OF CONTRACT, TORT OR OTHERWISE, ARISING FROM, OUT OF OR IN CONNECTION WITH THE SOFTWARE OR THE USE OR OTHER DEALINGS IN THE SOFTWARE.

Customized Features

Models with colour audio system

Use the audio/information screen to customize certain features.

■ How to customize

While the vehicle is at a complete stop with the ignition switch in ON *1, press the **MENU/CLOCK** button, then select **Settings**. To customize the phone settings, press the  button, then select **Phone setup**.

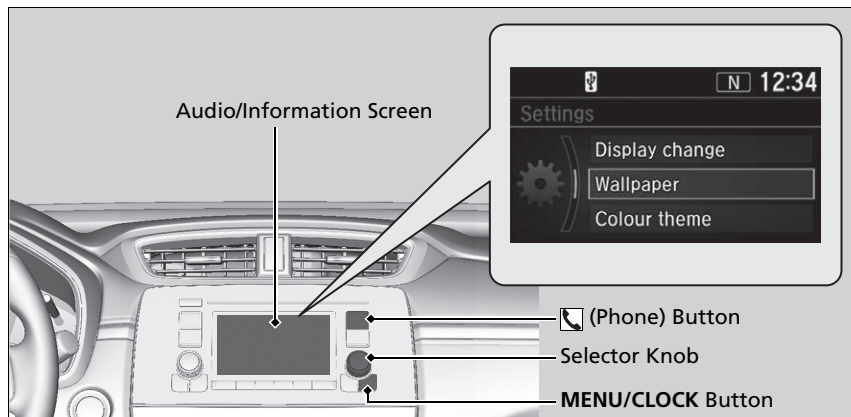

*1: Models with the keyless access system have an **ENGINE START/STOP** button instead of an ignition switch.

⌘ Customized Features

When you customize settings:



- Make sure that the vehicle is at a complete stop.
- Set the parking brake.

⌘ How to customize

These indications are used to show how to operate the selector knob.

Rotate  to select.

Press  to enter.

To customize other features, select **Settings**, rotate , then press .

➔ **List of customizable options** P. 409

Continued

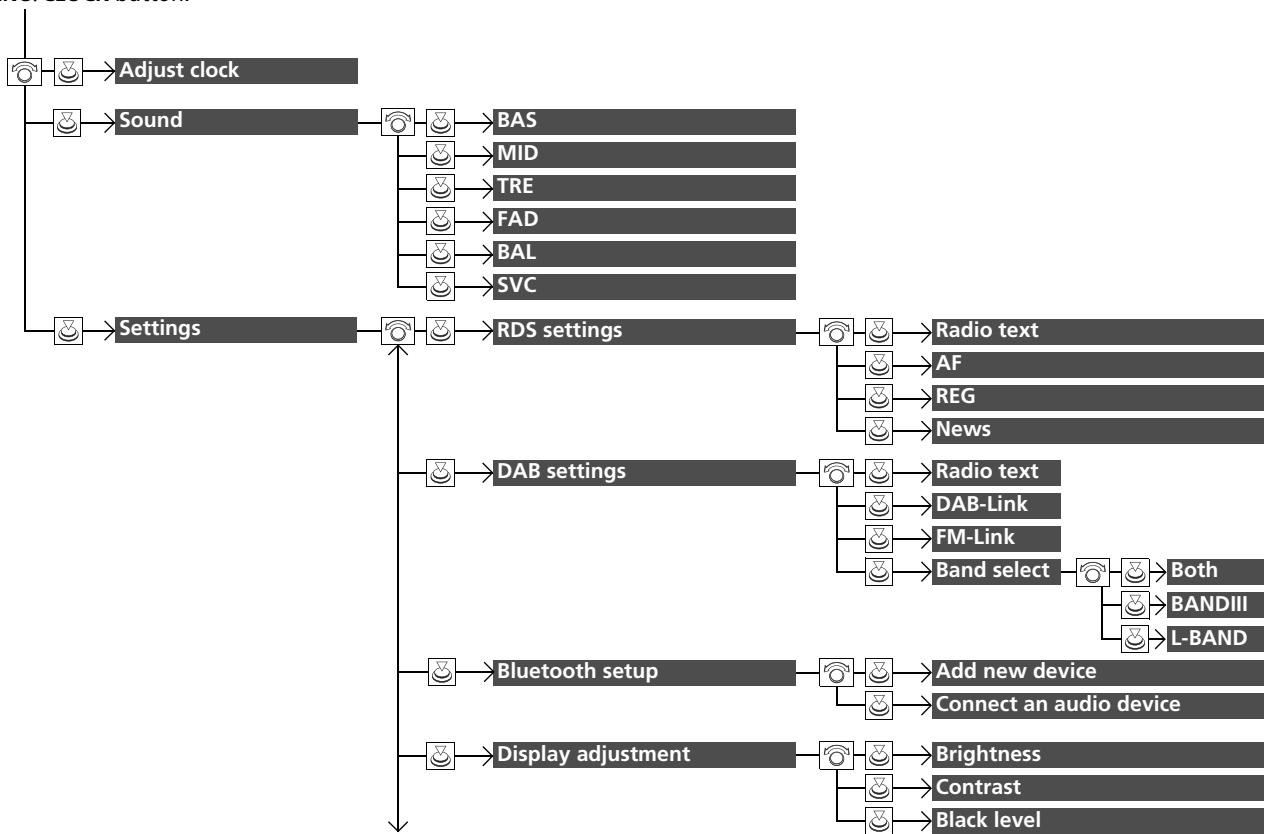

■ Customization Flow

Press the MENU/CLOCK button.

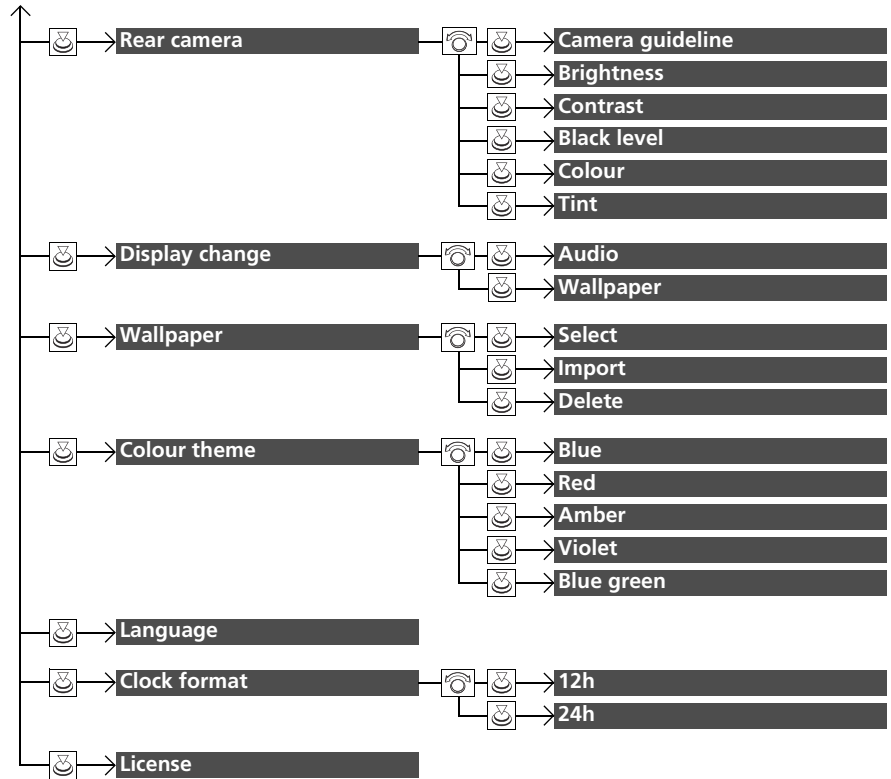



Features

Press the  button and rotate  to select **Phone setup**, then press .

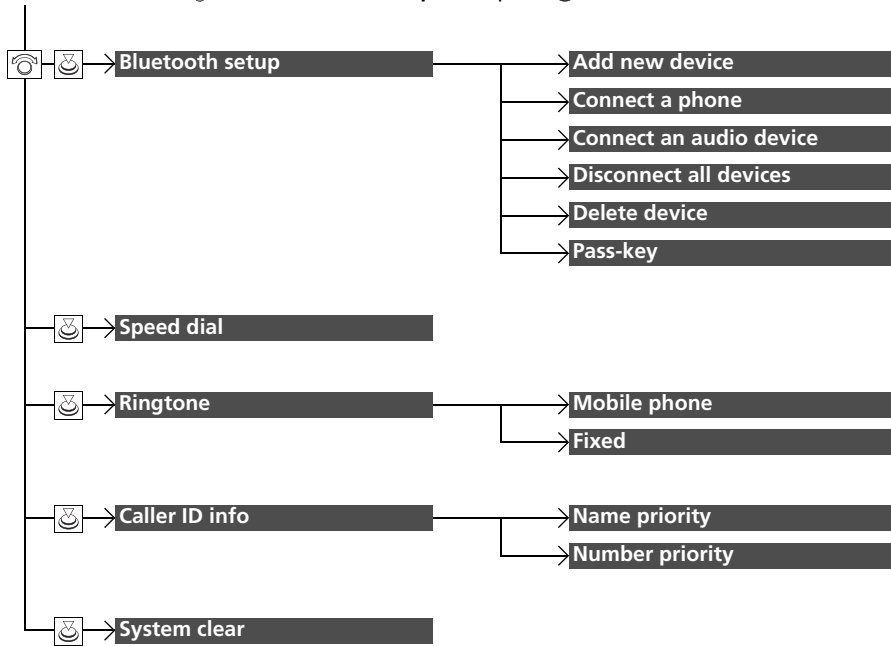

■ List of customizable options

Setup Group	Customizable Features	Description	Selectable Settings	
Adjust clock		Adjust Clock. ▶ Clock P. 176	—	
Sound		Adjusts the sound. ▶ Adjusting the Sound P. 311	BAS/MID/TRE/FAD/BAL/SVC	
Settings	RDS settings	Radio text	Displays the radio text information of the selected RDS station.	On/Off ^{*1}
		AF	Automatically changes the frequency of the same programme as you enter different region.	On ^{*1} / Off
		REG	Keeps the same frequency of the stations within that region even if the signal gets weak.	On ^{*1} / Off
		News	Turns on and off to automatically to tune to the news programme.	On/Off ^{*1}
	DAB settings	Radio text	Displays the radio text information of the selected DAB station.	On/Off ^{*1}
		DAB-Link	Selects whether the system automatically searches for the same station from Ensembles, and switches to it.	On ^{*1} / Off
		FM-Link	Selects whether the system finds the same station from an FM band, and automatically switches the band.	On ^{*1} / Off
		Band select	Selects specific bands to reduce the time to update the lists, and search for a station.	Both ^{*1} / BANDIII/L-BAND

*1:Default Setting

Setup Group	Customizable Features	Description	Selectable Settings	
Settings	Bluetooth setup	Add new device	Pairs a new phone to HFT, edits and deletes a paired phone, and create a code for a paired phone. ► Phone Setup P. 447	—
		Connect an audio device	Connects, disconnects or pairs a <i>Bluetooth®</i> Audio device to HFT.	—
	Display adjustment	Brightness	Changes the brightness of the audio/information screen.	—
		Contrast	Changes the contrast of the audio/information screen.	—
		Black level	Changes the black level of the audio/information screen.	—
	Rear camera	Camera guideline	Selects whether the guidelines come on the audio/information screen.	On^{*1}/Off
		Brightness	See Display adjustment on P. 410	
		Contrast		
		Black level		
		Colour	Changes the colour of the audio/information screen.	—
	Tint	Changes the tint of the audio/information screen.	—	
	Display change	Changes the display type.	Audio^{*1}/Wallpaper	

*1:Default Setting

Setup Group	Customizable Features	Description	Selectable Settings
Settings	Wallpaper	Select	Changes the wallpaper type. Clock^{*1}/Image 1/Image 2/ Image 3
		Import	Imports an image file for a new wallpaper.  Wallpaper Setup P. 309 —
		Delete	Deletes an image file for a wallpaper. Image 1/Image 2/Image 3
	Colour theme	Changes the background colour of the audio/ information screen. Blue^{*1}/Red/Amber/Violet/ Blue green	
	Language	Changes the display language. UK English^{*1}: See other selectable languages on the screen.	
	Clock format	Selects the digital clock display from 12H to 24H. 12h^{*1}/24h	
License	Shows the legal information. —		

*1:Default Setting

Setup Group	Customizable Features	Description	Selectable Settings
Phone setup	Add new device	Pairs a new phone to HFT. ➤ Phone Setup P. 447	—
	Connect a phone	Pairs a new phone or connects a paired phone to HFT. ➤ Phone Setup P. 447	—
	Connect an audio device	Connects a <i>Bluetooth</i> ® Audio device to HFT.	—
	Disconnect all devices	Disconnects a paired phone from HFT.	—
	Delete device	Deletes a paired phone.	—
	Pass-key	Inputs and changes a code for a paired phone.	—
	Speed dial	Edits, adds or deletes a speed dial entry. ➤ Speed Dial P. 455	—
	Ringtone	Selects the ring tone.	Mobile phone *1/ Fixed
	Caller ID info	Prioritizes the caller's name or phone number as the caller ID.	Name priority *1/ Number priority
	System clear	Cancels/Resets all customized items in the Phone setup group as default.	—

*1:Default Setting

Customized Features

Models with Display Audio

Use the audio/information screen to customize certain features.

■ How to customize

While the vehicle is at a complete stop with the ignition switch in ON **II***¹, select **HOME** and **Settings**, then select a setting item.

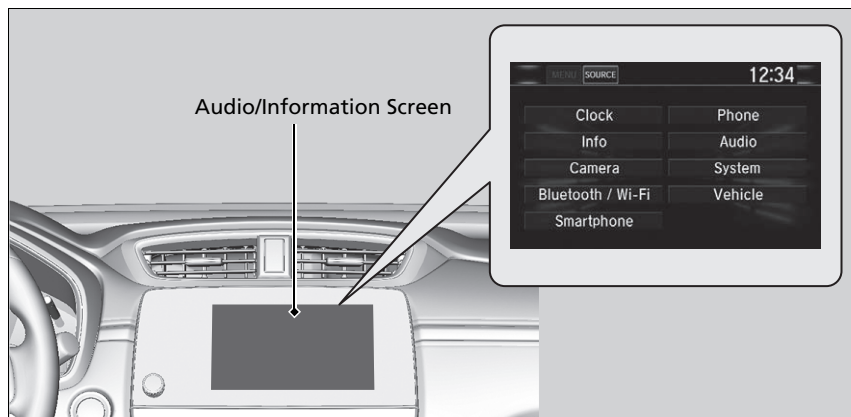

* 1: Models with the keyless access system have an **ENGINE START/STOP** button instead of an ignition switch.

Customized Features

When you customize settings:

- Make sure that the vehicle is at a complete stop.

Continuously variable transmission models

- Shift to **P**.

Manual transmission models

- Set the parking brake.

To customize other features, select **Settings**.

➔ **List of customizable options** P. 422

■ Customization flow

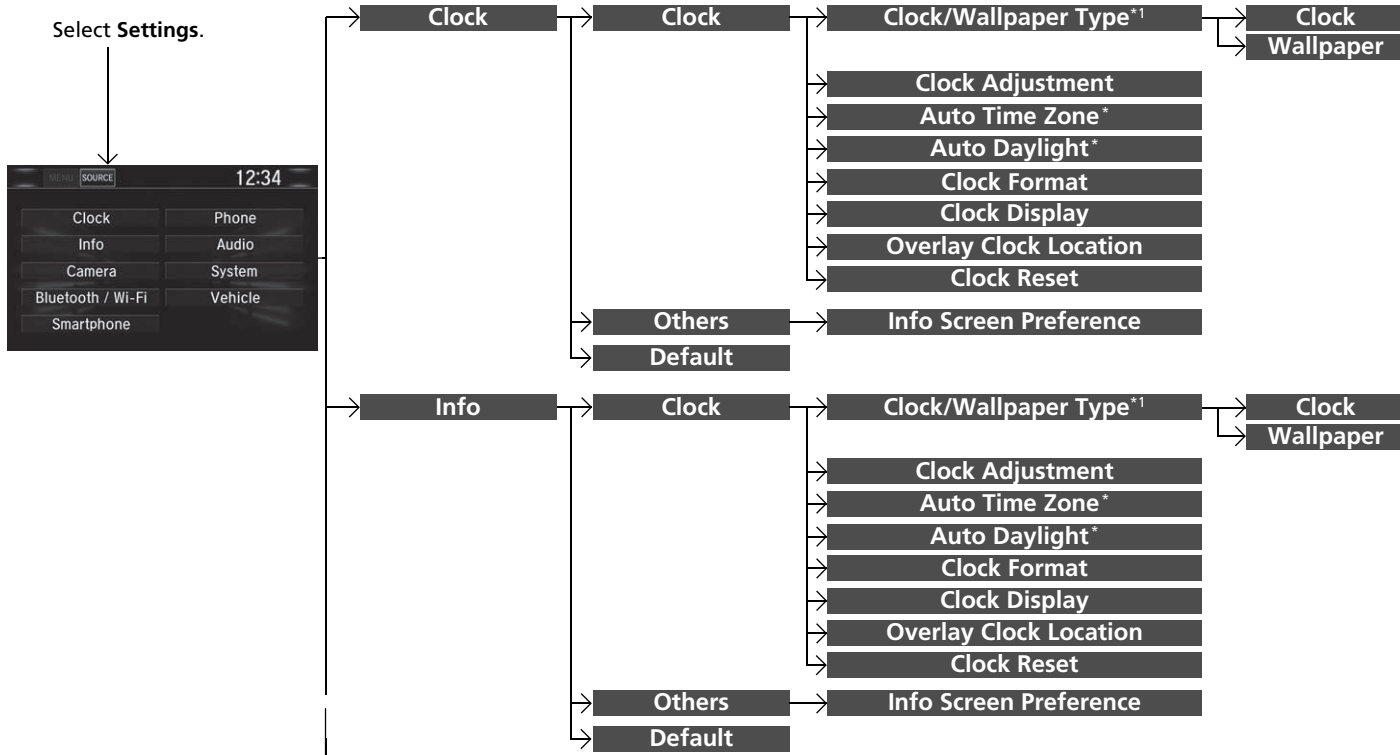

*1 : **Clock Type** appears when you change the screen interface design.

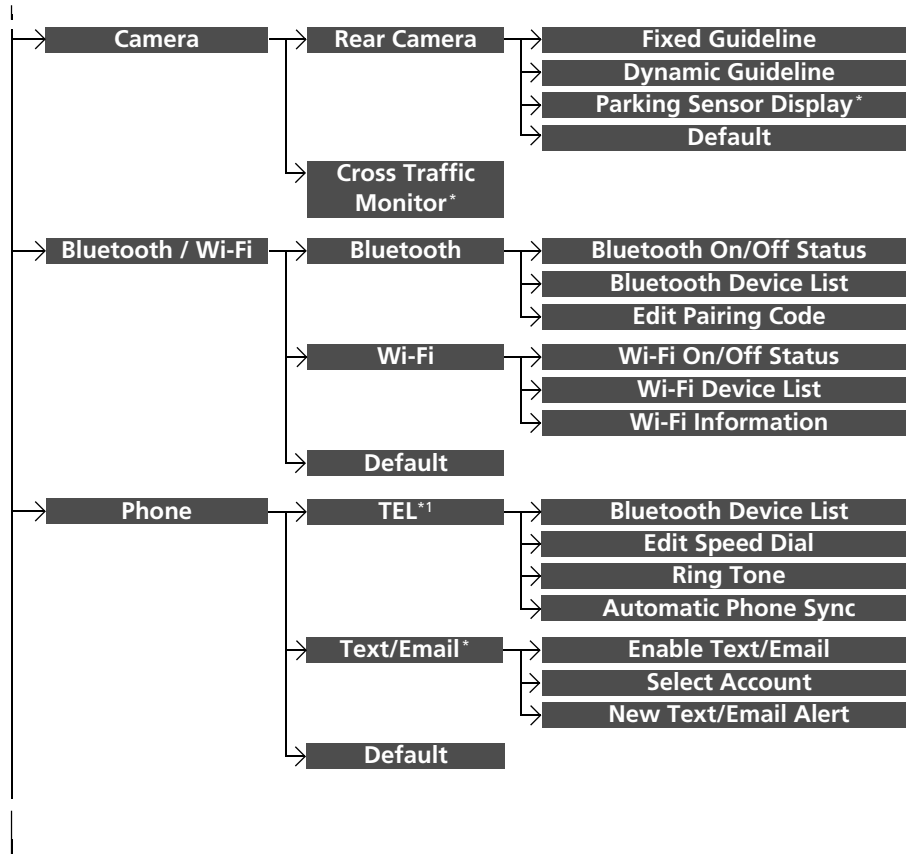

*1: **TEL** tab is displayed depending on models.

* Not available on all models

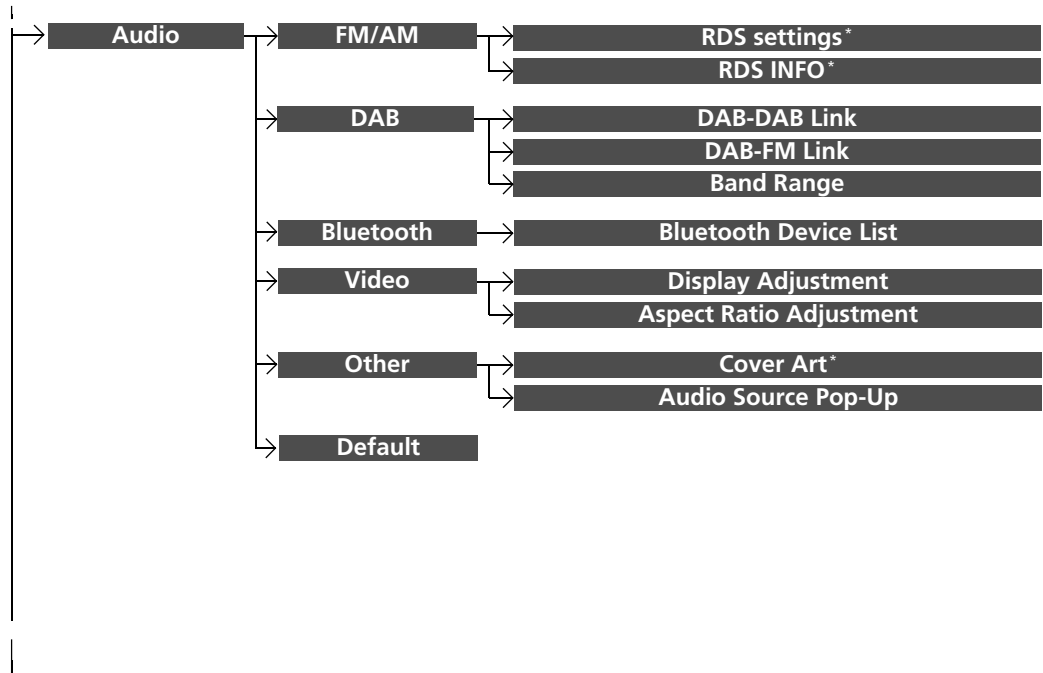

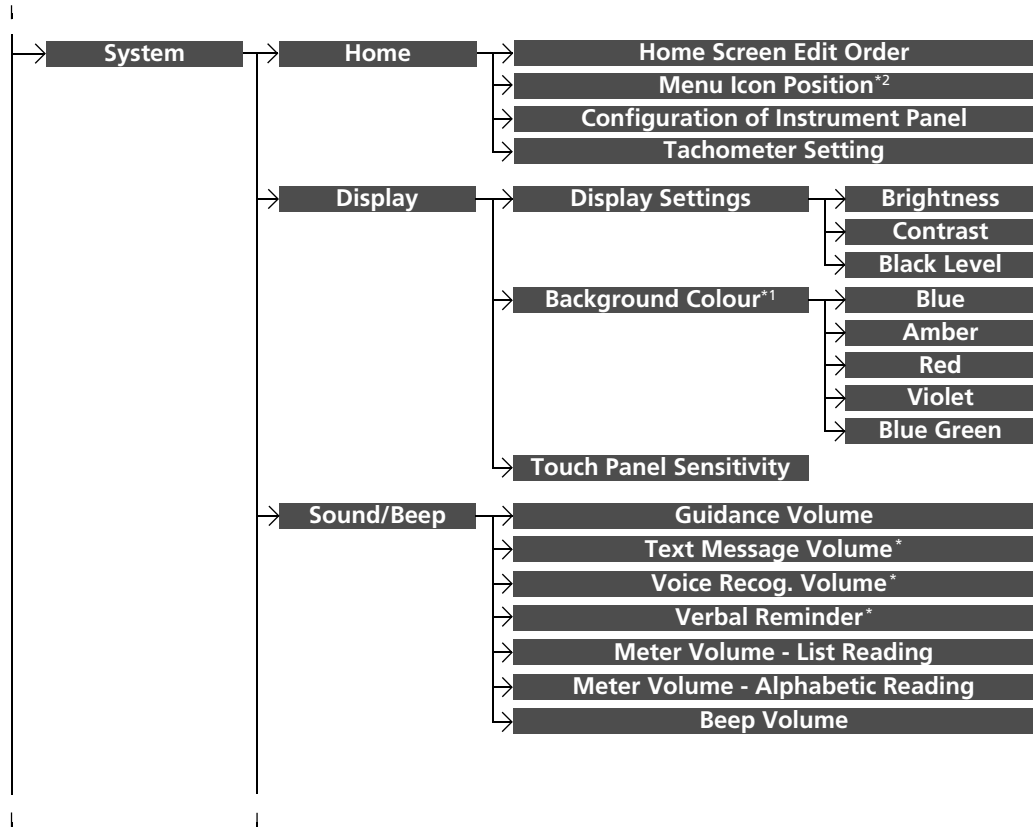

*1: Does not appear when you change the screen interface design.

*2: Appears only when you change the screen interface design.

* Not available on all models

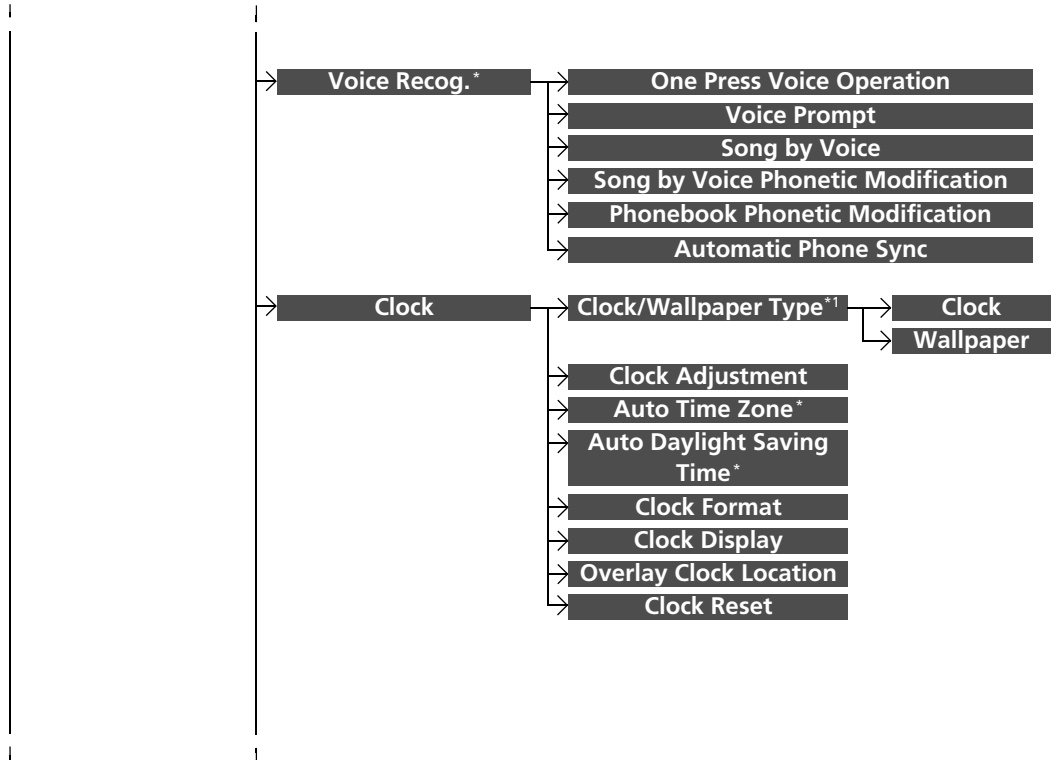

*1: **Clock Type** appears when you change the screen interface design.

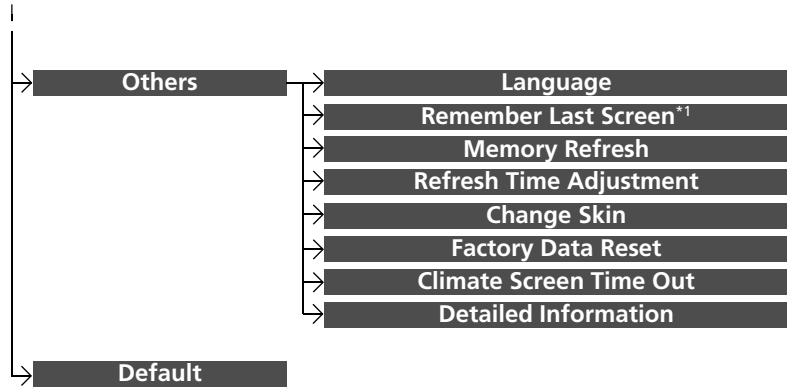

*1: Does not appear when you change the screen interface design.

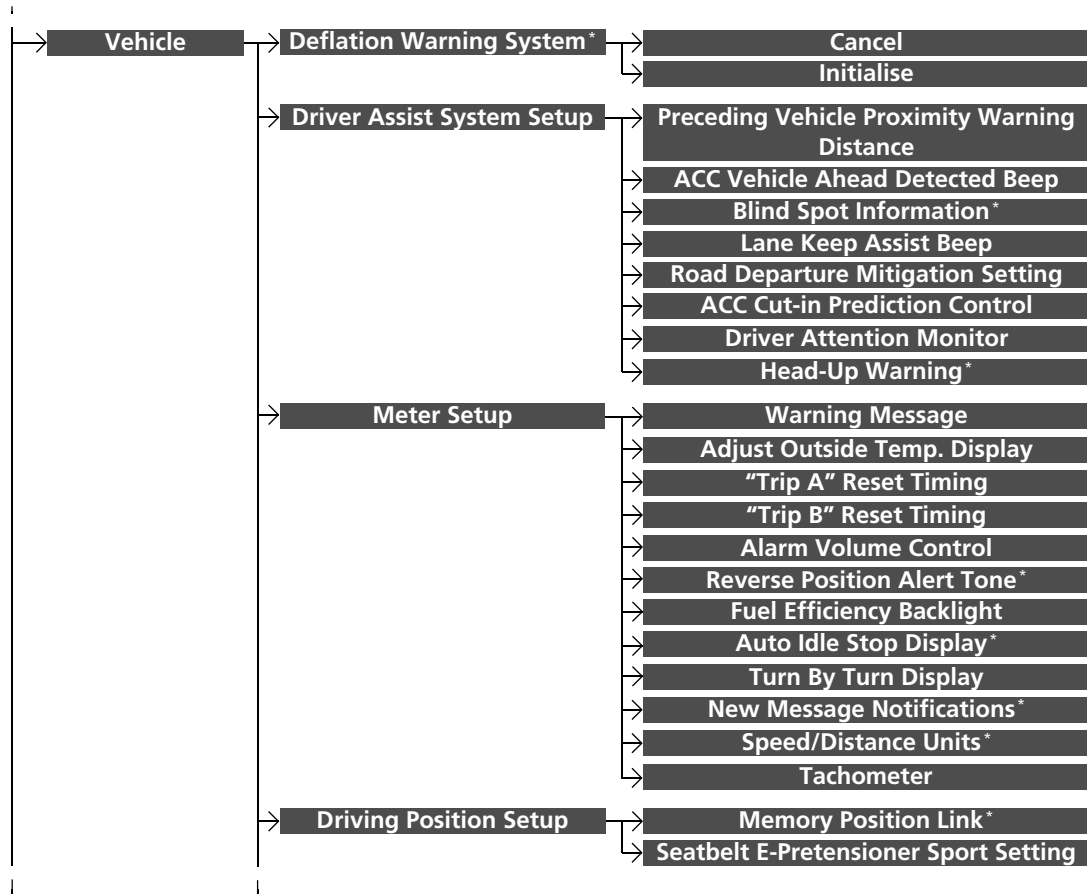

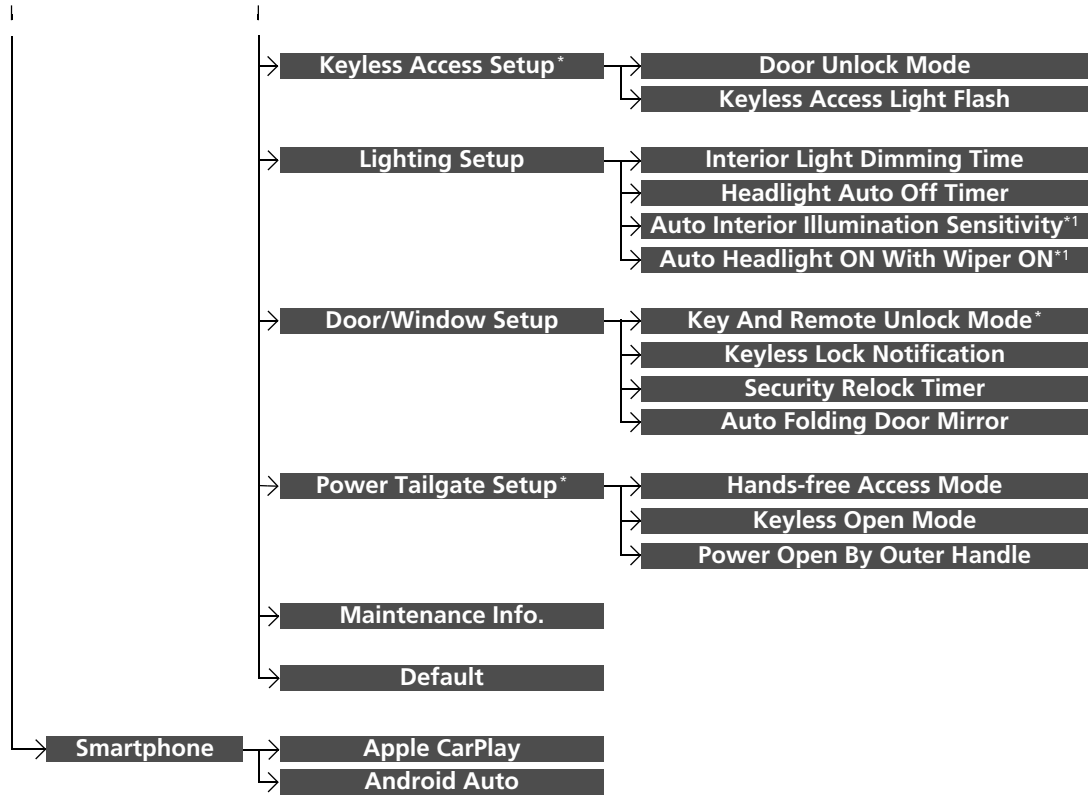

*1: Because this screen phrase varies depending on the models, it used in this manual may differ from the actual screen phrase.

* Not available on all models

■ List of customizable options

Setup Group	Customizable Features	Description	Selectable Settings	
Clock	Clock/Wallpaper Type* ¹ /Clock Type* ²	Clock Wallpaper	See Info on P. 423	
	Clock Adjustment			
	Auto Time Zone*			
	Auto Daylight*			
	Clock Format			
	Clock Display			
	Overlay Clock Location			
	Clock Reset			
	Others	Info Screen Preference		
	Default			Cancels/Resets all customized items in the Clock settings group as default.

*1: Does not appear when you change the screen interface design.

*2: Appears only when you change the screen interface design.

Setup Group	Customizable Features	Description	Selectable Settings	
Info	Clock	Clock	Changes the clock display type.	Analog/Digital*¹/ Small Digital/Off
		Wallpaper	<ul style="list-style-type: none"> • Changes the wallpaper type. • Imports an image file for a new wallpaper. • Deletes an image file for a wallpaper. 	Blank/Galaxy*¹/ Metallic
		Clock Adjustment	Adjusts Clock.	—
		Auto Time Zone*	Automatically adjusts the clock when driving through different time zones.	On*¹/Off
		Auto Daylight*	Select On to have the GPS automatically adjust the clock to daylight savings time. Select Off to cancel this function.	On*¹/Off
	Clock Format	Selects the digital clock display from 12H to 24H.	12H*¹/24H	

*1:Default Setting

*2:Does not appear when you change the screen interface design.

*3:Appears only when you change the screen interface design.

Setup Group	Customizable Features	Description	Selectable Settings	
Info	Clock Display	Selects whether the clock display comes on.	On^{*1}/Off	
	Clock	Overlay Clock Location	Changes the clock display layout.	Right Upper^{*1}/Left Upper/Right Lower/Left Lower/Off
		Clock Reset	Resets the clock settings to the factory default.	Yes/No
	Others	Info Screen Preference	Selects the top menu when the  (display/information) button is pressed. <ul style="list-style-type: none"> • Info Top- A brief menu pops up. • Info Menu- A full menu pops up. • Off- A menu does not pop up. 	Info Top/Info Menu^{*1}/Off
	Default		Cancels/Resets all customized items in the Info settings group as default.	Yes/No

*1:Default Setting

Setup Group	Customizable Features	Description	Selectable Settings
Camera	Rear Camera	Fixed Guideline Selects whether the fixed guidelines come on the rear camera monitor. ➤ Multi-View Rear Camera * P. 651	On^{*1}/Off
		Dynamic Guideline Selects whether the guidelines adjust to the movement of the steering wheel. ➤ Multi-View Rear Camera * P. 651	On^{*1}/Off
		Parking Sensor Display* Changes the view of the rear camera display.	Normal View/Split View^{*1}
		Default Cancels/Resets all customized items in the Rear Camera setting group as default.	Yes/No
	Cross Traffic Monitor*	Cross Traffic Monitor Turns the cross traffic monitor feature on and off.	On^{*1}/Off

*1:Default Setting

Setup Group	Customizable Features	Description	Selectable Settings
Bluetooth / Wi-Fi	Bluetooth On/Off Status	Changes the <i>Bluetooth</i> ® status.	On *1/ Off
	Bluetooth Device List	Pairs a new phone to HFT, edits or deletes a paired phone. ➤ Phone Setup P. 469	—
	Edit Pairing Code	Edits a pairing code. ➤ To change the pairing code setting P. 470	Random/Fixed *1
	Wi-Fi On/Off Status	Changes the Wi-Fi mode.	On/Off *1
	Wi-Fi Device List	Connects, disconnects, or deletes the Wi-Fi device.	—
	Wi-Fi Information	Shows the Wi-Fi information of the head unit.	—
Default		Cancels/Resets all customized items in the Bluetooth / Wi-Fi group as default.	Yes/No

*1:Default Setting

Setup Group	Customizable Features	Description	Selectable Settings
Phone	Bluetooth Device List	Pairs a new phone to HFT, connects or disconnects a paired phone. ▶ Phone Setup P. 469	—
	TEL *2 Edit Speed Dial	Edits, adds or deletes a speed dial entry. ▶ Speed Dial P. 475	—
	Ring Tone	Selects the ring tone.	Fixed/Mobile Phone *1
	Automatic Phone Sync	Sets a phonebook and call history data to be automatically imported when a phone is paired to HFT.	On *1/ Off
	Enable Text/Email	Turns the text/e-mail message function on and off.	On *1/ Off
	Text/Email * Select Account	Selects a text or e-mail message account.	—
	New Text/Email Alert	Selects whether a pop-up alert comes on the screen when HFT receives a new text/e-mail message.	On/Off
Default	Cancels/Resets all customized items in the Phone settings group as default.	Yes/No	

*1:Default Setting

*2:**TEL** tab is displayed depending on models.

* Not available on all models

Setup Group	Customizable Features	Description	Selectable Settings	
Audio	RDS settings*	TA Information	Turns on and off the traffic information.	On/Off^{*1}
		News	Turns on and off to automatically to tune to the news programme.	On/Off^{*1}
		REG	Turns on and off to keep the same stations within that region even if the signal gets weak.	On^{*1}/Off
		AF	Turns on and off to automatically change the frequency of the same programme as you enter different regions.	On^{*1}/Off
		RDS INFO*	Turns on and off the RDS information.	On^{*1}/Off
		DAB-DAB Link	Selects whether the system automatically searches for the same station from Ensembles, and switches to it.	On^{*1}/Off
	DAB mode DAB	DAB-FM Link	Selects whether the system finds the same station from an FM band, and automatically switches the band.	On^{*1}/Off
		Band Range	Selects specific bands to reduce the time to update the lists, and search for a station.	BOTH^{*1}/BAND III/L-BAND

*1:Default Setting

Setup Group	Customizable Features		Description	Selectable Settings	
	Bluetooth	Bluetooth Device List	Pairs a new phone to HFT, edits or deletes a paired phone. ▶ Phone Setup P. 469	—	
	Video	Display Adjustment	Brightness	See System on P. 430	
		Display	Contrast		
			Black Level		
		Display Adjustment	Colour	Changes the colour of the audio/information screen.	—
Audio	Video	Colour	Tint	Changes the tint of the audio/information screen.	—
		Aspect Ratio Adjustment	Selects the display mode with a different aspect ratio from Original (only USB), Normal , Full and Zoom .	Original * ¹ (only USB)/ Normal / Full * ¹ / Zoom	
		[Your selected media] Cover Art *	Turns the cover art display on and off.	On * ¹ / Off	
	Other	Audio Source Pop-Up	Selects whether the list of selectable audio source comes on when Audio is selected on the home screen.	On / Off * ¹	
	Default		Cancels/Resets all customized items in the Audio settings group as default.	Yes / No	

*1: Default Setting

* Not available on all models

Setup Group	Customizable Features	Description	Selectable Settings	
System	Home	Home Screen Edit Order	Changes the home screen icon layout. —	
		Menu Icon Position ^{*2}	Changes the position of the menu icons on the Audio , Phone , and Info screen. —	
		Configuration of Instrument Panel	Changes the Instrument Panel screen icon layout. —	
	Tachometer Setting	Turns on and off the tachometer display. On ^{*1} / Off		
	Display	Display Settings	Brightness	Changes the brightness of the audio/information screen. —
			Contrast	Changes the contrast of the audio/information screen. —
Black Level			Changes the black level of the audio/information screen. —	



*1: Default Setting

*2: Appears only when you change the screen interface design.

Setup Group	Customizable Features	Description	Selectable Settings	
System	Display	Background Colour ^{*2}	Changes the background colour of the audio/information screen.	Blue ^{*1} / Amber/Red/Violet/Blue Green
		Touch Panel Sensitivity	Sets the sensitivity of the touch panel screen.	High/Low ^{*1}
	Sound/ Beep	Guidance Volume	Changes the sound volume. Adjusts the guidance volume of the navigation system.	0~6 ^{*1} ~ 11
		Text Message Volume [*]	Changes the text/e-mail message reading volume.	1~6 ^{*1} ~ 11
		Voice Recog. Volume [*]	Changes the volume of the voice prompt.	1~6 ^{*1} ~ 11
		Meter Volume - List Reading	Changes the list reading volume.	0~6 ^{*1} ~ 11
		Meter Volume - Alphabetic Reading	Changes the alphabetic reading volume.	0~6 ^{*1} ~ 11
		Verbal Reminder [*]	Turns the verbal reminders on and off.	On ^{*1} / Off
		Beep Volume	Changes the beep volume.	Off/1/2 ^{*1} / 3

*1:Default Setting

*2:Does not appear when you change the screen interface design.

Setup Group	Customizable Features	Description	Selectable Settings	
System	Voice Recog.*	One Press Voice Operation	Changes the setting of the  (Talk) button operation when using the voice operation.	On ^{*1} /Off
		Voice Prompt	Turns the voice prompt on and off.	On ^{*1} /Off
		Song by Voice	Turns the Song By Voice™ on and off.	On ^{*1} /Off
		Song by Voice Phonetic Modification	Modifies a voice command for music stored in the system or an iPod/iPhone.  Phonetic Modification P. 372	—
		Phonebook Phonetic Modification	Modifies a voice command for the phonebook.  Phonebook Phonetic Modification * P. 478	—
		Automatic Phone Sync	Sets phonebook and call history data to be automatically imported when a phone is paired to HFT.	On/Off

*1:Default Setting

Setup Group	Customizable Features	Description	Selectable Settings
System	Clock	Clock/Wallpaper Type^{*1/} Clock Type^{*2}	Clock Wallpaper
		Clock Adjustment	
		Auto Time Zone[*]	
		Auto Daylight Saving Time[*]	See Info on P. 423
		Clock Format	
		Clock Display	
		Overlay Clock Location	
		Clock Reset	

*1: Does not appear when you change the screen interface design.

*2: Appears only when you change the screen interface design.

Setup Group	Customizable Features	Description	Selectable Settings
System	Language	Change the display language.	English (United Kingdom)*1 : See other selectable languages on the screen.
	Remember Last Screen*2	Selects whether the device remembers the last screen.	On/Off*1
	Memory Refresh	Turns on the audio system automatically and restores the fragmentation of a memory when the power mode is VEHICLE OFF (LOCK).	On*1/Off
	Refresh Time Adjustment	Sets the time for Memory Refresh .	—
	Change Skin	Changes the screen interface design.	Yes/No
	Factory Data Reset	Resets all the settings to their factory default. <input checked="" type="checkbox"/> Defaulting All the Settings P. 440	Yes/No
	Climate Screen Time Out	Changes the length of time the climate control display stays on when you press the CLIMATE button.	Never/5 Seconds/10 Seconds*1/20 Seconds
	Detailed Information	Displays the details of the head unit and operating system information.	—
Default	Cancels /Resets all customized items in the System group as default.	Yes/No	

*1:Default Setting

*2:Does not appear when you change the screen interface design.

Setup Group	Customizable Features	Description	Selectable Settings
Vehicle Driver Assist System Setup	Deflation Warning System*	Initialises the deflation warning system.	Cancel*¹/Initialise
	Preceding Vehicle Proximity Warning Distance	Changes the distance at which CMBS alerts.	Far/Normal*¹/Near
	ACC Vehicle Ahead Detected Beep	Causes the system to beep when the system detects a vehicle, or when the vehicle goes out of the ACC range.	On/Off*¹
	Blind Spot Information*	Changes the setting for the blind spot information.	Audible And Visual Alert*¹/Visual Alert Only/Off
	Lane Keep Assist Beep	Causes the system to beep when Lane Keeping Assist System (LKAS) is suspended.	On/Off*¹
	Road Departure Mitigation Setting	Changes the setting for the road departure mitigation system.	Early/Normal/Delayed*¹/Warning Only
	ACC Cut-in Prediction Control	Turns the ACC cut-in prediction control feature on and off.	On*¹/Off
	Driver Attention Monitor	Changes the setting for the driver attention monitor.	Tactile And Audible Alert*¹/Tactile Alert/Off
	Head-Up Warning*	Turns the head-up warning on and off.	On*¹/Off

*1:Default Setting

* Not available on all models

Setup Group	Customizable Features	Description	Selectable Settings	
Vehicle	Meter Setup			
		Warning Message	Selects whether the warning message comes on the driver information interface.	On/Off^{*1}
		Adjust Outside Temp. Display	Adjusts the temperature reading by a few degrees.	-3°C ~ ±0°C^{*1} ~ +3°C
		“Trip A” Reset Timing	Changes the setting of how to reset trip meter A and average fuel economy A.	When Refueled/When Ignition Is Turned Off/Manual Reset^{*1}
		“Trip B” Reset Timing	Changes the setting of how to reset trip meter B and average fuel economy B.	When Refueled/When Ignition Is Turned Off/Manual Reset^{*1}
		Alarm Volume Control	Changes the alarm volume, such as buzzers, warnings, turn signal sound, and so on.	Max/Mid^{*1}/Min
		Reverse Position Alert Tone[*]	Causes the beeper to sound when you move to [R] .	On^{*1}/Off
		Fuel Efficiency Backlight	Turns the ambient meter feature on and off.	On^{*1}/Off
	Auto Idle Stop Display[*]	Selects whether the Auto Idle Stop display comes on.	On^{*1}/Off	

*1:Default Setting

Setup Group	Customizable Features	Description	Selectable Settings	
Vehicle	Meter Setup	Turn By Turn Display	Selects whether the turn-by-turn display comes on during the route guidance in the meter and head-up display*.	On ^{*1} /Off
		New Message Notifications*	Used to select whether a pop-up alert comes on the screen when HFT receives a new text/e-mail message.	On ^{*1} /Off
		Speed/Distance Units*	Selects the trip computer units.	mph·miles ^{*1} / km/h·km
	Tachometer	Selects whether the tachometer come on the driver information interface.	On ^{*1} /Off	
	Driving Position Setup	Memory Position Link*	Turns the driving position memory system on and off.	On ^{*1} /Off
		Seatbelt E-Pretensioner Sport Setting	Turn on or off the seatbelt auto tension setting that removes seatbelt slack when the vehicle is started and during sporty manoeuvres.	On ^{*1} /Off
	Keyless Access Setup*	Door Unlock Mode	Changes which doors unlock when you grab the driver's door handle.	Driver Door Only ^{*1} / All Doors
		Keyless Access Light Flash	Causes some exterior lights to flash when you unlock/lock the doors.	On ^{*1} /Off

*1:Default Setting

* Not available on all models

Setup Group	Customizable Features	Description	Selectable Settings
Vehicle	Lighting Setup	Interior Light Dimming Time	Changes the length of time the interior lights stay on after you close the doors. 60sec/30sec*¹/15sec
		Headlight Auto Off Timer	Changes the length of time the exterior lights stay on after you close the driver's door. 60sec/30sec/15sec*¹/0sec
		Auto Interior Illumination Sensitivity*²	Changes the sensitivity of the brightness of the instrument panel when the headlight switch is in the AUTO position. Min/Low/Mid*¹/High/Max
		Auto Headlight ON With Wiper ON*²	Changes the settings for the wiper operation when the headlights automatically come on while the headlight switch is in the AUTO position. On*¹/Off
	Door/Window Setup	Key And Remote Unlock Mode*	Sets up the driver's door or all the doors to unlock on the first push of the remote. Driver Door Only*¹/All Doors
		Keyless Lock Notification	LOCK/UNLOCK- The exterior lights flash. LOCK (2nd push)- The beeper sounds. On*¹/Off
		Security Relock Timer	Changes the time it takes for the doors to relock and the security system to set after you unlock the vehicle without opening any door. 90sec/60sec/30sec*¹
	Auto Folding Door Mirror	Changes how you can fold the door mirrors. Auto Fold With Keyless*¹/Manual Only	

*1: Default Setting

*2: Because this screen phrase varies depending on the models, it used in this manual may differ from the actual screen phrase.

Setup Group	Customizable Features	Description	Selectable Settings	
Vehicle	Hands-free Access Mode	Changes the setting to open power tailgate by a swift forward in and out kicking motion under the rear bumper.	On^{*1}/Off	
	Power Tailgate Setup[*]	Keyless Open Mode	Changes the keyless setting for when the power tailgate opens.	Anytime^{*1}/When Unlocked
	Power Open By Outer Handle	Changes the setting to open power tailgate by tailgate outer handle.	Off (Manual only)/On (Power/Manual)^{*1}	
	Maintenance Info.	Used to reset the service reminder system information display*/oil monitor system information* when the maintenance service has been performed.	—	
	Default	Cancels/Resets all customized items in the Vehicle settings group as default.	Yes/No	
Smartphone	Apple CarPlay	Sets up the Apple CarPlay connection.	—	
	Android Auto	Sets up the Android Auto connection.	—	

*1:Default Setting

* Not available on all models

Defaulting All the Settings

Reset all the menu and customized settings as the factory defaults.

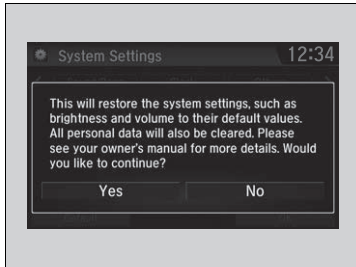

1. Select .
2. Select **Settings**.
3. Select **System**.
4. Select the **Others** tab.
5. Select **Factory Data Reset**.
 - A confirmation message appears on the screen.
6. Select **Yes** to reset the settings.
7. Select **Yes** again to reset the settings.
 - A confirmation message appears on the screen. Select **OK**.
 - After selecting **OK**, the system will reboot.

►► Defaulting All the Settings

When you transfer the vehicle to a third party, reset all settings to default and delete all personal data.

If you perform **Factory Data Reset**, it will reset the preinstalled apps to their factory default.

Hands-Free Telephone System

Models with colour audio system

The Hands-Free Telephone (HFT) System allows you to place and receive phone calls using your vehicle's audio system, without handling your mobile phone.

Using HFT

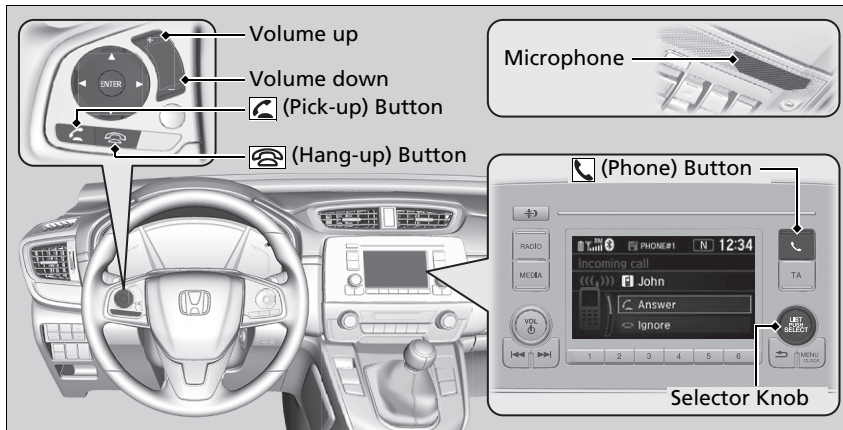

HFT Buttons



(Pick-up) button: Press to go directly to the phone screen or to answer an incoming call.

(Hang-up) button: Press to end a call.

(Phone) button: Press to go directly to the phone screen.

Selector knob: Rotate  to select an item on the screen, then press .

Hands-Free Telephone System

Place your phone where you can get good reception.

To use HFT, you need a *Bluetooth*-compatible mobile phone. For a list of compatible phones, pairing procedures, and special feature capabilities, ask a dealer.

If you receive a call while using the audio system, the system resumes its operation after ending the call.

Up to 20 speed dial entries can be stored. If there is no entry in the system, Speed Dial is disabled.

Speed Dial P. 455

Up to 20 call histories can be stored. If there is no call history, Call History is disabled.

Bluetooth® Wireless Technology

The *Bluetooth*® word mark and logos are registered trademarks owned by *Bluetooth* SIG, Inc., and any use of such marks by Honda Motor Co., Ltd., is under license. Other trademarks and trade names are those of their respective owners.

HFT Limitations

An incoming call on HFT will interrupt the audio system when it is playing. It will resume when the call is ended.

HFT Status Display

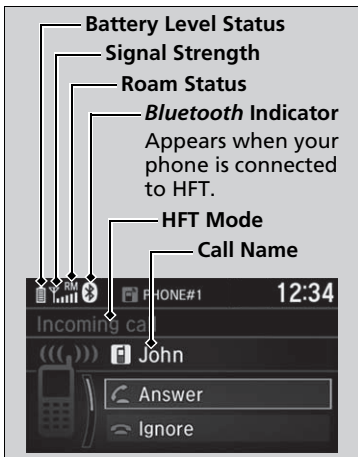

The audio/information screen notifies you when there is an incoming call.

Limitations for Manual Operation

Certain manual functions are disabled or inoperable while the vehicle is in motion. You cannot select a greyed-out option until the vehicle is stopped.

HFT Status Display

The information that appears on the audio/information screen varies between phone models.

You can change the system language.

➤ **Customized Features** P. 405

HFT Menus

The ignition switch must be in ACCESSORY **I** or ON **II** to use HFT.

HFT Menu

To use HFT, you must first pair your *Bluetooth*-compatible mobile phone to the system while the vehicle is parked.

Some functions are limited while driving. A message appears on the screen when the vehicle is moving and the operation is cancelled.

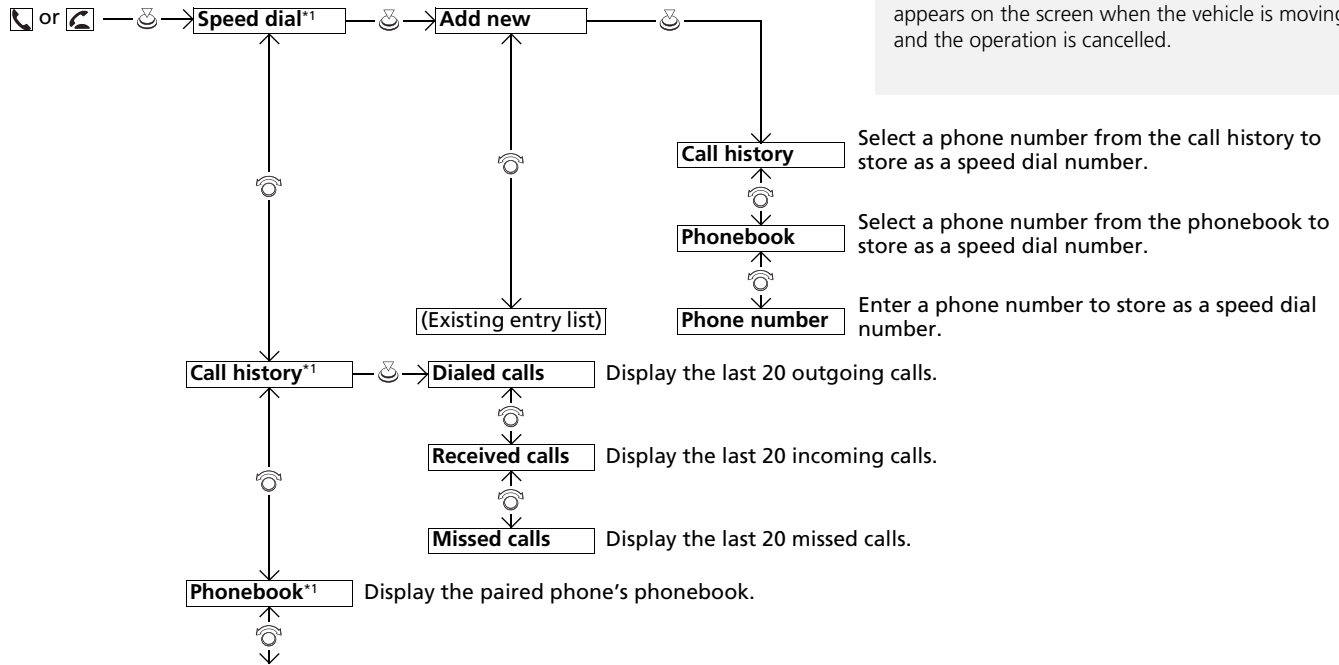

*1: Appears only when a phone is connected to HFT.

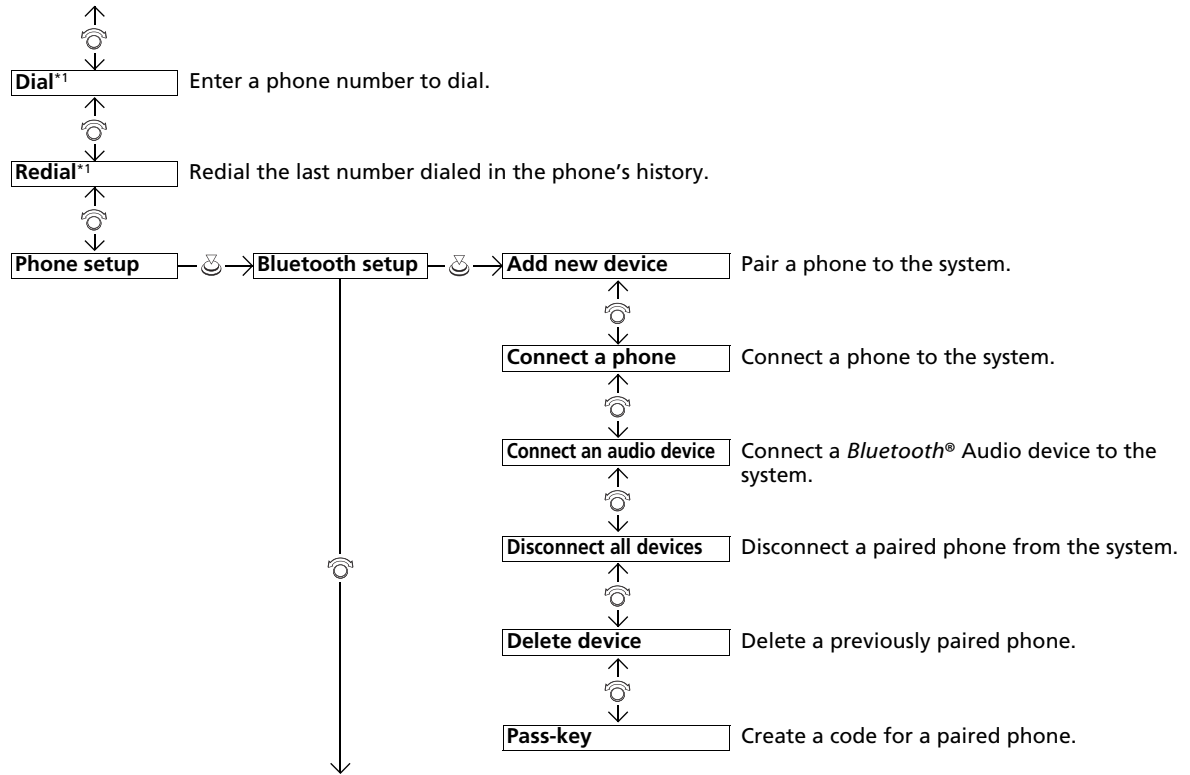

*1 : Appears only when a phone is connected to HFT.

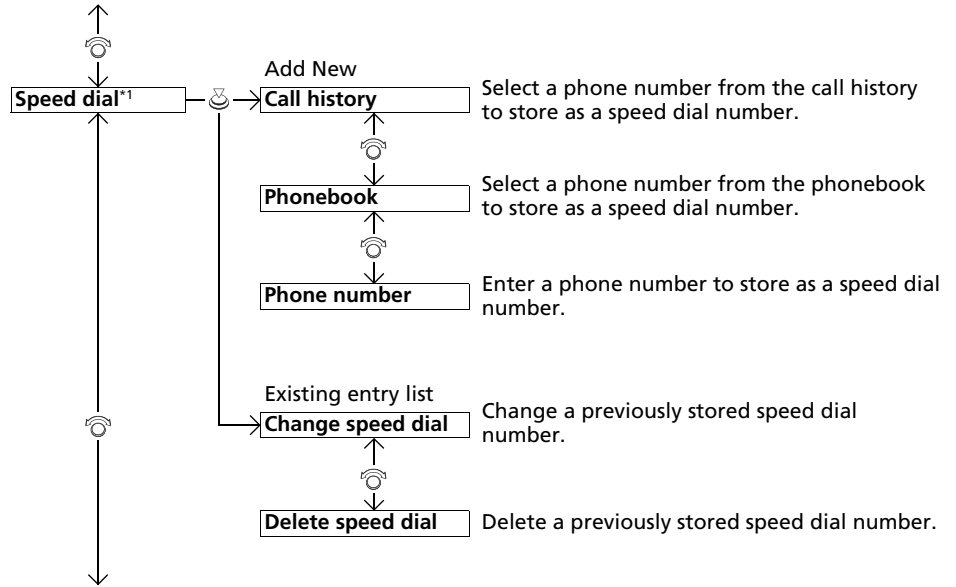

*1: Appears only when a phone is connected to HFT.

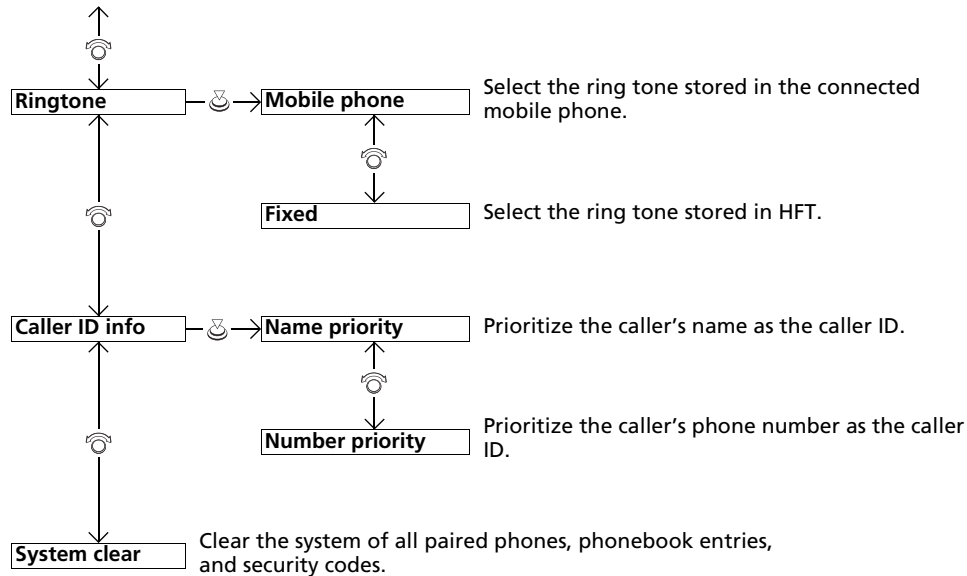

Phone Setup

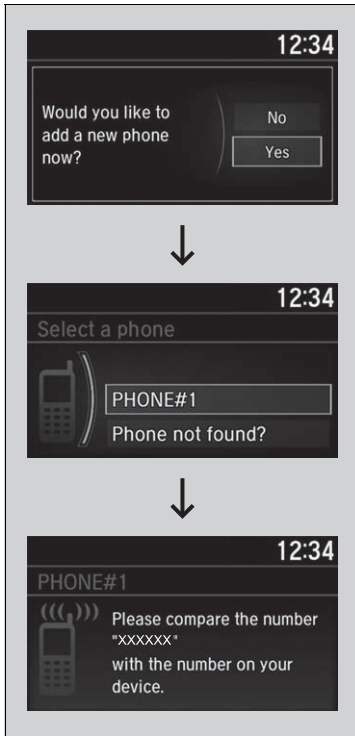

■ To pair a mobile phone (No phone has been paired to the system)

1. Press the button or the button.
2. Rotate to select **Yes**, then press .
3. Press to select **OK**.
4. Make sure your phone is in search or discoverable mode.
 - ▶ HFT automatically searches for a *Bluetooth*® device.
5. When your phone appears on the list, select it by pressing .
 - ▶ If your phone doesn't appear, select **Phone not found?** and search for *Bluetooth*® devices using your phone. From your phone, select **Honda HFT**.
6. The system gives you a pairing code on the audio/information screen.
 - ▶ Confirm if the pairing code on the screen and your phone match. This may vary by phone.
7. A notification appears on the screen if pairing is successful.

☒ Phone Setup

Your *Bluetooth*-compatible phone must be paired to HFT before you can make and receive hands-free calls.

Phone Pairing Tips:

- You cannot pair your phone while the vehicle is moving.
- Up to six phones can be paired.
- Your phone's battery may drain faster when it is paired to HFT.
- If your phone is not ready for pairing or not found by the system within 30 seconds, the system will time out and return to idle.

Once you have paired a phone, you can see it displayed on the screen with one or two icons on the right side.

These icons indicate the following:

: The phone can be used with HFT.

: The phone is compatible with *Bluetooth*® Audio.

■ To pair a mobile phone (when a phone has already been paired to the system)

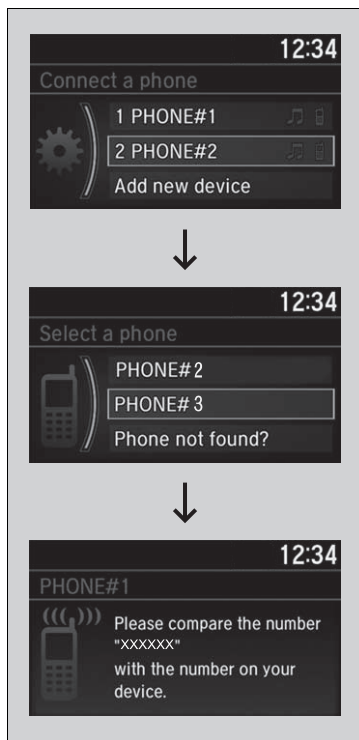

1. Press the button or the button.
2. Rotate to select **Yes**, then press .
3. Rotate to select **Add new device**, then press .
4. Press to select **OK**.
 - ▶ The screen changes to device list.
5. Make sure your phone is in search or discoverable mode, then press .
 - ▶ HFT automatically searches for a *Bluetooth*[®] device.
6. When your phone appears on the list, select it by pressing .
 - ▶ If your phone does not appear, select **Phone not found?** and search for *Bluetooth*[®] devices using your phone. From your phone, select **Honda HFT**.
7. The system gives you a pairing code on the audio/information screen.
 - ▶ Confirm if the pairing code on the screen and your phone match. This may vary by a phone.

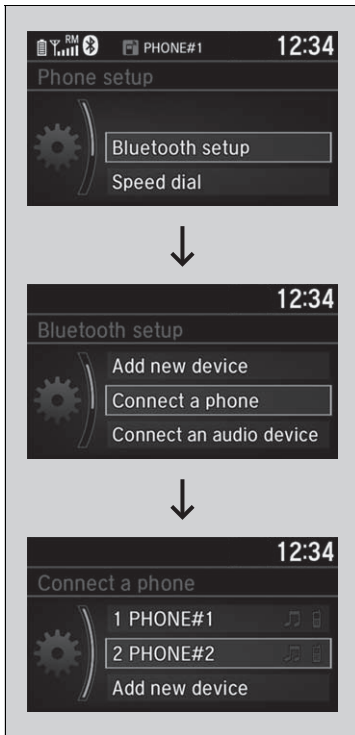

■ To change the currently paired phone

1. Press the button or the button.
2. Rotate to select **Phone setup**, then press .
3. Rotate to select **Bluetooth setup**, then press .
4. Rotate to select **Connect a phone**, then press .
 - ▶ The screen changes to a device list.
5. Rotate to select a desired device name, then press .
 - ▶ HFT disconnects the connected phone and starts searching for another paired phone.



■ **To change the pairing code setting**

1. Press the button or the button.
2. Rotate to select **Phone setup**, then press .
3. Rotate to select **Bluetooth setup**, then press .
4. Rotate to select **Pass-key**, then press .
5. Input a new pairing code, then press .



■ To delete a paired phone

1. Press the button or the button.
2. Rotate to select **Phone setup**, then press .
3. Rotate to select **Bluetooth setup**, then press .
4. Rotate to select **Delete device**, then press .
 - ▶ The screen changes to a device list.
5. Rotate to select a phone you want to delete, then press .
6. A confirmation message appears on the screen. Rotate to select **Yes**, then press .

■ Ring Tone

You can change the ring tone setting.

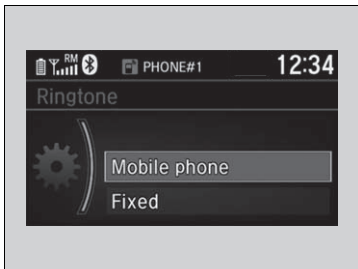

1. Press the button or the button.
2. Rotate to select **Phone setup**, then press .
3. Rotate to select **Ringtone**, then press .
4. Rotate to select **Mobile phone** or **Fixed**, then press .

■ Caller's ID Information

You can select a caller's information to be displayed when you have an incoming call.

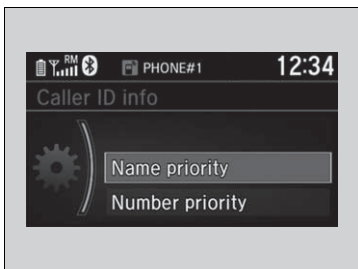

1. Press the button or the button.
2. Rotate to select **Phone setup**, then press .
3. Rotate to select **Caller ID info**, then press .
4. Rotate to select a mode you want, then press .

▶▶ Ring Tone

Mobile phone: For certain connected phones, the ring tone stored in the phone sounds from the speakers.

Fixed: The fixed ring tone sounds from the speakers.

▶▶ Caller's ID Information

Name priority: A caller's name is displayed if it is stored in the phonebook.

Number priority: A caller's phone number is displayed.

To Clear the System

Pairing codes, paired phones, all speed dial entries, all call history data, and all imported phonebook data are erased.

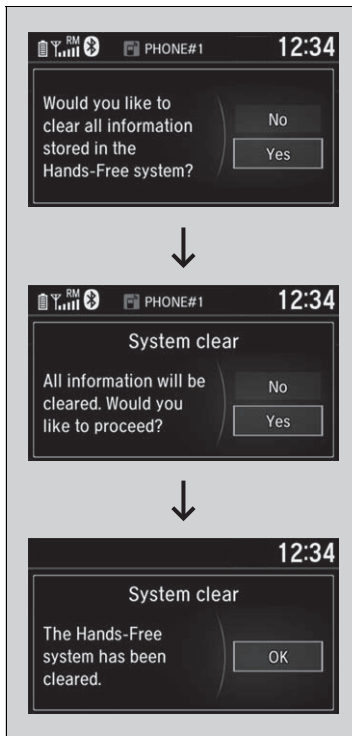

1. Press the button or the button.
2. Rotate to select **Phone setup**, then press .
3. Rotate to select **System clear**, then press .
4. Rotate to select **Yes**, then press .
5. A confirmation message appears on the screen. Rotate to select **Yes**, then press .
6. A notification appears on the screen. Press .

■ Automatic Import of Cellular Phonebook and Call History

When your phone is paired, the contents of its phonebook and call history are automatically imported to HFT.

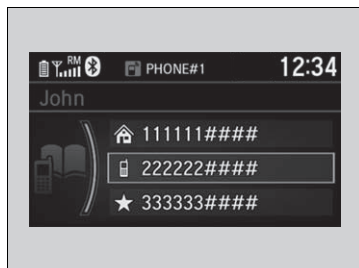

▶▶ Automatic Import of Cellular Phonebook and Call History

When you select a person from the list in the cellular phonebook, you can see up to three category icons. The icons indicate what types of numbers are stored for that name.

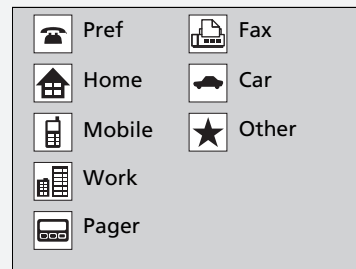

If a name has four or more numbers, ... appears instead of category icons.

On some phones, it may not be possible to import the category icons to HFT.

The phonebook is updated after every connection. Call history is updated after every connection or call.

Speed Dial

Up to 20 speed dial numbers can be stored per phone.

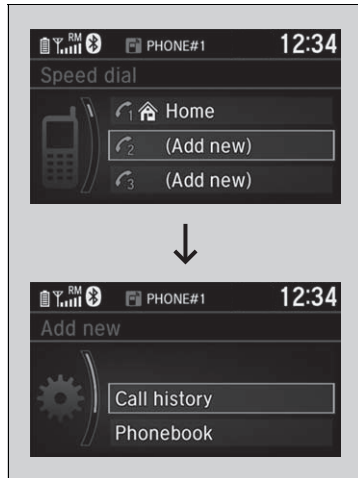

To store a speed dial number:

1. Press the button or the button.
2. Rotate to select **Speed dial**, then press .
3. Rotate to select **Add new**, then press .
4. Rotate to select a place to choose a number from, then press .
 - From **Call history**:
 - ▶ Select a number from the call history.
 - From **Phonebook**:
 - ▶ Select a number from the connected mobile phone's imported phonebook.
 - From **Phone number**:
 - ▶ Input the number manually.

Speed Dial

When any preset button is pressed, the **Speed dial** screen is displayed.

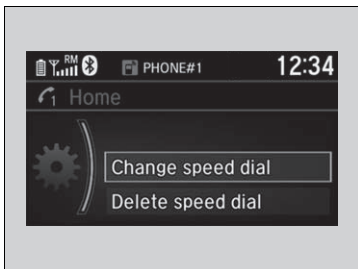

■ **To edit a speed dial**

1. Press the button or the button.
2. Rotate to select **Phone setup**, then press .
3. Rotate to select **Speed dial**, then press .
4. Select an existing speed dial entry.
5. Rotate to select **Change speed dial**, then press .
6. Select a new speed dial number, then press .

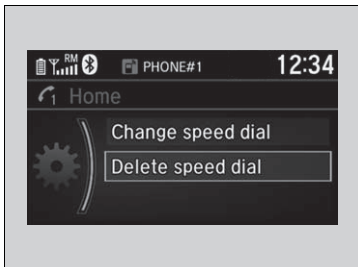

■ **To delete a speed dial number**

1. Press the button or the button.
2. Rotate to select **Phone setup**, then press .
3. Rotate to select **Speed dial**, then press .
4. Select an existing speed dial entry.
5. Rotate to select **Delete speed dial**, then press .
 - ▶ A confirmation message appears on the screen. Rotate to select **Yes**, then press .

■ Making a Call

You can make calls by inputting any phone number, or by using the imported phonebook, call history, speed dial entries, or redial.



▶▶ Making a Call

Once a call is connected, you can hear the voice of the person you are calling through the audio speakers.

Continued



■ **To make a call using the imported phonebook**

When your phone is paired, the contents of its phonebook are automatically imported to HFT.

1. Press the button or the button.
 2. Rotate to select **Phonebook**, then press .
 3. The phonebook is stored alphabetically. Rotate to select the initial, then press .
 4. Rotate to select a name, then press .
 5. Rotate to select a number, then press .
- ▶ Dialing starts automatically.



■ **To make a call using a phone number**

1. Press the button or the button.
 2. Rotate to select **Dial**, then press .
 3. Rotate to select a number, then press .
 4. Rotate to select , then press .
- ▶ Dialing starts automatically.



■ To make a call using redial

1. Press the button or the button.
2. Rotate to select **Redial**, then press .
 - ▶ Dialing starts automatically.



■ To make a call using the call history

Call history is stored by **Dialed calls**, **Received calls**, and **Missed calls**.

1. Press the button or the button.
2. Rotate to select **Call history**, then press .
3. Rotate to select **Dialed calls**, **Received calls**, or **Missed calls**, then press .
4. Rotate to select a number, then press .
 - ▶ Dialing starts automatically.

☒ To make a call using redial

Press and hold the button to redial the last number dialed in your phone's call history.

☒ To make a call using the call history

The call history appears only when a phone is connected to HFT, and displays the last 20 dialed, received, or missed calls.



■ **To make a call using a speed dial entry**

1. Press the button or the button.
2. Rotate to select **Speed dial**, then press .
3. Rotate to select a number, then press .
 - ▶ Dialing starts automatically.

■ **Receiving a Call**

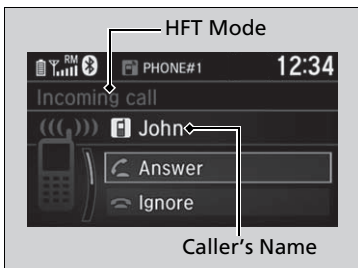

When there is an incoming call, an audible notification sounds and the **Incoming call** screen appears.

- Press the button to answer the call.
 Press the button to decline or end the call.

▶▶ **To make a call using a speed dial entry**

When any preset button is pressed, the **Speed dial** screen is displayed.

Select **Others** to view another paired phone's speed dial list.

▶▶ **Receiving a Call**

- Call Waiting**
 Press the button to put the current call on hold to answer the incoming call.
 Press the button again to return to the current call.
 Select **Ignore** to ignore the incoming call if you do not want to answer it.
 Press the button if you want to hang up the current call.

You can select the icons on the audio/information screen instead of the and buttons. Rotate to select the icon, then press .

Options During a Call

The following options are available during a call.



Swap call: Put the current call on hold to answer the incoming call.

Mute: Mute your voice.

Transfer call: Transfer a call from HFT to your phone.

Dial tones: Send numbers during a call. This is useful when you call a menu-driven phone system.



1. To view the available options, press the  button.
2. Rotate  to select the option, then press .
 - ▶ The check box is checked when **Mute** is selected. Select **Mute** again to turn it off.

Options During a Call

Dial tones: Available on some phones.

Models with Display Audio

The Hands-Free Telephone (HFT) System allows you to place and receive phone calls using your vehicle's audio system, without handling your mobile phone.

Using HFT

HFT Buttons

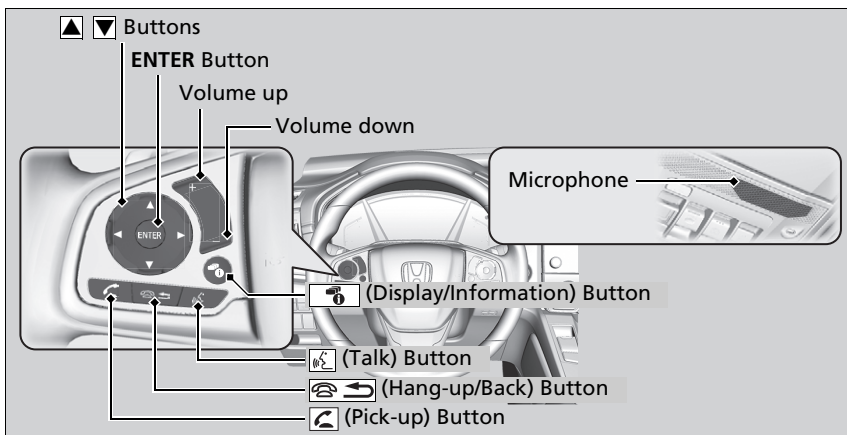

Hands-Free Telephone System

Place your phone where you can get good reception.

To use HFT, you need a *Bluetooth*-compatible mobile phone. For a list of compatible phones, pairing procedures, and special feature capabilities, ask a dealer.

To use the system, the **Bluetooth On/Off Status** setting must be **On**. If there is an active connection to Apple CarPlay or Android Auto, HFT is unavailable.

➤ **How to customize** P. 413

Voice control tips

- Aim the vents away from the ceiling and close the windows, as noise coming from them may interfere with the microphone.
- Press the  button when you want to call a number using a stored voice tag. Speak clearly and naturally after a beep.
- If the microphone picks up voices other than yours, the command may be misinterpreted.
- To change the volume level, select the audio system's **VOL** (Volume) or use the remote audio controls on the steering wheel.

Up to three speed dial entries can be displayed among a total of 20 that can be entered.

➤ **Speed Dial** P. 475

Up to three previous calls can be displayed at a time among a total of 20 that can be entered. If there is no call history, Call History is disabled.

 **(Pick-up) button:** Press to go directly to the phone menu on the driver information interface, or to answer an incoming call.

 **(Hang-up/back) button:** Press to end a call, go back to the previous command, or cancel a command.

 **(Talk) button:** Press to access Voice Portal.

 **buttons:** Press to select an item displayed on the phone menu in the driver information interface.

ENTER button: Press to call a number listed in the selected item on the phone menu in the driver information interface.

 **(Display/information) button:** Select and press **ENTER** to display **Speed Dial**, **Call History**, or **Phonebook** on the phone menu in the driver information interface.

To go to the **Phone Menu** screen:

1. Select  to switch the display to the phone screen.
2. Select **MENU**.

Hands-Free Telephone System

Bluetooth[®] Wireless Technology

The *Bluetooth*[®] word mark and logos are registered trademarks owned by *Bluetooth SIG, Inc.*, and any use of such marks by Honda Motor Co., Ltd., is under license. Other trademarks and trade names are those of their respective owners.

HFT Limitations

An incoming call on HFT will interrupt the audio system when it is playing. It will resume when the call is ended.

■ HFT Status Display

The audio/information screen notifies you when there is an incoming call.

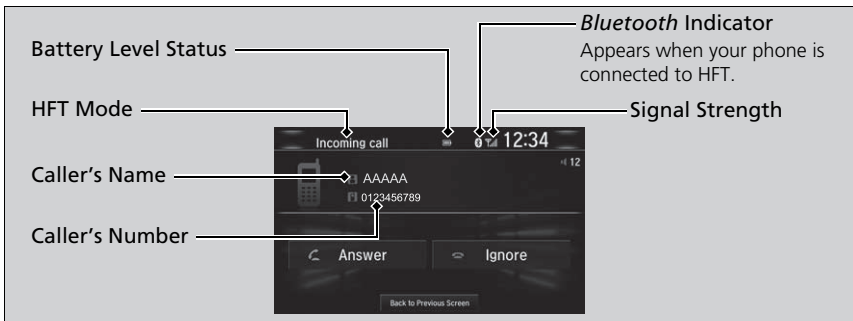

■ Limitations for Manual Operation

Certain manual functions are disabled or inoperable while the vehicle is in motion. You cannot select a greyed-out option until the vehicle is stopped.

Only previously stored speed dial entries with voice tags, phonebook names, or numbers can be called using voice commands while the vehicle is in motion.

▶ **Speed Dial** P. 475

▶ HFT Status Display

The information that appears on the audio/information screen varies between phone models.

You can change the system language.

▶ **How to customize** P. 413

HFT Menus

The ignition switch must be in ACCESSORY or ON *1 to use the system.

■ Phone Settings screen

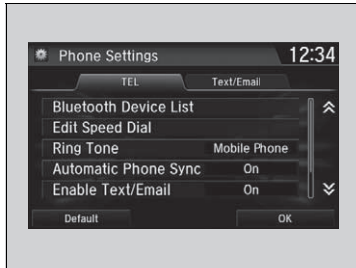

1. Select .
2. Select **Settings**.
3. Select **Phone**.

▶▶ HFT Menu

To use HFT, you must first pair your *Bluetooth*-compatible mobile phone to the system while the vehicle is parked.

Some functions are limited while driving.

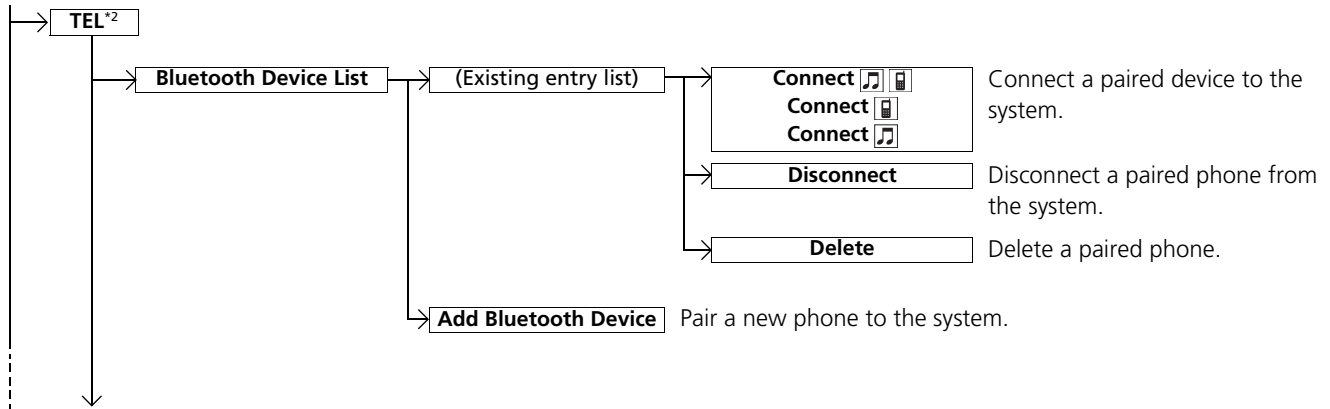

*1: Models with the keyless access system have an **ENGINE START/STOP** button instead of an ignition switch.

*2: **TEL** tab is displayed depending on models.

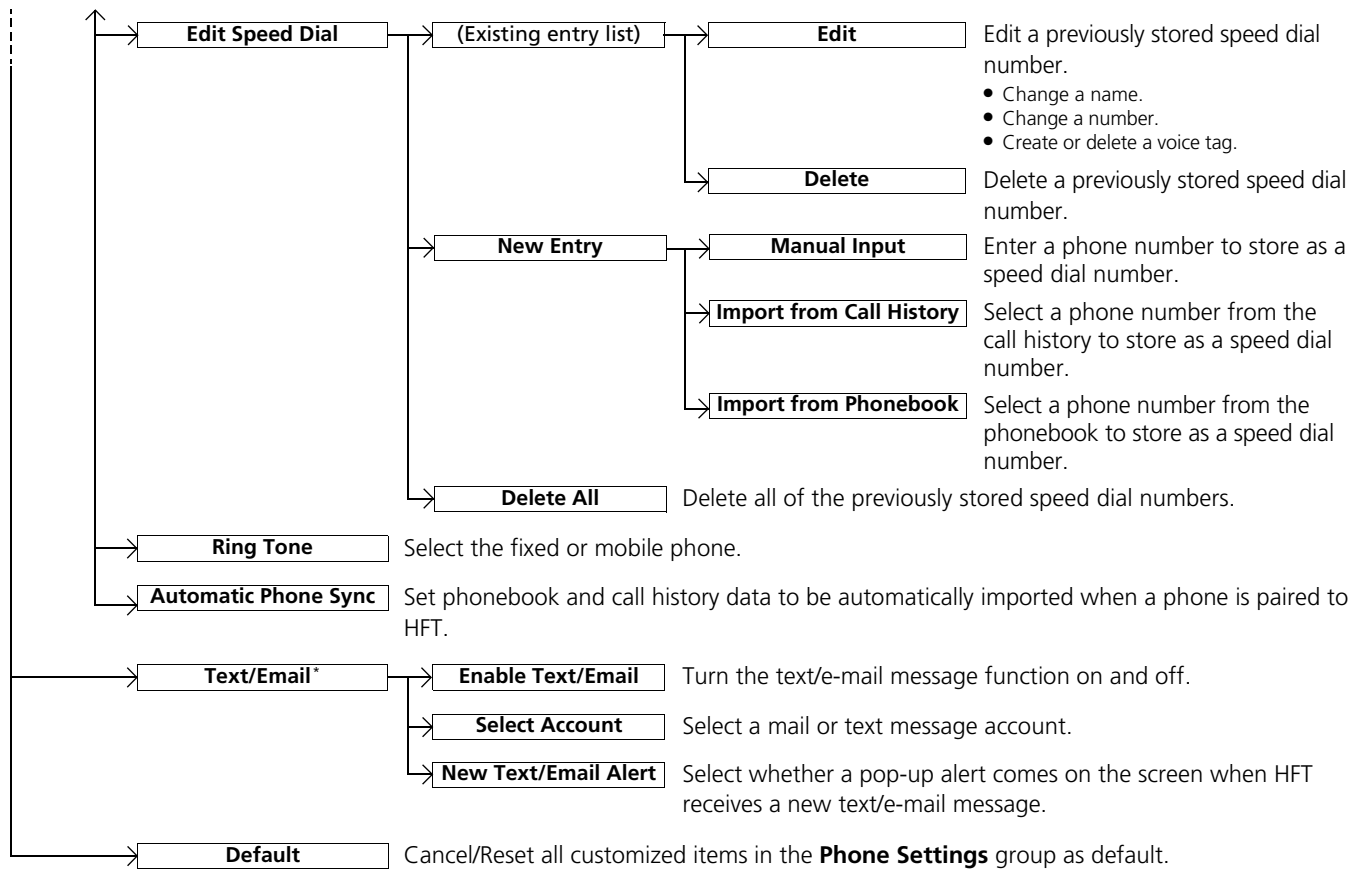

■ Phone Menu screen



1. Select .
2. Select **MENU**.

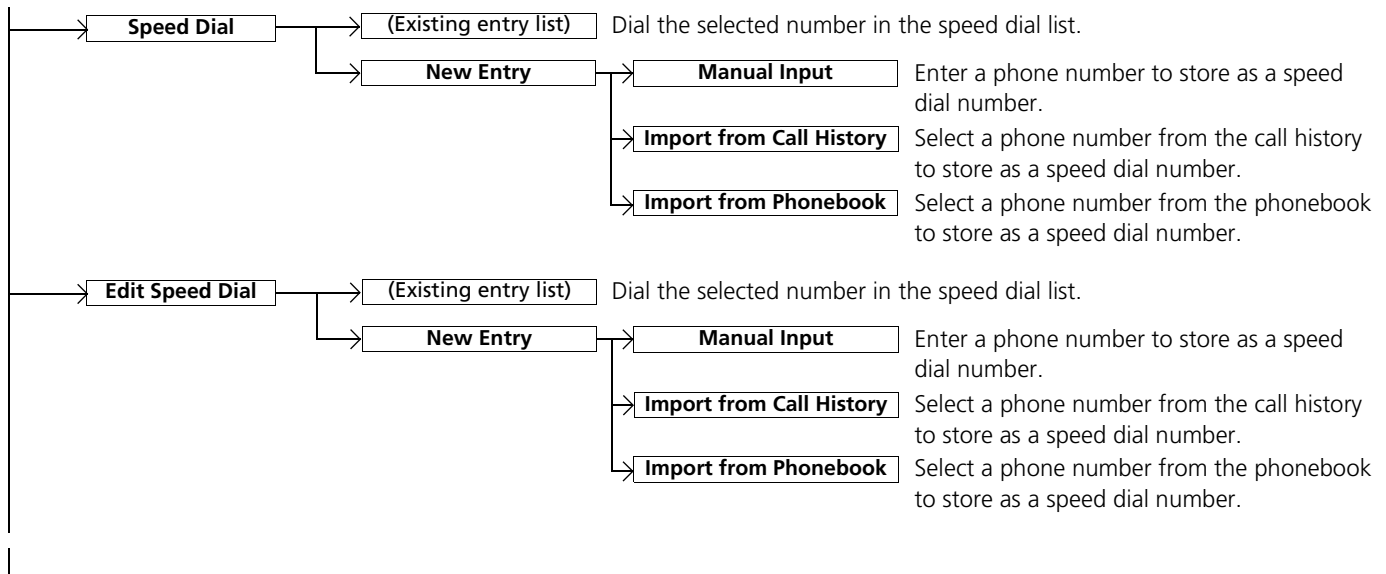

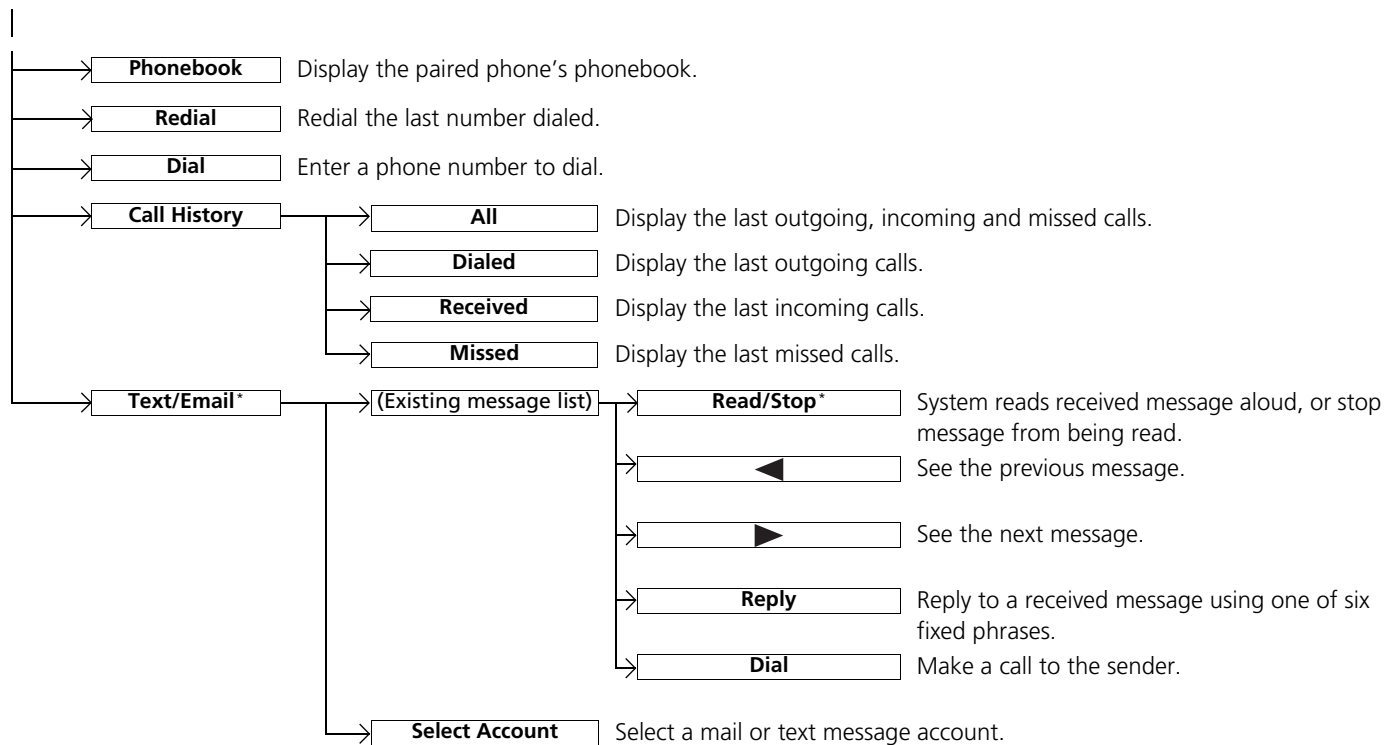

Phone Setup

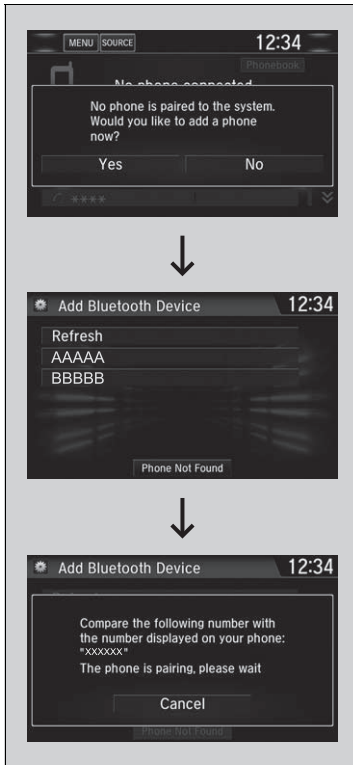

■ To pair a mobile phone (when there is no phone paired to the system)

1. Select .
2. Select **Yes**.
3. Make sure your phone is in search or discoverable mode, then select **Continue**.
 - ▶ HFT automatically searches for a *Bluetooth*® device.
4. Select your phone when it appears on the list.
 - ▶ If your phone does not appear, you can select **Refresh** to search again.
 - ▶ If your phone still does not appear, select **Phone Not Found** and search for *Bluetooth*® devices using your phone. From your phone, search for **Honda HFT**.
5. The system gives you a pairing code on the audio/information screen.
 - ▶ Confirm if the pairing code on the screen and your phone match. This may vary by phone.

☒ Phone Setup

Your *Bluetooth*-compatible phone must be paired to the system before you can make and receive hands-free calls.

Phone Pairing Tips:

- You cannot pair your phone while the vehicle is moving.
- Up to six phones can be paired.
- Your phone's battery may drain faster when it is paired to the system.
- If your phone is not ready for pairing or not found by the system within three minutes, the system will time out and return to idle.

Once you have paired a phone, you can see it displayed on the screen with one or two icons on the right side.

These icons indicate the following:

: The phone can be used with HFT.

: The phone is compatible with *Bluetooth*® Audio.

If there is an active connection to Apple CarPlay, pairing of additional *Bluetooth*-compatible devices is unavailable and **Add Bluetooth Device** is greyed out from the **Bluetooth Device List** screen.



■ **To change the currently paired phone**

1. Go to the **Phone Settings** screen.
 - ▶ **Phone Settings screen** P. 465
2. Select **Bluetooth Device List**.
3. Select a phone to connect.
 - ▶ HFT disconnects the connected phone and starts searching for another paired phone.
4. Select **Connect** , **Connect** , or **Connect** .

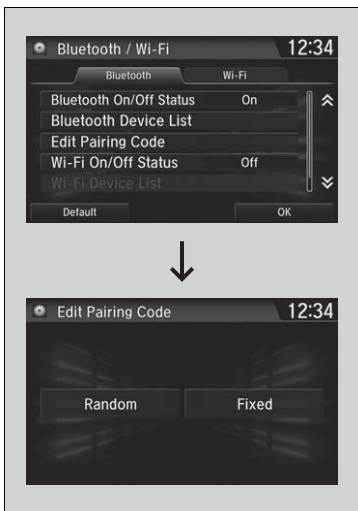

■ **To change the pairing code setting**

1. Select .
2. Select **Settings**.
3. Select **Bluetooth / Wi-Fi**.
4. Select the **Bluetooth** tab.
5. Select **Edit Pairing Code**.
6. Select **Random** or **Fixed**.

▶▶ To change the currently paired phone

If no other phones are found or paired when trying to switch to another phone, HFT will inform you that the original phone is connected again.

To pair other phones, select **Add Bluetooth Device** from the **Bluetooth Device List** screen.

▶▶ To change the pairing code setting

The default pairing code is **0000** until you change the setting.

To create your own, select **Fixed**, and delete the current code, then enter a new one.

For a randomly generated pairing code each time you pair a phone, select **Random**.

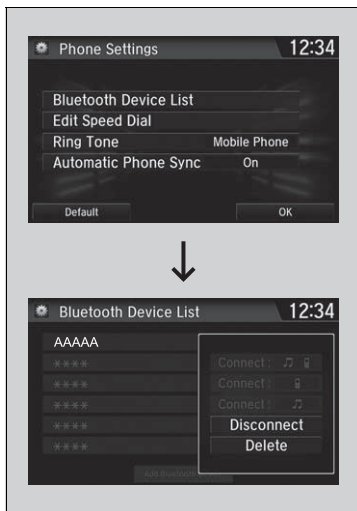

■ To delete a paired phone

1. Go to the **Phone Settings** screen.
▶ **Phone Settings** screen P. 465
2. Select **Bluetooth Device List**.
3. Select a phone you want to delete.
4. Select **Delete**.
5. A confirmation message appears on the screen. Select **Yes**.

■ To Set Up Text/E-mail Message Options *

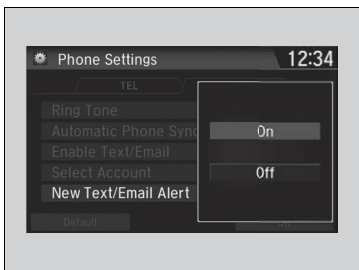
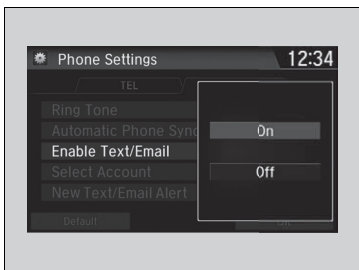

■ To turn on or off the text/e-mail message function

1. Go to the **Phone Settings** screen.
 - ▶ **Phone Settings screen** P. 465
2. Select the **Text/Email** tab, then **Enable Text/Email**.
 - ▶ A pop-up menu appears on the screen.
3. Select **On** or **Off**.

■ To turn on or off the text/e-mail message notice

1. Go to the **Phone Settings** screen.
 - ▶ **Phone Settings screen** P. 465
2. Select the **Text/Email** tab, then **New Text/Email Alert**.
 - ▶ A pop-up menu appears on the screen.
3. Select **On** or **Off**.

☒ To Set Up Text/E-mail Message Options *

To use the text/e-mail message function, it may be necessary to set up on your phone.

Some text/e-mail message features may not be available depending on a mobile phone.

☒ To turn on or off the text/e-mail message notice

- On:** A pop-up notification comes on every time you receive a new message.
- Off:** The message you receive is stored in the system without notification.

Ring Tone

You can change the ring tone setting.

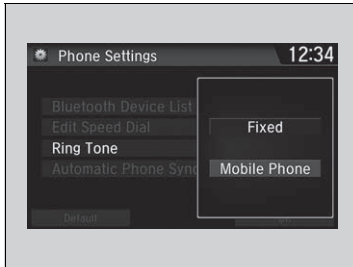

1. Go to the **Phone Settings** screen.
▶ **Phone Settings** screen P. 465
2. Select **Ring Tone**.
3. Select **Fixed** or **Mobile Phone**.

▶▶ Ring Tone

Fixed: The fixed ring tone sounds from the speakers.
Mobile Phone: For certain connected phones, the ring tone stored in the phone sounds from the speakers.

Continued

■ Automatic Import of Cellular Phonebook and Call History

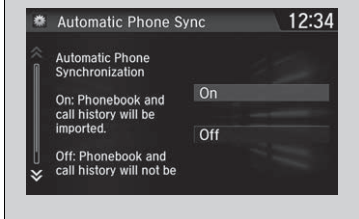
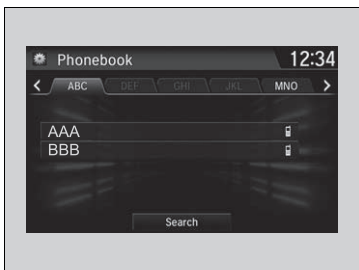

■ When Automatic Phone Sync is set to On:

When your phone is paired, the contents of its phonebook and call history are automatically imported to the system.

■ Changing the Automatic Phone Sync setting

1. Go to the **Phone Settings** screen.
 - ▶ **Phone Settings** screen P. 465
2. Select **Automatic Phone Sync**.
3. Select **On** or **Off**.

▶▶ Automatic Import of Cellular Phonebook and Call History

When you select a name from the list in the cellular phonebook, you can see up to three category icons. The icons indicate what types of numbers are stored for that name.

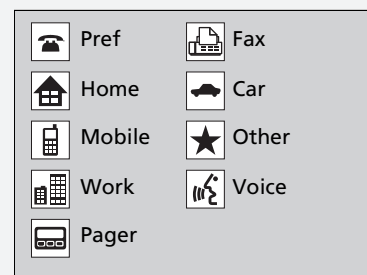

On some phones, it may not be possible to import the category icons to the system.

The phonebook is updated after every connection. Call history is updated after every connection or call.

Speed Dial

Up to 20 speed dial numbers can be stored per phone.

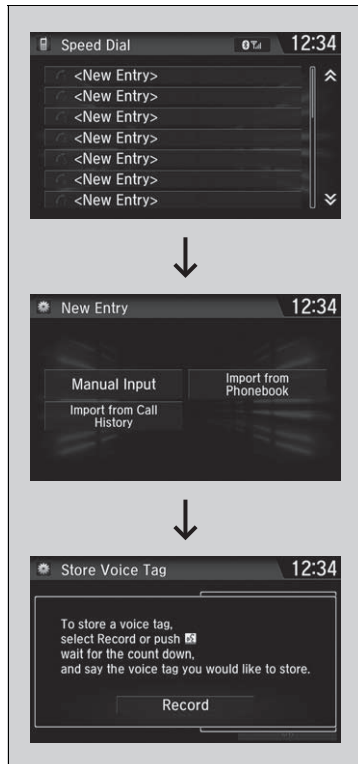

To store a speed dial number:

- Go to the **Phone Menu** screen.
 - ▶ **Phone Menu screen** P. 467
- Select **Speed Dial**.
- Select **New Entry**.
 - From **Import from Call History**:
 - ▶ Select a number from the call history.
 - From **Manual Input**:
 - ▶ Input the number manually.
 - From **Import from Phonebook**:
 - ▶ Select a number from the connected mobile phone's imported phonebook.
- When the speed dial is successfully stored, you are asked to create a voice tag for the number. Select **Yes** or **No**.
- Select **Record**, or use the  button and follow the prompts to complete the voice tag.

Speed Dial

When a voice tag is stored, press the  button to call the number using the voice tag. Say the voice tag name.

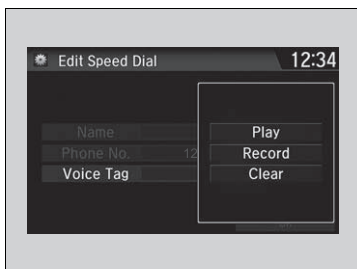
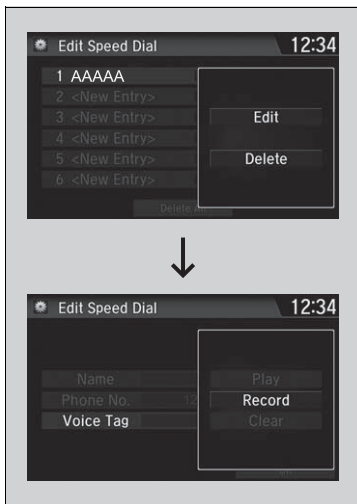

■ **To add a voice tag to a stored speed dial number**

1. Go to the **Phone Settings** screen.
 - ▶ **Phone Settings screen** P. 465
2. Select **Edit Speed Dial**.
3. Select an existing speed dial entry.
 - ▶ From the pop-up menu, select **Edit**.
4. Select **Voice Tag**.
 - ▶ From the pop-up menu, select **Record**.
5. Select **Record**, or use the  button and follow the prompts to complete the voice tag.

■ **To delete a voice tag**

1. Go to the **Phone Settings** screen.
 - ▶ **Phone Settings screen** P. 465
2. Select **Edit Speed Dial**.
3. Select an existing speed dial entry.
 - ▶ From the pop-up menu, select **Edit**.
4. Select **Voice Tag**.
 - ▶ From the pop-up menu, select **Clear**.
5. A confirmation message appears on the screen. Select **Yes**.

▶▶ Speed Dial

Avoid using duplicate voice tags.
 Avoid using "home" as a voice tag.
 It is easier for the system to recognise a longer name.
 For example, use "John Smith" instead of "John."

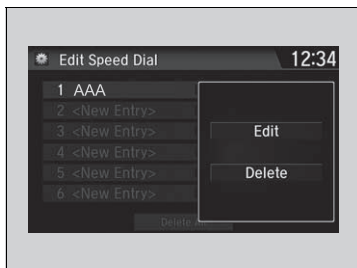

■ To edit a speed dial

1. Go to the **Phone Settings** screen.
▶ **Phone Settings screen** P. 465
2. Select **Edit Speed Dial**.
3. Select an existing speed dial entry.
▶ From the pop-up menu, select **Edit**.
4. Select a setting you want.

■ To delete a speed dial

1. Go to the **Phone Settings** screen.
▶ **Phone Settings screen** P. 465
2. Select **Edit Speed Dial**.
3. Select an existing speed dial entry.
▶ From the pop-up menu, select **Delete**.
4. A confirmation message appears on the screen. Select **Yes**.

■ Phonebook Phonetic Modification *

Add phonetic modifications or a new voice tag to the phone's contact name so that it is easier for HFT to recognize voice commands.

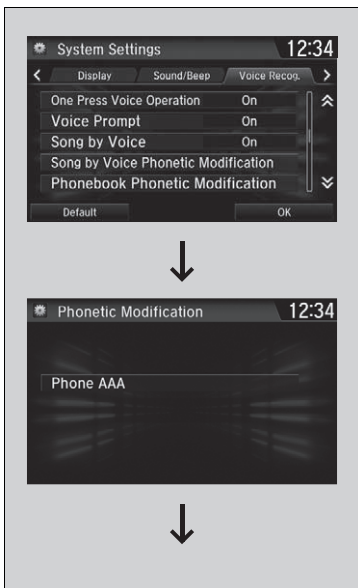

■ To add a new voice tag

1. Select .
2. Select **Settings**.
3. Select **System**.
4. Select the **Voice Recog.** tab.
5. Select **Phonebook Phonetic Modification**.
6. Select the phone you want to add phonetic modification to.

▶▶ Phonebook Phonetic Modification *

You can store up to 20 phonetic modification items.



7. Select **New Voice Tag**.
8. Select a contact name you want to add to.
 - ▶ The pop-up menu appears on the screen.
9. Select **Modify**.
10. Using **Record** or the  button, follow the prompts to complete the voice tag.
11. You will receive a confirmation message on the screen, then select **OK**.

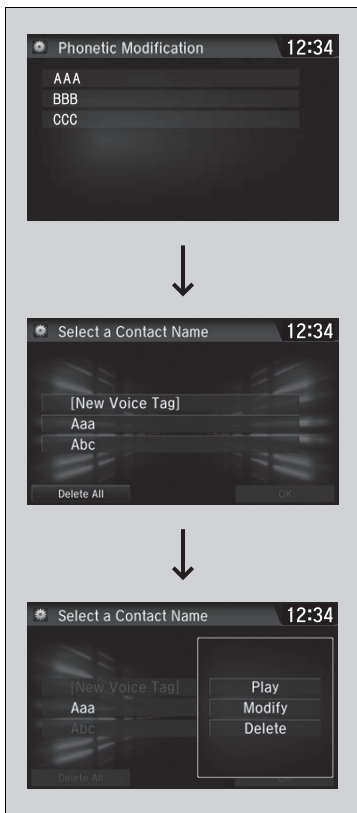

■ **To modify a voice tag**

1. Select .
2. Select **Settings**.
3. Select **System**.
4. Select the **Voice Recog.** tab.
5. Select **Phonebook Phonetic Modification**.
6. Select the phone you want to modify phonetic modification.
7. Select a contact name you want to modify.
 - ▶ The pop-up menu appears on the screen.
8. Select **Modify**.
9. Using **Record** or the button, follow the prompts to complete the voice tag.
10. You will receive a confirmation message on the screen, then select **OK**.

▶▶ Phonebook Phonetic Modification *

You can only modify or delete contact names for the currently connected phone.

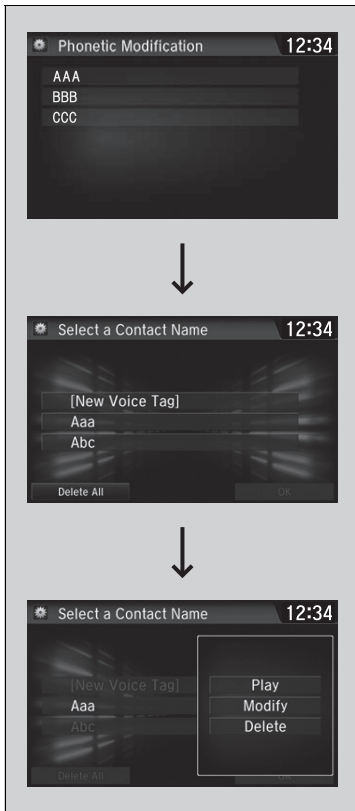

■ To delete a modified voice tag

1. Select .
2. Select **Settings**.
3. Select **System**.
4. Select the **Voice Recog.** tab.
5. Select **Phonebook Phonetic Modification**.
6. Select the phone you want to delete phonetic modification.
7. Select a contact name you want to delete.
 - ▶ The pop-up menu appears on the screen.
8. Select **Delete**.
 - ▶ The selected contact name has been selected.
9. Select **OK**.

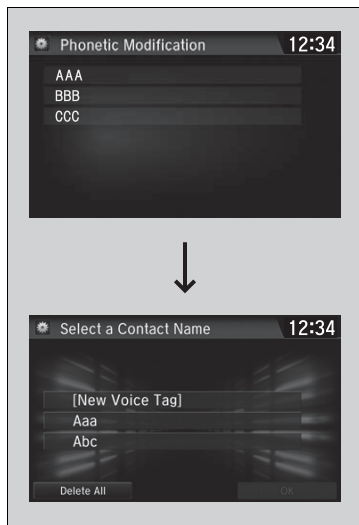

■ To delete all modified voice tags

1. Select .
2. Select **Settings**.
3. Select **System**.
4. Select the **Voice Recog.** tab.
5. Select **Phonebook Phonetic Modification**.
6. Select the phone you want to delete phonetic modification.
 - ▶ The contact name list appears.
7. Select **Delete All**.
8. You will receive a confirmation message on the screen, then select **Yes**.

▶▶ Making a Call

Any voice-tagged speed dial entry can be dialed by voice from most screens.

Press the  button and say the voice tag name.

Once a call is connected, you can hear the voice of the person you are calling through the audio speakers.

While there is an active connection with Apple CarPlay, phone calls can be made only from Apple CarPlay.



■ Making a Call

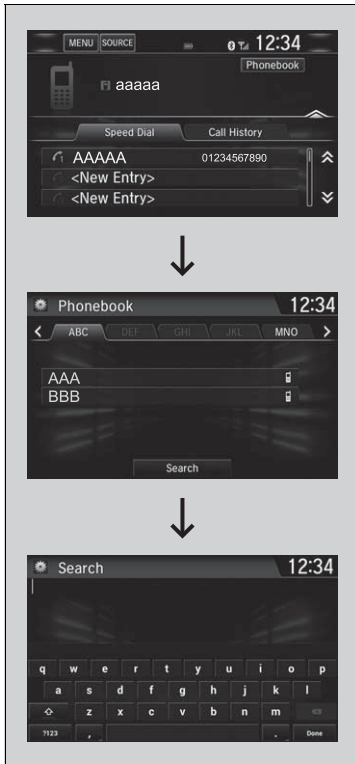

You can make calls by inputting any phone number, or by using the imported phonebook, call history, speed dial entries, or redial.



■ To make a call using the imported phonebook

1. Select .
2. Select **Phonebook**.
3. Select a name.
 - ▶ You can also search by letter. Select **Search**.
 - ▶ Use the keyboard on the touch screen for entering name, if multiple numbers exist select a number.
 - ▶ You can also swipe up or down to scroll through the list of contacts alphabetically on the steering wheel.
4. Select a number.
 - ▶  **Audio Remote Controls** P. 302
 - ▶ Dialing starts automatically.

☒ To make a call using the imported phonebook

You can also select **Phonebook** on the **Phone Menu** screen.

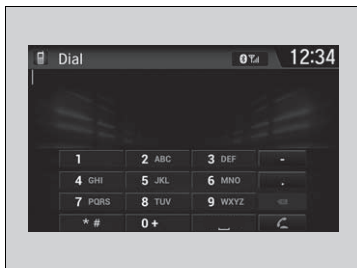

■ **To make a call using a phone number**

1. Go to the **Phone Menu** screen.
 - ▶ **Phone Menu screen** P. 467
2. Select **Dial**.
3. Select a number.
 - ▶ Use the keyboard on the touch screen for entering numbers.
4. Select .
 - ▶ Dialing starts automatically.

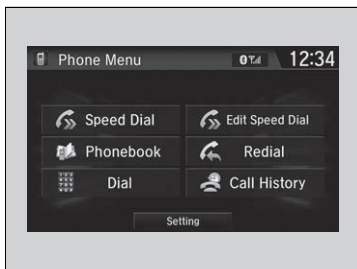

■ **To make a call using redial**

1. Go to the **Phone Menu** screen.
 - ▶ **Phone Menu screen** P. 467
2. Select **Redial**.
 - ▶ Dialing starts automatically.

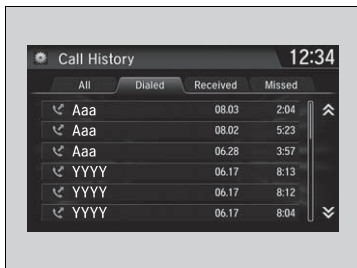

■ **To make a call using the Call History**
Call history is stored by **All, Dialed, Received, and Missed.**

1. Go to the **Phone Menu** screen.
 - ▶ **Phone Menu screen** P. 467
2. Select **Call History**.
3. Select **All, Dialed, Received, or Missed**.
4. Select a number.
 - ▶ Dialing starts automatically.

▶▶ To make a call using the Call History

The call history displays the last 20 all, dialed, received, or missed calls.
(Appears only when a phone is connected to the system.)



■ To make a call using a Speed Dial entry

1. Go to the **Phone Menu** screen.
 ▶ **Phone Menu screen** P. 467
2. Select **Speed Dial**.
3. Select a number.
 ▶ Dialing starts automatically.

☒ To make a call using a Speed Dial entry

When a voice tag is stored, press the  button to call the number using the voice tag.

▶ **Speed Dial** P. 475

Any voice-tagged speed dial entry can be dialed by voice from any screen.

Press the  button and follow the prompts.

■ Receiving a Call

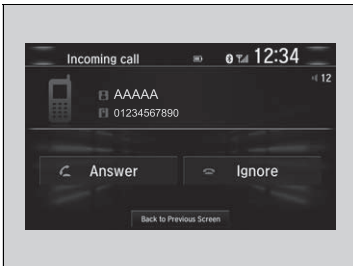

When there is an incoming call, an audible notification sounds (if activated) and the **Incoming call** screen appears.

Press the  button to answer the call.

Press the  button to decline or end the call.

☒ Receiving a Call



Call Waiting

Press the  button to put the current call on hold to answer the incoming call.

Press the  button again to return to the current call.

Select **Ignore** to ignore the incoming call if you do not want to answer it.

Press the  button if you want to hang up the current call.

You can select the icons on the audio/information screen instead of the  and  buttons.

■ Options During a Call

The following options are available during a call.

Mute: Mute your voice.

Transfer: Transfer a call from the system to your phone.

Touch Tones: Send numbers during a call. This is useful when you call a menu-driven phone system.

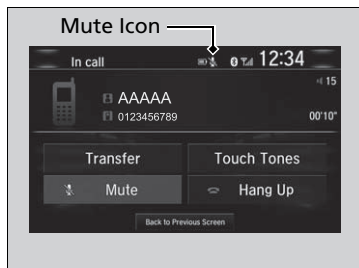

The available options are shown on the lower half of the screen.

Select the option.

- ▶ The mute icon appears when **Mute** is selected. Select **Mute** again to turn it off.

▶▶ Options During a Call

Touch Tones: Available on some phones.

You can select the icons on the audio/information screen.

Receiving a Text/E-mail Message*, *1

HFT can display newly received text or e-mail messages as well as 20 of the most recently received messages on a linked mobile phone. Each received message can be read aloud and replied to using a fixed common phrase.



1. A pop-up appears and notifies you of a new text message or e-mail.
2. Select **Read** to listen to the message.
 - ▶ The text or e-mail message is displayed. The system automatically starts reading out the message.
3. To discontinue the message read-out, select **Stop**.

*1: Message will not be read out depending on the language.

* Not available on all models

Continued

Receiving a Text/E-mail Message*, *1

The system does not display any received messages while you are driving. You can only hear them read aloud.

The system can only receive messages that are sent as text (SMS) messages. Messages sent using data services will not be displayed in the list.

With some phones, you may be able to display up to 20 most recent text and e-mail messages.

Country or local laws may limit your use of the HFT text message/e-mail feature. Only use the text/e-mail message feature when conditions allow you to do so safely.

When you receive a text or e-mail message for the first time since the phone is paired to HFT, you are asked to turn the **New Text/Email Alert** setting to **On**.

- ▶ **To turn on or off the text/e-mail message notice** P. 472

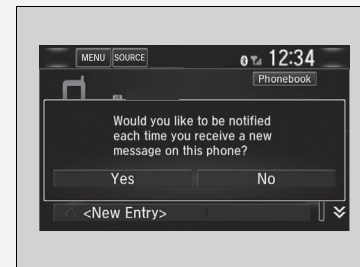

■ Selecting a Mail Account*

If a paired phone has text message or mail accounts, you can select one of them to be active and receive notifications.

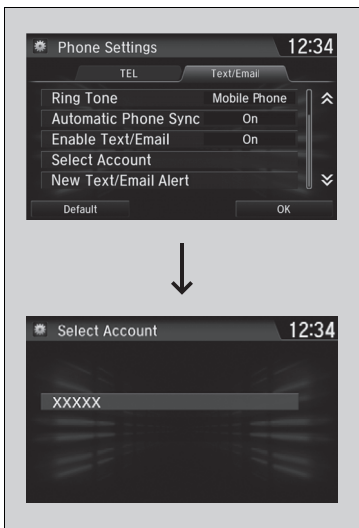

1. Go to the **Phone Settings** screen.
▶ **Phone Settings screen** P. 465
2. Select the **Text/Email** tab, then **Select Account**.
▶ A pop-up menu appears on the screen.
3. Select **Text Messages** or an e-mail message account you want.

▶▶ Selecting a Mail Account*

You can also select a mail account from the folder list screen or the message list screen.

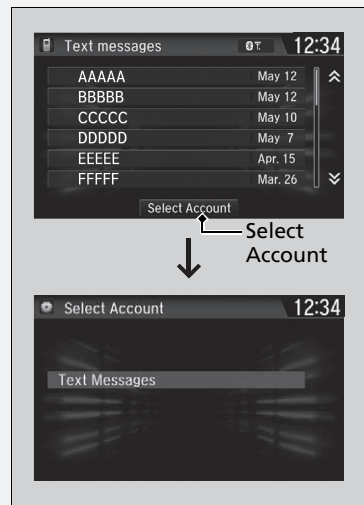

You can only receive notifications from one text message or mail account at a time.

Displaying Messages*, *1



■ Displaying text messages

1. Go to the **Phone Menu** screen.
 ▶ **Phone Menu screen** P. 467
2. Select **Text/Email**.
 ▶ Select account if necessary.
3. Select a message.
 ▶ The text message is displayed. The system automatically starts reading the message aloud.

☒ Displaying Messages*, *1

The ☒ icon appears next to an unread message.

If you delete a message on the phone, the message is also deleted in the system. If you send a message from the system, the message goes to your phone's mailbox.

To see the previous or next message, select ◀ (previous) or ▶ (next) on the message screen.

*1: Message will not be read out depending on the language.

* Not available on all models

Continued

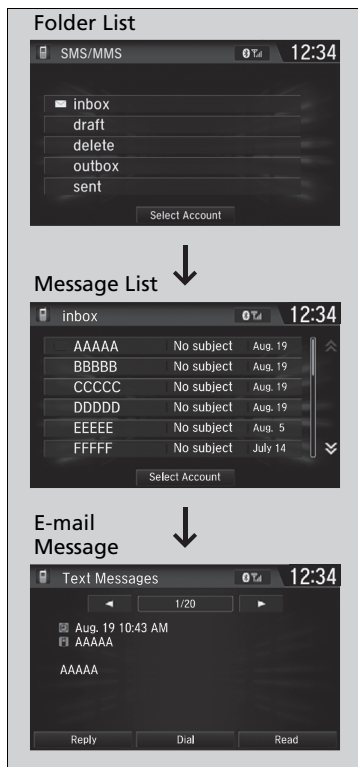

■ Displaying e-mail messages

1. Go to the **Phone Menu** screen.
 - ▶ **Phone Menu screen** P. 467
2. Select **Text/Email**.
 - ▶ Select **Select Account** if necessary.
3. Select a folder.
4. Select a message.
 - ▶ The e-mail message is displayed. The system automatically starts reading the message aloud.

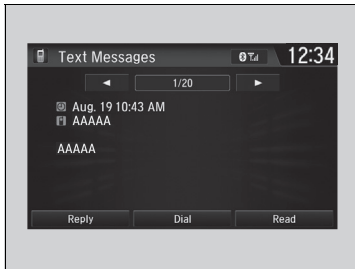

■ Read or Stop reading a message

1. Go to the text or e-mail message screen.
 - ▶ The system automatically starts reading the message aloud.
 - **Displaying Messages***, *1 P. 489
2. Select **Stop** to stop reading.
 - Select **Read** again to start reading the message from the beginning.



■ Reply to a message

1. Go to the text or e-mail message screen.
 - ▶ The system automatically starts reading the message aloud.
 - **Displaying Messages***, *1 P. 489
2. Select **Reply**.
3. Select the reply message.
 - ▶ The pop-up menu appears on the screen.
4. Select **Send** to send the message.
 - ▶ **Message sent** appears on the screen when the reply message was successfully sent.

☒ Reply to a message

The available fixed reply messages are as follows:

- **Talk to you later, I'm driving.**
- **I'm on my way.**
- **I'm running late.**
- **OK**
- **Yes**
- **No**

You cannot add, edit, or delete reply messages.

Only certain phones receive and send messages when paired and connected. For a list of compatible phones ask a dealer.

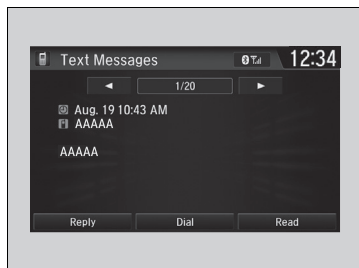

■ **Making a call to a sender**

1. Go to the text message screen.
2. Select **Dial**.

Automatic emergency call



If your vehicle is involved in a collision, the SRS unit in the vehicle will attempt to connect to a Public Safety Answering Point (PSAP) operator. Once a connection is established, various information about the vehicle will be sent to a PSAP operator with whom you will be able to speak. This information includes:

- Vehicle identification number (VIN)
- Type of vehicle (passenger vehicle or light-weight commercial vehicle)
- Type of energy stored for vehicle propulsion (gasoline/diesel/CNG/LPG/electricity/hydrogen)
- Last three locations of the vehicle
- Direction of travel
- Triggering mode (automatic or manual)
- Timestamp

When an emergency call is initiated, the vehicle speakers are disabled so that you can hear the operator.

When the ignition is turned on. The eCall indicator lights up in green for 1 second, then in red for 1 second.

Emergency Call (eCall)*

Your vehicle is equipped with the 112-based eCall service system.

The 112-based eCall service is a public service of general interest and is accessible free of charge.

The 112-based eCall in-vehicle system is activated when the ignition is turned on. In the event of a collision, the system will determine the degree of the impact based on information collected from the on-board sensors and, depending on the severity of the collision, will initiate the emergency call.

The 112-based eCall in-vehicle system can also be triggered manually, if needed.

Manual emergency call P. 495

Any processing of personal data through the 112-based eCall in-vehicle system shall comply with the personal data protection rules provided for in Directives 95/46/EC (replaced by 2016/679/EC) and 2002/58/EC, and in particular, shall be based on the necessity to protect the vital interests of the individuals in accordance with Article 7(d) of Directive 95/46/EC (replaced by 2016/679/EC).

Processing of such data is strictly limited to the purpose of for which the single European emergency number 112 is designated.

If the eCall system is working properly, the indicator will light up in green.

- Green: eCall system is ready.
- Blinking in green: eCall system is connected and making an eCall to a PSAP operator.
- Repeating a pattern of short flashes of the red light: The eCall system has failed to connect to an operator. The eCall indicator will continue this pattern for 30 seconds, then it will light up in green.

If the 112-based eCall system is disabled in the event of a critical system failure, the following warning will be given to the occupants of the vehicle:

- Red or blacked out: A problem with the eCall system has occurred. If the indicator stays red or blacked out even after you have restarted the vehicle, have the system check by a dealer.
- Blinking in red: The level of the backup battery is too low. While the power is in ON, the battery undergoes recharging. Once the battery has been recharged to a certain level, the eCall indicator lights up in green.

📞 Emergency Call (eCall)*

Recipients of data processed by the 112-based eCall in-vehicle system are the relevant public safety answering points designated by the respective public authorities of the country in which they are located and are the first to receive and for which the single European emergency number 112 is designated.

Your vehicle may NOT be able to connect to a PSAP operator if:

- both the 12V battery and backup battery are too low.
- your vehicle is in an area without adequate cellular coverage.
- There is a problem with the eCall system itself or its peripheral equipment such as the microphone or speakers.

The backup battery is designed to operate for at least 3 years, after which it may need to be replaced.

The backup battery is not available for direct purchase. For replacement, visit a dealer.

Manual emergency call

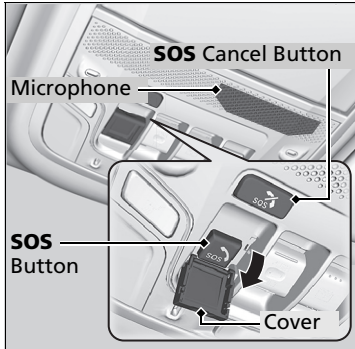

If you need to make an emergency call, you can establish a connection manually: Press the **SOS** button and hold it for more than 0.5 seconds.

To cancel a call, press the **SOS** cancel button for more than 0.5 seconds, before 5 seconds has elapsed since the **SOS** button was pressed.

The **SOS** button is protected by a cover. Open the cover to gain access.

When an emergency call is initiated, the vehicle speakers are disabled so that you can hear the operator.

Manual emergency call

Do NOT press the button while you are driving. If you need to contact an operator, park the vehicle in a safe place before you make a call.

If the eCall system at first fails to connect to a PSAP operator, it will try again until a connection is established. However, if 2 minutes have elapsed since the first try was attempted, the system will no longer attempt to establish a connection.

The **SOS** cancel button does not cancel a call once the system is connected to an operator.

►► Emergency Call (eCall)*

Data privacy

The 112-based eCall in-vehicle system is designed to ensure that:

- Data contained in the system memory is not available outside the system before an eCall is triggered.
- It is not traceable or subject to any constant tracking during its normal operation status.
- Data in the internal memory of the system is automatically and continuously removed.

For the system to function normally, the vehicle location data is constantly overwritten in the internal memory of the system so that the last three locations of the vehicle are kept up-to-date.

The log of activity data in the 112-based eCall in-vehicle system is kept for no longer than necessary for attaining the purpose of handling the emergency eCall and in any case not beyond 13 hours from the moment an emergency eCall was initiated.

☒ Emergency Call (eCall)*

Owner's rights

The data subject (the vehicle's owner) has a right of access to data and as appropriate to request the rectification, erasure or blocking of data, concerning him or her, the processing of which does not comply with the provisions of Directive 95/46/EC (replaced by 2016/679/EC).

Any third parties to whom the data have been disclosed have to be notified of such rectification, erasure or blocking carried out in compliance with this Directive, unless it proves impossible or involves a disproportionate effort.

The data subject has a right to complain to the competent data protection authority if he or she considers that his or her rights have been infringed as a result of the processing of his or her personal data.

Honda eCall Service Information:

If you have any questions about eCall, contact the office relevant to the country in which you reside. See the service booklet for list of offices.

* Not available on all models

Driving



This chapter discusses driving and refueling.

Before Driving	500
Towing a Trailer	504
Off-road Guidelines	512
When Driving	
Starting the Engine	514
Precautions While Driving.....	520
Continuously Variable Transmission* ...	522
Shifting.....	523, 528
ECON Mode	531
Auto Idle Stop*	532
Adjustable Speed Limiter.....	536
Intelligent Speed Limiter.....	540
Vehicle Stability Assist (VSA) System ...	547
Agile Handling Assist	549

Real Time AWD with Intelligent Control System*	550
Deflation Warning System.....	551
Adjusting Headlight Distribution	554
Blind spot information System*.....	555
Honda Sensing	558
Collision Mitigation Braking System (CMBS)	561
Adaptive Cruise Control (ACC) with Low Speed Follow (LSF)*.....	572
Adaptive Cruise Control (ACC)*.....	589
Lane Keeping Assist System (LKAS) ..	604
Road Departure Mitigation System....	612
Traffic Sign Recognition System	618

Front Sensor Camera	626
Radar Sensor	628
Braking	
Brake System.....	629
Anti-lock Brake System (ABS).....	637
Brake Assist System	638
Emergency Stop Signal	639
Parking Your Vehicle	
When Stopped	640
Parking Sensor System*	641
Cross Traffic Monitor*	646
Multi-View Rear Camera*	651
Refueling	653
Fuel Economy and CO₂ Emissions	655
Turbo Engine Vehicle	656

* Not available on all models

Driving Preparation

Check the following items before you start driving.

Exterior Checks

- Make sure there are no obstructions on the windows, door mirrors, exterior lights, or other parts of the vehicle.
 - ▶ Remove any frost, snow, or ice.
 - ▶ Remove any snow on the roof, as this can slip down and obstruct your field of vision while driving. If frozen solid, remove ice once it has softened.
 - ▶ When removing ice from around the wheels, be sure not to damage the wheel or wheel components.
- Make sure the bonnet is securely closed.
 - ▶ If the bonnet opens while driving, your front view will be blocked.
- Make sure the tyres are in good condition.
 - ▶ Check air pressures, check for damage and excessive wear.
 - ✦ **Checking and Maintaining Tyres** P. 707
- Make sure there are no people or objects behind or around the vehicle.
 - ▶ There are blind spots from the inside.

Exterior Checks

NOTICE

When doors are frozen shut, use warm water around the door edges to melt any ice. Do not try to force them open, as this can damage the rubber trim around the doors. When done, wipe dry to avoid further freezing.

Do not pour warm water into the key cylinder. You will be unable to insert the key if the water freezes in the hole.

Heat from the engine and exhaust can ignite flammable materials left under the bonnet, causing a fire. If you've parked your vehicle for an extended period, inspect and remove any debris that may have collected, such as dried grass and leaves that have fallen or have been carried in for use as a nest by a small animal. Also check under the bonnet for leftover flammable materials after you or someone else has performed maintenance on your vehicle.

Interior Checks

- Store or secure all items on board properly.
 - ▶ Carrying too much luggage, or improperly storing it, can affect your vehicle's handling, stability, stopping distance, and tyres, and make it unsafe.
 - **Load Limit** P. 503
- Do not pile items higher than the seat height.
 - ▶ They can block your view and may be thrown forward in the event of sudden braking.
- Do not place anything in the front seat footwells. Make sure to secure the floor mat*.
 - ▶ An object or unsecured floor mat can interfere with your brake and accelerator pedal operation while driving.
- If you have any animals on board, do not let them move around in the vehicle.
 - ▶ They may interfere with driving and a crash could occur.
- Securely close all doors and the tailgate.
- Adjust your seating position properly.
 - ▶ Adjust the head restraint, too.
 - **Adjusting the Seats** P. 249
 - **Adjusting the Front Head Restraints** P. 262
- Adjust the mirrors and steering wheel properly for your driving.
 - ▶ Adjust them while sitting in the proper driving position.
 - **Adjusting the Mirrors** P. 245
 - **Adjusting the Steering Wheel** P. 244

Interior Checks

The headlight aim is set by the factory, and does not need to be adjusted. However, if you regularly carry heavy items in the luggage area or tow a trailer, have the aiming readjusted at a dealer or by a qualified technician.

Your vehicle is equipped with the automatic headlight adjusting system that automatically adjusts the vertical angle of the low beam headlights.

- Be sure items placed on the floor behind the front seats cannot roll under the seats.
 - ▶ They can interfere with the driver's ability to operate the pedals, or the operation of the seats.
- Everyone in the vehicle must fasten their seat belt.
 - 📄 **Fastening a Seat Belt** P. 49
- Make sure that the indicators in the instrument panel come on when you start the vehicle, and go off soon after.
 - ▶ Always have a dealer check the vehicle if a problem is indicated.
 - 📄 **Indicators** P. 98

Load Limit

When you load luggage, the total weight of the vehicle, all passengers, and luggage must not exceed the maximum permissible weight.

📄 **Specifications** P. 770

The load for the front and rear axles also must not exceed the maximum permissible axle weight.

📄 **Specifications** P. 770

⚠ Load Limit

⚠ WARNING

Overloading or improper loading can affect handling and stability and cause a crash in which you can be hurt or killed.

Follow all load limits and other loading guidelines in this manual.

Towing Preparation

Towing Load Limits

Your vehicle can tow a trailer if you carefully observe the load limits, use the proper equipment, and follow the towing guidelines. Check the load limits before driving.

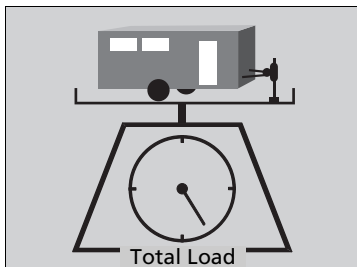

■ Total trailer weight

Do not exceed the maximum towing weight of the trailer and towbar (with/without brakes), luggage and everything in or on it.

Towing loads in excess of the maximum towing weight can seriously affect vehicle handling and performance and can damage the engine and drivetrain.

» Towing Load Limits

⚠ WARNING

Exceeding any load limit or improperly loading your vehicle and trailer can cause a crash in which you can be seriously hurt or killed.

Check the loading of your vehicle and trailer carefully before starting to drive.

Check if all loads are within limits at a public scale. If a public scale is not available, add the estimated weight of your luggage load to the weight of your trailer (as quoted by the manufacturer), and then measure the tongue load with an appropriate scale or tongue gauge or estimate it based on luggage distribution. Refer to the trailer owner's manual for additional information.

Break-in Period

Avoid towing a trailer during your vehicle's first 1,000 km (625 miles).

If you tow a trailer in mountainous conditions, remember to reduce 10% of the combined vehicle and trailer weights from the maximum towing weight for every 1,000 metres of elevation.

Never exceed the maximum towing weight and specified load limit.

▣ Specifications P. 770

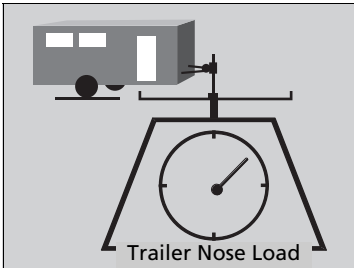

■ Trailer nose load

The trailer nose load should never exceed 100 kg (220 lbs). This is the amount of weight the trailer puts on the towbar when it is fully-loaded. As a rule of thumb for trailer weights of less than 1,000 kg (2,205 lbs), the trailer nose load should be 10 percent of the total trailer package.

- Excessive trailer nose load reduces front tyre traction and steering control. Too little trailer nose load can make the trailer unstable and cause it to sway.
- To achieve a proper trailer nose load, start by loading 60% of the load toward the front of the trailer and 40% toward the rear. Readjust the load as needed.

■ Towing Equipment and Accessories

Towing equipment varies by the size of your trailer, how much load you are towing, and where you are towing.

■ Towbars

The towbar must be of an approved type and properly bolted to the underbody.

■ Safety chains

Always use safety chains when you tow a trailer. Leave enough slack to allow the trailer to turn corners easily, but do not allow the chains to drag on the ground.

■ Trailer brakes

If you are thinking of getting a trailer that has brakes, be sure they are electronically actuated. Do not attempt to tap into your vehicle's hydraulic system. No matter how successful it may seem, any attempt to attach trailer brakes to your vehicle's hydraulic system will lower braking effectiveness and create a potential hazard.

■ Additional towing equipment

There may be laws requiring special outside mirrors when towing a trailer. Even if mirrors are not required in your locale, you should install special mirrors if visibility is restricted in any way.

► Towing Equipment and Accessories

Make sure that all equipment is properly installed and maintained, and that it meets the regulations of the country where you are driving.

Consult your trailer maker for proper installation and setup of the equipment. Improper installation and setup can affect the handling, stability, and braking performance of your vehicle.

Consult your trailer sales or rental agency if any other items are recommended or required for your towing situation.

■ Trailer light

Trailer lights and equipment must comply with the regulations of the country where you are driving. Check with your local trailer sales or rental agency for the requirements in the area where you plan to tow.

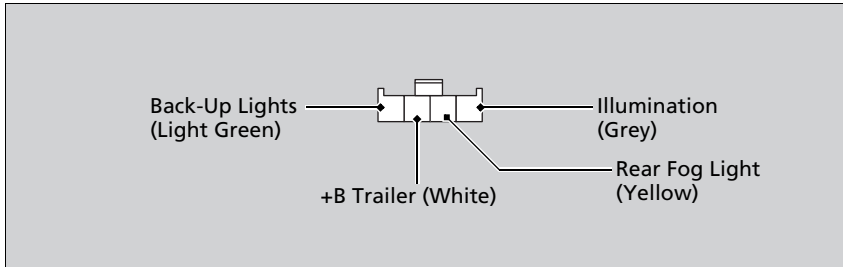

We recommend that you have a dealer install a Honda wiring harness and converter. They are designed for your vehicle.

☒ Towing Equipment and Accessories

The lighting and wiring of trailers can vary by type and brand. If a connector is required, it should only be installed by a qualified technician.

Trailer Stability Assist

Helps to stabilise the vehicle and trailer when the trailer severely sways.

■ How trailer stability assist works

When the vehicle and trailer become unstable while driving, trailer stability assist determines the cause. If the trailer oscillation is detected as the cause, and the swaying increases, the system applies the brakes or controls engine output to reduce vehicle speed.

Both the vehicle and trailer brake lights come on automatically if you brake to reduce vehicle speed.

▶ Trailer Stability Assist

Trailer stability assist is not a function that prevents the vehicle and trailer from swaying. Avoid high speeds, abrupt steering, improper trailer load, and sudden braking to keep the trailer from swaying. When swayed too severely, the system becomes ineffective, and you may lose control of your vehicle, causing the trailer to roll over or get damaged.

▶ **Driving Safely with a Trailer** P. 509

Trailer towing sway is caused by:

- Crosswinds
- Improper towbar down load
- Excessive Speed

The VSA system indicator blinks during the trailer stability assist operation.

▶ **VSA Operation** P. 547

Driving Safely with a Trailer

■ Things You Need To Know Before Towing a Trailer

- Have the trailer properly serviced and keep it in good condition.
- Make sure that all the weights and load in the vehicle and trailer are within limits.
 - ▣ **Towing Load Limits** P. 504
- Securely attach the tow bar, safety chains, and other necessary parts to the trailer.
- Securely store all the items in and on the trailer so that they do not shift while driving.
- Check if the lights and brakes on the trailer are working properly.
- Check the pressures of the trailer tyres, including the spare.
- Check regulations concerning the maximum speed or driving restrictions for vehicles towing trailers. If you are driving across several countries, check each country's requirements before leaving home, because regulations may vary.

Models with Auto Idle Stop

- Turn off the Auto Idle Stop system using Auto Idle Stop **OFF** button. The trailer weight can affect your vehicle's brake effectiveness if Auto Idle Stop is activated on a hill while towing a trailer.

▣ Driving Safely with a Trailer

Operating speed when towing a trailer must not exceed 100 km/h (62 mph).

Parking

In addition to the normal precautions, place wheel chocks at each of the trailer's tyres.

We recommend you drive uphill of less than 12% slope. Follow the trailer association's recommendations for suitable roads.

Winds caused by passing large vehicles can sway your trailer, keep a constant speed and steer straight ahead.

Always drive slowly and have someone guide you when reversing.

■ Towing Speeds and Gears

- Drive slower than normal.
- Obey posted speed limits for vehicles with trailers.

Continuously variable transmission models

- Use the **D** position when towing a trailer on level roads.

Manual transmission models

Either shift up or shift down indicator will come on at the best time to shift to a higher or lower gear for the better fuel economy.

▶▶ Towing Speeds and Gears

The shift down indicator will not prompt to downshift to 1st gear. It is up to you to downshift to 1st gear to increase engine braking. Avoid sudden engine braking.

Road and traffic conditions may require you to shift at times other than those indicated.

■ Turning and Braking

- Turn more slowly and with a wider turning arc than normal.
- Allow more time and distance for braking.
- Do not brake or turn suddenly.

■ Driving in Hilly Terrain

- Monitor your temperature gauge. If it nears the white (Hot) mark, turn off the climate control system and reduce speed. Pull to the side of the road safely to cool down the engine if necessary.

Continuously variable transmission models

- Shift to the **[S]** position if the transmission shifts frequently.

General Information

Your vehicle has been designed primarily for use on pavement, however, its higher ground clearance allows you to occasionally travel on unpaved roads. It is not designed for trail-blazing, or other challenging off-road activities.

If you decide to drive on unpaved roads, you will find that it requires somewhat different driving skills and that your vehicle will handle somewhat differently than it does on pavement. Pay attention to the precautions and tips in this section, and get acquainted with your vehicle before leaving the pavement.

Important Safety Precautions

To avoid loss of control or rollover, be sure to follow all precautions and recommendations:

- Be sure to store luggage properly and do not exceed your luggage load limits.
 📖 **Load Limit** P. 503
- Whenever you drive, make sure you and your passengers always wear seat belts.
- Keep your speed low, and never go faster than the conditions allow.
- It's up to you to continually assess the situation and drive within the limits.

📖 Off-road Guidelines

WARNING

Improperly operating this vehicle on or off pavement can cause an accident or rollover in which you and your passengers could be seriously injured or killed.

- Follow all instructions and guidelines in this owner's manual.
- Keep your speed low, and don't drive faster than conditions permit.

Failure to operate your vehicle correctly might result in a crash or a rollover.

- 📖 **Important Handling Information** P. 40
- 📖 **Precautions While Driving** P. 520

Avoiding Trouble

- **Check Out Your Vehicle** before you leave the pavement and make sure that all scheduled maintenance has been completed. Pay special attention to the condition of the tyres, and check the tyre pressures.
- **Remember** the route you choose presents limits (too steep or bumpy), you have limits (driving skill and comfort), and your vehicle has limits (traction, stability, and power). Failing to recognise these limits will likely put you and your passengers in a hazardous situation.
- **Accelerating and Braking** should be done slowly and gradually. Trying to start or stop too fast can cause a loss of traction and you could lose control.
- **Avoiding Obstacles and Debris** in the road reduces the likelihood of a rollover or damage to your suspension or other components.
- **Driving on Slopes** increasing your risk of a rollover, particularly if you attempt to drive across a slope that is too steep. Going straight or down a slope is usually the safest. If you can't clearly see all conditions or obstacles on a slope, walk it before you drive it. If there is any doubt whether you can safely pass, don't try it. Find another route. If you get stuck when climbing, do not try to turn around. Back down slowly following the same route you took up the hill.
- **Crossing a Stream** - Avoid driving through deep water. If you encounter water in your route (a small stream or large puddle, for example), evaluate it carefully before going ahead. Make sure it is shallow, flowing slowly, and has firm ground underneath. If you are not sure of the depth or the ground, turn around and find another route. Driving through deep water can also damage your vehicle. The water can get into the transmission and differential, diluting the lubricant and causing an eventual failure. It can also wash the grease out of the wheel bearings.
- **If You Get Stuck**, carefully go in the direction that you think will get you unstuck. Do not spin the tyres as this will only make things worse and could damage the transmission. If you are unable to free yourself, your vehicle will need to be towed. Front and rear tow hooks are provided for this purpose.

Models without keyless access system

Starting the Engine



1. Make sure the parking brake is applied.
 - ▶ The parking brake and brake system indicator (red) comes on for 15 seconds when you pull up the electric parking brake switch.
 - ▶ The parking brake must be applied to start the engine.

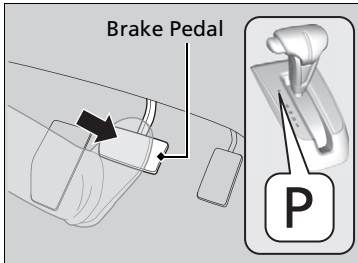

Continuously variable transmission models

2. Check that the shift lever is in **P**, then depress the brake pedal.
 - ▶ Although it is possible to start the vehicle in **N** with the parking brake applied, it is safer to start it in **P**.

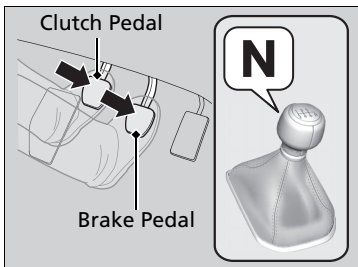

Manual transmission models

2. Check that the shift lever is in **N**. Then depress the brake pedal with your right foot, and the clutch pedal with your left foot.
 - ▶ The clutch pedal must be fully depressed to start the engine.

Starting the Engine

Keep your foot firmly on the brake pedal when starting the engine.

The engine is harder to start in cold weather and in thinner air found at altitudes above 2,400 metres (8,000 feet).

When starting the engine in cold weather, turn off all electrical accessories such as the lights, climate control system, and rear demister in order to reduce battery drain.

If the exhaust system sounds abnormal or you can smell exhaust gas inside the vehicle, have your vehicle checked by a dealer. There may be a problem with the engine or exhaust system.

Manual transmission models

If the vehicle stalls on a slope, the electric parking brake system may automatically engage. If it does not, engage it manually, then start the engine again.

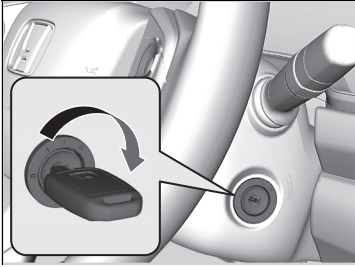
**All models**

3. Turn the ignition switch to START  without depressing the accelerator pedal.

▶▶ Starting the Engine

Do not hold the key in START  for more than 10 seconds.

- If the engine does not start right away, wait for at least 30 seconds before trying again.
- If the engine starts, but then immediately stops, wait at least 30 seconds before repeating step 3 while gently depressing the accelerator pedal. Release the accelerator pedal once the engine starts.

The immobilizer system protects your vehicle from theft. If an improperly coded device is used, the engine's fuel system is disabled.

 **Immobilizer System** P. 204

Starting to Drive

Continuously variable transmission models

1. Keeping your right foot on the brake pedal, put the shift lever in **D**. Select **R** when reversing.
2. With the parking brake applied, release the brake pedal and gently depress the accelerator pedal.
 - ▶ Make sure the parking brake and brake system indicator (red) goes off.

➤ **Parking Brake** P. 629

Hill start assist system

Hill start assist keeps the brake engaged briefly to help to prevent the vehicle from rolling on inclines as you move your foot from the brake pedal to the accelerator.

Continuously variable transmission models

Move the shift lever to **D** or **S** when facing uphill, or **R** when facing downhill, then release the brake pedal.

Manual transmission models

Depress the clutch pedal, and shift to one of the forward gears when facing uphill, or **R** when facing downhill, then release the brake pedal.

Starting to Drive

Manual transmission models

If the engine stalls, fully depress the clutch pedal within three seconds. The engine may automatically restart under certain conditions. Otherwise, follow the standard procedure.

➤ **Starting the Engine** P. 514

You can also release the parking brake by pressing the electric parking brake switch while depressing the brake pedal. When facing downhill, you can start your vehicle more smoothly by manually releasing it with the electric parking brake switch than by releasing it with the accelerator pedal.

Hill start assist system

Hill start assist may not prevent the vehicle from rolling downhill on a very steep or slippery slope, and will not operate on small inclines.

Hill start assist is not a replacement for the parking brake.

Hill start assist will operate even when VSA is switched off.

Models with keyless access system

Starting the Engine

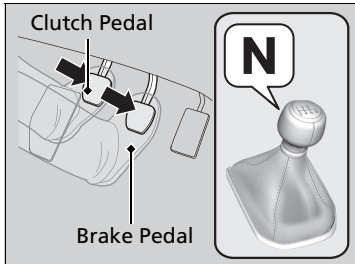
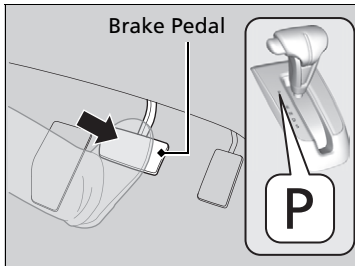
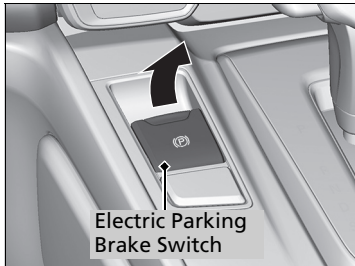

1. Make sure the parking brake is applied.
 - ▶ The parking brake and brake system indicator (red) comes on for 15 seconds when you pull up the electric parking brake switch.
 - ▶ The parking brake must be applied to start the engine.

Continuously variable transmission models

2. Check that the transmission is in **P**, then depress the brake pedal.
 - ▶ Although it is possible to start the vehicle in **N** with the parking brake applied, it is safer to start it in **P**.

Manual transmission models

2. Check that the shift lever is in **N**. Then depress the brake pedal with your right foot, and the clutch pedal with your left foot.
 - ▶ The clutch pedal must be fully depressed to start the engine.

▶▶ Starting the Engine

Keep your foot firmly on the brake pedal when starting the engine.

The engine is harder to start in cold weather and in thinner air found at altitudes above 2,400 metres (8,000 feet).

When starting the engine in cold weather, turn off all electrical accessories such as the lights, climate control system, and rear demister in order to reduce battery drain.

If the exhaust system sounds abnormal or you can smell exhaust gas inside the vehicle, have your vehicle checked by a dealer. There may be a problem with the engine or exhaust system.

Bring the keyless remote close to the **ENGINE START/STOP** button if the battery in the keyless remote is weak.

▶ **If the Keyless Remote Battery is Weak**
P. 744

The engine may not start if the keyless remote is subjected to strong radio waves.

Manual transmission models

If the vehicle stalls on a slope, the electric parking brake system may automatically engage. If it does not, engage it manually, then start the engine again.

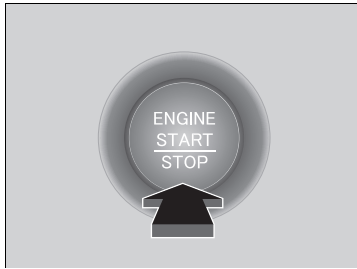

All models

3. Press the **ENGINE START/STOP** button without depressing the accelerator pedal.

Stopping the Engine

You can turn the engine off when the vehicle is completely stopped.

Continuously variable transmission models

1. Put the transmission into **P**.
2. Press the **ENGINE START/STOP** button.

Manual transmission models

- If the shift lever is in **N**, press the **ENGINE START/STOP** button.
- If the shift lever is in any gear other than **N**, depress the clutch pedal, then press the **ENGINE START/STOP** button.

Starting the Engine

Do not hold the **ENGINE START/STOP** button to start the engine. If the engine does not start, wait at least 30 seconds before trying again.

The immobilizer system protects your vehicle from theft. If an improperly coded device is used, the engine's fuel system is disabled.

➤ **Immobilizer System** P. 204

Starting to Drive

Continuously variable transmission models

1. Keeping your right foot on the brake pedal, put the shift lever in **[D]**. Select **[R]** when reversing.
2. With the parking brake is applied, release the brake pedal and gently depress the accelerator pedal.
 - ▶ Make sure the parking brake and brake system indicator (red) goes off.
 - **Parking Brake** P. 629

■ Hill start assist system

Hill start assist keeps the brake engaged briefly to help to prevent the vehicle from rolling on inclines as you move your foot from the brake pedal to the accelerator.

Continuously variable transmission models

Move the shift lever to **[D]** or **[S]** when facing uphill, or **[R]** when facing downhill, then release the brake pedal.

Manual transmission models

Depress the clutch pedal, and shift to one of the forward gears when facing uphill, or **[R]** when facing downhill, then release the brake pedal.

▶▶ Starting to Drive

Manual transmission models

If the engine stalls, fully depress the clutch pedal within three seconds. The engine may automatically restart under certain conditions. Otherwise, follow the standard procedure.

➤ **Starting the Engine** P. 517

You can also release the parking brake by pressing the electric parking brake switch while depressing the brake pedal. When facing downhill, you can start your vehicle more smoothly by manually releasing it with the electric parking brake switch than by releasing it with the accelerator pedal.

▶▶ Hill start assist system

Hill start assist may not prevent the vehicle from rolling downhill on a very steep or slippery slope, and will not operate on small inclines.

Hill start assist is not a replacement for the parking brake.

Hill start assist will operate even when VSA is switched off.

Precautions While Driving

■ Driving Guidelines for Your Utility Vehicle

Utility vehicles have a significantly higher rollover rate than other types of vehicles. To prevent rollovers or loss of control:

- Take corners at slower speeds than you would with a passenger vehicle.
- Avoid sharp turns and abrupt manoeuvres whenever possible.
- Do not modify your vehicle in any way that you would raise the centre of gravity.
- Do not carry heavy luggage on the roof.

■ In a Fog

Visibility becomes low when it is foggy. When you drive, turn on the low beam headlights even during the daytime. Slow down, using the road line in the centre, guard rails, and the taillights of the vehicle ahead of you as your driving guide.

■ In a Strong Wind

If a strong side wind drifts your vehicle while driving, hold the steering wheel tight. Slowly decelerate your vehicle and keep your vehicle in the middle of the road. Be careful with wind gusts especially when your vehicle is exiting a tunnel, driving on a bridge or river bank, and driving through an open area like a quarry, and when a large lorry is passing by.

▶▶ Precautions While Driving

CAUTION: Do not drive on the road where water is deep. Driving through deep water will cause damage to the engine and electrical equipment and the vehicle will break down.

NOTICE

Do not operate the shift lever while pressing the accelerator pedal. You could damage the transmission.

NOTICE

If you repeatedly turn the steering wheel at an extremely low speed, or hold the steering wheel in the full left or right position for a while, the electric power steering (EPS) system heats up. The system goes into a protective mode, and limits its performance. The steering wheel becomes harder and harder to operate. Once the system cools down, the EPS system is restored. Repeated operation under these conditions can eventually damage the system.

If the ignition switch is turned to ACCESSORY **I***1 while driving, the engine will shut down and all steering and brake power assist functions will stop, making it difficult to control the vehicle.

Do not put the shift lever in **N**, as you will lose engine braking (and acceleration) performance.

*1: Models with the keyless access system have an **ENGINE START/STOP** button instead of an ignition switch.

■ In Rain

The road is slippery when raining. Avoid hard braking, rapid acceleration, and abrupt steering and be more cautious when driving. It is likely to experience hydroplaning phenomenon if you are driving on a rutted road with puddles. Do not drive in deep water and on flooded roads. This can damage the engine or driveline, or cause electrical component failure.

■ Other Precautions

If there is a strong impact with something under the vehicle, stop in a safe location. Check the underside of the vehicle for damage or any fluid leaks.

⊠ Precautions While Driving

During the first 1,000 km (625 miles) of operation, avoid sudden acceleration or full throttle operation so as not to damage the engine or powertrain.

Avoid hard braking for the first 300 km (200 miles). You should also follow this when the brake pads are replaced.

⊠ Driving Guidelines for Your Utility Vehicle

Failure to operate your vehicle correctly might result in a crash or a rollover.

➤ **Important Handling Information** P. 40

➤ **Precautions While Driving** P. 520

⊠ In Rain

Be careful when hydroplaning phenomenon occurs. When you drive on a road covered with water at excessive speed, a layer of water builds between the tyres and the road surface. If this occurs, the vehicle cannot respond to control inputs such as steering, and braking.

Slowly decelerate when you shift down. If the road is slippery, sudden engine braking can cause the tyres to skid.

Continuously Variable Transmission *

■ Creeping

The engine runs at a higher idle speed and creeping increases. Keep the brake pedal firmly depressed when stopped.

■ Kickdown

Quickly depressing the accelerator pedal while driving uphill may cause the transmission to drop to a lower ratio, unexpectedly increasing vehicle speed. Depress the accelerator pedal carefully, especially on slippery roads and curves.

Continuously variable transmission models

Shifting

Change the shift position in accordance with your driving needs.

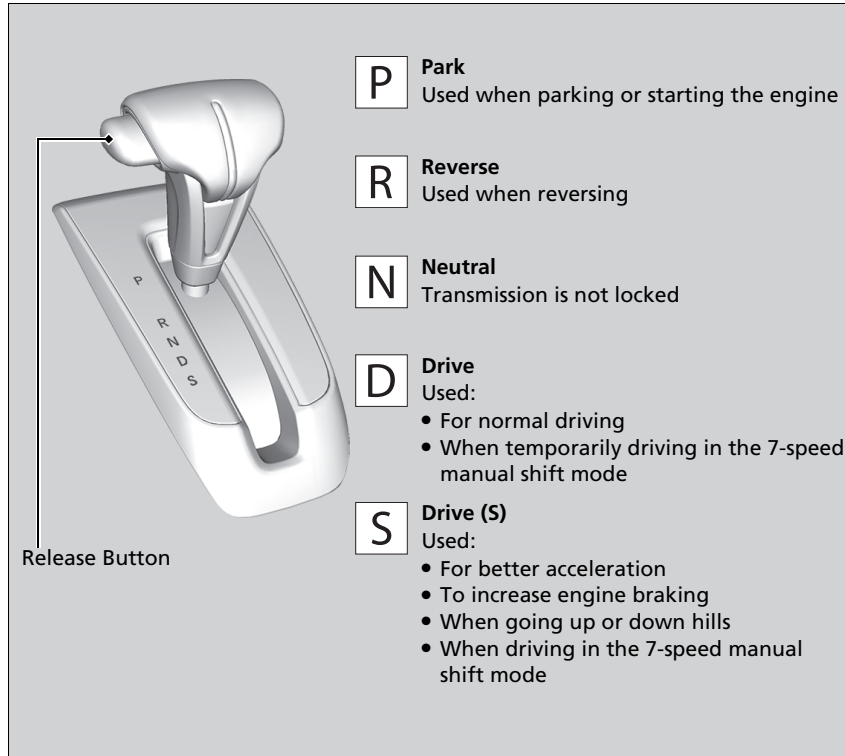
■ Shift lever positions**⌘ Shifting**

You cannot turn the ignition switch to LOCK **[0]***1 and remove the key unless the shift lever is in **[P]**.

The vehicle may move very slightly even in **[N]** while the engine is cold.

Depress the brake pedal firmly and, when necessary, apply the parking brake.

*1: Models with the keyless access system have an **ENGINE START/STOP** button instead of an ignition switch.

Shift Lever Operation

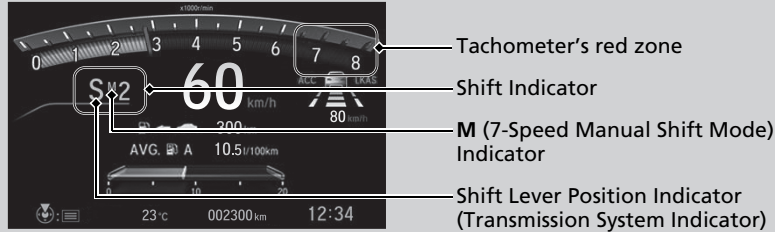

Tachometer's red zone

Shift Indicator

M (7-Speed Manual Shift Mode) Indicator

Shift Lever Position Indicator (Transmission System Indicator)

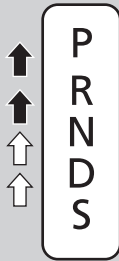

Depress the brake pedal and press the shift lever release button to shift.

Shift without pressing the shift lever release button.

Press the shift lever release button and shift.

Shift Lever Operation

NOTICE

When you change the shift lever from **D** to **R** and vice versa, come to a complete stop and keep the brake pedal depressed.

Operating the shift lever before the vehicle has come to a complete standstill can damage the transmission.

Use the shift lever position indicator to check the lever position before pulling away.

Whichever position the shift lever is in when driving, blinking transmission system indicator indicates a transmission problem.

Avoid sudden acceleration and have the transmission checked by a dealer as soon as possible.

The fuel supply may be cut off if you drive at engine speeds in or over the tachometer's red zone (engine speed limit). If this happens, you may experience a slight jolt.

It may not be possible to operate the shift lever if the brake pedal is applied while the shift lever release button is held down.

Depress the brake pedal first.

■ 7-Speed Manual Shift Mode

Use the paddle shifters to change between 1st and 7th speeds without releasing your hands from the steering wheel. The transmission switches to the 7-speed manual shift mode when you pull a paddle shifter while driving. This mode is useful when engine braking is needed.

■ When the shift lever is in **[D]**:

The shift mode goes into the 7-speed manual shift mode temporarily, and the number is displayed in the shift indicator.

The 7-speed manual shift mode is cancelled automatically if you drive at constant speed, and the number in the shift indicator goes off.

You can cancel this mode by pulling the **[+]** paddle shifter for a few seconds.

The 7-speed manual shift mode is especially useful when reducing the vehicle speed temporarily before making a turn.

■ When the shift lever is in **[S]**:

The shift mode goes into the 7-speed manual shift mode. The **M** indicator and the speed number are displayed in the shift indicator. As the vehicle speed slows down, the transmission automatically shifts down accordingly. When the vehicle comes to a stop, it automatically shifts down into 1st.

You can cancel this mode by pulling the **[+]** paddle shifter for a few seconds.

If the vehicle speed increases and the engine speed reaches near the tachometer's red zone, the transmission automatically shifts up.

You can only pull away in 1st speed.

When cancelling the 7-speed manual shift mode, move the shift lever from **[S]** to **[D]**. When the 7-speed manual shift mode is cancelled, the **M** indicator and shift indicator will turn off.

⊠ 7-Speed Manual Shift Mode

To improve fuel economy, the transmission may shift up to a higher speed than the seventh under certain circumstances. In this case, the number in the shift indicator remains as **7**.

In the 7-speed manual shift mode, the transmission shifts up or down by operating either paddle shifter under the following conditions:

Shift Up: The engine speed reaches the lowest threshold of the higher speed position.

Shift Down: The engine speed reaches the highest threshold of the lower speed position.

When the engine speed reaches near the tachometer's red zone, the transmission shifts up automatically.

When the engine speed reaches the lowest threshold of the selected speed position, the transmission shifts down automatically.

Operating the paddle shifters on slippery surfaces may cause the tyres to lock up. In this case, the 7-speed manual shift mode is cancelled and goes back to the normal **[D]** driving mode.

7-Speed Manual Shift Mode Operation

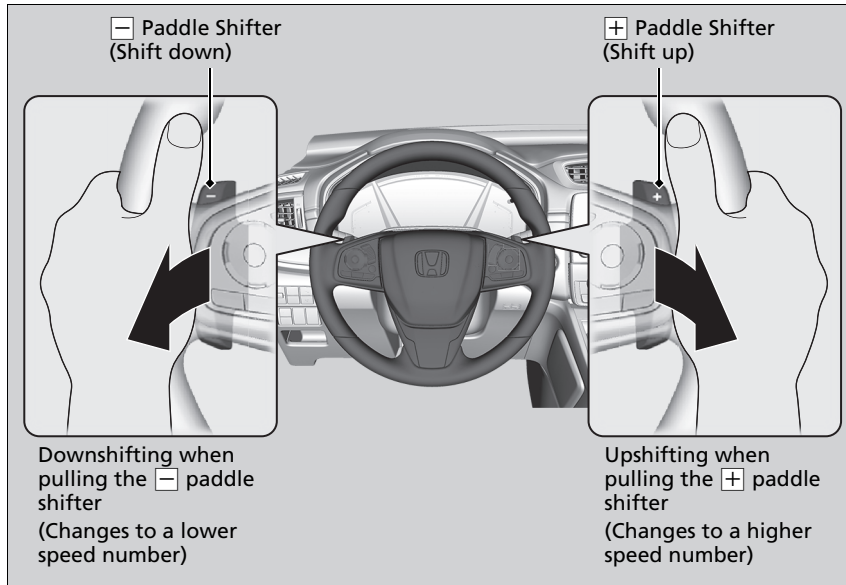

7-Speed Manual Shift Mode Operation

Each paddle shift operation makes a single speed change.
To change continuously, release the paddle shifter before pulling it again for the next speed.

The shift indicator blinks when you cannot shift up or down. It indicates that your vehicle speed is not in its allowable shifting range.
Slightly accelerate to shift up and decelerate to shift down while the indicator is blinking.

Shift Up Indicator

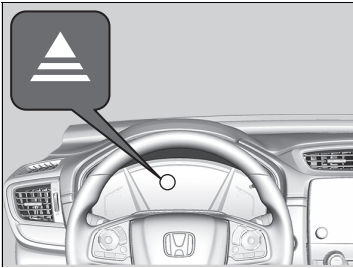

Comes on while the vehicle is in the 7-speed manual shift mode to indicate when shifting is appropriate to maintain the most fuel efficient driving style.

The shift up indicator: Comes on when upshifting is recommended.

Shift Up Indicator

⚠ WARNING

The shift indicator is only a guide to help you achieve better fuel economy. Never refer to the Shift Indicators when road and traffic conditions are unsuitable or when it may distract you.

This indicator will not prompt you to downshift to increase engine braking. It is up to you to downshift to increase engine braking when driving downhill.

Always shift down at the appropriate vehicle speed.

Ambient meter colour may change if you do not shift up or down when a shift indicator illuminates. This can result in a change in fuel economy.

Road and traffic conditions may require you to shift at times other than those indicated.

Manual transmission models

Shifting

Shift Lever Operation

Fully depress the clutch pedal to operate the shift lever and change gears, then slowly release the pedal.

Depress the clutch pedal, and pause for a few seconds before shifting into **[R]**, or shift into one of the forward gears for a moment. This stops the gears so they do not “grind.”



When you are not shifting, do not rest your foot on the clutch pedal. This can cause your clutch to wear out faster.

Shifting

NOTICE

Do not shift to **[R]** before the vehicle comes to a complete stop. Shifting to **[R]** before stopping can damage the transmission.

NOTICE

Before downshifting, make sure the engine will not go into the tachometer’s red zone. Should this occur, it can severely damage your engine.

There is a metallic part on the shift lever. If you leave the vehicle parked outside for a long time on a hot day, be careful before moving the shift lever. Because of heat, the shift lever may be extremely hot. If the outside temperature is low, the shift lever may feel cold.

If you exceed the maximum speed for the gear you are in, the engine speed will enter into the tachometer’s red zone. When this happens, you may experience a slight jolt.

Shift Up/Down Indicators

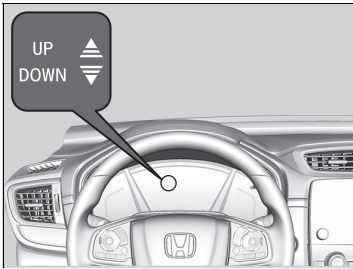

Come on to notify you that a gear change is recommended in order to maintain fuel efficient driving or to prevent the engine from stalling.

The shift up indicator: Comes on when upshifting is recommended.

The shift down indicator: Comes on when downshifting is recommended.

Shift Up/Down Indicators

WARNING

The shift indicator is a guide to help you achieve better fuel economy. Never refer to the Shift Indicators when road and traffic conditions are unsuitable or when it may distract you.

This indicator will not prompt you to downshift to increase engine braking. It is up to you to downshift to increase engine braking when driving downhill.

Always shift down at the appropriate vehicle speed.

The shift down indicator does not come on when downshifting from **2** to **1**.

Ambient meter colour may change if you do not change gears when a shift indicator illuminates. This can result in a change in fuel economy.

Road and traffic conditions may require you to shift at times other than those indicated.

Reverse Lockout

The manual transmission has a lockout mechanism that stops you from accidentally shifting into **R** from a forward gear while the vehicle is moving at a certain speed.

If you cannot shift to **R** when the vehicle is stopped, do the following:

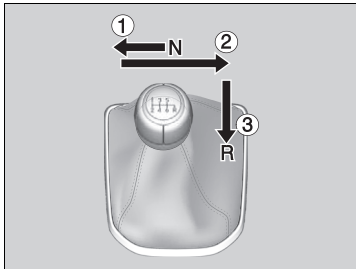

1. Depress the clutch pedal, move the shift lever all the way to the left, and shift to **R**.
2. If you still cannot shift into **R**, apply the parking brake, and turn the ignition switch to ACCESSORY **I** or LOCK **O***1.
3. Depress the clutch pedal and shift into **R**.
4. Keep depressing the clutch pedal and start the engine.

Have the vehicle checked by a dealer if you have to go through this procedure repeatedly.

*1: Models with the keyless access system have an **ENGINE START/STOP** button instead of an ignition switch.

ECON Mode

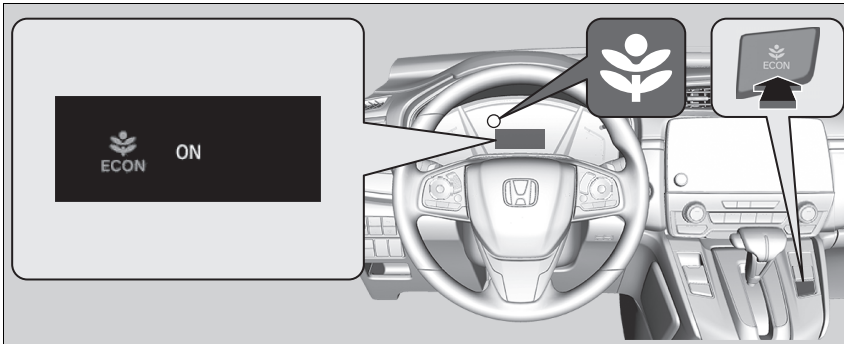

The **ECON** button turns the ECON mode on and off.
The ECON mode helps you to improve your fuel economy by adjusting the performance of the engine, transmission, and climate control system.

▶▶ ECON Mode

While in ECON mode, the climate control system has greater temperature fluctuations.

Manual transmission models

Auto Idle Stop

To help maximise fuel economy, the engine automatically stops when the vehicle comes to a stop, depending on environmental and vehicle operating conditions. The indicator (green) comes on at this time. The engine then restarts once the vehicle is about to move again, depending on environmental and vehicle conditions, and the indicator (green) goes off.

➤ **The Engine Automatically Restarts When:** P. 535

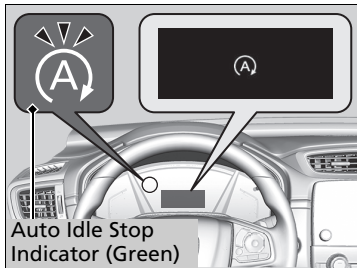

If the driver's door is opened while the indicator (green) is on, a buzzer sounds to notify you that Auto Idle Stop function is in operation.

A message associated with Auto Idle Stop appears on the driver information interface.

➤ **Indicators** P. 98

➤ **Customized Features** P. 158, 413

Auto Idle Stop

The 12-volt battery installed in this vehicle is specifically designed for a model with Auto Idle Stop. Using a 12-volt battery other than this specified type may shorten the 12-volt battery life, and prevent Auto Idle Stop from activating. If you need to replace the 12-volt battery, make sure to select the specified type. Ask a dealer for more details.

➤ **Specifications** P. 770

The duration of the Auto Idle Stop operation:

- **Increases** in the ECON mode, compared to when the ECON mode is off, with climate control in use.

■ Auto Idle Stop System ON/OFF

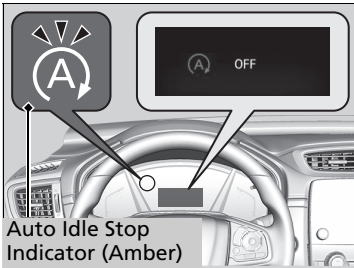

Auto Idle Stop
Indicator (Amber)

To turn the Auto Idle Stop system off, press this button. The Auto Idle Stop system stops.

- ▶ Auto Idle Stop system will stop and the indicator (amber) will come on.

The Auto Idle Stop system is turned on every time you start the engine, even if you turned it off the last time you drove the vehicle.

☒ Auto Idle Stop System ON/OFF

Pressing the Auto Idle Stop **OFF** button restarts the engine during the Auto Idle Stop activated.

■ Auto Idle Stop Activates When:

After the vehicle moves forward, stopping with the brake, the clutch pedal fully depressed, the shift lever in **[N]**, and then the clutch pedal is released.

▶ To restart the engine automatically, depress the clutch pedal.

■ Auto Idle Stop does not activate when:

- The Auto Idle Stop **OFF** button is pressed.
- The driver's seat belt is not fastened.
- The engine coolant temperature is low or high.
- The vehicle comes to a stop again before the vehicle speed reaches 3 km/h (2 mph) after the engine starts.
- The shift lever is in any position except **[N]**.
- The engine is started with the bonnet open.
 - ▶ Turn off the engine. Close the bonnet before you restart the engine to activate Auto Idle Stop.
- The battery charge is low.
- The internal temperature of the battery is 5°C or less.
- The climate control system is in use, and the outside temperature is below -20°C or over 40°C.
- The climate control system is in use, and the temperature is set to **Hi** or **Lo**.
-  is on (the indicator on).

■ Auto Idle Stop may not activate when:

- The steering wheel is operated.
- The fan speed is high.
- The climate control system is in use, and there is a significant difference between the set temperature and the actual interior temperature.
- The climate control system is in use, and humidity in the interior is high.

▶▶ Auto Idle Stop Activates When:

Do not open a bonnet during idling stop. If the bonnet is opened, the engine will not restart automatically.

In this case, restart the engine with the ignition switch or the **ENGINE START/STOP** button.

▶ **Starting the Engine** P. 514, 517

Models with keyless access system

Pressing the **ENGINE START/STOP** button changes the power mode to **ACCESSORY** even while Auto Idle Stop is in operation. Once in **ACCESSORY**, the engine no longer restarts automatically. Follow the standard procedure to start the engine.

▶ **Starting the Engine** P. 517

Models without keyless access system

Even if you turn the ignition switch to **START** **[III]** during the Auto Idle Stop activated, the engine does not start.

■ The Engine Automatically Restarts When:

- The clutch pedal is depressed.

■ The engine automatically restarts even if the clutch pedal is not depressed with the transmission in **N** when:

- The Auto Idle Stop **OFF** button is pressed.
- The steering wheel is operated.
- Your vehicle is moved.
- The brake pedal is released slightly during a stop.
- The battery charge becomes low.

■ When Indicator Light (Green) Blinks in Auto Idle Stop

Fully depress the clutch pedal.

- ▶ The engine automatically restarts.

⊠ The Engine Automatically Restarts When:

If you are using an electronic device during Auto Idle Stop, the device may temporarily be turned off when the engine restarts.

The engine does not restart automatically when there is a problem in the system. Follow the normal procedure to start the engine.

▶ **Starting the Engine** P. 514, 517

During Auto Idle Stop, the engine does not restart automatically if:

- The driver's seat belt is unlatched. To keep Auto Idle Stop activated, fasten your seat belt immediately.
- The transmission is put into a position other than **N**. Put the transmission into **N**.

▶ **Driver Information Interface Warning and Information Messages** P. 122

When the system stops operating, follow the normal procedure to start the engine.

▶ **Starting the Engine** P. 514, 517

⊠ When Indicator Light (Green) Blinks in Auto Idle Stop

The indicator starts blinking rapidly under the following conditions:

-  is touched.
- When the climate control system is in use and moisture builds up inside the vehicle.
- When the climate control system is in use and the difference between the set temperature and the actual temperature inside the vehicle becomes significant.

Adjustable Speed Limiter

This system enables you to set a maximum speed that cannot be exceeded even if you are depressing the accelerator pedal.

The vehicle speed limit can be set from about 30 km/h (18 mph) to about 250 km/h (156 mph).

Adjustable Speed Limiter

WARNING

Adjustable Speed Limiter has limitations. It is always your responsibility to adjust the vehicle speed to obey the actual speed limit, and safely operate the vehicle.

WARNING

Do not depress the accelerator pedal more than necessary. Maintain an appropriate accelerator pedal position depending on the vehicle speed.

The adjustable speed limiter may not hold the set speed limit when driving downhill. If this occurs, slow down by depressing the brake pedal.

When not using the adjustable speed limiter: Turn off the adjustable speed limiter by pressing the **MAIN** button.

You cannot use the adjustable speed limiter and the adaptive cruise control (ACC)*/adaptive cruise control (ACC) with LSF* or intelligent speed limiter at the same time.

Manual transmission models

When the engine speed slows down, try to downshift.

How to use

- Press the **MAIN** button on the steering wheel

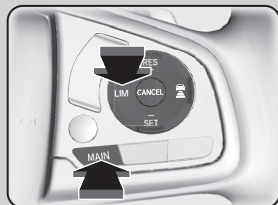

If a different indicator comes on, press the **LIM** button to switch to the adjustable speed limiter.

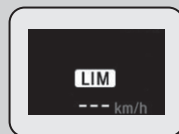

The indicator is on in the instrument panel. Adjustable speed limiter is ready to use.

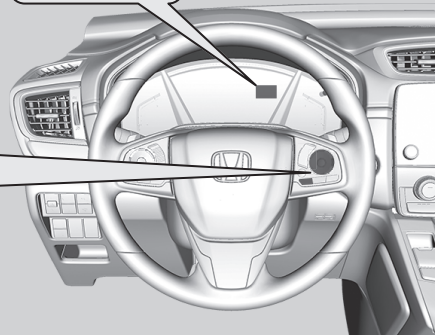

■ To Set the Speed Limit

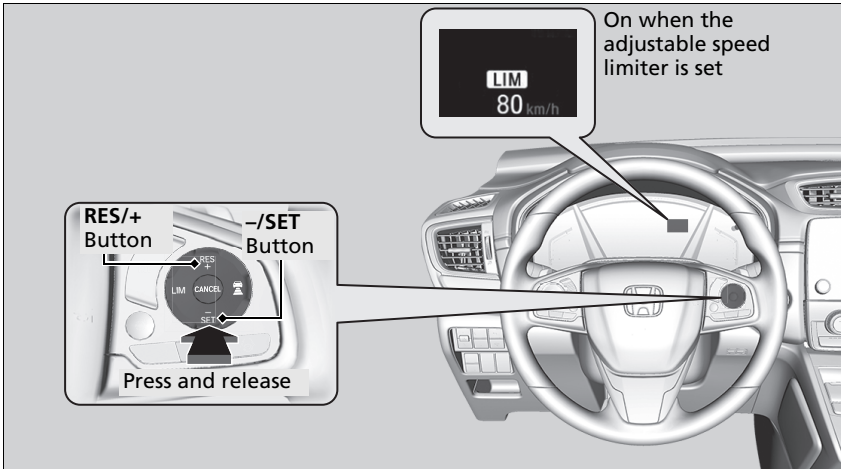

- Take your foot off the accelerator pedal and press the **-/SET** button when you reach the desired speed.
The moment you release the **-/SET** button, the speed limit is fixed, and the adjustable speed limiter is set. The speed limit is displayed.
- You can set the previously set speed limit by pressing the **RES/+** button.

☒ To Set the Speed Limit

If you set the speed limit while travelling at less than 30 km/h (18 mph), the speed limit is set to 30 km/h (18 mph).

The beeper sounds and the displayed speed limit blinks if the vehicle speed exceeds the limit by 3 km/h (2 mph) or more on a steep descent.

The adjustable speed limiter is set to the current speed if it is higher than the previously set speed limit when you press the **RES/+** button.

You can switch the displayed set speed measurements between km/h and mph on the driver information interface.

☒ **Speedometer** P. 147

☒ **Customized Features** P. 158, 413

■ To Adjust the Speed Limit

Increase or decrease the speed limit by using the **RES/+** or **-/SET** buttons on the steering wheel.

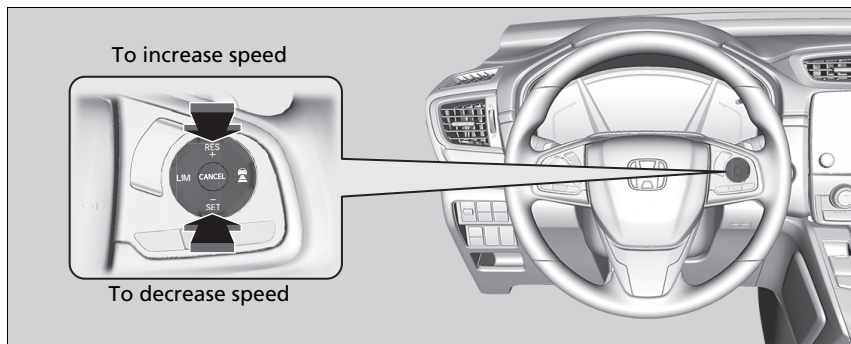

- Each time you press the button, the speed limit increases or decreases by 1 km/h or 1 mph accordingly.
- If you keep the button pressed, the speed limit increases or decreases in increments of 10 km/h or 10 mph every 0.5 second until system limit is reached.
- The vehicle may accelerate or decelerate until the set speed is reached.

■ Exceeding the Speed Limit Temporarily

The speed limit can be exceeded by depressing the accelerator pedal completely.

- ▶ The displayed limit speed blinks.
- ▶ The beeper sounds once the speed limit has been exceeded.

⊠ Exceeding the Speed Limit Temporarily

The beeper sounds when the vehicle speed goes higher than the set speed limit with the accelerator pedal depressed completely.

The adjustable speed limiter resumes working once the vehicle speed goes lower than the set speed limit.

To Cancel

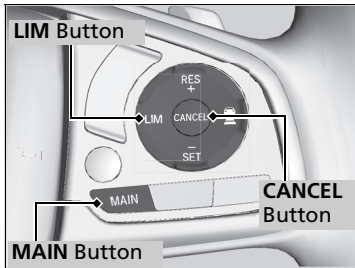

To cancel the adjustable speed limiter, do any of the following:

- Press the **CANCEL** button.
- Press the **MAIN** button.
- Press the **LIM** button.

To Cancel

The adjustable speed limiter changes into adaptive cruise control (ACC)*/adaptive cruise control (ACC) with LSF* or intelligent speed limiter if the **LIM** button is pressed.

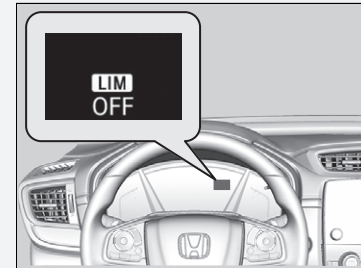

If there is a problem with the system when you are using the adjustable speed limiter, the beeper sounds and **OFF** comes on. The adjustable speed limiter will be turned off.

* Not available on all models

Intelligent Speed Limiter

Automatically sets the speed limit that the traffic sign recognition system detects. And the speed limit cannot be exceeded even if you are depressing the accelerator pedal. If you fully depress the accelerator the speed limit can be exceeded.

➤ **Traffic Sign Recognition System** P. 618

Intelligent Speed Limiter

WARNING

Intelligent Speed Limiter has limitations. The Intelligent Speed Limiter may set itself to a speed above or below the actual speed limit, or may not work, particularly where the traffic sign recognition system does not operate correctly or where a road has no speed limit signs. It is always your responsibility to adjust the speed to obey the actual speed limit and to safely operate the vehicle.

Depending on the amount of depression of the accelerator pedal, the vehicle will accelerate until it reaches the speed identified by the traffic sign recognition system.

How to use

■ Press the **MAIN** button on the steering wheel

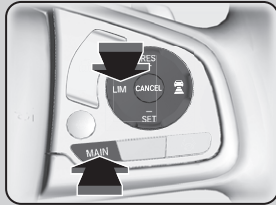

If a different indicator comes on, press the **LIM** button to change it to the intelligent speed limiter.



The indicator is on in the instrument panel
Intelligent speed limiter is ready to use.

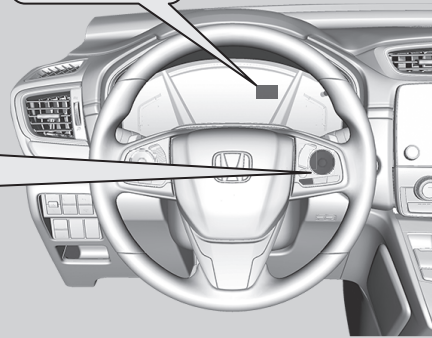

▶ Intelligent Speed Limiter

The system is designed to detect signs that follow the Vienna Convention standards. Not all signs may be detected, but any signs posted on roadsides should not be ignored. The system does not work on the designated traffic signs of all the countries you travel, nor in all situations.

▶ **Traffic Sign Recognition System** P. 618

If the intelligent speed limiter is set to the wrong speed limit, try one of the following:

To cancel

- Press the **CANCEL** button.
- Press the **MAIN** button.
- Press the **LIM** button.

To exceed the speed limit temporarily

- Depress the accelerator pedal fully.

The intelligent speed limiter may not hold the set speed limit when driving downhill. If this occurs, slow down by depressing the brake pedal.

When not using the intelligent speed limiter, turn off the intelligent speed limiter by pressing the **MAIN** button.

You cannot use the intelligent speed limiter and adaptive cruise control (ACC)*/adaptive cruise control (ACC) with LSF* or adjustable speed limiter at the same time.

* Not available on all models

■ To Set the Speed Limit

On when the intelligent speed limiter is set to the speed limit that the traffic sign recognition system detects.

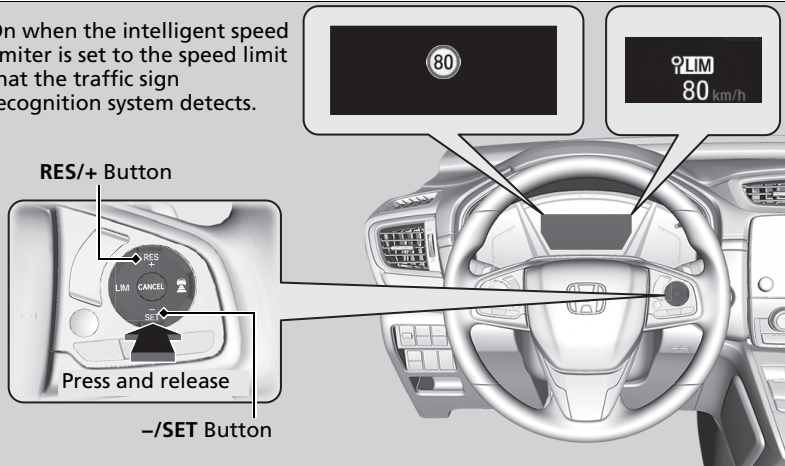

- The moment you release the **-/SET** button or **RES/+** button, the intelligent speed limiter is set to the speed limit that the traffic sign recognition system detects. The speed limit is displayed.

▶ Intelligent Speed Limiter

Manual transmission models

When the engine speed slows down, try to downshift.

Do not use the intelligent speed limiter in areas of different units from the display unit of the intelligent speed limiter.

Change the displayed measurement of the set vehicle speed to the same units as the driving areas.

▶ **Speedometer** P. 147

▶ **Customized Features** P. 158, 413

▶ To Set the Speed Limit

If you set the intelligent speed limiter when the speed limit that the traffic sign recognition system detects is less than 30 km/h (20 mph), the speed limitation function and warning function may switch to pause.

If your vehicle speed is higher than the speed limit that the traffic sign recognition system detects, your vehicle decelerates slowly to the speed limit or less. If necessary, slow down by depressing the brake pedal. And the beeper sounds and the displayed speed limit blinks if the vehicle speed exceeds the limit by 3 km/h (2 mph) or more.

■ **When the traffic sign recognition system detects the new speed limit sign**

The intelligent speed limiter is set to the new speed limit that the traffic sign recognition system detects.

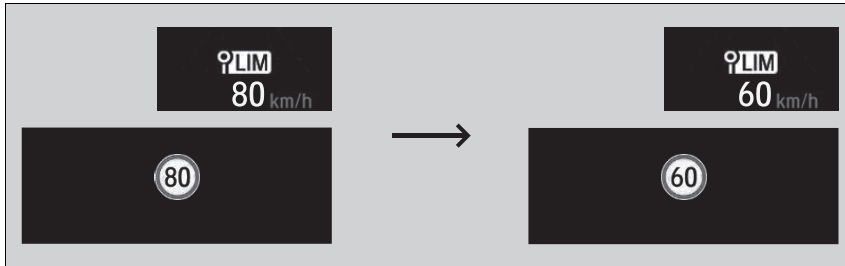

■ **The speed limitation function and warning function may switch to pause if there is no speed limit sign in the screen of the traffic sign recognition system when:**

- The end of speed limit or other designated limit is detected.
- Your vehicle enters/exits motorway or highway.
- You make a turn with a turn signal at an intersection.

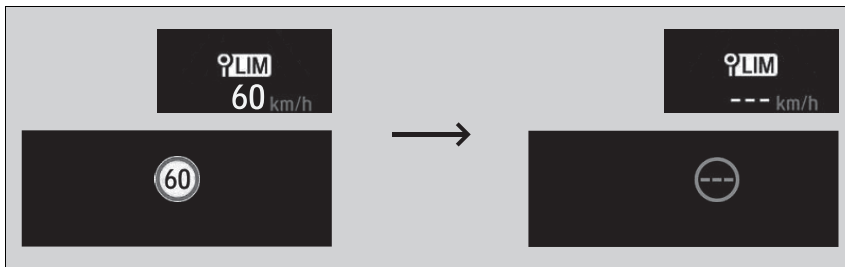

▶▶ To Set the Speed Limit

The intelligent speed limiter may also switch to pause when the traffic sign recognition system detects only additional speed limit signs.

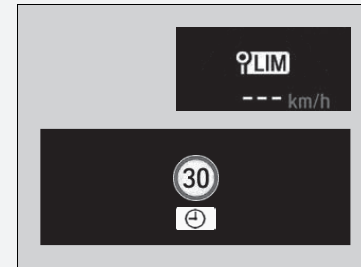

■ **When the traffic sign recognition system detects the speed limit sign while the intelligent speed limiter is paused**

The speed limitation function and warning function will be resumed automatically.

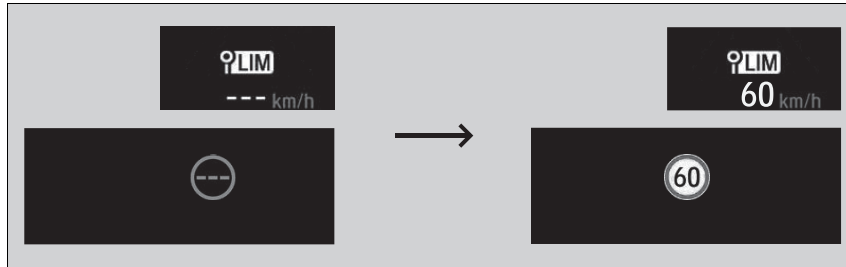

■ **When the traffic sign recognition system does not detect the speed limit sign for a time while the intelligent speed limiter is activated**

While driving, in addition to when the traffic sign recognition system detects no speed limit sign, the traffic sign recognition system may display no speed limit. But, intelligent speed limiter functions continue.

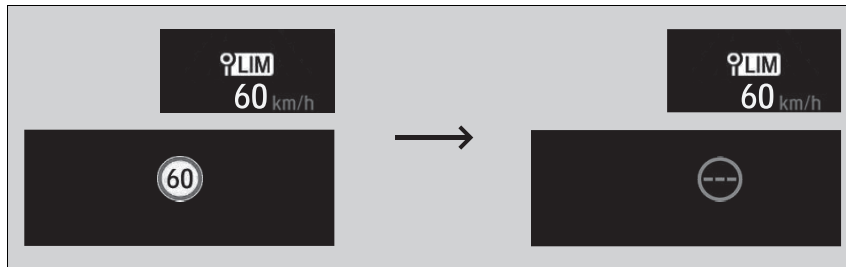

■ To Adjust the Speed Limit

Increase or decrease the speed limit by using the **RES/+** or **-/SET** buttons on the steering wheel.

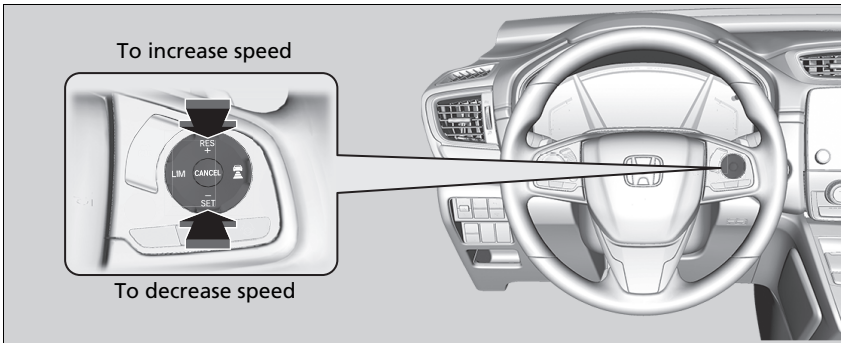

- Each time you press the button, the speed limit is increased or decreased by about 1 km/h or 1 mph accordingly.
- You can increase the speed limit up to +10 km/h or +5 mph on the basis of the speed limit that the traffic sign recognition system detects.
- You can decrease the speed limit up to -10 km/h or -5 mph on the basis of the speed limit that the traffic sign recognition system detects.
- You can accelerate until the set speed is reached. If your vehicle speed is higher than the speed limit that the traffic sign recognition system detects, your vehicle decelerates slowly to the speed limit.

■ Exceeding the Speed Limit Temporarily

The speed limit can be exceeded by depressing the accelerator pedal fully.

- ▶ The displayed speed limit blinks.
The beeper sounds once the speed limit has been exceeded.

Continued

☒ To Adjust the Speed Limit

A negative or positive offset with respect to the speed limit will be reset automatically when the traffic sign recognition system detects a new speed limit sign.

You cannot decrease the speed limit to less than 30 km/h (18 mph).

☒ Exceeding the Speed Limit Temporarily

The beeper sounds when the vehicle speed goes higher than the set speed limit with the accelerator pedal depressed completely.

The intelligent speed limiter resumes working once the vehicle speed goes lower than the set speed limit.

■ To Cancel

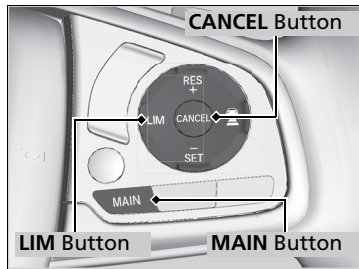

To cancel the intelligent speed limiter, do any of the following:

- Press the **CANCEL** button.
- Press the **MAIN** button.
- Press the **LIM** button.

☞ To Cancel

The intelligent speed limiter changes into adaptive cruise control (ACC)*/adaptive cruise control (ACC) with LSF* or adjustable speed limiter if the **LIM** button is pressed.



If there is a problem with the system or traffic sign recognition system when you are using the intelligent speed limiter, the beeper sounds and **OFF** comes on. The intelligent speed limiter will be turned off.

☞ **Traffic Sign Recognition System** P. 618

Vehicle Stability Assist (VSA) System

VSA helps to stabilise the vehicle during cornering if the vehicle turns more or less than what was intended. It also assists in maintaining traction on slippery surfaces. It does so by regulating engine output and selectively applying the brakes.

VSA Operation

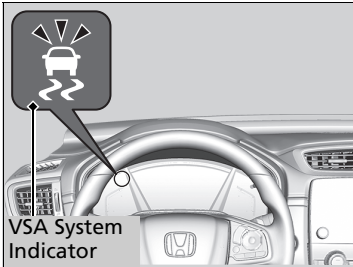

When VSA activates, you may notice that the engine does not respond to the accelerator. You may also notice some noise from the hydraulic system. You will also see the indicator blink.

* 1: Models with the keyless access system have an **ENGINE START/STOP** button instead of an ignition switch.

* Not available on all models

Vehicle Stability Assist (VSA) System

The VSA may not function properly if tyre type and size are mixed. Make sure to use the same size and type of tyre, and the air pressures as specified.

When the VSA system indicator comes on and stays on while driving, there may be a problem with the system. While this may not interfere with normal driving, have your vehicle checked by a dealer immediately.

VSA cannot enhance stability in all driving situations and does not control the entire braking system. You still need to drive and corner at speeds appropriate for the conditions and always leave a sufficient margin of safety.

The main function of the VSA system is generally known as Electronic Stability Control (ESC). The system also includes a traction control function.

The adaptive cruise control (ACC)*, adaptive cruise control (ACC) with low speed follow (LSF)*, road departure mitigation, vehicle stability assist (VSA) system, vehicle stability assist (VSA) OFF, low tyre pressure/deflation warning system, collision mitigation braking system (CMBS), and parking brake and brake system (amber) indicators may come on in amber along with a message in the driver information interface when you turn the ignition switch to ON **II***¹ after reconnecting the battery. Drive a short distance at more than 20 km/h (12mph). Each indicator should go off. If any do not, have your vehicle checked by a dealer.

Continued

VSA On and Off

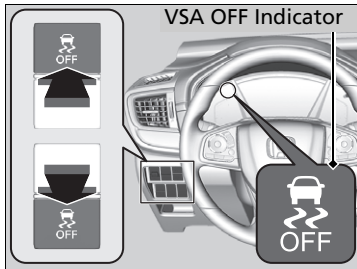

This button is on the driver side control panel. To partially disable VSA functionality/features, press and hold it until you hear a beep.

Your vehicle will have normal braking and cornering ability, but traction control function will be less effective.

To restore VSA functionality/features, press the  button until you hear a beep.

VSA is turned on every time you start the engine, even if you turned it off the last time you drove the vehicle.

Vehicle Stability Assist (VSA) System

In certain unusual conditions when your vehicle gets stuck in shallow mud or fresh snow, it may be easier to free it with the VSA temporarily switched off.

When the  button is pressed, the traction control function becomes less effective. This allows for the wheels to spin more freely at low speed. You should only attempt to free your vehicle with the VSA off if you are not able to free it when the VSA is on.

Immediately after freeing your vehicle, be sure to switch VSA on again. We do not recommend driving your vehicle with the VSA system switched off.

You may hear a motor sound coming from the engine compartment while system checks are being performed immediately after starting the engine or while driving. This is normal.

Agile Handling Assist

Lightly brakes each of the front and rear wheels, as needed, when you turn the steering wheel, and helps to support the vehicle's stability and performance during cornering.

ⓘ Agile Handling Assist

The agile handling assist cannot enhance stability in all driving situations. You still need to drive and corner at speeds appropriate for the conditions and always leave a sufficient margin of safety.

When the VSA system indicator comes on and stays on while driving, the agile handling assist does not activate.

You may hear a sound coming from the engine compartment while the agile handling assist is activated. This is normal.

Real Time AWD with Intelligent Control System*

Your vehicle is equipped with the AWD system. When the system senses a loss of front wheel traction, it automatically transfers some power to the rear wheels. This allows you to utilise all available traction and may increase mobility.

You still need to exercise the same care when accelerating, steering, and braking that you would in a two wheel drive vehicle.

If you excessively spin all four wheels and overheat the AWD system, only the front wheels receive power. Stop until the system cools down.

ⓘ Real Time AWD with Intelligent Control System*

NOTICE

Do not continuously spin the front tyres of your vehicle. Continuously spinning the front tyres can cause transmission or rear differential damage.

The AWD system may not function properly if tyre type and size are mixed. Make sure to use the same size and type of tyre, and the air pressures as specified.

🔧 **Tyre and Wheel Replacement** P. 709

Deflation Warning System

Instead of directly measuring the pressure in each tyre, the deflation warning system on this vehicle monitors and compares the rolling radius and rotational characteristics of each wheel and tyre while you are driving to determine if one or more tyres are significantly under-inflated. This will cause the low tyre pressure/deflation warning system indicator to come on and a message to appear on the driver information interface.

Deflation Warning System Initialisation

You must start deflation warning system initialisation every time you:

- Adjust the pressure in one or more tyres.
- Rotate the tyres.
- Replace one or more tyres.

Before initialising the deflation warning system:

- Set the cold tyre pressure in all four tyres.

➔ **Checking Tyres** P. 707

Make sure:

- The vehicle is at a complete stop.

Continuously variable transmission models

- The transmission is in **P**.

Manual transmission models

- The shift lever is in **N**.

All models

- The ignition switch is in ON **II***1.

*1: Models with the keyless access system have an **ENGINE START/STOP** button instead of an ignition switch.

* Not available on all models

Deflation Warning System

The system does not monitor the tyres when driving at low speed.

Conditions such as low ambient temperature and altitude change directly affect tyre pressure and can trigger the low tyre pressure/deflation warning system indicator to come on.

Tyre pressure checked and inflated in:

- Warm weather can become under-inflated in colder weather.
- Cold weather can become over-inflated in warmer weather.

The low tyre pressure/deflation warning system indicator will not come on as a result of over inflation.

The deflation warning system may not function properly if tyre type and size are mixed.

Make sure to use the same size and type of tyre.

➔ **Checking and Maintaining Tyres** P. 707

The adaptive cruise control (ACC)*, adaptive cruise control (ACC) with low speed follow (LSF)*, road departure mitigation, vehicle stability assist (VSA) system, vehicle stability assist (VSA) OFF, low tyre pressure/deflation warning system, collision mitigation braking system (CMBS), and parking brake and brake system (amber) indicators may come on in amber along with a message in the driver information interface when you turn the ignition switch to ON **II***1 after reconnecting the battery. Drive a short distance at more than 20 km/h (12 mph). Each indicator should go off. If any do not, have your vehicle checked by a dealer.

Continued

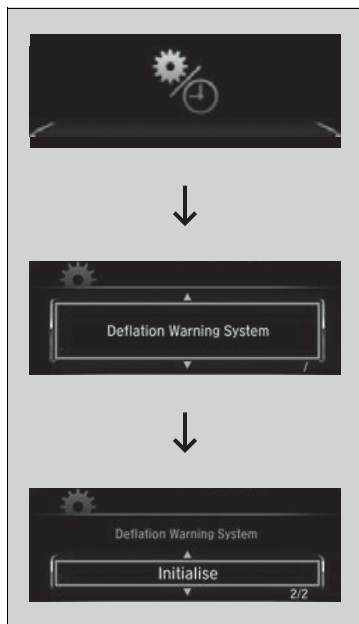

Models with colour audio system

You can initialise the system from the customized features on the driver information interface.

1. Press the then button to select (Customize Settings), then press the **ENTER** button.

▶ **Deflation Warning System** appears on the display.

2. Press the **ENTER** button.

▶ The display switches to the customization setup screen, where you can select **Cancel** or **Initialise**.

3. Press the button and select **Initialise**, then press the **ENTER** button.

▶ **Completed** screen appears, then the display returns to the customization menu screen.

- If the **Failed** message appears, repeat steps 2-3.
- The initialisation process finishes automatically.

▶▶ Deflation Warning System

The low tyre pressure/deflation warning system indicator may come on with a delay or may not come on at all when:

- You rapidly accelerate, decelerate, or turn the steering wheel.
- You drive on snowy or slippery roads.
- Tyre chains are used.

The low tyre pressure/deflation warning system indicator may come on under the following conditions:

- A compact spare tyre is used.
- There is a heavier and uneven load on the tyres, such as when towing a trailer, than the condition at initialisation.
- Tyre chains are used.

▶▶ Deflation Warning System Initialisation

- Deflation Warning System cannot be initialised if a compact spare tyre is installed.
- The initialisation process requires approximately 30 minutes of cumulative driving at speeds between 40-100 km/h (25-62mph).
- During this period, if the ignition is turned on and the vehicle is not moved within 45 seconds, you may notice the low tyre pressure indicator comes on briefly. This is normal and indicates that the initialisation process is not yet complete.

If the tyre chains are installed, remove them before initialising the deflation warning system.

If the low tyre pressure/deflation warning system indicator comes on even when the properly inflated specified regular tyres are installed, have the vehicle checked by a dealer.

We recommend that the tyres be replaced with the same brand, model, and size as the originals. Ask a dealer for details.

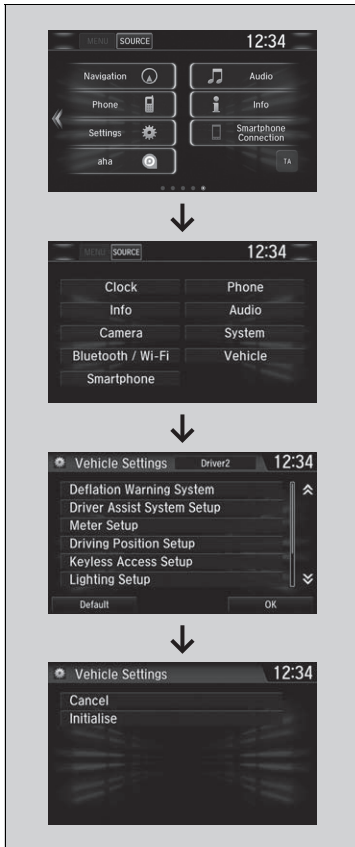

Models with Display Audio

You can initialise the system from the customized feature on the audio/information screen.

1. Set the power mode to ON.
2. Select .
3. Select **Settings**.
4. Select **Vehicle**.
5. Select **Deflation Warning System**.
6. Select **Cancel** or **Initialise**.

- If the **Failed** message appears, repeat steps 4-5.
- The initialisation process finishes automatically.

Adjusting Headlight Distribution

Driving the right-hand type vehicle in right-hand traffic, or the left-hand type vehicle in left-hand traffic causes headlight glare to oncoming vehicles. You need to alter the headlight beam distribution using masking tape.

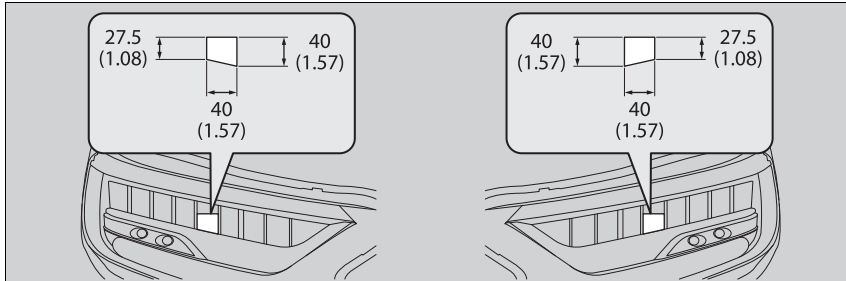

1. Prepare for two pieces of masking tape, measuring 40 mm (1.57 inches) wide and 40 mm (1.57 inches) long.
 - ▶ Use masking tape that can shut out light, such as seal type waterproof vinyl.
2. Affix the tape to the outer portion of the lens as shown.

Adjusting Headlight Distribution

Be careful not to adhere the tape to an incorrect location. If the headlight beam is distributed incorrectly, it may not comply with your country's legal requirements. Ask your dealer for details.

Blind spot information System*

Is designed to detect vehicles in specified alert zones adjacent to your vehicle, particularly in harder to see areas commonly known as “blind spots.” When the system detects vehicles approaching from behind in adjacent lanes, the appropriate indicator comes on for a few seconds, providing assistance when you change lanes.

Blind spot information System*

⚠ WARNING

Failure to visually confirm that it is safe to change lanes before doing so may result in a crash and serious injury or death.



Do not rely only on the blind spot information system when changing lanes.

Always look in your mirrors, to either side of your vehicle, and behind you for other vehicles before changing lanes.

Important Safety Reminder

Like all assistance systems, blind spot information system has limitations. Over reliance on the blind spot information system may result in a collision.

The system is for your convenience only. Even if an object is within the alert zone, the following situations may occur.

- The blind spot information system alert indicator may not come on due to obstruction (splashes, etc.) and the  message appears on the driver information interface.
- The blind spot information system alert indicator may come on even with the  message on the driver information interface.

■ How the system works

- Radar sensors detect a vehicle in the alert zone when your vehicle is moving forward at 20 km/h (12 mph) or faster.

Alert zone range

- A: Approx. 0.5 m (1.6 ft.)
- B: Approx. 3 m (10 ft.)
- C: Approx. 3 m (10 ft.)

Radar Sensors:
underneath the
rear bumper
corners

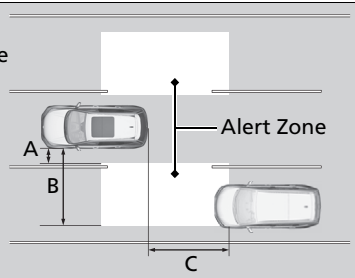

▶▶ Blind spot information System*

You can change the setting for the blind spot information system.

▶ **Customized Features** P. 413

Turn the system off when towing a trailer. The system may not work properly for the following reasons:

- The added mass tilts the vehicle and changes the radar coverage.
- The trailer itself can be detected by the radar sensors, causing the blind spot information system alert indicators to come on.

The blind spot information system alert indicator may not come on under the following conditions:

- A vehicle does not stay in the alert zone for more than two seconds.
- A vehicle is parked in a side lane.
- The speed difference between your vehicle and the vehicle you are passing is greater than 10 km/h (6 mph).
- An object not detected by the radar sensors approaches or passes your vehicle.
- A vehicle running in the adjacent lane is a motorcycle or other small vehicle.

Continuously variable transmission models

The system does not operate when in **R**.

■ When the system detects a vehicle

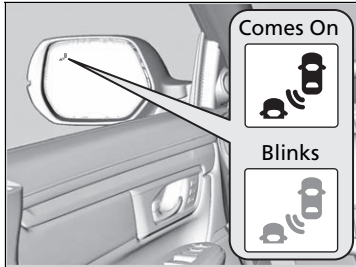

Blind spot information System Alert Indicator: Located on the outside rearview mirror on both sides.

Comes on when:

- A vehicle enters the alert zone from behind to overtake you with a speed difference of no more than 50 km/h (31 mph) from your vehicle.
- You pass a vehicle with a speed difference of no more than 20 km/h (12 mph).

Blinks and a beeper sounds when:

You move the turn signal lever in the direction of the detected vehicle. The beeper sounds three times.

⊞ Blind spot information System*

Blind spot information system may be adversely affected when:

- Objects (guard rails, poles, trees, etc.) are detected.
- An object that does not reflect radio waves well, such as a motorcycle, is in the alert zone.
- Driving on a curved road.
- A vehicle is moving from a far lane to the adjacent lane.
- The system picks up external electrical interference.
- The rear bumper or the sensors have been improperly repaired or the rear bumper has been deformed.
- The orientation of the sensors has been changed.
- In bad weather (rain, snow, and fog).
- Driving on a bumpy road.
- Making a short turn that slightly tilts the vehicle.

For a proper blind spot information system operation:

- Always keep the rear bumper corner area clean.
- Do not cover the rear bumper corner area with labels or stickers of any kind.
- Take your vehicle to a dealer if you need the rear bumper corner area or the radar sensors to be repaired, or the rear bumper corner area is strongly impacted.

* Not available on all models

Honda Sensing is a driver support system which employs the use of two distinctly different kinds of sensors: a radar sensor located inside the front grille and a front sensor camera mounted to the interior side of the windscreen, behind the rearview mirror.

Honda Sensing has following functions.

■ The functions which do not require switch operations to activate

- Collision Mitigation Braking System (CMBS) ➤ P. 561
- Road Departure Mitigation System ➤ P. 612
- Traffic Sign Recognition System ➤ P. 618

■ The functions which require switch operations to activate

- Adaptive Cruise Control (ACC) with Low Speed Follow (LSF)* ➤ P. 572
- Adaptive Cruise Control (ACC)* ➤ P. 589
- Lane Keeping Assist System (LKAS) ➤ P. 604

■ Operation Switches for the ACC*/ACC with LSF*/LKAS

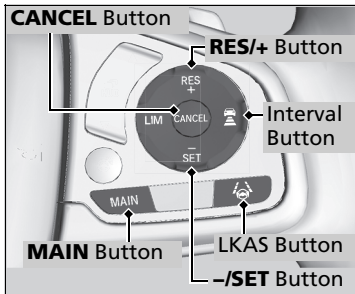

■ MAIN Button

Press to activate standby mode for ACC*, ACC with LSF*, and LKAS. Or press to cancel these systems.

■ LKAS Button

Press to activate or cancel the LKAS.

■ RES/+ and -/SET Buttons

Press **RES/+** button to resume the ACC*/ACC with LSF* or increase the vehicle speed.

Press **-/SET** button to set the ACC*/ACC with LSF* or decrease the vehicle speed.

■ Interval Button

Press the  (interval) button to change the ACC*/ACC with LSF* following-interval.

■ CANCEL Button

Press to cancel ACC*/ACC with LSF*.

■ Driver Information Interface Content

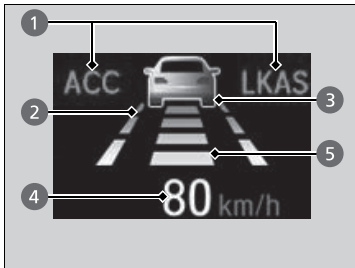

You can see the current state of ACC*, ACC with LSF*, and LKAS.

- ① Indicates that ACC*, ACC with LSF*, and LKAS are ready to be activated.
- ② Indicates that LKAS is activated and whether or not traffic lane lines are detected.
- ③ Indicates whether or not a vehicle is detected ahead.
- ④ Shows the set vehicle speed.
- ⑤ Shows the set vehicle interval.

▶▶ Driver Information Interface Content

You can have the head-up display* show you the current state of each function.

▶ **Head-up Display*** P. 170

Collision Mitigation Braking System (CMBS)

Can assist you when there is a possibility of your vehicle colliding with a vehicle or a pedestrian detected in front of yours. The CMBS is designed to alert you when a potential collision is determined, as well as to reduce your vehicle speed to help minimize collision severity when a collision is deemed unavoidable.

Collision Mitigation Braking System (CMBS)

Important Safety Reminder

The CMBS is designed to reduce the severity of an unavoidable collision. It does not prevent collision nor stop the vehicle automatically. It is still your responsibility to operate the brake pedal and steering wheel appropriately according to the driving conditions.

Manual transmission models

When the CMBS activates, the engine may stop automatically.

Start the engine by normal operation if the engine stops.

➤ **Starting the Engine** P. 514, 517

The CMBS may not activate or may not detect a vehicle in front of your vehicle under certain conditions:

➤ **CMBS Conditions and Limitations** P. 566

You can read about handling information for the camera equipped with this system.

➤ **Front Sensor Camera** P. 626

For directions on the proper handling of the radar sensor, refer to the following page.

➤ **Radar Sensor** P. 628

■ How the system works

☒ How the system works

When to use

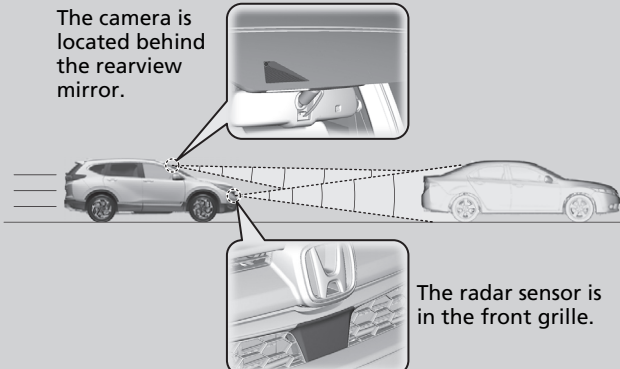

The camera is located behind the rearview mirror.

The radar sensor is in the front grille.

The system starts monitoring the roadway ahead when your vehicle speed is about 5 km/h (3 mph) and there is a vehicle in front of you.

The CMBS activates when:

- The speed difference between your vehicle and a vehicle or pedestrian detected in front of you becomes about 5 km/h (3 mph) and over with a chance of a collision.
- Your vehicle speed is about 100 km/h (62 mph) or less and the system determines there is a chance of a collision with:
 - Vehicles detected in front of you that are stationary, oncoming, or travelling in your same direction.
 - A pedestrian who is detected in front of you.
- Your vehicle speed is above 100 km/h (62 mph), and the system determines there is a chance of a collision with a vehicle detected in front of you travelling in your same direction.

When the CMBS activates, it may automatically apply the brake. It will be cancelled when your vehicle stops or a potential collision is not determined.

■ When the system activates

The system provides visual and audible alerts of a possible collision, and stops if the collision is avoided.

- ▶ Take appropriate action to prevent a collision (apply the brakes, change lanes, etc.)

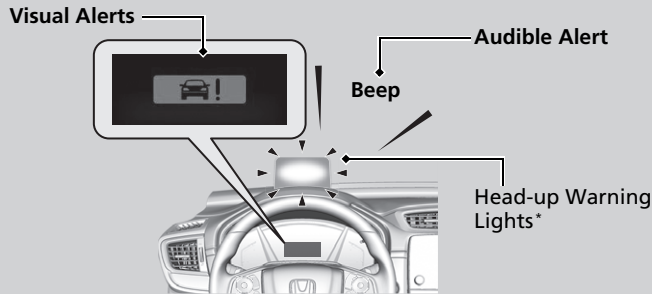

At system's earliest collision alert stage, you can change the distance (**Far/Normal/Near**) between vehicles at which alerts will come on through the driver information interface or audio/information screen setting options.

▶ **Customized Features** P. 158, 413

▶▶ How the system works

The camera in the CMBS is also designed to detect pedestrians.

However, this pedestrian detection feature may not activate or may not detect a pedestrian in front of your vehicle under certain conditions.

Refer to the ones indicating the pedestrian detection limitations from the list.

▶ **CMBS Conditions and Limitations** P. 566

The head-up warning* uses a lens located at the front end of the dashboard.

Do not cover the lens or spill any liquid on it.

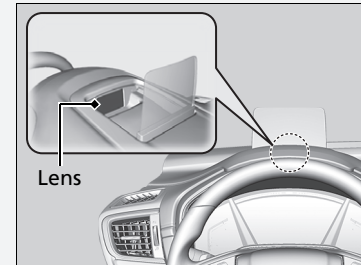

* Not available on all models

■ Collision Alert Stages

The system has three alert stages for a possible collision. However, depending on circumstances, the CMBS may not go through all of the stages before initiating the last stage.

Distance between vehicles		CMBS			
		The sensors detect a vehicle	E-pretensioner	Audible & Visual WARNINGS	Braking
Stage one		There is a risk of a collision with the vehicle ahead of you.	—	When in Far , visual and audible alerts come on at a longer distance from a vehicle ahead than in Normal setting, and in Near , at a shorter distance than in Normal .	—
Stage two		The risk of a collision has increased, time to respond is reduced.	Retracts the driver's seat belt gently a few times, providing a physical warning. 	Visual and audible alerts.	Lightly applied
Stage three		The CMBS determines that a collision is unavoidable.	Forcefully tightens driver and front passenger seat belts. 		Forcefully applied

CMBS On and Off

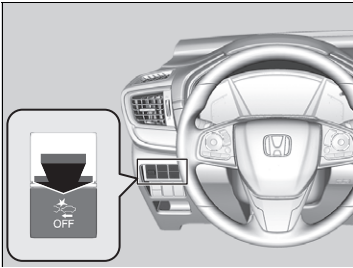

Press and hold the button until the beeper sounds to switch the system on or off.

When the CMBS is off:

- The CMBS indicator in the instrument panel comes on.
- A message on the driver information interface reminds you that the system is off.

The CMBS is turned on every time you start the engine, even if you turned it off the last time you drove the vehicle.

Collision Mitigation Braking System (CMBS)

The CMBS may automatically shut off, and the CMBS indicator will come and stay on under certain conditions.

▶ **CMBS Conditions and Limitations** P. 566

When the CMBS is activated, it will continue to operate even if the accelerator pedal is partially depressed. However, it will be cancelled if the accelerator pedal is deeply depressed.

The adaptive cruise control (ACC)*, adaptive cruise control (ACC) with low speed follow (LSF)*, road departure mitigation, vehicle stability assist (VSA) system, vehicle stability assist (VSA) OFF, low tyre pressure/deflation warning system, collision mitigation braking system (CMBS), and parking brake and brake system (amber) indicators may come on in amber along with a message in the driver information interface when you turn the ignition switch to ON **II***¹ after reconnecting the battery. Drive a short distance at more than 20 km/h (12 mph). Each indicator should go off. If any do not, have your vehicle checked by a dealer.

*1: Models with the keyless access system have an **ENGINE START/STOP** button instead of an ignition switch.

■ CMBS Conditions and Limitations

The system may automatically shut off and the CMBS indicator will come on under certain conditions. Some examples of these conditions are listed below. Other conditions may reduce some of the CMBS functions.

➤ **Front Sensor Camera** P. 626

■ Environmental conditions

- Driving in bad weather (rain, fog, snow, etc.).
- Sudden changes between light and dark, such as an entrance or exit of a tunnel.
- There is little contrast between objects and the background.
- Driving into low sunlight (e.g., at dawn or dusk).
- Strong light is reflected onto the roadway.
- Driving in the shadows of trees, buildings, etc.
- Roadway objects or structures are misinterpreted as vehicles and pedestrians.
- Reflections on the interior of the windscreen.
- Driving at night or in a dark condition such as a tunnel.

■ Roadway conditions

- Driving on a snowy or wet roadway (obscured lane marking, vehicle tracks, reflected lights, road spray, high contrast).
- Driving on curvy, winding, or undulating roads.
- The road is hilly or the vehicle is approaching the crest of a hill.

⌘ CMBS Conditions and Limitations

Have your vehicle checked by a dealer if you find any unusual behaviour of the system (e.g. the warning message appears too frequently).

■ Vehicle conditions

- Headlight lenses are dirty or the headlights are not properly adjusted.
- The outside of the windscreen is blocked by dirt, mud, leaves, wet snow, etc.
- The inside of the windscreen is fogged.
- An abnormal tyre or wheel condition (wrong sized, varied size or construction, improperly inflated, etc.).
- When tyre chains are installed.
- The vehicle is tilted due to a heavy load or suspension modifications.
- The camera temperature gets too high.
- Driving with the parking brake applied.
- When the radar sensor in the front grille gets dirty.
- The vehicle is towing a trailer.

■ Detection limitations

- A vehicle or pedestrian suddenly crosses in front of you.
- The distance between your vehicle and the vehicle or pedestrian ahead of you is too short.
- A vehicle cuts in front of you at a slow speed, and it brakes suddenly.
- When you accelerate rapidly and approach the vehicle or pedestrian ahead of you at high speed.
- The vehicle ahead of you is a motorcycle, bicycle, mobility scooter or other small vehicle.
- When there are animals in front of your vehicle.
- When you drive on a curved, winding or undulating road that makes it difficult for the sensor to properly detect a vehicle in front of you.
- The speed difference between your vehicle and a vehicle or pedestrian in front of you is significantly large.
- An oncoming vehicle suddenly comes in front of you.
- Another vehicle suddenly comes in front of you at an intersection, etc.
- Your vehicle abruptly crosses over in front of an oncoming vehicle.
- When driving through a narrow iron bridge.
- When the lead vehicle suddenly slows down.

Limitations applicable to pedestrian detection only

- When there is a group of people in front of your vehicle walking together side by side.
- Surrounding conditions or belongings of the pedestrian alter the pedestrian's shape, preventing the system from recognizing that the person is a pedestrian.
- When the pedestrian is shorter than about 1 metre or taller than about 2 metres in height.
- When a pedestrian blends in with the background.
- When a pedestrian is bent over or squatting, or when their hands are raised or they are running.
- When several pedestrians are walking ahead in a group.
- When the camera cannot correctly identify that a pedestrian is present due to an unusual shape (holding luggage, body position, size).

■ Automatic shutoff

CMBS may automatically shut itself off and the CMBS indicator comes and stays on when:

- The temperature inside the system is high.
- You drive off-road or on a mountain road, or curved and winding road for an extended period.
- An abnormal tyre condition is detected (wrong tyre size, flat tyre, etc.).
- The camera behind the rearview mirror, or the area around the camera, including the windscreen, gets dirty.

Once the conditions that caused CMBS to shut off improve or are addressed (e.g., cleaning), the system comes back on.

■ With Little Chance of a Collision

The CMBS may activate even when you are aware of a vehicle ahead of you, or when there is no vehicle ahead. Some examples of this are:

■ When Passing

Your vehicle approaches another vehicle ahead of you and you change lanes to pass.

■ At an intersection

Your vehicle approaches or passes another vehicle that is making a left or right turn.

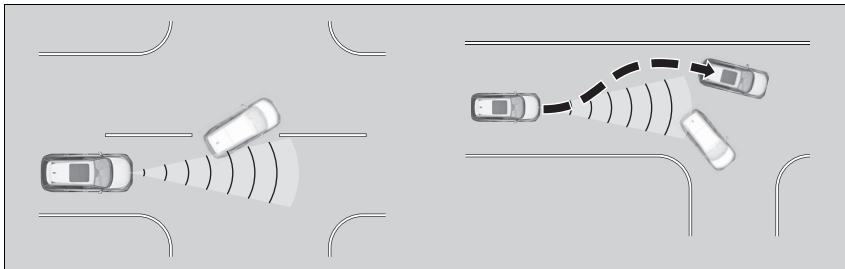

■ On a curve

When driving through curves, your vehicle comes to a point where an oncoming vehicle is right in front of you.

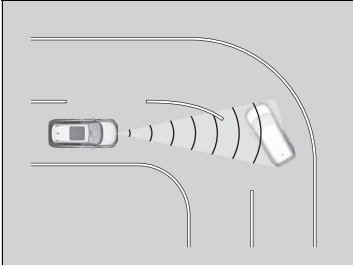
**■ Through a low bridge at high speed**

You drive under a low or narrow bridge at high speed.

■ Speed bumps, road work sites, train tracks, roadside objects, etc.

You drive over speed bumps, steel road plates, etc., or your vehicle approaches train tracks or roadside objects (such as a traffic sign and guard rail) on a curve or, when parking, stationary vehicles and walls.

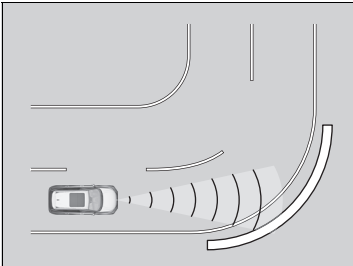

Continuously variable transmission models

Adaptive Cruise Control (ACC) with Low Speed Follow (LSF)

Helps to maintain a constant vehicle speed and a set following-interval behind a vehicle detected ahead of yours and, if the detected vehicle comes to a stop, can decelerate and stop your vehicle, without you having to keep your foot on the brake or the accelerator.

When ACC with LSF slows your vehicle by applying the brakes, your vehicle's brake lights will illuminate.

When to use

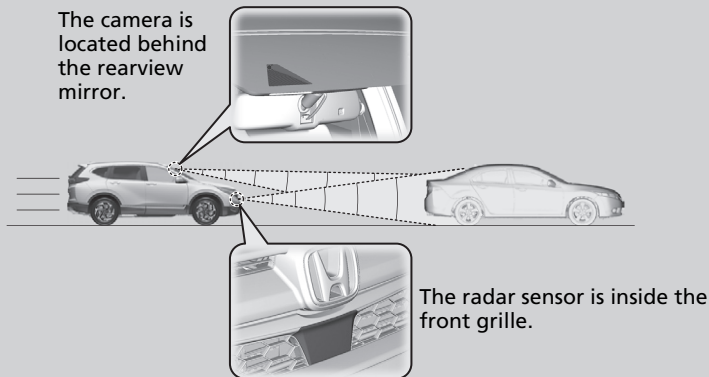

- Vehicle speed for ACC with LSF: **A vehicle is detected ahead within ACC with LSF range** – ACC with LSF operates at speeds up to 180 km/h (112 mph).
No vehicle is detected within ACC with LSF range – ACC with LSF operates at the speed of 30 km/h (18 mph) or above.
- Shift position for ACC with LSF: In **[D]** or **[S]**.

▶ Adaptive Cruise Control (ACC) with Low Speed Follow (LSF)

⚠ WARNING

Improper use of ACC with LSF can lead to a crash.

Use ACC with LSF only when driving on motorways and in good weather conditions.

⚠ WARNING

ACC with LSF has limited braking capability and may not stop your vehicle in time to avoid a collision with a vehicle that quickly stops in front of you.

Always be prepared to apply the brake pedal if the conditions require.

Important Reminder

As with any system, there are limits to ACC with LSF. Use the brake pedal whenever necessary, and always keep a safe interval between your vehicle and other vehicles.

■ How to activate the system

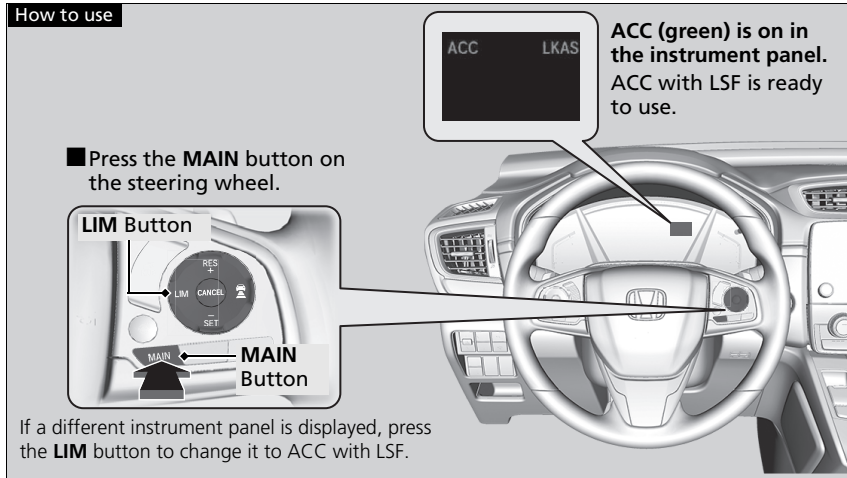

▣ Adaptive Cruise Control (ACC) with Low Speed Follow (LSF)

When the **MAIN** button is pressed, both ACC with LSF and the Lane Keeping Assist System (LKAS) are either turned on or off.

ACC with LSF may not work properly under certain conditions.

▣ ACC with LSF Conditions and Limitations P. 579

When not using ACC with LSF: Turn off adaptive cruise by pressing the **MAIN** button. This also will turn off the Lane Keeping Assist System (LKAS).

Do not use ACC with LSF under the following conditions:

- On roads with heavy traffic or while driving in continuous stop and go traffic.
- On roads with sharp turns.
- On roads with steep downhill sections, as the set vehicle speed can be exceeded by coasting. In such cases, ACC with LSF will not apply the brakes to maintain the set speed.
- On roads with toll collection facilities or other objects between lanes of traffic, or in parking areas, or facilities with drive through access.

■ To Set the Vehicle Speed

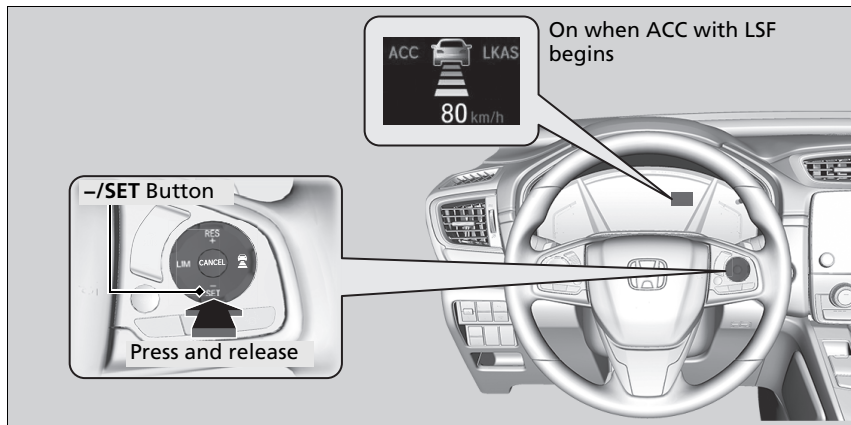

When driving at about 30 km/h (18 mph) or above: Take your foot off the pedal and press the **-/SET** button when you reach the desired speed. The moment you release the button, the set speed is fixed, and ACC with LSF begins.

When driving at slower than about 30 km/h (18 mph): If the vehicle is moving and the brake pedal is not depressed, pressing the button fixes the set speed to about 30 km/h (18 mph) regardless of current vehicle speed.

If your vehicle is stationary, you can set the vehicle speed even with the brake pedal depressed.

*1: Models with the keyless access system have an **ENGINE START/STOP** button instead of an ignition switch.

▶ Adaptive Cruise Control (ACC) with Low Speed Follow (LSF)

The adaptive cruise control (ACC) with low speed follow (LSF), road departure mitigation, vehicle stability assist (VSA) system, vehicle stability assist (VSA) OFF, low tyre pressure/deflation warning system, collision mitigation braking system (CMBS), and parking brake and brake system (amber) indicators may come on in amber along with a message in the driver information interface when you turn the ignition switch to ON **II***1 after reconnecting the battery. Drive a short distance at more than 20 km/h (12 mph). Each indicator should go off. If any do not, have your vehicle checked by a dealer.

▶ To Set the Vehicle Speed

You can switch the displayed set speed measurements on the driver information interface or audio/information screen between km/h and mph.

▶ **Speedometer** P. 147

▶ **Customized Features** P. 158, 413

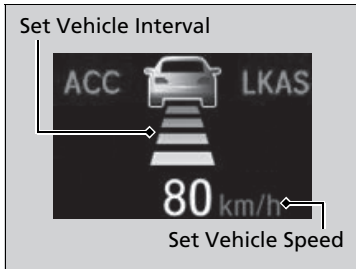

When ACC with LSF starts operating, the vehicle icon, interval bars and set speed appear on the driver information interface.

When you use ACC with LSF, Straight Driving Assist (a feature of the Electric Power Steering system) is activated.

By enabling the steering system to automatically compensate for natural steering pull, Straight Driving Assist makes it easier for you to keep your vehicle in a straight line.

■ When in Operation

■ There is a vehicle ahead

ACC with LSF monitors if a vehicle ahead of you enters the ACC with LSF range. If a vehicle is detected doing so, the ACC with LSF system maintains or decelerates your vehicle's set speed in order to keep the vehicle's set following-interval from the vehicle ahead.

➤ **To Set or Change Following-interval** P. 583

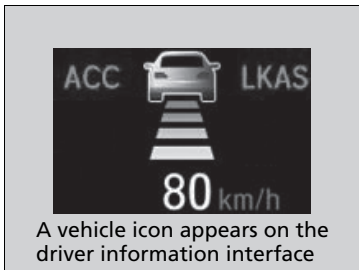
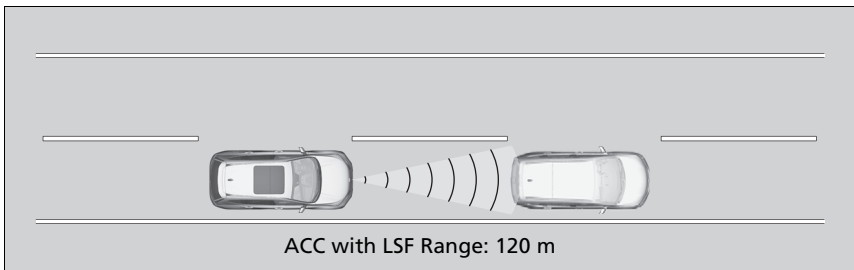

When a vehicle whose speed is slower than your set speed is detected in front of you, your vehicle starts to slow down.

⌘ When in Operation

If the vehicle ahead of you slows down abruptly, or if another vehicle cuts in front of you, the beeper sounds, a message appears on the driver information interface, and the head-up warning lights* flash.

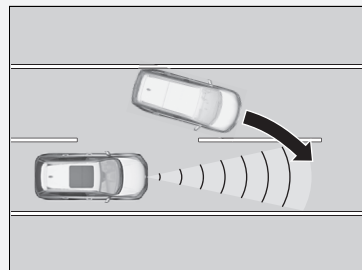

Depress the brake pedal, and keep an appropriate interval from the vehicle ahead.

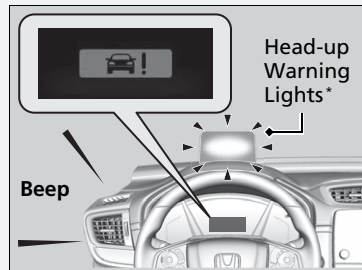

■ **There is no vehicle ahead**

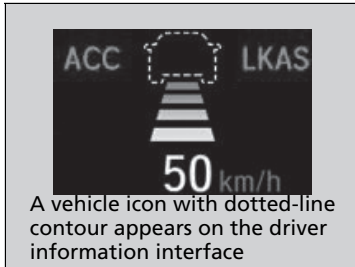

Your vehicle maintains the set speed without having to keep your foot on the brake or accelerator pedal.

If there previously was a vehicle detected ahead that kept your vehicle from travelling at the set speed, ACC with LSF accelerates your vehicle to the set speed, and then maintains it.

■ **When you depress the accelerator pedal**

You can temporarily increase the vehicle speed. In this case, there is no audible or visual alert even if a vehicle is in the ACC with LSF range. ACC with LSF stays on unless you cancel it. Once you release the accelerator pedal, the system resumes an appropriate speed for keeping the following-interval while a vehicle ahead is within the ACC with LSF range.

⌘ **When in Operation**

Even if the interval between your vehicle and the vehicle detected ahead is short, ACC with LSF may start accelerating your vehicle under the following circumstances:

- The vehicle ahead of you is going at almost the same speed as, or faster than, your vehicle.
- A vehicle that cuts in front of you is going faster than your vehicle, gradually increasing the interval between the vehicles.

You can also set the system to beep when a vehicle detected in front of you comes in and goes out of the ACC with LSF detecting range. Change the **ACC Vehicle Ahead Detected Beep** setting.

➤ **Customized Features** P. 158, 413

Limitations

You may need to use the brake to maintain a safe interval when using ACC with LSF. Additionally, ACC with LSF may not work properly under certain conditions.

➤ **ACC with LSF Conditions and Limitations**
P. 579

■ A vehicle detected ahead is within ACC with LSF range and slows to a stop



Your vehicle also stops, automatically. The **.....** message appears on the driver information interface.

When the vehicle ahead of you starts again, the vehicle icon on the driver information interface blinks. If you press the **RES/+** or **-/SET** button, or depress the accelerator pedal, ACC with LSF operates again within the prior set speed.

If no vehicle is ahead of you before you resume driving, depress the accelerator pedal and ACC with LSF will operate again within the prior set speed.

ⓘ A vehicle detected ahead is within ACC with LSF range and slows to a stop

⚠ WARNING

Exiting a vehicle that has been stopped while the ACC with LSF system is operating can result in the vehicle moving without operator control.

A vehicle that moves without operator control can cause a crash, resulting in serious injury or death.

Never exit a vehicle when the vehicle is stopped by ACC with LSF.

ACC with LSF Conditions and Limitations

The system may automatically shut off and the **ACC** indicator will come on under certain conditions. Some examples of these conditions are listed below. Other conditions may reduce some of the ACC functions.

➤ **Front Sensor Camera** P. 626

■ Environmental conditions

Driving in bad weather (rain, fog, snow, etc.).

■ Roadway conditions

Driving on a snowy or wet roadway (obscured lane marking, vehicle tracks, reflected lights, road spray, high contrast).

■ Vehicle conditions

- The outside of the windscreen is blocked by dirt, mud, leaves, wet snow, etc.
- An abnormal tyre or wheel condition (Wrong sized, varied size or construction, improperly inflated, compact spare tyre, etc.).
- The camera temperature gets too high.
- The parking brake is applied.
- When the front grille is dirty.
- The vehicle is tilted due to a heavy load or suspension modifications.
- When tyre chains are installed.

⚠ ACC with LSF Conditions and Limitations

For directions on the proper handling of the radar sensor, refer to the following page.

➤ **Radar Sensor** P. 628

You can read about handling information for the camera equipped with this system.

➤ **Front Sensor Camera** P. 626

If you need the radar sensor to be repaired, or removed, or the radar sensor cover is strongly impacted, turn off the system by pressing the **MAIN** button and take your vehicle to a dealer.

Have your vehicle checked by a dealer if you find any unusual behaviour of the system (e.g., the warning message appears too frequently).

■ Detection limitations

- A vehicle suddenly crosses in front of you.
- The interval between your vehicle and the vehicle ahead of you is too short.
- A vehicle cuts in front of you at a slow speed, and it brakes suddenly.
- When you accelerate rapidly and approach the vehicle ahead of you at high speed.
- The vehicle ahead of you is a motorcycle, bicycle, mobility scooter, or other small vehicle.
- When there are animals in front of your vehicle.
- When you drive on a curved or winding or undulating road that makes it difficult for the sensor to properly detect a vehicle in front of you.

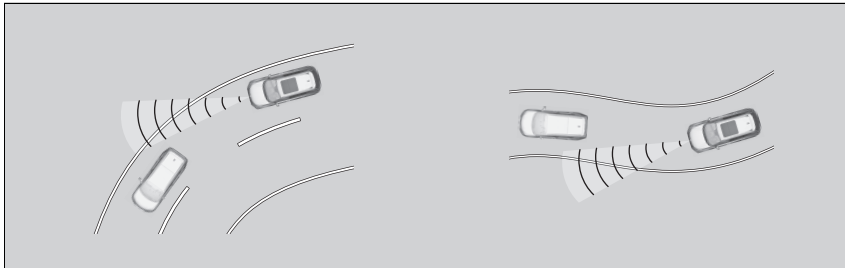

- The speed difference between your vehicle and a vehicle in front of you is significantly large.
- An oncoming vehicle suddenly comes in front of you.
- Your vehicle abruptly crosses over in front of an oncoming vehicle.

- When driving through a narrow iron bridge.



- When the vehicle ahead of you brakes suddenly.
- When the vehicle ahead of you has a unique shape.

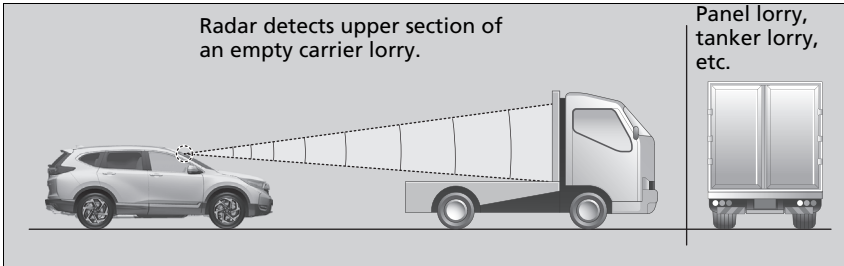

- When your vehicle or the vehicle ahead of you is driving on one edge of the lane.

■ To Adjust the Vehicle Speed

Increase or decrease the vehicle speed using the **RES/+** or **-/SET** button on the steering wheel.

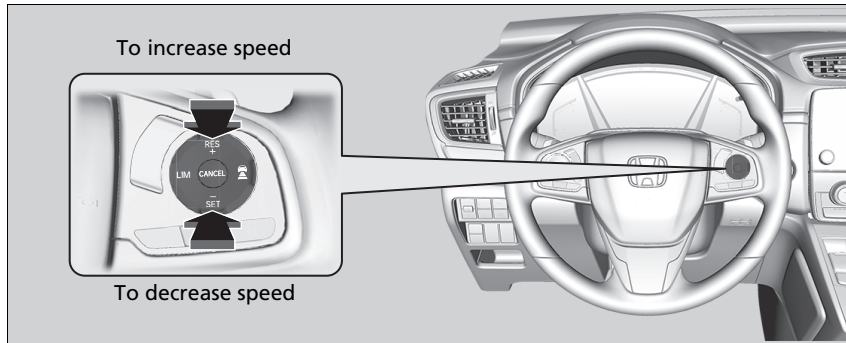

- Each time you press the **RES/+** or **-/SET** button, the vehicle speed is increased or decreased by about 1 km/h or 1 mph accordingly.
- If you press and hold the **RES/+** or **-/SET** button, the vehicle speed increases or decreases by about 10 km/h or 10 mph accordingly.

▶ To Adjust the Vehicle Speed

If a vehicle detected ahead is going at a speed slower than your increased set speed, ACC with LSF may not accelerate your vehicle. This is to maintain the set interval between your vehicle and the vehicle ahead.

When you depress the accelerator pedal and then push and release the **-/SET** button, the current speed of the vehicle is set.



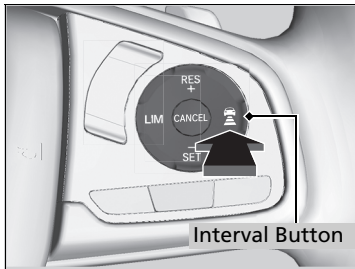

■ To Set or Change Following-interval



Press the  (interval) button to change the ACC with LSF following-interval. Each time you press the button, the following-interval (the interval behind a vehicle detected ahead of you) setting cycles through short, middle, long and extra long following-intervals.

Determine the most appropriate following-interval setting based on your specific driving conditions. Be sure to adhere to any following-interval requirements set by local regulation.

The higher your vehicle's following-speed is, the longer the short, middle, long or extra long following-interval becomes. See the following examples for your reference.

Following-interval		When the Set Speed is:	
		80 km/h (50 mph)	104 km/h (65 mph)
Short		24.7 metres 81.0 feet 1.1 sec	31.5 metres 103.3 feet 1.1 sec
Middle		34.2 metres 112.2 feet 1.5 sec	43.4 metres 142.4 feet 1.5 sec
Long		46.8 metres 153.5 feet 2.1 sec	60.8 metres 199.4 feet 2.1 sec
Extra Long		63.5 metres 208.3 feet 2.9 sec	83.4 metres 273.6 feet 2.9 sec

When your vehicle stops automatically because a vehicle detected ahead of you has stopped, the interval between the two vehicles will vary based on the ACC with LSF interval setting.

▶▶ To Set or Change Following-interval

The driver must in all circumstances preserve a sufficient braking interval from the vehicle which precedes it and be aware that minimum intervals or times of spacing can be provided by the provisions of the Motorway Code locally applicable and that it is the driver's responsibility to respect those laws.

■ To Cancel

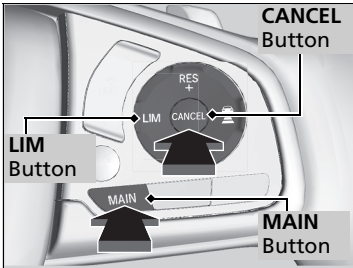

To cancel ACC with LSF, do any of the following:

- Press the **CANCEL** button.
- Press the **MAIN** button.
 - ▶ ACC with LSF indicator (green) goes off.
- Press the **LIM** button.
- Depress the brake pedal.
 - ▶ When the LSF function has stopped the vehicle, you cannot cancel ACC with LSF by depressing the brake pedal.

☒ To Cancel

Resuming the prior set speed: After you have cancelled ACC with LSF, you can resume the prior set speed while it is still displayed. Press the **RES/+** button.

The set speed cannot be set or resumed when ACC with LSF has been turned off using the **MAIN** button. Press the **MAIN** button to activate the system, then set the desired speed.

■ Automatic cancellation

The beeper sounds and a message appears on the driver information interface when ACC with LSF is automatically cancelled. Any of these conditions may cause the ACC with LSF to automatically cancel:

- Bad weather (rain, fog, snow, etc.)
- When the radar sensor in the front grille gets dirty.
- The vehicle ahead of you cannot be detected.
- An abnormal tyre condition is detected, or the tyres are skidding.
- Driving on a mountainous road, or driving off road for extended periods.
- Abrupt steering wheel movement.
- When the ABS, VSA or CMBS is activated.
- When the ABS or VSA system indicator comes on.
- When the vehicle is stopped on a very steep slope.
- When you manually apply the parking brake.
- When the detected vehicle within the ACC with LSF range is too close to your vehicle.
- The camera behind the rearview mirror, or the area around the camera, including the windscreen, gets dirty.
- When the Maximum Load Limit is exceeded.
- When passing through an enclosed space, such as tunnel.

The ACC with LSF automatic cancellation can be also triggered by the following causes. In these cases, the parking brake will be automatically applied.

- The driver's seat belt is unfastened when the vehicle is stationary.
- The vehicle stops for more than 10 minutes.
- The engine is turned off.

▶ Automatic cancellation

Even though ACC with LSF has been automatically cancelled, you can still resume the prior set speed. Wait until the condition that caused ACC with LSF to cancel improves, then press the **-/SET** button.

■ Intelligent Adaptive Cruise Control Function

Provides an early prediction for a cut-in situation. The system detects that a vehicle running in the adjacent slower lane has an intention to cut in front of you and adjusts the speed of your vehicle in advance while ACC with LSF is activated.

■ How the system works

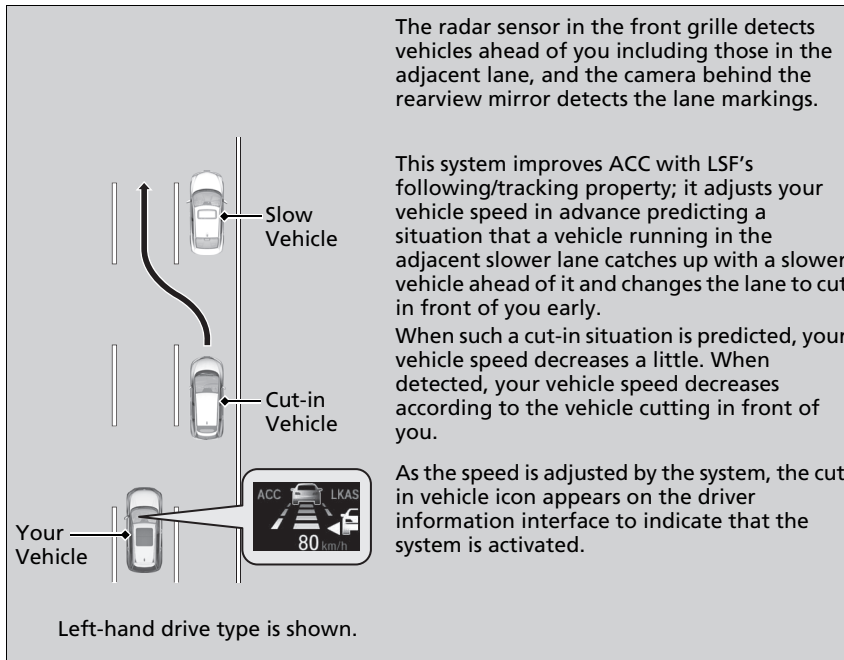

The radar sensor in the front grille detects vehicles ahead of you including those in the adjacent lane, and the camera behind the rearview mirror detects the lane markings.

This system improves ACC with LSF's following/tracking property; it adjusts your vehicle speed in advance predicting a situation that a vehicle running in the adjacent slower lane catches up with a slower vehicle ahead of it and changes the lane to cut in front of you early.

When such a cut-in situation is predicted, your vehicle speed decreases a little. When detected, your vehicle speed decreases according to the vehicle cutting in front of you.

As the speed is adjusted by the system, the cut in vehicle icon appears on the driver information interface to indicate that the system is activated.

Left-hand drive type is shown.

■ How the system activates

When a vehicle cuts in front of you is going faster than the vehicle ahead of it, and your vehicle is going faster than the cut-in vehicle (i.e., when you need to slow down), ACC with LSF predicts the cutting-in and adjust your vehicle speed.

The system activates when all the following conditions are met:

- When ACC with LSF is activated.
- When you are driving on a multi-lane road.
- When your vehicle speed is between about 80 km/h (50 mph) and about 180 km/h (112 mph).
- The vehicle is on a straight or slightly curved road.
- The turn signals are off.
- The brake pedal is not depressed.
- When a vehicle cuts in from a slower lane.

■ Intelligent adaptive cruise control on and off

You can turn the system on and off using the driver information interface.

➤ **Customized Features** P. 158, 413

☒ Intelligent Adaptive Cruise Control Function

When traffic changes from right hand side to left hand side, driving on a road where there is oncoming traffic for some distance automatically switches the lane to be detected from right to left.

Intelligent adaptive cruise control may not activate under the following conditions:

- When the speed difference between the cut-in vehicle and the vehicle ahead of it in the adjacent lane is small
- When the speed difference between the cut-in vehicle and your vehicle is small (i.e., when speed adjustment is not required)
- When a vehicle simply cuts in front of your vehicle with no vehicle ahead in the adjacent lane
- When a vehicle cuts in from a faster lane

Manual transmission models

Adaptive Cruise Control (ACC)

Helps to maintain a constant vehicle speed and a set following-interval behind a vehicle detected ahead of yours, without you having to keep your foot on the brake or the accelerator.

When ACC slows your vehicle by applying the brakes, your vehicle's brake lights will illuminate.

When to use

The camera is located behind the rearview mirror.

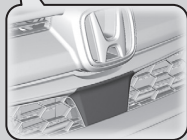
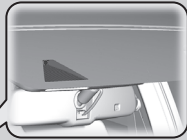

The radar sensor is inside the front grille.

- Vehicle speed for adaptive cruise control: Desired speed in a range above roughly 30 km/h (18 mph) ~
- Shift position for ACC: in **2** or higher position

Adaptive Cruise Control (ACC)

⚠ WARNING

Improper use of ACC can lead to a crash.

Use ACC only when driving on motorways and in good weather conditions.

⚠ WARNING

ACC has limited braking capability. When your vehicle speed drops below 25 km/h (15 mph), ACC will automatically cancel and no longer will apply your vehicle's brakes. Always be prepared to apply the brake pedal when conditions require.

Important Reminder

As with any system, there are limits to ACC. Use the brake pedal whenever necessary, and always keep a safe interval between your vehicle and other vehicles.

When the engine speed slows down, try to downshift.

When the engine speed goes up, try to upshift.

You can maintain the set speed if you change gear within five seconds.

■ How to activate the system

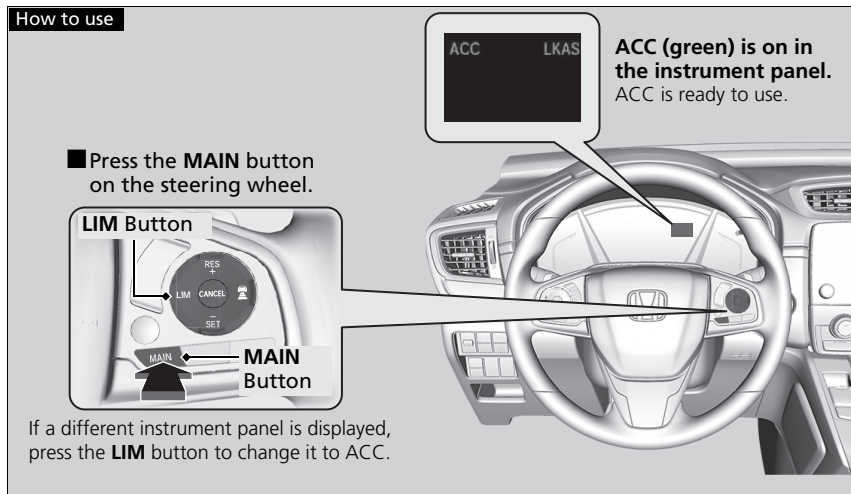

▶ Adaptive Cruise Control (ACC)

ACC may not work properly under certain conditions.

▶ ACC Conditions and Limitations P. 594

When not using ACC: Turn off adaptive cruise by pressing the **MAIN** button. This also will turn off the Lane Keeping Assist System (LKAS).

When the **MAIN** button is pressed, both ACC and the Lane Keeping Assist System (LKAS) are either turned on or off.

Do not use the ACC under the following conditions:

- On roads with heavy traffic or while driving in continuous stop and go traffic.
- On roads with sharp turns.
- On roads with steep downhill sections, as the set vehicle speed can be exceeded by coasting. In such cases, ACC will not apply the brakes to maintain the set speed.
- On roads with toll collection facilities or other objects between lanes of traffic, or in parking areas, or facilities with drive through access.

■ To Set the Vehicle Speed

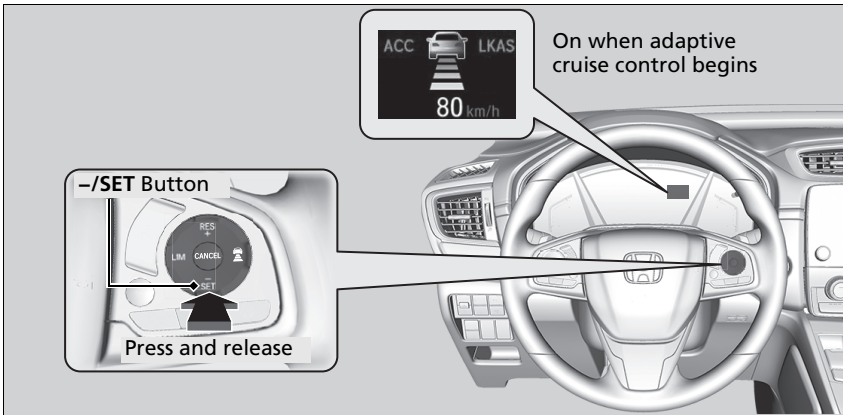

Take your foot off the pedal and press the **-/SET** button when you reach the desired speed.

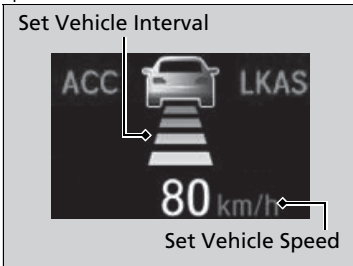

The moment you release the **-/SET** button, the set speed is fixed, and ACC begins.

When ACC starts operating, the vehicle icon, interval bars and set speed appear on the driver information interface.

When you use ACC, Straight Driving Assist (a feature of the Electric Power Steering system) is activated.

By enabling the steering system to automatically compensate for natural steering pull, Straight Driving Assist makes it easier for you to keep your vehicle in a straight line.

▣ Adaptive Cruise Control (ACC)

It may take more time to accelerate in ECON mode.

You cannot use the ACC and the adjustable speed limiter or intelligent speed limiter at the same time.

The adaptive cruise control (ACC), road departure mitigation, vehicle stability assist (VSA) system, vehicle stability assist (VSA) OFF, low tyre pressure/deflation warning system, collision mitigation braking system (CMBS), and parking brake and brake system (amber) indicators may come on in amber along with a message in the driver information interface when you turn the ignition switch to ON **II***1 after reconnecting the battery. Drive a short distance at more than 20 km/h (12 mph). Each indicator should go off. If any do not, have your vehicle checked by a dealer.

▣ To Set the Vehicle Speed

You can switch the displayed set speed measurements on the driver information interface or audio/information screen between km/h and mph.

▣ **Speedometer** P. 147

▣ **Customized Features** P. 158, 413

*1: Models with the keyless access system have an **ENGINE START/STOP** button instead of an ignition switch.

Continued

■ When in Operation

■ There is a vehicle ahead

ACC monitors if a vehicle ahead of you enters the ACC range. If a vehicle is detected doing so, the ACC system maintains or decelerates your vehicle's set speed in order to keep the vehicle's set following-interval from the vehicle ahead.

➤ **To Set or Change Following-interval** P. 598

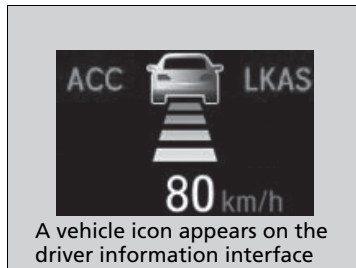
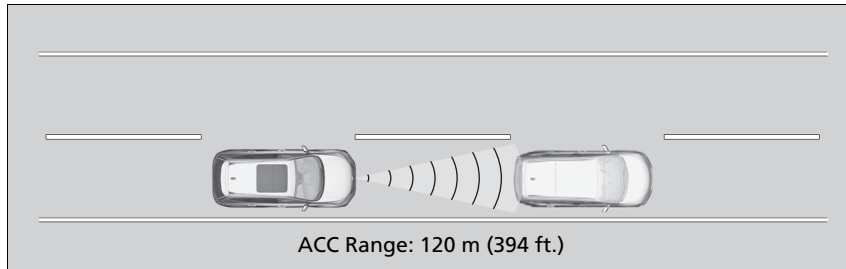

When a vehicle whose speed is slower than your set speed is detected in front of you, your vehicle starts to slow down.

⌘ When in Operation

If the vehicle ahead of you slows down abruptly, or if another vehicle cuts in front of you, the beeper sounds and a message appears on the driver information interface, and the head-up warning lights* flash.

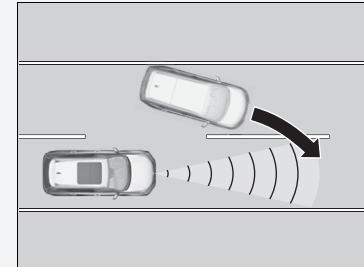

Depress the brake pedal, and keep an appropriate interval from the vehicle ahead.

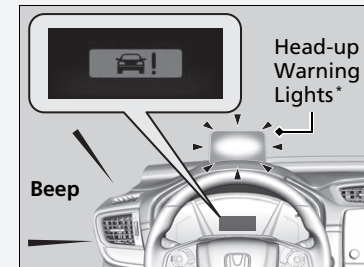

■ There is no vehicle ahead

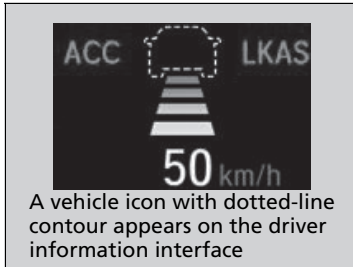

Your vehicle maintains the set speed without having to keep your foot on the brake or accelerator pedal.

If there previously was a vehicle detected ahead that kept your vehicle from travelling at the set speed, ACC accelerates your vehicle to the set speed, and then maintains it.

■ When you depress the accelerator pedal

You can temporarily increase the vehicle speed. In this case, there is no audible or visual alert even if a vehicle is in the ACC range.

ACC stays on unless you cancel it. Once you release the accelerator pedal, the system resumes an appropriate speed for keeping the following-interval while a vehicle ahead is within the ACC range.

⌘ When in Operation

Even if the interval between your vehicle and the vehicle detected ahead is short, ACC may start accelerating your vehicle under the following circumstances:

- The vehicle ahead of you is going at almost the same speed as, or faster than, your vehicle.
- A vehicle that cuts in front of you is going faster than your vehicle, gradually increasing the interval between the vehicles.

You can also set the system to beep when a vehicle detected in front of you comes in and goes out of the ACC detecting range. Change the **ACC Vehicle Ahead Detected Beep** setting.

▶ **Customized Features** P. 158, 413

Limitations

You may need to use the brake to maintain a safe interval when using ACC. Additionally, ACC may not work properly under certain conditions.

▶ **ACC Conditions and Limitations** P. 594

■ ACC Conditions and Limitations

The system may automatically shut off and the **ACC** indicator will come on under certain conditions. Some examples of these conditions are listed below. Other conditions may reduce some of the ACC functions.

➤ **Front Sensor Camera** P. 626

■ Environmental conditions

Driving in bad weather (rain, fog, snow, etc.).

■ Roadway conditions

Driving on a snowy or wet roadway (obscured lane marking, vehicle tracks, reflected lights, road spray, high contrast).

■ Vehicle conditions

- The outside of the windscreen is blocked by dirt, mud, leaves, wet snow, etc.
- An abnormal tyre or wheel condition (Wrong sized, varied size or construction, improperly inflated, compact spare tyre, etc.).
- The camera temperature gets too high.
- The parking brake is applied.
- When the front grille is dirty.
- The vehicle is tilted due to a heavy load or suspension modifications.
- When tyre chains are installed.

➤ ACC Conditions and Limitations

For directions on the proper handling of the radar sensor, refer to the following page.

➤ **Radar Sensor** P. 628

You can read about handling information for the camera equipped with this system.

➤ **Front Sensor Camera** P. 626

If you need the radar sensor to be repaired, or removed, or the radar sensor cover is strongly impacted, turn off the system by pressing the **MAIN** button and take your vehicle to a dealer.

■ Detection limitations

- A vehicle suddenly crosses in front of you.
- The interval between your vehicle and the vehicle ahead of you is too short.
- A vehicle cuts in front of you at a slow speed, and it brakes suddenly.
- When you accelerate rapidly and approach the vehicle ahead of you at high speed.
- The vehicle ahead of you is a motorcycle, bicycle, mobility scooter, or other small vehicle.
- When there are animals in front of your vehicle.
- When you drive on a curved or winding or undulating road that makes it difficult for the sensor to properly detect a vehicle in front of you.

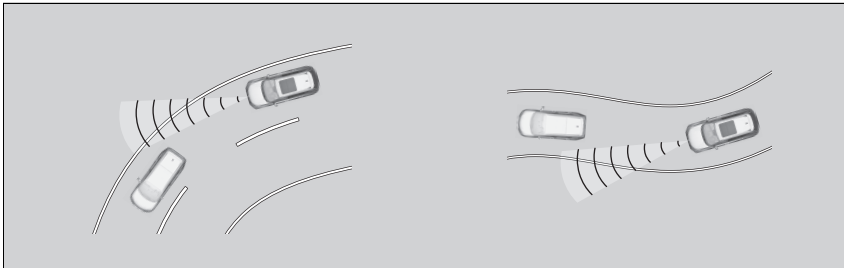

- The speed difference between your vehicle and a vehicle in front of you is significantly large.
- An oncoming vehicle suddenly comes in front of you.
- Your vehicle abruptly crosses over in front of an oncoming vehicle.

- When driving through a narrow iron bridge.

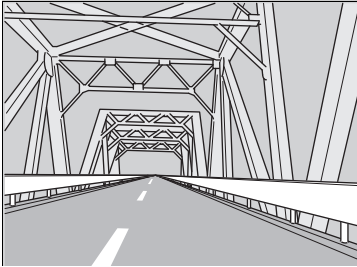

- When the vehicle ahead of you brakes suddenly.
- When the vehicle ahead of you has a unique shape.

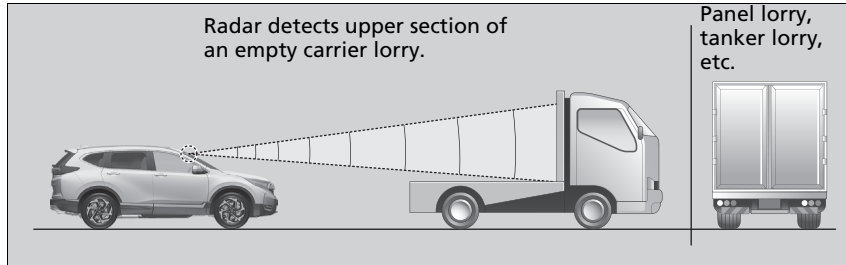

- When your vehicle or the vehicle ahead of you is driving on one edge of the lane.

■ To Adjust the Vehicle Speed

Increase or decrease the vehicle speed using the **RES/+** or **-/SET** buttons on the steering wheel.

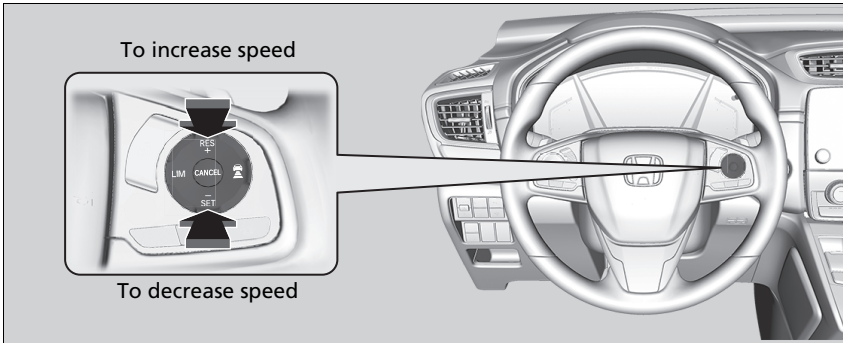

- Each time you press the **RES/+** or **-/SET** button, the vehicle speed is increased or decreased by about 1 km/h or 1 mph accordingly.
- If you keep the **RES/+** or **-/SET** button pressed, the vehicle speed increases or decreases by about 10 km/h or 10 mph accordingly.

☒ To Adjust the Vehicle Speed

If a vehicle detected ahead is going at a speed slower than your increased set speed, ACC may not accelerate your vehicle. This is to maintain the set interval between your vehicle and the vehicle ahead.

When you depress the accelerator pedal and then push and release the **-/SET** button, the current speed of the vehicle is set.

■ To Set or Change Following-interval

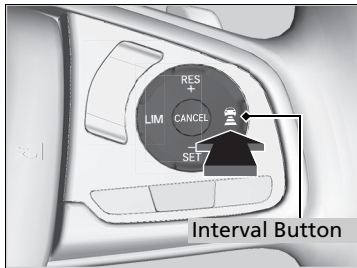

Press the  (interval) button to change ACC following-interval.

Each time you press the button, the following-interval (the interval behind a vehicle detected ahead of you) setting cycles through short, middle, long and extra long following-intervals.

Determine the most appropriate following-interval setting based on your specific driving conditions. Be sure to adhere to any following-interval requirements set by local regulation.

The higher your vehicle's following-speed is, the longer the short, middle, long or extra long following-interval becomes. See the following examples for your reference.

Following-interval		When the Set Speed is:	
		80 km/h (50 mph)	104 km/h (65 mph)
Short		25.4 metres 83.3 feet 1.1 sec	30.6 metres 100.4 feet 1.1 sec
Middle		33.4 metres 109.6 feet 1.5 sec	41.9 metres 137.4 feet 1.5 sec
Long		46.9 metres 153.8 feet 2.1 sec	60.9 metres 199.8 feet 2.1 sec
Extra Long		65.1 metres 213.5 feet 2.9 sec	86.2 metres 282.7 feet 2.9 sec

⚠ To Set or Change Following-interval

The driver must in all circumstances preserve a sufficient braking interval from the vehicle which precedes it and be aware that minimum intervals or times of spacing can be provided by the provisions of the Motorway Code locally applicable and that it is the driver's responsibility to respect those laws.

■ To Cancel

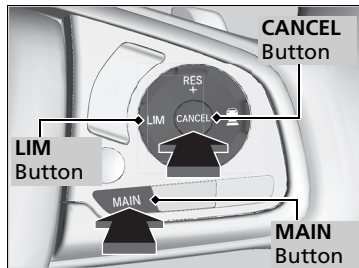

To cancel ACC, do any of the following:

- Press the **CANCEL** button.
 - ▶ ACC indicator (green) goes off.
- Press the **LIM** button.
- Depress the brake pedal.
- Depress the clutch pedal for five seconds or more.

▶▶ To Cancel

Resuming the prior set speed: After you have cancelled ACC, you can resume the prior set speed while it is still displayed. Press the **RES/+** button when driving at a speed of at least 30 km/h (18 mph) or more.

The set speed cannot be set or resumed when ACC has been turned off using the **MAIN** button. Press the **MAIN** button to activate the system, then set the desired speed.

■ Automatic cancellation

The beeper sounds and a message appears on the driver information interface when ACC is automatically cancelled. Any of these conditions may cause the ACC to be automatically cancelled.

- Bad weather (rain, fog, snow, etc.)
- When the radar sensor in the front grille gets dirty.
- The vehicle ahead of you cannot be detected.
- An abnormal tyre condition is detected, or the tyres are skidding.
- Driving on a mountainous road, or driving off road for extended periods.
- Abrupt steering wheel movement.
- When the ABS, VSA or CMBS is activated.
- When the ABS or VSA system indicator comes on.
- When you manually apply the parking brake.
- When the detected vehicle within the ACC range is too close to your vehicle.
- The camera behind the rearview mirror, or the area around the camera, including the windscreen, gets dirty.
- When the Maximum Load Limit is exceeded.
- When passing through an enclosed space, such as tunnel.
- Ignoring shift down indication shown under the tachometer will cancel the ACC after about 10 seconds.
- The engine speed goes into the tachometer's red zone.
- The engine speed goes to below 1,000 rpm.
- You shift into neutral temporarily when shifting into a higher or lower gear.

⌘ Automatic cancellation

Even though ACC has been automatically cancelled, you can still resume the prior set speed. Wait until the condition that caused ACC to cancel improves, then press the **-/SET** button.

■ Intelligent Adaptive Cruise Control Function

Provides an early prediction for a cut-in situation. The system detects that a vehicle running in the adjacent slower lane has an intention to cut in front of you and adjusts the speed of your vehicle in advance while ACC is activated.

■ How the system works

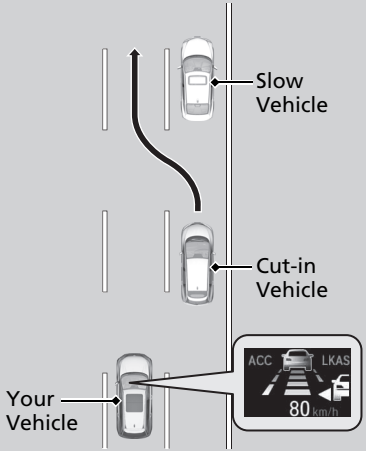

The radar sensor in the front grille detects vehicles ahead of you including those in the adjacent lane, and the camera behind the rearview mirror detects the lane markings.

This system improves ACC's following/tracking property; it adjusts your vehicle speed in advance predicting a situation that a vehicle running in the adjacent slower lane catches up with a slower vehicle ahead of it and changes the lane to cut in front of you early. When such a cut-in situation is predicted, your vehicle speed decreases a little. When detected, your vehicle speed decreases according to the vehicle cutting in front of you.

As the speed is adjusted by the system, the cut in vehicle icon appears on the driver information interface to indicate that the system is activated.

Left-hand drive type is shown.

■ How the system activates

When a vehicle cuts in front of you is going faster than the vehicle ahead of it, and your vehicle is going faster than the cut-in vehicle (i.e., when you need to slow down), ACC predicts the cutting-in and adjust your vehicle speed.

The system activates when all the following conditions are met:

- When ACC is activated.
- When you are driving on a multi-lane road.
- When your vehicle speed is between about 80 km/h (50 mph) and about 180 km/h (112 mph).
- The vehicle is on a straight or slightly curved road.
- The turn signals are off.
- The brake pedal is not depressed.
- When a vehicle cuts in from a slower lane.

■ Intelligent adaptive cruise control on and off

You can turn the system on and off using the driver information interface.

📄 **Customized Features** P. 158, 413

📄 Intelligent Adaptive Cruise Control Function

When traffic changes from right hand side to left hand side, driving on a road where there is oncoming traffic for some distance automatically switches the lane to be detected from right to left.

Intelligent adaptive cruise control may not activate under the following conditions:

- When the speed difference between the cut-in vehicle and the vehicle ahead of it in the adjacent lane is small
- When the speed difference between the cut-in vehicle and your vehicle is small (i.e., when speed adjustment is not required)
- When a vehicle simply cuts in front of your vehicle with no vehicle ahead in the adjacent lane
- When a vehicle cuts in from a faster lane

Lane Keeping Assist System (LKAS)

Provides steering input to help keep the vehicle in the middle of a detected lane and provides tactile, audible and visual alerts if the vehicle is detected drifting out of its lane.

■ Steering input assist

The system applies torque to the steering to keep the vehicle between the left and right lane lines. The applied torque becomes stronger as the vehicle gets closer to either of the lane lines.



■ Front sensor camera
Monitors the lane lines

■ Tactile, audible and visual alerts
Rapid vibrations on the steering wheel, audible and a warning display alert you that the vehicle is drifting out of a detected lane.

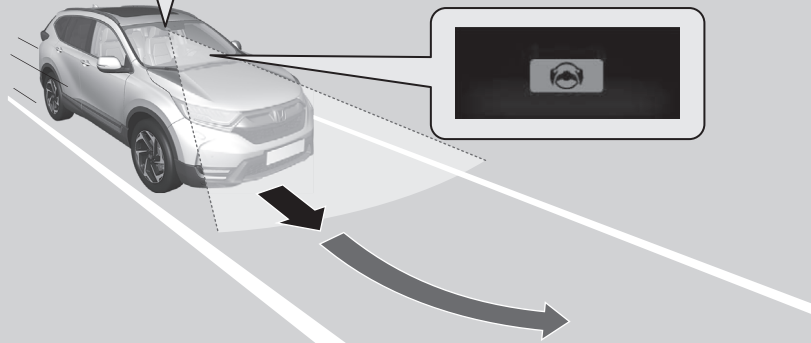
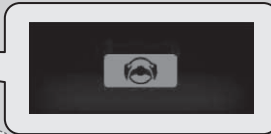

When you operate the turn signals to change lanes, the system is suspended, and resumes after the signals are off.

If you make a lane change without operating the turn signals, the LKAS alerts activate, and torque is applied to the steering.

▶ Lane Keeping Assist System (LKAS)

Important Safety Reminders

The LKAS is for your convenience only. It is not a substitute for your vehicle control. The system does not work if you take your hands off the steering wheel or fail to steer the vehicle.

▶ Driver Information Interface Warning and Information Messages P. 122

Do not place objects on the instrument panel. Objects may reflect on the front windshield and prevent correct detection of the traffic lanes.

The LKAS only alerts you when lane drift is detected without a turn signal in use. The LKAS may not detect all lane markings or lane departures; accuracy will vary based on weather, speed, and lane marker condition.

It is always your responsibility to safely operate the vehicle and avoid collisions.

The LKAS is convenient when it is used on motorways or a dual carriage way.

The LKAS may not work properly or may work improperly under the certain conditions:

▶ LKAS Conditions and Limitations P. 609

You can read about handling information for the camera equipped with this system.

▶ Front Sensor Camera P. 626

■ Lane Keep Support Function

Provides assistance to keep the vehicle in the centre of the lane, when the vehicle nears a white or yellow line, steering force of the electric power steering will become stronger.

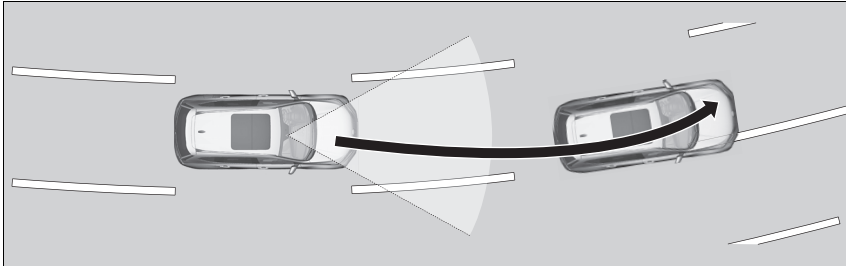

■ Lane Departure Warning Function

When the vehicle enters the warning area, the LKAS alerts you with slight steering wheel vibration, and audible and visual warnings.

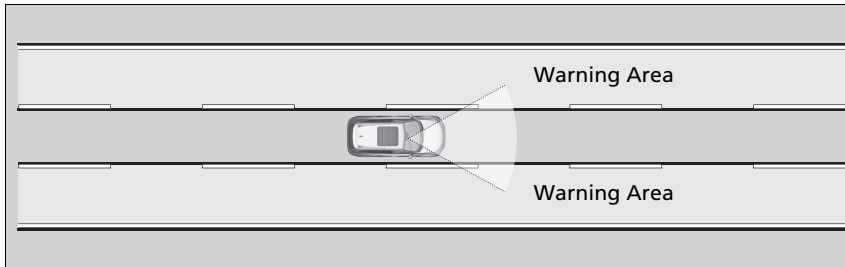

▣ Lane Keeping Assist System (LKAS)

The LKAS may not function as designed while driving in frequent stop and go traffic, or on roads with sharp curves.

When it fails to detect lanes, the system will temporarily be cancelled. When lane is detected, system will recover automatically.

■ When the System can be Used

The system can be used when the following conditions are met.

- The lane in which you are driving has detectable lane markers on both sides, and your vehicle is in the centre of the lane.
- The vehicle speed is between 72 and 185 km/h (45 and 115 mph).
- You are driving on a straight or slightly curved road.
- The turn signals are off.
- The brake pedal is not depressed.
- The wipers are not in high speed operation.

■ How to activate the system

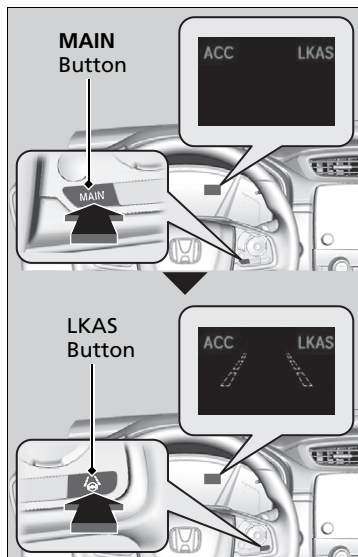

1. Press the **MAIN** button.

- ▶ The LKAS is on in the driver information interface.
The system is ready to use.

2. Press the LKAS button.

- ▶ Lane outlines appear on the driver information interface.
The system is activated.

▶▶ When the System can be Used

If the vehicle drifts towards either left or right lane line due to the system applying torque, turn off the LKAS and have your vehicle checked by a dealer.



3. Keep your vehicle near the centre of the lane while driving.
 - ▶ The dotted outer lines change to solid ones once the system starts operating after detecting the left and right lane markings.

■ To Cancel

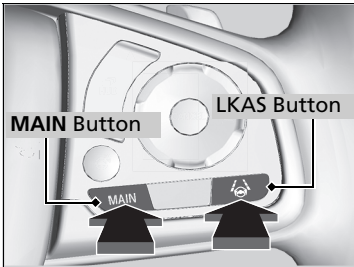

To cancel the LKAS:
Press the **MAIN** or LKAS button.

The LKAS is turned off every time you stop the engine, even if you turned it on the last time you drove the vehicle.

☒ To Cancel

Models with ACC with LSF

Pressing the **MAIN** button also turns ACC with LSF on and off.

Models with ACC

Pressing the **MAIN** button also turns ACC on and off.

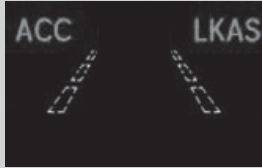

When the LKAS is suspended, the lane lines on the driver information interface change to contour lines, and the beeper sounds (if activated).

■ **The system operation is suspended if you:**

- Set the wipers to **HI**.
 - ▶ Turning the wipers off or setting it to **LO** resumes the LKAS.

Models with automatic intermittent wipers

- Set the wiper switch to **AUTO** and the wipers operate at high speed.
 - ▶ The LKAS resumes when the wipers stop or operate at low speed.

All models

- Decrease the vehicle speed to 64 km/h (40 mph) or less.
 - ▶ Increasing the vehicle speed to 72 km/h (45 mph) or more resumes the LKAS.
- Depress the brake pedal.
 - ▶ The LKAS resumes and starts detecting the lane lines again once you release the brake pedal.

■ **The LKAS may automatically be suspended when:**

- The system fails to detect lane lines.
- The steering wheel is quickly turned.
- You fail to steer the vehicle.
- Driving through a sharp curve.
- Driving at a speed in excess of approximately 185 km/h (115 mph).
- The Road Departure Mitigation System is activated.

Once these conditions no longer exist, the LKAS automatically resumes.

■ The LKAS may automatically be cancelled when:

- The camera temperature gets extremely high or low.
- The camera behind the rearview mirror, or the area around the camera, including the windshield, gets dirty.
- The ABS or VSA system engages.

The beeper sounds if the LKAS is automatically cancelled.

■ LKAS Conditions and Limitations

The system may not detect lane markings and therefore may not keep the vehicle in the middle of a lane under certain conditions, including the following:

■ Environmental conditions

- Driving in bad weather (rain, fog, snow, etc.).
- Sudden changes between light and dark, such as an entrance or exit of a tunnel.
- There is little contrast between lane lines and the roadway surface.
- Driving into low sunlight (e.g., at dawn or dusk).
- Strong light is reflected onto the roadway.
- Driving in the shadows of trees, buildings, etc.
- Shadows of adjacent objects are parallel to lane markings.
- Roadway objects or structures are misinterpreted as lane markers.
- Reflections on the interior of the windshield.
- Driving at night or in a dark condition such as a tunnel.

■ Roadway conditions

- Driving on a snowy or wet roadway (obscured lane marking, vehicle tracks, reflected lights, road spray, high contrast).
- Driving on a road with temporary lane markings.
- Faint, multiple, or varied lane markings are visible on the roadway due to road repairs or old lane markings.

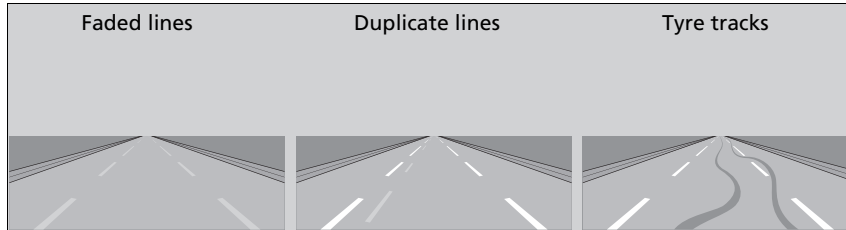

- The roadway has merging, split, or crossing lines (e.g., such as at an intersection or crosswalk).
- The lane markings are extremely narrow, wide, or changing.

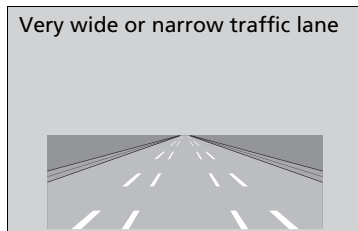

- The vehicle in front of you is driving near the lane lines.
- The road is hilly or the vehicle is approaching the crest of a hill.
- Driving on rough or unpaved roads, or over bumpy surfaces.

- When objects on the road (curb, guard rail, pylons, etc.) are recognised as white lines (or yellow lines).
- Driving on roads with double lines.

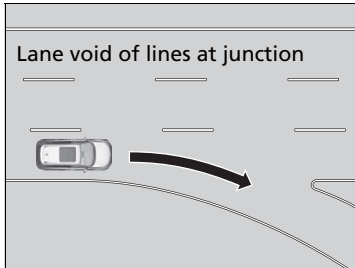

■ Vehicle conditions

- Headlight lenses are dirty or the headlights are not properly adjusted.
- The outside of the windscreen is streaked or blocked by dirt, mud, leaves, wet snow, etc.
- The inside of the windscreen is fogged.
- The camera temperature gets too high.
- An abnormal tyre or wheel condition (wrong sized, varied size or construction, improperly inflated, compact spare tyre, etc.).
- The vehicle is tilted due to a heavy load or suspension modifications.
- The vehicle is towing a trailer.

Road Departure Mitigation System

Alerts and helps to assist you when the system detects a possibility of your vehicle unintentionally crossing over detected lane markings or the edge of the pavement, or leaving the roadway altogether.

How the System Works

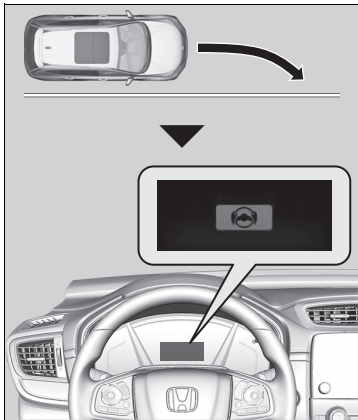

The front camera behind the rearview mirror monitors left and right lane markings (in white or yellow) and the outer edge of the pavement (bordered by grass or gravel). If your vehicle is getting too close to detected lane markings or the outer edge of the pavement (bordered by grass or gravel) without a turn signal activated, the system, in addition to a visual alert, applies steering torque and alerts you with rapid vibrations on the steering wheel, to help you remain within the detected lane.

If the system determines that the vehicle is about to veer off the edge of the pavement, it will alert the driver with an audible warning instead of steering wheel vibrations.

▶ **Customized Features** P. 158, 413

As a visual alert,  message appears on the driver information interface.

▶ Road Departure Mitigation System

Important Safety Reminder

Like all assistance systems, the Road Departure Mitigation system has limitations.

Over-reliance on the Road Departure Mitigation system may result in a collision. It is always your responsibility to keep the vehicle within your driving lane.

The Road Departure Mitigation system only alerts you when lane drift is detected without a turn signal in use. The Road Departure Mitigation system may not detect all lane markings or lane or roadway departures; accuracy will vary based on weather, speed and lane marker condition. It is always your responsibility to safely operate the vehicle and avoid collisions.

You can read about handling information for the camera equipped with this system.

▶ **Front Sensor Camera** P. 626

The Road Departure Mitigation system may not work properly or may work improperly under the certain conditions:

▶ **Road Departure Mitigation Conditions and Limitations** P. 616

There are times when you may not notice Road Departure Mitigation functions due to your operation of the vehicle, or road surface conditions.

If the system determines that its steering input is insufficient to keep your vehicle on the roadway, it may apply braking.

▶ Braking is applied only when the lane markings are solid continuous lines.

The system cancels assisting operations when you turn the steering wheel to avoid crossing over detected lane markings.

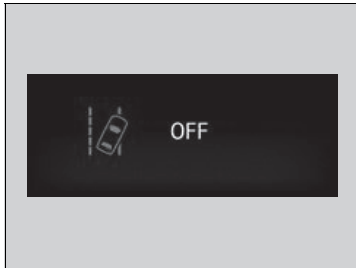

If the system operates several times without detecting driver response, the system beeps to alert you. After that, the warning to the left is displayed and the Road Departure Mitigation system is partially disabled.



After a few minutes, the message to the left is displayed and the Road Departure Mitigation system is fully restored.

⌘ Road Departure Mitigation System

If LKAS is off and you have selected **Normal** or **Early** from the customised options using the driver information interface or audio/information screen, the message below will appear if the system has determined that there is a possibility of your vehicle crossing over detected lane markings or the outer edge of the pavement (into grass or gravel border). If you have selected **Delayed**, however, the message will only appear if the vehicle is about to cross over the outer edge of the pavement.

➤ **Customized Features** P. 158, 413



■ How the System Activates

The system becomes ready to start searching for lane markings when all the following conditions are met:

- The vehicle is travelling between about 72 and 180 km/h (45 and 112 mph).
- The vehicle is on a straight or slightly curved road.
- The turn signals are off.
- The brake pedal is not depressed.
- The wipers are not in continuous operation.
- The vehicle is not accelerating or braking, and the steering wheel is not being turned.
- The system makes a determination that the driver is not actively accelerating, braking or steering.

▣ How the System Activates

The Road Departure Mitigation system may automatically shut off and the  indicator comes and stays on.

▣ **Indicators** P. 114

Road Departure Mitigation system function can be impacted when the vehicle is:

- Not driven within a traffic lane.
- Driven on the inside edge of a curve, or outside of a lane.
- Driven in a narrow lane.

Road Departure Mitigation On and Off

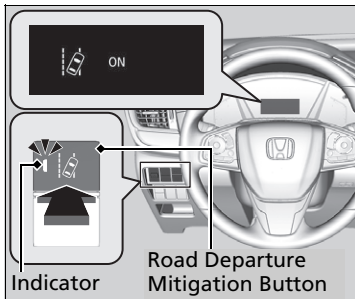

Press the Road Departure Mitigation button to turn the system on and off.

- ▶ The indicator in the button comes on and the message appears on the driver information interface when the system is on.

⊠ Road Departure Mitigation On and Off

When you have selected **Warning Only** from the customized options using the driver information interface or audio/information screen the system does not operate the steering wheel and braking.

The adaptive cruise control (ACC)*, adaptive cruise control (ACC) with low speed follow (LSF)*, road departure mitigation, vehicle stability assist (VSA) system, vehicle stability assist (VSA) OFF, low tyre pressure/deflation warning system, collision mitigation braking system (CMBS), and parking brake and brake system (amber) indicators may come on in amber along with a message in the driver information interface when you turn the ignition switch to ON **II***¹ after reconnecting the battery. Drive a short distance at more than 20 km/h (12 mph). Each indicator should go off. If any do not, have your vehicle checked by a dealer.

*1: Models with the keyless access system have an **ENGINE START/STOP** button instead of an ignition switch.

■ Road Departure Mitigation Conditions and Limitations

The system may not properly detect lane markings and the position of your vehicle under certain conditions. Some examples of these conditions are listed below.

■ Environmental conditions

- Driving in bad weather (rain, fog, snow, etc.).
- Sudden changes between light and dark, such as an entrance or exit of a tunnel.
- There is little contrast between lane lines and the roadway surface.
- Driving into low sunlight (e.g., at dawn or dusk).
- Strong light is reflected onto the roadway.
- Driving in the shadows of trees, buildings, etc.
- Shadows of adjacent objects are parallel to lane markings.
- Roadway objects or structures are misinterpreted as lane markers.
- Reflections on the interior of the windscreen.
- Driving at night or in a dark condition such as a tunnel.
- The outer edge of the pavement is bordered by objects, material etc. other than grass or gravel.

■ Roadway conditions

- Driving on a snowy or wet roadway (obscured lane marking, vehicle tracks, reflected lights, road spray, high contrast).
- Driving on a road with temporary lane markings.
- Faint, multiple, or varied lane markings are visible on the roadway due to road repairs or old lane markings.
- The roadway has merging, split, or crossing lines (e.g., such as at an intersection or crosswalk).
- The lane markings are extremely narrow, wide, or changing.
- The vehicle in front of you is driving near the lane lines.
- The road is hilly or the vehicle is approaching the crest of a hill.
- Driving on rough or unpaved roads, or over bumpy surfaces.
- When objects on the road (curb, guard rail, pylons, etc.) are recognised as white lines (or yellow lines).
- Driving on roads with double lines.

■ Vehicle conditions

- Headlight lenses are dirty or the headlights are not properly adjusted.
- The outside of the windscreen is streaked or blocked by dirt, mud, leaves, wet snow, etc.
- The inside of the windscreen is fogged.
- The camera temperature gets too high.
- An abnormal tyre or wheel condition (wrong sized, varied size or construction, improperly inflated, compact spare tyre, etc.).
- The vehicle is tilted due to a heavy load or suspension modifications.
- When tyre chains are installed.
- The vehicle is towing a trailer.

Traffic Sign Recognition System

Reminds you of road sign information, such as the current speed limit and that overtaking is prohibited, your vehicle has just passed through, showing it on the driver information interface and the head-up display*.

How the System Works

When the camera located behind the rearview mirror captures traffic signs while driving, the system displays the ones that are recognised as designated for your vehicle. The sign icon will be displayed until the vehicle reaches a predetermined time and distance.



The sign icon also may switch to another one, or disappear when:

- The end of speed limit or other designated limit is detected.
- Your vehicle enters/exists motorway or highway.
- You make a turn with a turn signal at an intersection.

Traffic Sign Recognition System

The system is designed to detect signs that follow the Vienna Convention standards. Not all signs may be displayed, but any signs posted on roadsides should not be ignored. The system does not work on the designated traffic signs of all the countries you travel, nor in all situations.

Do not rely too much on the system. Always drive at speeds appropriate for the road conditions.

Never apply a film or attach any objects to the windshield that could obstruct the camera's field of vision and cause the system to operate abnormally. Scratches, nicks, and other damage to the windshield within the camera's field of vision can cause the system to operate abnormally. If this occurs, we recommend that you replace the windshield with a genuine Honda replacement windshield. Making even minor repairs within the camera's field of vision or installing an aftermarket replacement windshield may also cause the system to operate abnormally. After replacing the windshield, have a dealer recalibrate the camera. Proper calibration of the camera is necessary for the system to operate properly.

If the system does not detect any traffic signs while you are driving, the image below may appear.

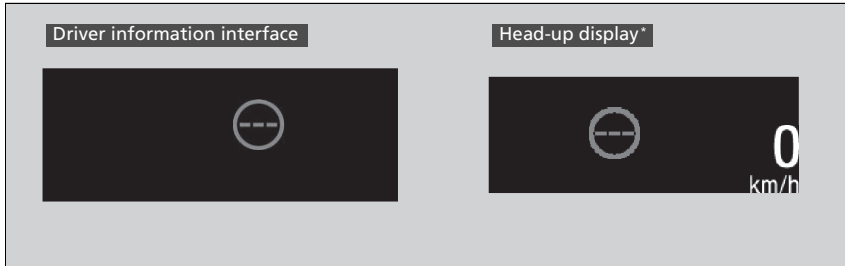

⊠ Traffic Sign Recognition System

To help reduce the likelihood that high interior temperatures will cause the camera's sensing system to shut off, when parking, find a shady area or face the front of the vehicle away from the sun. If you use a reflective sun shade, do not allow it to cover the camera housing. Covering the camera can concentrate heat on it.

If appears, the Traffic Sign Recognition System does not work, and will be displayed.

- Use the climate control system to cool down the interior and, if necessary, also use demister mode with the air flow directed towards the camera.
- Start driving the vehicle to lower the windscreen temperature, which cools down the area around the camera.

If appears, the Traffic Sign Recognition System does not work, and will be displayed.

- Park your vehicle in a safe place, and clean the windscreen. If the message does not disappear after you have cleaned the windscreen and driven for a while, have your vehicle checked by a dealer.

* Not available on all models

▶▶ Traffic Sign Recognition System

If your vehicle exceeds the detected speed limit, an icon representing the speed limit sign for the current area will blink in the display.

The system's ability to accurately notify the driver of the speed limit is dependent on certain conditions such as the units displayed on the traffic sign as well as the speed and direction of travel of the vehicle. In some cases, the system may display false warnings or other inaccurate information.

▶▶ **Traffic Sign Recognition System Conditions and Limitations** P. 621

The unit for speed limits (mph or km/h) varies from country to country. If you enter a country whose unit differs to the one of the country from which you came, use the instrument panel to change the unit, otherwise the system will not work correctly.

▶▶ **Speedometer** P. 147

▶▶ **Customized Features** P. 158, 413

■ Traffic Sign Recognition System Conditions and Limitations

The Traffic Sign Recognition system may not be able to recognise the traffic sign in the following cases.

■ Vehicle conditions

- Headlight lenses are dirty or the headlights are not properly adjusted.
- The outside of the windscreen is blocked by dirt, mud, leaves, wet snow, etc.
- The inside of the windscreen is fogged.
- There are portions remaining to be wiped.
- An abnormal tyre or wheel condition (wrong sized, varied size or construction, improperly inflated, compact spare tyre, etc.).
- The vehicle is tilted due to a heavy load or suspension modifications.

■ Environmental conditions

- Driving into low sunlight (e.g., at dawn or dusk).
- Strong light is reflected onto the roadway.
- Sudden changes between light and dark, such as an entrance or exit of a tunnel.
- When you drive in the shadows of trees, buildings, etc.
- Driving at night, in dark areas such as long tunnels.
- Driving in bad weather (rain, fog, snow, etc.).
- A vehicle in front of you is travelling flying up spray or snow.

* Not available on all models

Continued

⊠ Traffic Sign Recognition System Conditions and Limitations

When the Traffic Sign Recognition System malfunctions,  appears on the driver information interface. If this message does not disappear, have your vehicle checked by a dealer.

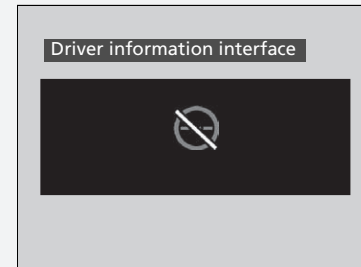

■ **The position or the condition of the traffic sign**

- A sign is hard to be found since it is in a complicated area.
- A sign is located far away from your vehicle.
- A sign is located where the beam of the headlight is hard to reach.
- A sign is on a corner or bend in the road.
- Faded or bent signs.
- Rotated or damaged signs.
- A sign is covered with mud, snow, or frost.
- A part of the sign is hidden by the trees, or the sign itself is hidden by a vehicle and others.
- Light (a streetlight) or a shadow is reflected on the surface of the sign.
- A sign is too bright or too dark (an electric sign).
- A sign of a small size.

■ **Other conditions**

- When you are driving at a high speed.

The Traffic Sign Recognition System may not operate correctly, such as displaying a sign that does not follow the actual regulation for the roadway or does not exist at all in the following cases.

- ▶ A speed limit sign may display at a higher or lower speed than the actual speed limit.
- There is a supplementary sign with further information such as weather, time, vehicle type, etc.
- Figures on the sign are hard to read (electric sign, numbers on the sign are blurred, etc.).
- A sign is in the vicinity of the lane you are driving even though it is not for the lane (speed limit sign situated at the junction between the side road and the main road, etc.).
- There are things that look similar to the colour or shape of the recognition object (similar sign, electric sign, signboard, structure, etc.).
- A lorry or another large vehicle with a sticker of the speed limit sign on the back are travelling in front of you.

■ Signs Displayed on the Driver Information Interface and Head-Up Display*

Two traffic signs can be simultaneously displayed next to each other when detected.

The speed limit sign icon is displayed on the right half of the screen. The overtaking prohibition sign icon appears on the left. Any additional sign that indicates speed limit based on weather (snow, etc.) or specific period of time can appear on either side.

■ When main mode is selected

Driver information interface



Overtaking Prohibition Sign*1
Speed Limit Sign

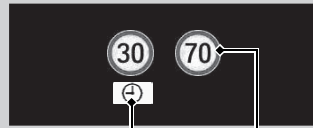

Additional Speed Limit Sign Based on Conditions*2
Speed Limit Sign

Head-up display*

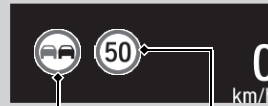

Overtaking Prohibition Sign*1
Speed Limit Sign

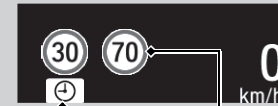

Additional Speed Limit Sign Based on Conditions*2
Speed Limit Sign

■ When main mode is not selected

Driver information interface

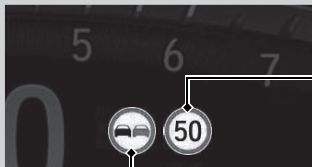

Speed Limit Sign
Overtaking Prohibition Sign*1

Head-up display*

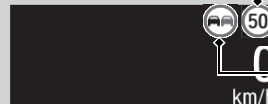

Speed Limit Sign
Overtaking Prohibition Sign*1

Depending on situation, *1 can be replaced with *2, or *2 can appear on the right side.

■ **Selecting to display traffic signs when main mode is off**

You can continue displaying reduced-size traffic sign icon on the driver information interface and head-up display* even while the main mode is not selected.

* Not available on all models

Front Sensor Camera

The camera, used in systems such as Lane Keeping Assist System (LKAS), Road Departure Mitigation System, Adaptive Cruise Control (ACC) with Low Speed Follow (LSF)*, Adaptive Cruise Control (ACC)*, Traffic Sign Recognition System, and Collision Mitigation Braking System (CMBS), is designed to detect an object that triggers any of the systems to operate its functions.

Camera Location and Handling Tips

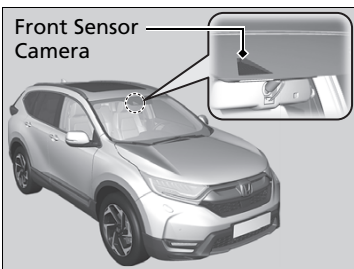

This camera is located behind the rearview mirror.

To help reduce the likelihood that high interior temperatures will cause the camera's sensing system to shut off, when parking, find a shady area or face the front of the vehicle away from the sun. If you use a reflective sun shade, do not allow it to cover the camera housing. Covering the camera can concentrate heat on it.

Front Sensor Camera

Never apply a film or attach any objects to the windshield, bonnet, or front grill that could obstruct the camera's field of vision and cause the system to operate abnormally.

Scratches, nicks, and other damage to the windshield within the camera's field of vision can cause the system to operate abnormally. If this occurs, we recommend that you replace the windshield with a genuine Honda replacement windshield. Making even minor repairs within the camera's field of vision or installing an aftermarket replacement windshield may also cause the system to operate abnormally.

After replacing the windshield, have a dealer recalibrate the camera. Proper calibration of the camera is necessary for the system to operate properly.

Do not place an object on the top of the instrument panel. It may reflect onto the windshield and prevent the system from detecting lane lines properly.

Front Sensor Camera

If the  message appears:

- Use the climate control system to cool down the interior and, if necessary, also use demister mode with the air flow directed towards the camera.
- Start driving the vehicle to lower the windscreen temperature, which cools down the area around the camera.

If the  message appears:

- Park your vehicle in a safe place, and clean the windscreen. If the message does not disappear after you have cleaned the windscreen and driven for a while, have your vehicle checked by a dealer.

Radar Sensor

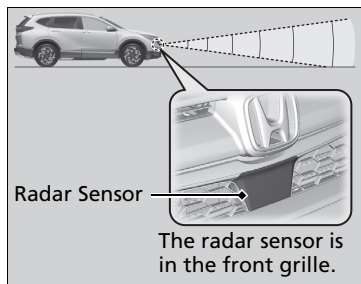

The radar sensor is in the front grille.

⚠ Radar Sensor

Avoid strong impacts to the radar sensor cover.

For the CMBS to work properly:

- Always keep the radar sensor cover clean.
- Never use chemical solvents or polishing powder for cleaning the sensor cover. Clean it with water or a mild detergent.
- Do not put a sticker on the radar sensor cover or replace the radar sensor cover.

If you need the radar sensor to be repaired, or removed, or the radar sensor cover is strongly impacted, turn off the system by using the CMBS OFF button and take your vehicle to a dealer.

➡ **CMBS On and Off** P. 565

If the vehicle is involved in any of the following situations, the radar sensor may not work properly. Have your vehicle checked by a dealer:

- Your vehicle is involved in a frontal collision.
- Your vehicle drives through deep water or is submerged in deep water.
- Your vehicle strongly strikes a bump, curb, chock, or embankment that could jar the radar sensor.

Brake System

■ Parking Brake

Use the parking brake to keep the vehicle stationary when parked. When the parking brake is applied, you can manually or automatically release it.



■ To apply

The electric parking brake can be applied any time the vehicle has battery, no matter which position the ignition switch*1 is in.

Pull the electric parking brake switch up gently and securely.

- ▶ The parking brake and brake system indicator (red) comes on.

■ To release

The ignition switch must be ON *1 in order to release the electric parking brake.

1. Depress the brake pedal.
2. Press the electric parking brake switch.
 - ▶ The parking brake and brake system indicator (red) goes off.

Manually releasing the parking brake using the switch helps your vehicle start slowly and smoothly when facing down hill on steep hills.

*1: Models with the keyless access system have an **ENGINE START/STOP** button instead of an ignition switch.

⊗ Brake System

When you depress the brake pedal, you may hear a whirling sound from the engine compartment. This is because the brake system is in operation, and it is normal.

⊗ Parking Brake

You may hear the electric parking brake system motor operating from the rear wheel area when you apply or release the parking brake. This is normal.

The brake pedal may slightly move due to the electric parking brake system operation when you apply or release the parking brake. This is normal.

You cannot apply or release the parking brake if the battery goes dead.

➤ **Jump Starting** P. 746

If you pull up and hold the electric parking brake switch while driving, the brakes on all four wheels are applied by the VSA system until the vehicle comes to a stop. The electric parking brake then applies, and the switch should be released.

Manual transmission models

The engine will not start unless the electric parking brake is engaged. If the vehicle stalls on a slope, the electric parking brake system may automatically engage. If it does not, engage it manually, then start the engine again.

Continuously variable transmission models

■ **Automatic parking brake feature operation**

If the automatic parking brake feature has been activated:

- The parking brake is applied automatically when you turn the ignition switch to LOCK [0]*1.
- To confirm that the parking brake is applied, check if the parking brake and brake system indicator is on.

➡ **Activating and deactivating the automatic parking brake feature** P. 632

■ **To release automatically**

Use the accelerator pedal to release the parking brake when you are starting the vehicle facing uphill, or in a traffic jam.

Continuously variable transmission models

Depressing the accelerator pedal releases the parking brake.

Manual transmission models

Depressing the accelerator pedal while releasing the clutch pedal releases the parking brake.

» Parking Brake

In the following situations, the parking brake automatically operates.

- When the vehicle stops with the automatic brake hold system activated for more than 10 minutes.
- When the driver's seat belt is unfastened while your vehicle is stopped and brake hold is applied.
- When the engine is turned off while the brake hold system is applied.
- When there is a problem with the Brake Hold System while the brake hold is applied.

Manual transmission models

- When there is a problem with the electric parking brake switch, after you turn the ignition switch to LOCK [0]*1.

Models with ACC with LSF

- When the vehicle is stops more than 10 minutes while ACC with LSF is activated.
- When the driver's seat belt is unfastened while your vehicle is stopped automatically by ACC with LSF.
- When the engine is turned off while ACC with LSF is activated.

*1: Models with the keyless access system have an **ENGINE START/STOP** button instead of an ignition switch.

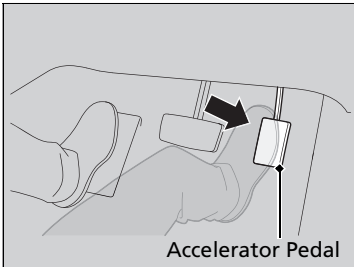

Continuously variable transmission models

Gently depress the accelerator pedal. When on a hill, it may require more accelerator input to release.

- ▶ The parking brake and brake system indicator (red) goes off.

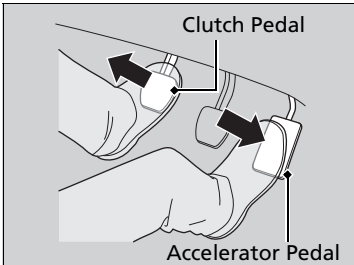

Manual transmission models

Gently depress the accelerator pedal and release the clutch pedal.

- ▶ The parking brake and brake system indicator (red) goes off.

The parking brake automatically releases as you depress the accelerator pedal when:

- You are wearing the driver's seat belt.
- The engine is running.

Continuously variable transmission models

- The transmission is not in **P** or **N**.

Manual transmission models

- The transmission is not in **N**.

▶▶ Parking Brake

If the parking brake cannot be released automatically, release it manually.

When the vehicle is travelling uphill, the accelerator pedal may need to be pressed farther to automatically release the electric parking brake.

The parking brake cannot be released automatically while the following indicators are on:

- Malfunction indicator lamp
- Transmission system indicator

The parking brake may not be released automatically while the following indicators are on:

- Brake system indicator
- VSA system indicator
- **ABS** indicator
- Supplemental restraint system indicator

Continuously variable transmission models

The parking brake is applied while the vehicle is moving with the electric parking brake switch being pulled.

Manual transmission models

The clutch pedal is fully depressed before gently depress the accelerator pedal and release the clutch pedal.

Continuously variable transmission models

■ **Activating and deactivating the automatic parking brake feature**

With the ignition switch in ON **[II]***1, carry out the following steps to either activate or deactivate the automatic parking brake feature.

1. Change the shift position to **[P]**.
2. Without depressing the brake pedal, pull up the electric parking brake switch and hold it in place.
 - Check that the parking brake and brake system indicator has come on.
3. Pull up and hold the parking brake switch. When you hear a beeping sound, release the switch and within 3 seconds pull up and hold the switch again.
4. When you hear a sound indicating that the procedure is completed, release the switch.
 - Two beeps indicates that the feature has been activated.
 - One beep indicates that the feature has been deactivated.
 - When you have completed activating the feature, the parking brake will remain applied after you turn off the engine.
 - To confirm that the parking brake is applied, check if the parking brake and brake system indicator is on.

If you need to temporarily deactivate the feature for when putting your vehicle through a conveyor type car wash or when having your vehicle towed. You can follow the procedure explained below.

1. Depress the brake pedal and bring the vehicle to a stop.
2. Turn the ignition switch to LOCK **[0]***1 and then within 2 seconds push down the electric parking brake switch.
 - Activation and deactivation settings for the feature will not be affected.
 - Before temporarily deactivating the feature, make sure to first turn off both ACC with LSF and the automatic brake hold system.
 - To confirm that the parking brake is applied, check if the parking brake and brake system indicator is on.

*1: Models with the keyless access system have an **ENGINE START/STOP** button instead of an ignition switch.

►► Activating and deactivating the automatic parking brake feature

In cold climates, the parking brake may freeze in place if applied.

When parking the vehicle, chock the wheels and make sure the automatic parking brake feature is deactivated.

Also, when putting your vehicle through a conveyor-type car wash or when having your vehicle towed, deactivate the automatic parking brake feature and leave the parking brake released.

Foot Brake

Your vehicle is equipped with disc brakes at all four wheels. The brake assist system increases the stopping force when you depress the brake pedal hard in an emergency situation. The anti-lock brake system (ABS) helps you retain steering control when braking very hard.

➤ **Brake Assist System** P. 638

➤ **Anti-lock Brake System (ABS)** P. 637

Foot Brake

Check the brakes after driving through deep water, or if there is a buildup of road surface water. If necessary, dry the brakes by lightly depressing the pedal several times.

If you hear a continuous metallic friction sound when applying the brakes, the brake pads need to be replaced. Have your vehicle checked by a dealer.

Constantly using the brake pedal while going down a long hill builds up heat, which reduces the brake effectiveness. Apply engine braking by taking your foot off the accelerator pedal and downshifting to a lower gear/speed position. With manual transmission use a lower gear for greater engine braking.

Do not rest your foot on the brake pedal while driving, as it will lightly apply the brakes and cause them to lose effectiveness over time and reduce pad life. It will also confuse drivers behind you.

Whenever the brakes are activated by CMBS or another system that automatically controls braking, the brake pedal is depressed and released in accordance with braking function.

Automatic Brake Hold

Continuously variable transmission models

Keeps the brake applied after releasing the brake pedal until the accelerator pedal is pressed. You can use this system while the vehicle is temporarily stopped, like at traffic lights and in heavy traffic.

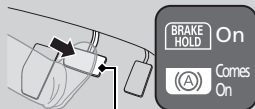
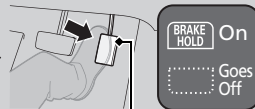
<p>■ Turning on the system</p>  <p>Automatic Brake Hold Button</p> <p>Fasten your seat belt properly, then start the engine. Press the automatic brake hold button.</p> <ul style="list-style-type: none"> The automatic brake hold system indicator comes on. The system is turned on. 	<p>■ Activating the system</p>  <p>Brake Pedal</p> <p>Depress the brake pedal to come to a complete stop. The shift lever must not be in P or R.</p> <ul style="list-style-type: none"> The automatic brake hold indicator comes on. Braking is kept for up to 10 minutes. Release the brake pedal after the automatic brake hold indicator comes on. 	<p>■ Cancelling the system</p>  <p>Accelerator Pedal</p> <p>Depress the accelerator pedal while the shift lever is in a position other than P or N. The system is cancelled and the vehicle starts to move.</p> <ul style="list-style-type: none"> The automatic brake hold indicator goes off. The system continues to be on.
--	---	---

Automatic Brake Hold

⚠ WARNING

Activating the automatic brake hold system on steep hills or slippery roads may still allow the vehicle to move if you remove your foot from the brake pedal.

If a vehicle unexpectedly moves, it may cause a crash resulting in serious injury or death.

Never activate the automatic brake hold system or rely on it to keep a vehicle from moving when stopped on a steep hill or slippery roads.

⚠ WARNING

Using the automatic brake hold system to park the vehicle may result in the vehicle unexpectedly moving.

If a vehicle moves unexpectedly, it may cause a crash, resulting in serious injury or death.



Never leave the vehicle when braking is temporarily kept by automatic brake hold and always park the vehicle by putting the transmission in **P** and applying the parking brake.

Manual transmission models

Keeps the brake applied after releasing the brake pedal until you change a gear to a position other than **N** and:

- Release the clutch pedal on a level road or when facing downhill.
- Release the clutch pedal and depress the accelerator pedal when facing uphill.

You can use this system while the vehicle is temporarily stopped, like at traffic lights and in heavy traffic.

<p>■ Turning on the system</p>  <p>Automatic Brake Hold Button</p> <p>Fasten your seat belt properly, then start the engine. Press the automatic brake hold button.</p> <ul style="list-style-type: none"> • The automatic brake hold system indicator comes on. The system is turned on. 	<p>■ Activating the system</p>  <p>Brake Pedal</p> <p>Depress the brake pedal to come to a complete stop.</p> <ul style="list-style-type: none"> • The automatic brake hold indicator comes on. Braking is kept for up to 10 minutes. • Release the brake pedal after the automatic brake hold indicator comes on. 	<p>■ Cancelling the system</p> <p>Clutch Pedal</p>  <p>Accelerator Pedal</p> <p>Shift into one of the gears other than N and:</p> <ul style="list-style-type: none"> • Release the clutch pedal on a level road or when facing downhill. • Release the clutch pedal and depress the accelerator pedal when facing uphill. <p>The system is cancelled and the vehicle starts to move.</p> <ul style="list-style-type: none"> • The automatic brake hold indicator goes off. The system continues to be on.
--	--	---

Continued

■ **The system automatically cancels when:**

- You engage the parking brake.

Continuously variable transmission models

- You depress the brake pedal and move the shift lever to **P** or **R**.

■ **The system automatically cancels and the parking brake is applied when:**

- Braking is kept for more than 10 minutes.
- The driver's seat belt is unfastened.
- The engine is turned off.
- There is a problem with automatic brake hold system.

Manual transmission models

- The engine stalls.

■ **Turning off the automatic brake hold system**

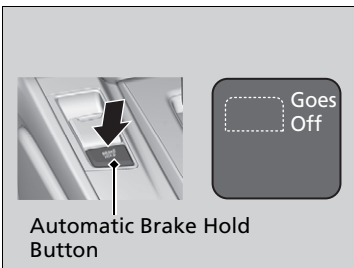

While the system is on, press the automatic brake hold button again.

- ▶ The automatic brake hold system indicator goes off.

If you want to turn off automatic brake hold while the system is in operation, press the automatic brake hold button with the brake pedal depressed.

⌘ **Automatic Brake Hold**

While the system is activated, you can turn off the engine or park the vehicle through the same procedure as you normally do.

➡ **When Stopped** P. 640

Whether the system is on, or the system is activated, the automatic brake hold turns off once the engine is off.

Manual transmission models

The system turns off if the engine stalls while automatic brake hold is active or the system is on.

Make sure to turn off the automatic brake hold system before using an automated car wash.

You may hear an operating noise if the vehicle moves while the automatic brake hold system is in operation.

Anti-lock Brake System (ABS)

■ ABS

Helps to prevent the wheels from locking up, and helps you to retain steering control by pumping the brakes rapidly, much faster than you.

The electronic brake distribution (EBD) system, which is part of the ABS, also balances the front-to-rear braking distribution according to vehicle loading.

You should never pump the brake pedal. Let the ABS work for you by always keeping firm, steady pressure on the brake pedal. This is sometimes referred to as “stomp and steer.”

■ ABS operation

The brake pedal may pulsate slightly when the ABS is working. Keep holding the pedal firmly down. On dry pavement, you will need to press on the brake pedal very hard before the ABS activates. However, you may feel the ABS activate immediately if you are trying to stop on snow or ice.

ABS may activate when you depress the brake pedal when driving on:

- Wet or snow covered roads.
- Roads paved with stone.
- Roads with uneven surfaces, such as potholes, cracks, manholes, etc.

When the vehicle speed goes under 10 km/h (6 mph), the ABS stops.

⌘ Anti-lock Brake System (ABS)

NOTICE

The ABS may not function correctly if you use a tyre of the wrong size or type.

If the **ABS** indicator comes on while driving, there may be a problem with the system. While normal braking will not be affected, there is a possibility that the ABS will not be operating. Have your vehicle checked by a dealer immediately.

The ABS is not designed for the purpose of reducing the time or distance it takes for a vehicle to stop: It is designed to limit brake lockup which can lead to skidding and loss of steering control.

In the following cases, your vehicle may need more distance to stop than a vehicle without the ABS:

- You are driving on rough or uneven road surfaces, such as gravel or snow.
- The tyres are equipped with tyre chains.

The following may be observed with the ABS system:

- Motor sounds coming from the engine compartment when the brakes are applied, or when system checks are being performed after the engine has been started and while the vehicle accelerates.
- Brake pedal and/or the vehicle body vibration when ABS activates.

These vibrations and sounds are normal to ABS systems and are no cause for concern.

Brake Assist System

Is designed to assist the driver by generating greater braking force when you depress the brake pedal hard during emergency braking.

■ Brake assist system operation

Depress the brake pedal firmly for more powerful braking.

When brake assist operates, the pedal may wiggle slightly and an operating noise may be heard. This is normal. Keep holding the brake pedal firmly down.

Emergency Stop Signal

Activates when you brake hard while driving at 60 km/h (37 mph) or above to alert drivers behind you about sudden braking by rapidly flashing hazard warning lights. This may help to alert drivers behind you to take appropriate means to avoid a possible collision with your vehicle.

■ When the system activates:

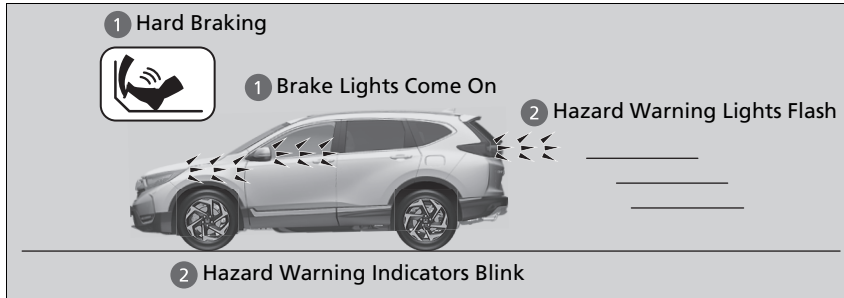

The hazard warning lights stop flashing when:

- You release the brake pedal.
- The ABS is deactivated.
- Your vehicle's decelerating speed becomes moderate.
- You press the hazard warning button.

⊠ Emergency Stop Signal

The emergency stop signal is not a system that can prevent a possible rear-end collision caused by your hard braking. It flashes the hazard warning lights at the time you are braking hard. It is always recommended to avoid hard braking unless it is absolutely necessary.

The emergency stop signal does not activate with the hazard warning button pressed in.

If the ABS stops working for a certain period during braking, the emergency stop signal may not activate at all.

When Stopped

1. Depress the brake pedal firmly.
2. With the brake pedal depressed, slowly pull the electric parking brake switch slowly, but fully.

Continuously variable transmission models

3. Change the shift position to **P**.

Manual transmission models

3. Move the shift lever to **R** or **1**.

All models

4. Turn off the engine.
 - ▶ The parking brake and brake system indicator (red) goes off in about 15 seconds.

Always confirm that the electric parking brake is set, in particular if you are parked on an incline.

When Stopped

Continuously variable transmission models

⚠ WARNING

The vehicle can roll away if left unattended without confirming that Park is engaged.

A vehicle that rolls away could cause a crash resulting in serious injury or death.

Always keep your foot on the brake pedal until you have confirmed that **P** is shown on the shift position indicator.

Do not park your vehicle near flammable objects, such as dry grass, oil, or timber. Heat from the exhaust can cause a fire.

Continuously variable transmission models

NOTICE

The following can damage the transmission:

- Depressing the accelerator and brake pedals simultaneously.
- Holding the vehicle in place when facing uphill by depressing the accelerator pedal.
- Moving the shift lever into **P** before the vehicle stops completely.

In extremely cold temperatures, the parking brake may freeze up if applied. If such temperatures are expected, do not apply the parking brake but, if parking on a slope, either turn the front wheels so they will contact the curb if the vehicle rolls down the slope or block the wheels to keep the vehicle from moving. If you do not take either precaution, the vehicle may roll unexpectedly, leading to a crash.

Parking Sensor System*

The corner and centre sensors monitor obstacles near your vehicle, and the beeper and audio/information screen let you know the approximate distance between your vehicle and the obstacle.

■ The sensor location and range

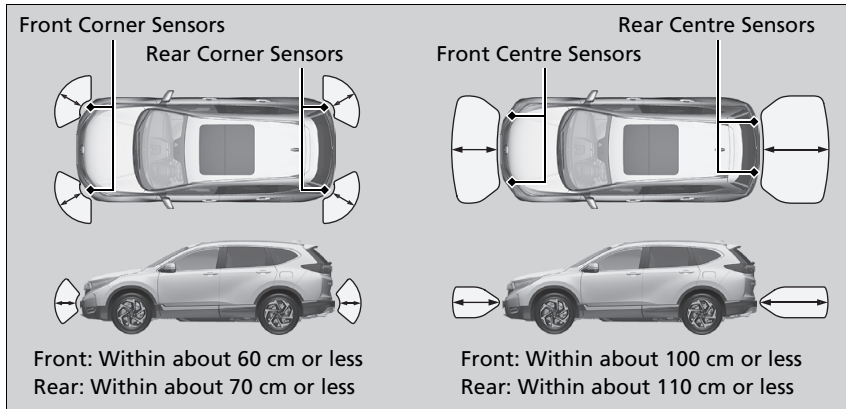

⊠ Parking Sensor System*

Even when the system is on, always confirm if there is no obstacle near your vehicle before parking.

The system may not work properly when:

- The sensors are covered with snow, ice, mud or dirt.
- The vehicle is on uneven surface, such as grass, bumps, or a hill.
- The vehicle has been out in hot or cold weather.
- The system is affected by devices that emit ultrasonic waves.
- Driving in bad weather.

The system may not sense:

- Thin or low objects.
- Sonic-absorptive materials, such as snow, cotton, or sponge.
- Objects directly under the bumper.

Do not put any accessories on or around the sensors.

* Not available on all models

■ Parking sensor system on and off

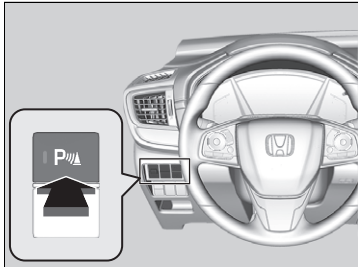

With the ignition switch is ON **[II]***1, press the parking sensor system button to turn on or off the system. The indicator in the button comes on when the system is on.

The front corner, rear centre and corner sensors start to detect an obstacle when the transmission is in **[R]**, and the vehicle speed is less than 8 km/h (5 mph).

The front centre and corner sensors start to detect an obstacle when the transmission is not in **[P]** or **[R]**, and the vehicle speed is less than 8 km/h (5 mph).

Manual transmission models

You also need to release the parking brake.

*1: Models with the keyless access system have an **ENGINE START/STOP** button instead of an ignition switch.

■ Screen Operation

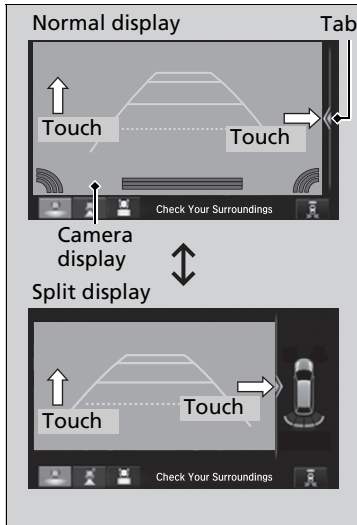

You can switch the display to normal display or split display by touching the tab vicinity or on the camera display.



▶▶ Screen Operation

If the parking sensor system is off or there is a malfunction in the system, the tab disappears, and the split display returns to the normal display.

You can also switch the display to normal display or split display using the audio/information screen.

▶▶ **Customized Features** P. 413

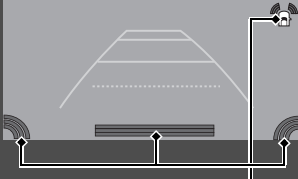
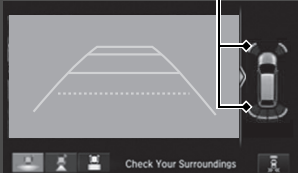
■ When the distance between your vehicle and obstacles behind becomes shorter

Length of the intermittent beep	Distance between the Bumper and Obstacle		Indicator	Driver information interface/ Audio/information screen
	Corner Sensors	Centre Sensors		
Moderate	—	Front: About 100-60 cm Rear: About 110-60 cm	Blinks in Yellow*1	 <p>Indicators light where the sensor detects an obstacle.</p>  <p>Indicators light where the sensor detects an obstacle.</p> 
Short	Front: About 60-45 cm Rear: About 70-45 cm	About 60-50 cm	Blinks in Amber	
Very short	About 45-35 cm	About 50-40 cm		
Continuous	About 35 cm or less	About 40 cm or less	Blinks in Red	

*1: At this stage, only the centre sensors detect obstacles.

■ Turning off All Rear Sensors

1. Make sure that the parking sensor system is not activated. Turn the ignition switch to LOCK [0]*1.
2. Press and hold the parking sensor system button, and set the power mode to ON.
3. Keep pressing the button for 10 seconds. Release the button when the indicator in the button flashes.
4. Press the button again. The indicator in the button goes off.
 - ▶ The beeper sounds twice. The rear sensors are now turned off.

To turn the rear sensors on again, follow the above procedure. The beeper sounds three times when the rear sensors come back on.

* 1: Models with the keyless access system have an **ENGINE START/STOP** button instead of an ignition switch.

☒ Turning off All Rear Sensors

When you shift to [R], the indicator in the parking sensor system button blinks as a reminder that the rear sensors have been turned off.

Cross Traffic Monitor*

Monitors the rear corner areas using the radar sensors when reversing, and alerts you if a vehicle approaching from a rear corner is detected.

The system is convenient especially when you are getting out of a parking space backwards.

ⓘ Cross Traffic Monitor*

WARNING

Cross traffic monitor cannot detect all approaching vehicles and may not detect an approaching vehicle at all.

Failure to visually confirm that it is safe to back up the vehicle before doing so may result in a collision.

Do not solely rely on the system when reversing; always also use your mirrors, and look behind and to the sides of your vehicle before reversing.

The parking sensor system's alerting buzzer overrides the cross traffic monitor buzzer when the sensors are detecting obstacles at the closest range.

How the System Works

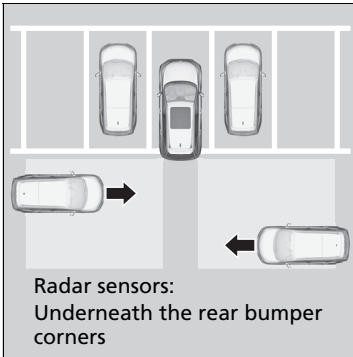

The system activates when:

- Turn the ignition switch to ON **II***1.
- The Cross Traffic Monitor is turned on.
 - ▶ **Cross Traffic Monitor On and Off** P. 650
 - ▶ **Customized Features** P. 413
- The transmission is in **R**.
- Your vehicle is moving at 5 km/h (3 mph) or lower.

When a vehicle is detected approaching from a rear corner, Cross Traffic Monitor alerts you with a buzzer and a displayed warning.

⊠ Cross Traffic Monitor*

Cross traffic monitor may not detect or may delay detecting an approaching vehicle, or may alert detection without an approaching vehicle under the following conditions:

- An obstacle, such as another vehicle and a wall, near your vehicle's rear bumper, is blocking the radar sensor's scope.
 - Your vehicle is moving at the speed of about 5 km/h (3 mph) or higher.
 - A vehicle is approaching at the speed other than between about 10 km/h (6 mph) and 25 km/h (16 mph).
 - The system picks up external interference such as other radar sensors from another vehicle or strong radio wave transmitted from a facility nearby.
 - Either corner of the rear bumper is covered with snow, ice, mud or dirt.
 - When there is bad weather.
 - Your vehicle is on an incline.
 - Your vehicle is tilted due to a heavy load in the rear.
 - Your vehicle is reversing towards a wall, a pole, a vehicle, and so on.
 - The rear bumper or the sensors have been improperly repaired or the rear bumper has been deformed.
- ▶ Have your vehicle checked by a dealer.

*1: Models with the keyless access system have an **ENGINE START/STOP** button instead of an ignition switch.

* Not available on all models

The system will not detect a vehicle that approaches from directly behind your vehicle, nor will it provide alerts about a detected vehicle when it moves directly behind your vehicle.

The system does not detect or provide alerts for a vehicle that is moving away from your vehicle, and it may detect or alert for pedestrians, bicycles, or stationary objects.

📄 Cross Traffic Monitor*

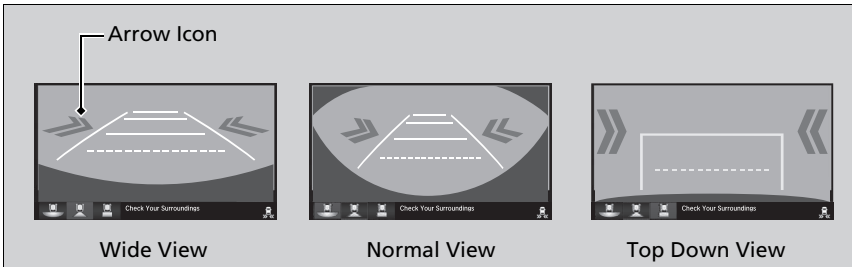

For proper operation, always keep the rear bumper corner area clean. Do not cover the rear bumper corner area with labels or stickers of any kind.

■ When the System Detects a Vehicle



An arrow icon appears on the side a vehicle is approaching on the audio/information screen.

⊞ When the System Detects a Vehicle

If the  on the lower right changes to  in amber when the transmission is in **[R]**, mud, snow, ice and other debris may have accumulated in the vicinity of the sensor. The system is temporarily cancelled. Check the bumper corners for any obstructions, and thoroughly clean the area if necessary.

If the  comes on when the transmission is in **[R]**, there may be a problem with the Cross Traffic Monitor system. Do not use the system and have your vehicle checked by a dealer.

If the display remains the same with the transmission in **[R]**, there may be a problem with the rear camera system and the Cross Traffic Monitor system. Do not use the system and have your vehicle checked by a dealer.

■ Cross Traffic Monitor On and Off

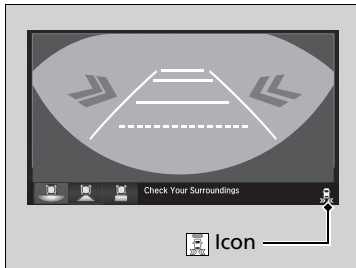

Tap to turn the system on and off. The indicator (green) comes on with the system on.

You can also switch on and off the system using the audio/information screen.

➤ **Customized Features** P. 413

About Your Multi-View Rear Camera

The audio/information screen can display your vehicle's rear view. The display automatically changes to the rear view when the transmission is put into **R**.

Multi-View Rear Camera Display Area

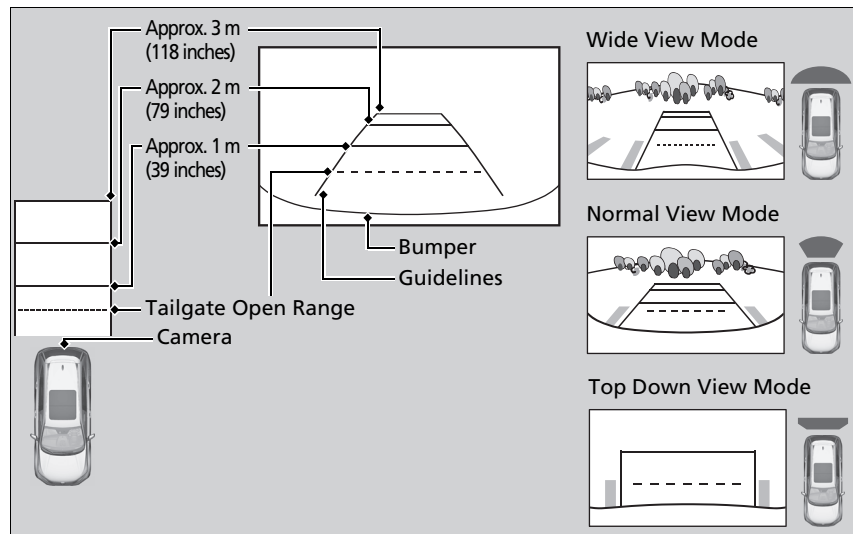

About Your Multi-View Rear Camera

The rear camera view is restricted. You cannot see the corner ends of the bumper or what is underneath the bumper. Its unique lens also makes objects appear closer or farther than they actually are.

Visually confirm that it is safe to drive before backing up. Certain conditions (such as weather, lighting, and high temperatures) may also restrict the rear view. Do not rely on the rearview display which does not give you all information about conditions at the back of your vehicle.

If the camera lens is covered with dirt or moisture, use a soft, moist cloth to keep the lens clean and free of debris.

* Not available on all models

You can view three different camera modes on the audio/information screen.

Touch the appropriate icon to switch the mode.



: Wide view mode



: Normal view mode



: Top down view mode

- If the last used viewing mode was Wide or Normal, the same view mode is selected the next time you put the transmission into **R**.
- If Top down view mode was last used before you turned off the engine, Wide View mode is selected next time you turn the ignition switch to ON **II***¹ and put the transmission into **R**.
- If Top down view mode was last used more than 10 seconds after you put the transmission out of **R**, Wide View mode is selected the next time you put the transmission into **R**.

*1: Models with the keyless access system have an **ENGINE START/STOP** button instead of an ignition switch.

▶▶ About Your Multi-View Rear Camera

You can change the **Fixed Guideline** and **Dynamic Guideline** settings.

▶ **Customized Features** P. 413

Fixed Guideline

On: Guidelines appear when you put the transmission into **R**.

Off: Guidelines do not appear.

Dynamic Guideline

On: Guidelines move according to the steering wheel direction.

Off: Guidelines do not move.

Fuel Information

■ Fuel recommendation

EN 228 standards petrol/gasohol fuel

Unleaded premium petrol/gasohol up to E10 (90% petrol and 10% ethanol), research octane number 95 or higher

Your vehicle is designed to operate on premium unleaded petrol with a research octane of 95 or higher.

If this octane grade is unavailable, regular unleaded petrol with a research octane of 91 or higher may be used temporarily.

The use of regular unleaded petrol can cause metallic knocking noises in the engine and will result in decreased engine performance. The long-term use of regular-grade petrol can lead to engine damage.

■ Fuel tank capacity: 57 L

☞ Fuel Information

NOTICE

Use of petrol that contains lead presents the following risks:

- Damage to the exhaust system including the catalytic converter
- Damage to the engine and fuel system
- Detrimental effects on the engine and other systems

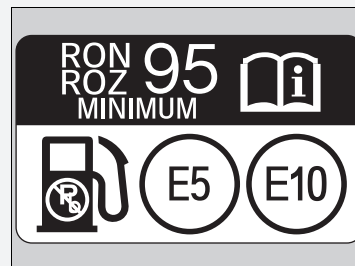

Oxygenated Fuels

Oxygenated fuels are blended with petrol and ethanol or other compounds. Your vehicle is also designed to operate on oxygenated fuels containing up to 10% ethanol by volume and up to 22% ETBE by volume, based on the EN 228 standards. For more information, ask your dealer.

How to Refuel

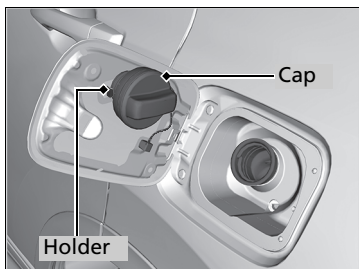
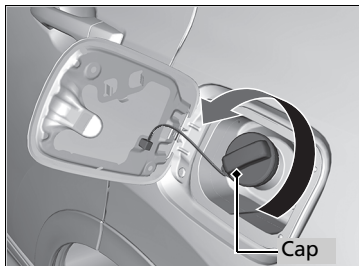
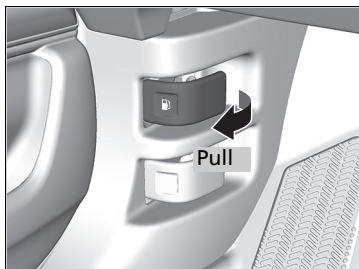

1. Stop your vehicle with the service station pump on the left side of the vehicle in the rear.
2. Turn off the engine.
3. Pull on the fuel fill door release handle under the driver's side lower outside corner of the dashboard.
 - ▶ The fuel fill door opens.
4. Remove the fuel fill cap slowly. If you hear a release of air, wait until this stops, then turn the knob slowly to open the fuel fill cap.
5. Place the fuel fill cap in the holder.
6. Insert the fuel filler nozzle fully.
 - ▶ When the tank is full, the filler nozzle will click off automatically. This leaves space in the fuel tank in case the fuel expands with a change in the temperature.
7. After filling, replace the fuel fill cap, tightening it until you hear it click at least once.
 - ▶ Shut the fuel fill door by hand.

How to Refuel

⚠ WARNING

Petrol is highly flammable and explosive. You can be burned or seriously injured when handling fuel.

- Stop the engine, and keep heat, sparks, and flame away.
- Handle fuel only outdoors.
- Wipe up spills immediately.

Do not continue to add fuel after the filler nozzle has automatically stopped. Additional fuel can exceed the full tank capacity.

The filler nozzle automatically stops to leave space in the fuel tank so that fuel does not overflow as a result of changes in air temperature.

Improving Fuel Economy and Reducing CO₂ Emissions

Achieving fuel economy and reducing CO₂ emissions is dependent on several factors, including driving conditions, load weight, idling time, driving habits, and vehicle condition. Depending on these and other factors, you may not achieve the rated fuel economy of this vehicle.

Maintenance and Fuel Economy

You can optimize your fuel economy with proper maintenance of your vehicle. Follow the maintenance schedule and, if necessary, consult your warranty booklet. On vehicles without service reminder system, follow the Maintenance schedule.

📖 Maintenance Schedule* P. 672

- Use engine oil with the viscosity recommended.
 - 📖 Recommended Engine Oil P. 683
- Maintain the specified tyre pressure.
- Do not load the vehicle with excess luggage.
- Keep your vehicle clean. A buildup of snow or mud on your vehicle's underside adds weight and increases wind resistance.

* Not available on all models

📖 Improving Fuel Economy and Reducing CO₂ Emissions

Direct calculation is the recommended method to determine actual fuel consumed while driving.

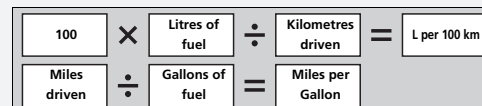

Handling Precautions

The turbocharger is a high-precision device to obtain greater horsepower by delivering a large volume of compressed air into the engine using a turbine driven by the engine's exhaust gas pressure.

- When the engine is cold just after starting, avoid revving the engine or sudden acceleration.
- Always replace the engine oil and engine oil filter according to the maintenance schedule. The turbine rotates at very high speeds over 100,000 rpm and its temperature reaches over 700°C. It is lubricated and cooled by engine oil. If you fail to replace the engine oil and filter at the scheduled distance or interval, deteriorated engine oil may cause failure such as sticking and abnormal noise of the turbine bearing.

▶ Turbo Engine Vehicle

The scheduled maintenance intervals for replacing the engine oil and filter is indicated on the driver information interface. Follow the information of when to replace them.

▶ **Service Reminder System*** P. 662

▶ **Oil Monitor System*** P. 667

▶ **Maintenance Schedule*** P. 672

▶ **Recommended Engine Oil** P. 683

The temperature gauge is at upper level when you restart the engine after driving under high load conditions such as at high speed or in hilly terrain. This is normal. The temperature gauge goes down after you idle or drive the vehicle for about one minute.

Maintenance

This chapter discusses basic maintenance.



Before Performing Maintenance

Inspection and Maintenance	658
Safety When Performing Maintenance	659
Parts and Fluids Used in Maintenance	
Service	660
About Your Maintenance Service	661
Service Reminder System*	662
Oil Monitor System*	667
Maintenance Schedule*	672
Maintenance Under the Bonnet	
Maintenance Items Under the Bonnet	680
Opening the Bonnet	681

Recommended Engine Oil	683
Oil Check	685
Adding Engine Oil	686
Engine Coolant	687
Transmission Fluid	690
Brake/Clutch* Fluid	691
Refilling Window Washer Fluid	692
Fuel Filter	693
Replacing Light Bulbs	694
Checking and Maintaining Wiper Blades	702
Checking and Maintaining Tyres	
Checking Tyres	707

Wear Indicators	708
Tyre Service Life	708
Tyre and Wheel Replacement	709
Tyre Rotation	710
Snow Traction Devices	711
Battery	712
Remote Transmitter Care	
Replacing the Button Battery	718
Climate Control System Maintenance	720
Cleaning	
Interior Care	723
Exterior Care	725
Accessories and Modifications	728

* Not available on all models

Inspection and Maintenance

For your safety, perform all listed inspections and maintenance to keep your vehicle in good condition. If you become aware of any abnormality (noise, smell, insufficient brake fluid, oil residue on the ground, etc.), have your vehicle inspected by a dealer. Refer to the Service Book* that came with your vehicle/maintenance schedule in this owner's manual for detailed maintenance and inspection information.

➤ **Maintenance Schedule*** P. 672

Types of Inspection and Maintenance

■ Daily inspections

Perform inspections before long distance trips, when washing the vehicle, or when refueling.

■ Periodic inspections

- Check the brake/clutch* fluid level monthly.
 - **Brake/Clutch* Fluid** P. 691
- Check the tyre pressure monthly. Examine the tread for wear and foreign objects.
 - **Checking and Maintaining Tyres** P. 707
- Check the operation of the exterior lights monthly.
 - **Replacing Light Bulbs** P. 694
- Check the condition of the wiper blades at least every six months.
 - **Checking and Maintaining Wiper Blades** P. 702

Safety When Performing Maintenance

Some of the most important safety precautions are given here. However, we cannot warn you of every conceivable hazard that can arise in performing maintenance. Only you can decide whether you should perform a given task.

Maintenance Safety

- To reduce the possibility of fire or explosion, keep cigarettes, sparks, and flames away from the battery and all fuel related parts.
- Never leave rags, towels, or other flammable objects under the bonnet.
 - ▶ Heat from the engine and exhaust can ignite them, causing a fire.
- To clean parts, use a commercially available degreaser or parts cleaner, not petrol.
- Wear eye protection and protective clothing when working with the battery or compressed air.
- Engine exhaust contains carbon monoxide, which is poisonous and can kill you.
 - ▶ Only operate the engine if there is sufficient ventilation.

⚠ Safety When Performing Maintenance

⚠ WARNING

Improperly maintaining this vehicle or failing to correct a problem before driving can cause a crash in which you can be seriously hurt or killed.

Always follow the inspection and maintenance recommendations and schedules in this owner's manual/Service Book.

⚠ WARNING

Failure to properly follow maintenance instructions and precautions can cause you to be seriously hurt or killed.

Always follow the procedures and precautions in this owner's manual.

■ Vehicle Safety

- The vehicle must be in a stationary condition.
 - ▶ Make sure your vehicle is parked on level ground, the parking brake is set, and the engine is off.
- Be aware that hot parts can burn you.
 - ▶ Make sure to let the engine and exhaust system cool thoroughly before touching vehicle parts.
- Be aware that moving parts can injure you.
 - ▶ Do not start the engine unless instructed, and keep your hands and limbs away from moving parts.

Models with Auto Idle Stop

- ▶ Do not open the bonnet while the Auto Idle Stop function is activated.

Parts and Fluids Used in Maintenance Service

The use of Honda genuine parts and fluids is recommended when maintaining and servicing your vehicle. Honda genuine parts are manufactured according to the same high quality standards used in Honda vehicles.

About Your Maintenance Service

If the service reminder system is available in your vehicle, you are informed by the driver information interface when your vehicle's maintenance services are due. Refer to the service book that came with your vehicle for an explanation of the service item codes that appear on the display.

➤ **Service Reminder System*** P. 662

If the service reminder system is not available, follow the maintenance schedules in the service book that came with your vehicle.

If your vehicle is without the service book, follow the maintenance schedule in this owner's manual.

➤ **Maintenance Schedule*** P. 672

⌘ About Your Maintenance Service

Models with service reminder system

If you are planning to take your vehicle outside the service reminder system applied countries, consult a dealer for how to record your service reminder information and schedule your maintenance service under the conditions of that country.

Service Reminder System*

Provides information of which service items are to be performed. Service items are represented by a code and icon. The system tells you when to take your vehicle to a dealer by days remaining.

When the next maintenance service timing is near, coming or passed, a warning icon will also appear on the driver information interface every time you turn the ignition switch to ON *1.



Service Reminder System*

You can choose to have a corresponding warning message displayed with the warning icon on the driver information interface.

*1: Models with the keyless access system have an **ENGINE START/STOP** button instead of an ignition switch.

* Not available on all models

■ Displaying the Service Reminder Information

1. Turn the ignition switch to ON *1.
2. Press the  (display/information) button several times until  is displayed.
3. Press the **ENTER** button to go to the service reminder information screen. The maintenance item(s) appears on the driver information interface.

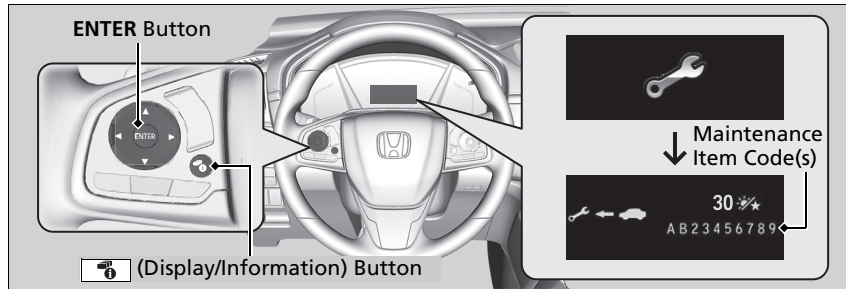

The system message indicator (①) comes on along with the service reminder information.



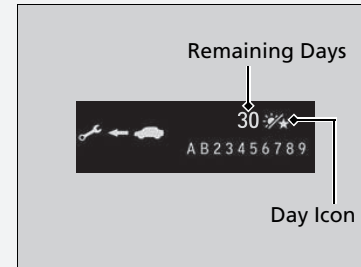

▶▶ Displaying the Service Reminder Information

Based on engine operating conditions and engine oil conditions, the system calculates the remaining days before the next service is to be performed.

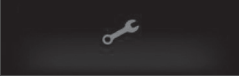

*1: Models with the keyless access system have an **ENGINE START/STOP** button instead of an ignition switch.

Warning Icons and Service Reminder Information on the Driver Information Interface

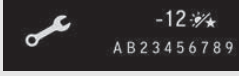
Warning Icon	Service Reminder Information	Explanation	Information
<p>Service Due Soon</p> 		<p>One or more of the service items are required in less than 30 days. The remaining days are estimated based on your driving conditions.</p>	<p>The remaining days will be counted down per day.</p>
<p>Service Due Now</p> 		<p>One or more of the service items are required in less than 10 days. The remaining days are estimated based on your driving conditions.</p>	<p>Have the indicated service performed as soon as possible.</p>
<p>Service Over Due</p> 		<p>The indicated maintenance service is still not done after the remaining time reaches 0.</p>	<p>Your vehicle has passed the service required point. Immediately have the service performed and make sure to reset the service reminder system.</p>

■ Service Reminder Items

Service items displayed on the driver information interface are in code and icon. For an explanation of the service reminder codes and icons, refer to the service book that came with your vehicle.

■ Availability of the Service Reminder System

Even if the service reminder information appears on the driver information interface while pressing the  (display/information) button, this system is not available in some countries. Refer to the service book that came with your vehicle, or ask a dealer if you can use the service reminder system.

⌘ Availability of the Service Reminder System

If you are planning to take your vehicle outside the service reminder system applied countries, consult a dealer on how to record your service reminder information and schedule your maintenance service under the conditions of that country.

■ Resetting the Display

Reset the service reminder information display if you have performed the maintenance service.

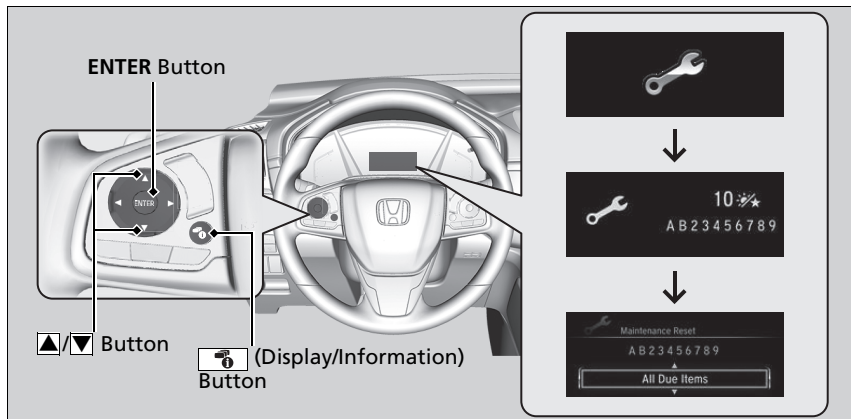

1. Turn the ignition switch to ON *1.
2. Press the (display/information) button several times until is displayed.
3. Press the **ENTER** button.
4. Press and hold the **ENTER** button for about 10 seconds to enter the reset mode.
5. Press button to select a maintenance item to reset, or to select **All Due Items** (You can also select **Cancel** to end the process).
6. Press the **ENTER** button to reset the selected item.
7. Repeat from step 4 for other items you wish to reset.

*1: Models with the keyless access system have an **ENGINE START/STOP** button instead of an ignition switch.

▶▶ Resetting the Display

NOTICE

Failure to reset the service reminder information after a maintenance service results in the system showing incorrect maintenance intervals, which can lead to serious mechanical problems.

Models with Display Audio

You can reset also the service reminder system information display using the audio/information screen.

▶ **Customized Features** P. 413

The dealer will reset the service reminder information display after completing the required maintenance service. If someone other than a dealer performs maintenance service, reset the service reminder information display yourself.

Oil Monitor System*

Models without service reminder system

The oil monitor system indicator notifies you when to change the engine oil, or when to bring your vehicle to a dealer for indicated maintenance services.

Displaying the Oil Monitor System Information

Certain maintenance items due soon, along with the estimated remaining oil life, appear on the driver information interface.

You can view them on the oil monitor system information screen at any time.

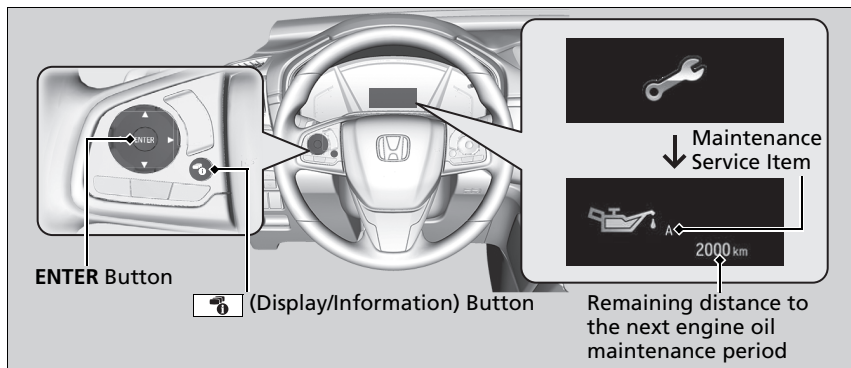

1. Turn the ignition switch to ON *1.
2. Press the (display/information) button several times until is displayed.
3. Press **ENTER** to go to the oil monitor system information screen. The maintenance service item and the remaining distance appears on the driver information interface along with maintenance items due soon.

The system message indicator () stays on in the instrument panel after the maintenance period reached. Have the indicated maintenance done by a dealer immediately.

*1: Models with the keyless access system have an **ENGINE START/STOP** button instead of an ignition switch.

▶▶ Displaying the Oil Monitor System Information

Based on the engine operating and engine oil conditions, the remaining distance to the next maintenance period is calculated and displayed.



By driving conditions, actual travel distance might be shorter than the displayed distance.





The type and content of the maintenance service items are as follows:

- A. Replace engine oil
- B. Replace engine oil and oil filter

Independent of the oil monitor system information, perform maintenance after 1 year has elapsed since the last oil change.

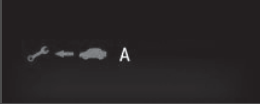
Oil Monitor System Information on the Driver Information Interface

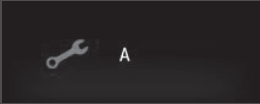
Warning Message	Oil Life Display	Information
<p>NORMAL</p> <p>—</p>		<p>When you reset the remaining distance after an oil change, a series of dots will appear in the oil life display. These dots will remain displayed until the system determines, based on the driving conditions, the remaining distance until the next oil change, or the next oil and filter change.</p>
		<p>When you select the oil monitor system information screen, the remaining engine oil life, or the remaining engine oil and oil filter life is displayed.</p>

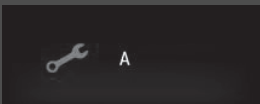
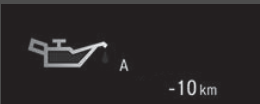
Warning Message	Oil Life Display	Information
<p>SERVICE DUE SOON</p> 		<p>The engine oil, or the oil filter and engine oil are approaching the end of their life.</p>
<p>SERVICE DUE NOW</p> 		<p>The engine oil, or the engine oil and oil filter have almost reached the end of their service life, and the maintenance service item(s) must be inspected and serviced as soon as possible.</p>
<p>SERVICE OVER DUE</p> 		<p>The engine oil, or the oil filter and engine oil have passed their service life. The maintenance service item(s) must be inspected and serviced immediately.</p>

Resetting the Display

Reset the engine oil monitor system information if you have performed the maintenance service.

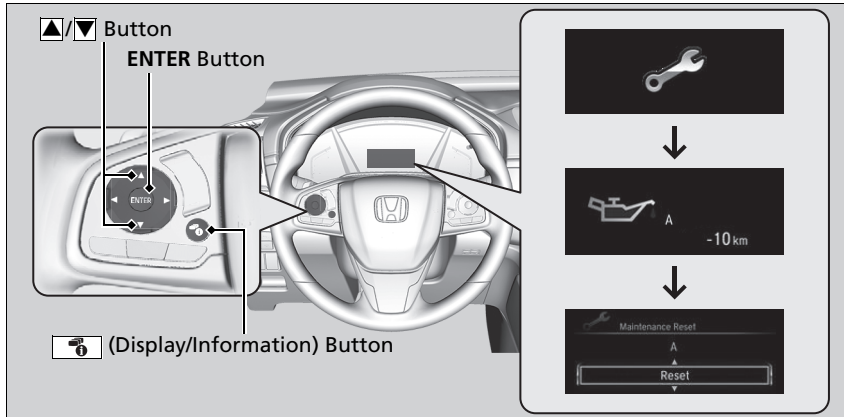

1. Turn the ignition switch to ON *1.
2. Press the (display/information) button several times until is displayed.
3. Press **ENTER** button to go to the oil monitor system information screen.
4. Press and hold the **ENTER** button for about 10 seconds to enter the reset mode.
5. Press button to select **Reset**.
(You can also select **Cancel** to end the process).
6. Press the **ENTER** button to reset the selected item.

*1: Models with the keyless access system have an **ENGINE START/STOP** button instead of an ignition switch.

Resetting the Display

NOTICE

Failure to reset the engine oil life after a maintenance service results in the system showing incorrect maintenance intervals, which can lead to serious mechanical problems.

Models with Display Audio

You can reset also the oil monitor system information display using the audio/information screen.

Customized Features P. 413

The dealer will reset the engine oil life display after completing the required maintenance service. If someone other than a dealer performs maintenance service, reset the engine oil life display yourself.

If your vehicle comes with the service book, the maintenance schedule for your vehicle is available in the book. For vehicles without the service book, refer to the following maintenance schedules.

The maintenance schedule outlines the minimum required maintenance that you should perform to ensure the troublefree operation of your vehicle. Due to regional and climatic differences, some additional servicing may be required. Please consult your warranty booklet for a more detailed description.

Maintenance work should be performed by properly trained and equipped technicians. Your authorised dealer meets all of these requirements.

Except European and Ukrainian models

Service at the indicated distance or time - whichever comes first.	km X 1,000	20	40	60	80	100	120	140	160	180	200
	miles X 1,000	12.5	25.0	37.5	50.0	62.5	75.0	87.5	100.0	112.5	125.0
	months	12	24	36	48	60	72	84	96	108	120
Replace engine oil* ¹	When indicator comes on or 1 year										
Replace engine oil filter* ¹	When indicator comes on or 2 years										
Add genuine injector cleaner agent* ²	Every 10,000 km (6,000 miles) or 1 year										
Replace air cleaner element	Every 30,000 km (18,500 miles)										
Inspect valve clearance	Every 120,000 km (75,000 miles)* ³										
Replace fuel filter* ⁵	Normal	Every 180,000 km (112,500 miles)									
	Severe	Every 110,000 km (68,500 miles)* ⁴									
Replace spark plugs	Every 100,000 km (62,500 miles)										
Inspect drive belts		•		•		•		•		•	
Replace engine coolant	At 200,000 km (125,000 miles) or 10 years, thereafter every 100,000 km (62,500 miles) or 5 years										

*1: Only severe schedule is required in some countries: refer to the local warranty booklet.

*2: Regular use of injector cleaner may be required for models designated for the following countries, it will depend on the quality of the fuel used. Consult your dealer for details: Reunion, Melilla, Ceuta, Canary Islands

*3: Sensory Method

Adjust the valves during service 120,000 km (75,000 miles) if they are noisy.

*4: It is recommended to replace the fuel filter if the fuel you are using is suspected to be contaminated with dust, etc. because the filter may be clogged sooner.

*5: Refer to page 693 for replacement information under driving conditions.

Service at the indicated distance or time - whichever comes first.	km X 1,000	20	40	60	80	100	120	140	160	180	200
	miles X 1,000	12.5	25.0	37.5	50.0	62.5	75.0	87.5	100.0	112.5	125.0
	months	12	24	36	48	60	72	84	96	108	120
Replace transmission fluid	MT Normal	Every 120,000 km (75,000 miles) or 6 years									
	Severe			•			•			•	
	CVT		•		•		•		•		•
Replace rear differential fluid	AWD	•				•				•	
Inspect front and rear brakes	Every 10,000 km (6,000 miles) or 6 months										
Replace brake fluid	Every 3 years										
Replace dust and pollen filter	•	•	•	•	•	•	•	•	•	•	•
Rotate tyres (Check tyre inflation and condition at least once per month)	Every 10,000 km (6,000 miles)										
Visually inspect the following items:											
Tie rod ends, steering gearbox, and boots											
Suspension components	Every 10,000 km (6,000 miles) or 6 months										
Driveshaft boots											
Brake hoses and lines (including ABS)											
All fluid levels and condition of fluid	•	•	•	•	•	•	•	•	•	•	•
Exhaust system											
Fuel lines and connections											

Ukrainian models

Service at the indicated distance or time - whichever comes first.	km X 1,000	15	30	45	60	75	90	105	120	135	150	165	180	195
	months	12	24	36	48	60	72	84	96	108	120	132	144	156
Replace engine oil	When indicator comes on or 1 year													
Replace engine oil filter	When indicator comes on or 2 years													
Replace air cleaner element	Every 30,000 km													
Inspect valve clearance* ¹	Every 120,000 km													
Replace fuel filter* ³	Normal	Every 180,000 km												
	Severe	Every 105,000 km* ²												
Replace spark plugs	Every 120,000 km (Inspect: 15,000 km)													
Inspect drive belts	•	•	•	•	•	•	•	•	•	•	•	•	•	•
Replace engine coolant	At 200,000 km or 10 years, thereafter every 100,000 km or 5 years													

*1: Sensory method

Adjust the valves during services 120,000 km if they are noisy.

*2: It is recommended to replace the fuel filter if the fuel you are using is suspected to be contaminated with dust, etc. because the filter may be clogged sooner.

*3: Refer to page 693 for replacement information under driving conditions.

Service at the indicated distance or time - whichever comes first.	km X 1,000	15	30	45	60	75	90	105	120	135	150	165	180	195
	months	12	24	36	48	60	72	84	96	108	120	132	144	156
Replace transmission fluid	MT				•				•				•	
	CVT			•			•			•			•	
Replace rear differential fluid	AWD		•						•					
Inspect front and rear brakes		•	•	•	•	•	•	•	•	•	•	•	•	•
Replace brake fluid		Every 3 years												
Replace dust and pollen filter		•	•	•	•	•	•	•	•	•	•	•	•	•
Check lights alignment		•	•	•	•	•	•	•	•	•	•	•	•	•
Test drive (noise, stability, dashboard operation)		•	•	•	•	•	•	•	•	•	•	•	•	•
Rotate tyres (Check tyre inflation and condition at least once per month)		Every 15,000 km												
Visually inspect the following items:														
Tie rod ends, steering gearbox, and boots														
Suspension components														
Driveshaft boots														
Brake hoses and lines (including ABS)		•	•	•	•	•	•	•	•	•	•	•	•	•
All fluid levels and condition of fluid														
Exhaust system														
Fuel lines and connections														

If you drive your vehicle under severe conditions, you must have the following items served to the maintenance schedule indicated as Severe.

Items	Condition
Engine oil and filter	A, B, C, D and E
Transmission fluid	B and D

⌘ Maintenance Schedule*

The condition is considered as severe when you drive:

- A. Less than 8 km (5 miles), or less than 16 km (10 miles) in freezing temperatures per trip.
- B. In extremely hot temperature above 35°C.
- C. With extensive idling or long periods of stop-and-go.
- D. With a trailer towing, or loaded roof rack, or in mountains.
- E. On muddy, dusty or de-iced roads.

* Not available on all models

Maintenance Record (On Vehicles without Service Book)

Have your servicing dealer record all required maintenance below. Keep receipts for all work done on your vehicle.

Except European and Ukrainian models

Km or Month	Date	Sign or Stamp
20,000 km 12,500 Mi. (or 12 Mo.)		
40,000 km 25,000 Mi. (or 24 Mo.)		
60,000 km 37,500 Mi. (or 36 Mo.)		
80,000 km 50,000 Mi. (or 48 Mo.)		
100,000 km 62,500 Mi. (or 60 Mo.)		
120,000 km 75,000 Mi. (or 72 Mo.)		
140,000 km 87,500 Mi. (or 84 Mo.)		
160,000 km 100,000 Mi. (or 96 Mo.)		
180,000 km 112,500 Mi. (or 108 Mo.)		
200,000 km 125,000 Mi. (or 120 Mo.)		

Ukrainian models

	Km or Month	Date	Sign or Stamp
15,000 km (or 12 Mo.)			
30,000 km (or 24 Mo.)			
45,000 km (or 36 Mo.)			
60,000 km (or 48 Mo.)			
75,000 km (or 60 Mo.)			
90,000 km (or 72 Mo.)			
105,000 km (or 84 Mo.)			
120,000 km (or 96 Mo.)			
135,000 km (or 108 Mo.)			
150,000 km (or 120 Mo.)			
165,000 km (or 132 Mo.)			
180,000 km (or 144 Mo.)			
195,000 km (or 156 Mo.)			

Maintenance Items Under the Bonnet

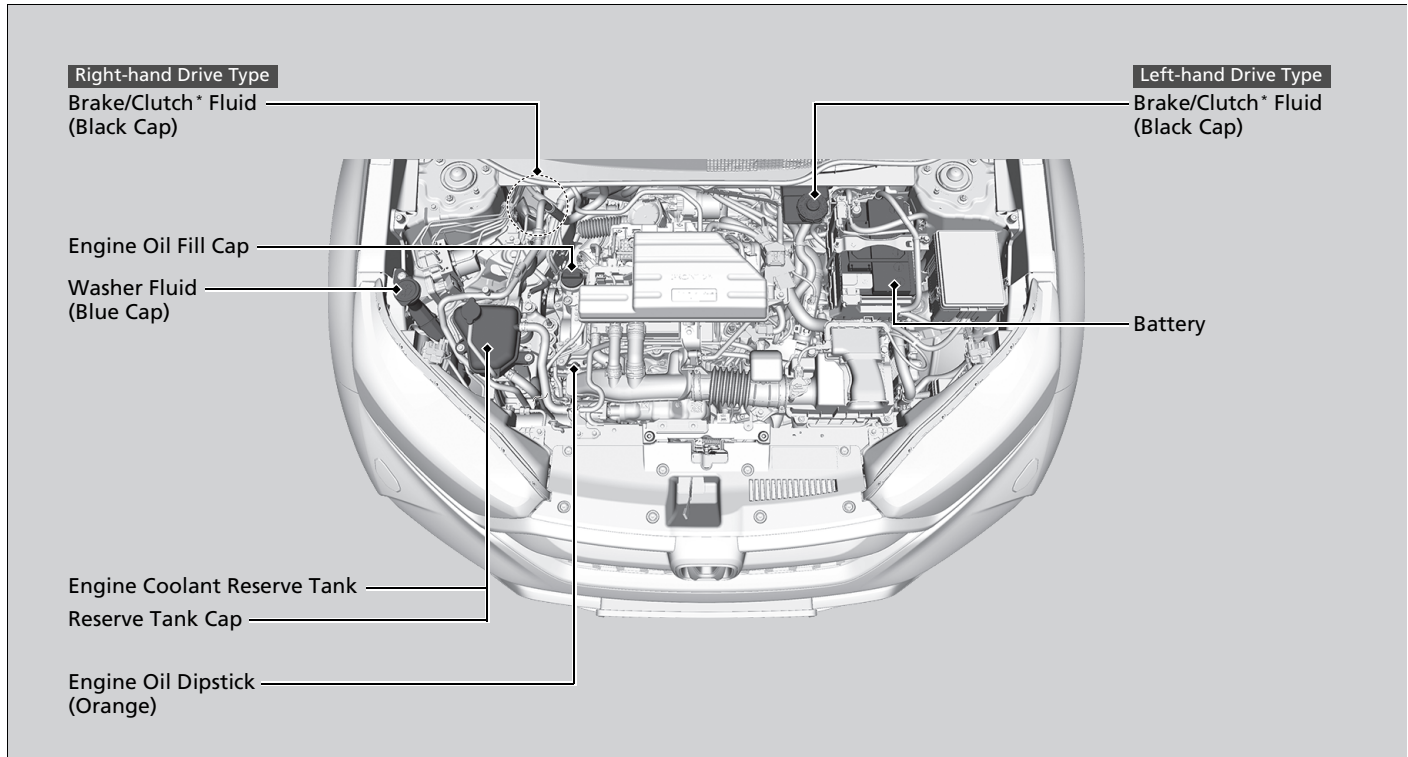

Opening the Bonnet

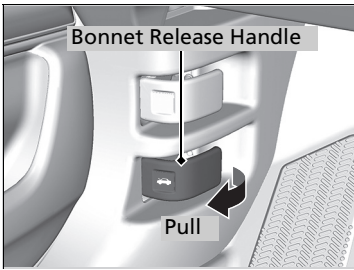

1. Park the vehicle on a level surface, and set the parking brake.
2. Pull the bonnet release handle under the driver's side lower outside corner of the dashboard.
 - ▶ The bonnet will pop up slightly.

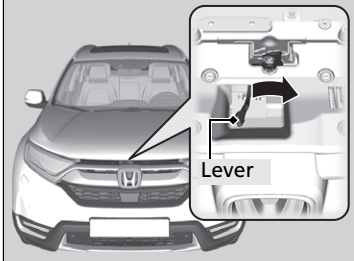

3. Push the bonnet latch lever (located under the front edge of the bonnet to the centre) to the side and raise the bonnet. Once you have raised the bonnet slightly, you can release the lever.

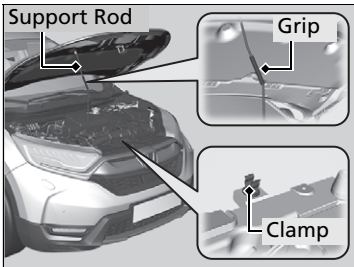

4. Remove the support rod from the clamp using the grip. Mount the support rod in the bonnet.

When closing, remove the support rod, and stow it in the clamp, then gently lower the bonnet. Remove your hand at a height of approximately 30 cm and let the bonnet close.

Opening the Bonnet

⚠ WARNING

The bonnet support rod can become very hot due to heat from the engine.

To ensure against possible burns, do not handle the metal section of the rod:
Use the foam grip instead.

NOTICE

Do not open the bonnet when the wiper arms are raised. The bonnet will strike the wipers, resulting in possible damage to the bonnet and/or the wipers.

When closing the bonnet, check that the bonnet is securely latched.

If the bonnet latch lever moves stiffly, or if you can open the bonnet without lifting the lever, the latch mechanism should be cleaned and lubricated.

Models with Auto Idle Stop

Do not open the bonnet while the Auto Idle Stop function is activated.

▶▶ Opening the Bonnet

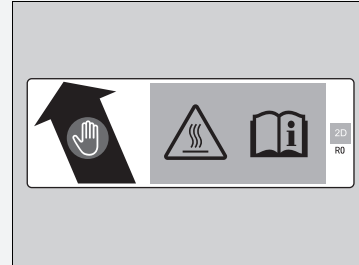

- Grab the foam.
- The support rod gets very hot.
- Refer to the owner's manual.

Recommended Engine Oil

Use a genuine engine oil or another commercial engine oil of suitable type and viscosity (for the ambient temperature) as shown in the image that follows.

Oil is a major contributor to your engine's performance and longevity. If you drive the vehicle with insufficient or deteriorated oil, the engine may fail or be damaged.

European and Ukrainian models

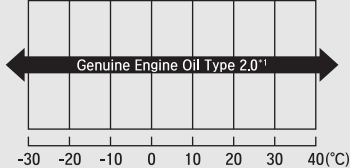
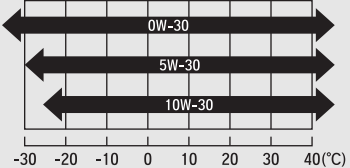
Genuine Engine Oil	Commercial Engine Oil
<ul style="list-style-type: none"> Genuine Honda Engine Oil Type 2.0*1 	<ul style="list-style-type: none"> ACEA C2/C3
 <p>A horizontal bar chart showing the temperature range for Genuine Engine Oil Type 2.0*1. The x-axis is labeled 'Ambient Temperature' and ranges from -30 to 40 degrees Celsius with major ticks every 10 units. A single double-headed arrow spans the entire range from -30 to 40.</p>	 <p>A horizontal bar chart showing the temperature ranges for three types of commercial engine oil. The x-axis is labeled 'Ambient Temperature' and ranges from -30 to 40 degrees Celsius with major ticks every 10 units. Three double-headed arrows are shown, each representing a different oil grade: 0W-30 (top), 5W-30 (middle), and 10W-30 (bottom). The 0W-30 arrow spans from approximately -35 to 40. The 5W-30 arrow spans from approximately -25 to 40. The 10W-30 arrow spans from approximately -15 to 40.</p>

* 1: Formulated to improve fuel economy.

Recommended Engine Oil

Engine Oil Additives

You cannot use Engine Oil Additives.

Except European and Ukrainian models

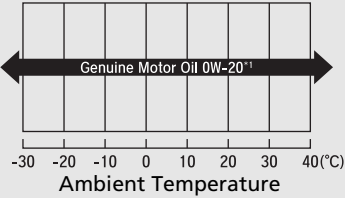
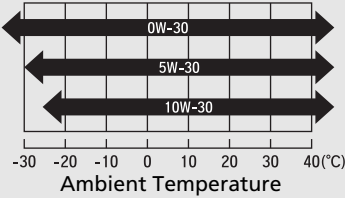
Genuine Engine Oil	Commercial Engine Oil
<ul style="list-style-type: none"> Genuine Honda Motor Oil*¹ 	<ul style="list-style-type: none"> ACEA C2/C3
 <p>A horizontal number line representing ambient temperature from -30 to 40°C. The line is divided into 11 equal segments by vertical tick marks at -30, -20, -10, 0, 10, 20, 30, and 40. A single thick black double-headed arrow spans the entire range from -30 to 40. The text 'Genuine Motor Oil 0W-20*1' is centered within the arrow.</p>	 <p>A horizontal number line representing ambient temperature from -30 to 40°C, identical to the one in the left column. Three thick black double-headed arrows are shown, each representing a different oil grade. The top arrow is labeled '0W-30' and spans from -30 to 40. The middle arrow is labeled '5W-30' and spans from -20 to 40. The bottom arrow is labeled '10W-30' and spans from -10 to 40.</p>

*1: Formulated to improve fuel economy.

Oil Check

We recommend that you check the engine oil level every time you refuel.

Park the vehicle on level ground.

Wait approximately three minutes after turning the engine off before you check the oil.

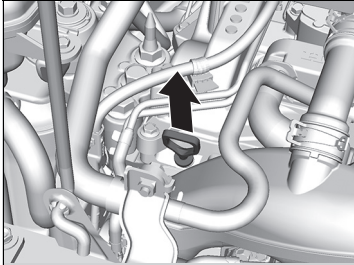

1. Remove the dipstick (orange).
2. Wipe the dipstick with a clean cloth or paper towel.
3. Insert the dipstick back all the way into its hole.

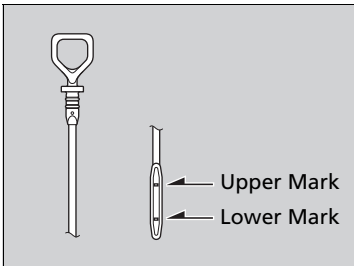

4. Remove the dipstick again, and check the level. It should be between the upper and lower marks. Add oil if necessary.

Oil Check

If the oil level is near or below the lower mark, slowly add oil, being careful not to overfill.

The amount of oil consumed depends on how the vehicle is driven and the climatic and road conditions encountered. The rate of oil consumption can be up to 1 litre per 1,000 km/625 miles. Consumption is likely to be higher when the engine is new.

Adding Engine Oil

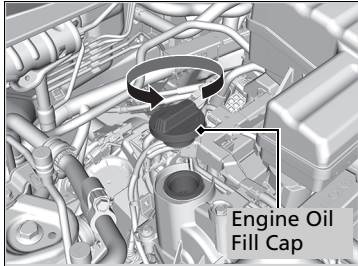

1. Unscrew and remove the engine oil fill cap.
2. Add oil slowly.
3. Reinstall the engine oil fill cap, and tighten it securely.
4. Wait for three minutes and recheck the engine oil dipstick.

▶▶ Adding Engine Oil

NOTICE

Do not fill the engine oil above the upper mark. Overfilling the engine oil can result in leaks and engine damage.

If any oil spills, wipe it away immediately. Spilled oil may damage the engine compartment components.

Engine Coolant

Specified coolant: Honda All Season Antifreeze/Coolant Type 2

This coolant is premixed with 50% antifreeze and 50% water. Do not add any straight antifreeze or water.

We recommend you check the engine coolant level every time you refuel. Check the reserve tank. Add the engine coolant accordingly.

Checking the Coolant

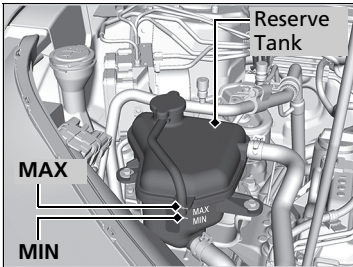

1. Make sure the engine and radiator are cool.
2. Check the amount of coolant in the reserve tank.
 - ▶ If the coolant level is below the **MIN** mark, add the specified coolant until it reaches the **MAX** mark.
3. Inspect the cooling system for leaks.

Engine Coolant

⚠ WARNING

Removing the reserve tank cap while the engine is hot can cause the coolant to spray out, seriously scalding you.

Always let the engine and radiator cool down before removing the reserve tank cap.

NOTICE

If temperatures consistently below -30°C are expected, the coolant mixture should be changed to a higher concentration. Consult your Honda dealer for details about a suitable coolant mixture.

If Honda antifreeze/coolant is not available, you may use another major brand of non-silicate coolant as a temporary replacement. Check that it is a high quality coolant recommended for aluminium engines. Continued use of any non-Honda coolant can result in corrosion, causing the cooling system to malfunction or fail. Have the cooling system flushed and refilled with Honda antifreeze/coolant as soon as possible.

Do not add rust inhibitors or other additives to your vehicle's cooling system. They may not be compatible with the coolant or with the engine components.

Continued

■ Adding the Coolant

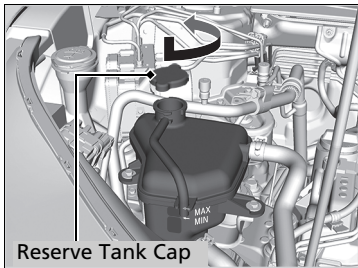

1. **Make sure the engine and radiator are cool.**
2. Turn the reserve tank cap 1/8 turn anti-clockwise and relieve any pressure in the cooling system.
3. Push down and turn the reserve tank cap anti-clockwise to remove it.
4. Pour coolant into the reserve tank until it reaches the **MAX** mark.
5. Put the reserve tank cap back on, and tighten it fully.

►► Adding the Coolant

NOTICE

Pour the fluid slowly and carefully so you do not spill any. Clean up any spills immediately; they can damage components in the engine compartment.

■ Engine Coolant Reserve Tank Cap



- Never open when hot.
- Hot coolant will scald you.
- Relief pressure valve begins to open at 108 kPa.

Transmission Fluid

■ Continuously Variable Transmission (CVT) Fluid

Specified fluid: Honda HCF-2 Transmission Fluid

Have a dealer check the fluid level and replace if necessary. Follow your vehicle's maintenance service timing of when to change continuously variable transmission fluid.

➤ **Maintenance Schedule*** P. 672

Do not attempt to check or change the continuously variable transmission fluid yourself.

■ Manual Transmission Fluid

Specified fluid: Honda Manual Transmission Fluid (MTF)

Have a dealer check the fluid level and replace if necessary. Follow your vehicle's maintenance service timing of when to change manual transmission fluid.

➤ **Maintenance Schedule*** P. 672

Do not attempt to check or change the manual transmission fluid yourself.

⌘ Continuously Variable Transmission (CVT) Fluid

NOTICE

Do not mix Honda HCF-2 with other transmission fluids.

Using a transmission fluid other than Honda HCF-2 may adversely affect the operation and durability of your vehicle's transmission, and damage the transmission.

Any damage caused by using a transmission fluid that is not equivalent to Honda HCF-2 is not covered by Honda's new vehicle limited warranty.

⌘ Manual Transmission Fluid

NOTICE

If Honda MTF is not available, you may use the API certificated SAE 0W-20 or 5W-20 viscosity motor oil as a temporary measure.

Replace with MTF as soon as possible. Motor oil does not contain the proper additives for the transmission and continued use can cause decreased shifting performance and lead to transmission damage.

Brake/Clutch* Fluid

Specified fluid: Brake Fluid with DOT 3 or DOT 4

Use the same fluid for both the brakes and clutch*.

Checking the Brake Fluid

Left-hand Drive Type

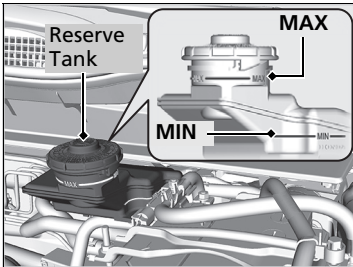

The fluid level should be between the **MIN** and **MAX** marks on the side of the reserve tank.

Manual transmission models

The brake fluid reserve tank is also used for your vehicle's clutch fluid. As long as you keep the brake fluid level as instructed above, there is no need for checking the clutch fluid level.

Right-hand Drive Type

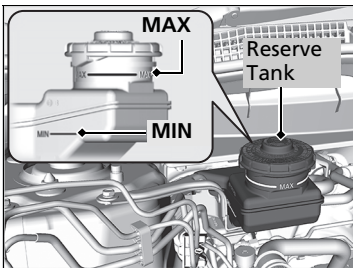

Brake/Clutch* Fluid

NOTICE

Brake fluid marked DOT 5 is not compatible with your vehicle's braking system and can cause extensive damage.

We recommend using a genuine product.

If the brake fluid level is at or below the **MIN** mark, have a dealer inspect the vehicle for leaks or worn brake pads as soon as possible.

* Not available on all models

Refilling Window Washer Fluid

Models with level gauge

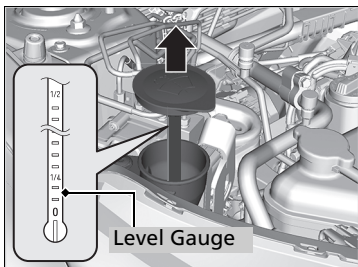

Check the amount of window washer fluid using the washer fluid level gauge on the cap.

If the level is low, fill the washer reservoir.

Models without level gauge

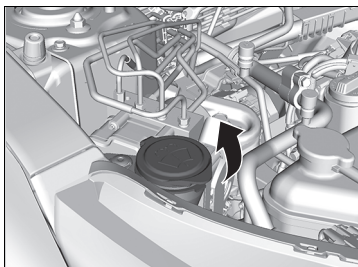

If the washer fluid is low, a symbol appears on the driver information interface.

All models

Pour the washer fluid carefully. Do not overflow the reservoir.

►► Refilling Window Washer Fluid

NOTICE

Do not use engine antifreeze or a vinegar/water solution in the windshield washer reservoir. Antifreeze can damage your vehicle's paint. A vinegar/water solution can damage the windshield washer pump. Use only commercially available windshield washer fluid. Avoid prolonged use of hard water to prevent lime scale build up.

Fuel Filter

Replace fuel filter according to the time and distance recommendations in the maintenance schedule.

Have a qualified technician change the fuel filter. Fuel in the system can spray out and create a hazard if all fuel line connections are not handled correctly.

⌘ Fuel Filter

Models with service reminder system

The fuel filter should be replaced according to the service reminder indication.

Headlights

Headlights are LED type. Have an authorised Honda dealer inspect and replace the light assembly.

▣ Headlights

The headlight aim is set by the factory, and does not need to be adjusted. However, if you regularly carry heavy items in the luggage area or tow a trailer, have the aiming readjusted at a dealer or by a qualified technician.

Front Fog Light Bulbs*

When replacing, use the following bulbs.

Front Fog Light: 35 W (H8 for halogen bulb type)*
Front Fog Light: LED type*

Models with halogen front fog lights

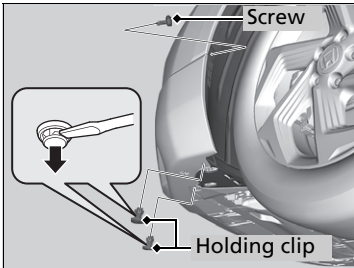

1. Remove the screw using a Phillips-head screwdriver and remove the holding clips using a flat-tip screwdriver.
2. Pull down the under cover.

Front Fog Light Bulbs*

Models with halogen front fog lights

NOTICE

Halogen bulbs get very hot when lit. Oil, perspiration, or a scratch on the glass can cause the bulb to overheat and shatter.

When replacing a halogen bulb, handle it by its plastic case, and protect the glass from contact with your skin or hard objects. If you touch the glass, clean it with denatured alcohol and a clean cloth.

Models with LED front fog lights

Front fog lights are LED type. Have an authorised Honda dealer inspect and replace the light assembly.

* Not available on all models

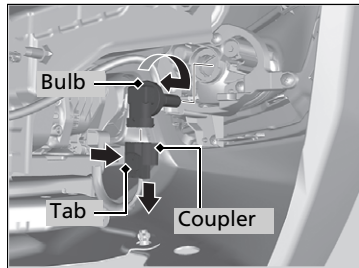

3. Push the tab to remove the coupler.

Right side

4. Rotate the old bulb to the right to remove.
5. Insert a new bulb into the fog light assembly and turn it to the left.
6. Insert the coupler into the connector of the bulb.

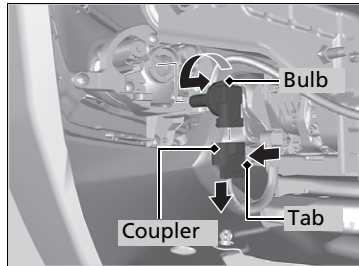

Left side

4. Rotate the old bulb to the left to remove.
5. Insert a new bulb into the fog light assembly and turn it to the right.
6. Insert the coupler into the connector of the bulb.

► Front Fog Light Bulbs*

Models with halogen front fog lights

Insert a flat-tip screwdriver, lift and remove the centre pin to remove the clip.

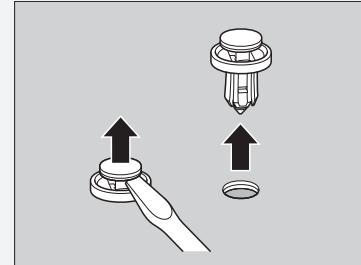

Insert the clip with the centre pin raised, and push until it is flat.

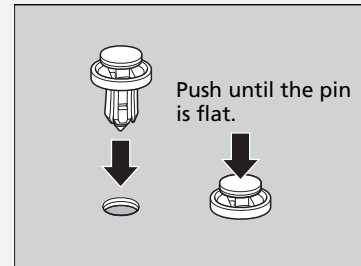

Position/Daytime Running Lights

Position/daytime running lights are LED type. Have an authorised Honda dealer inspect and replace the light assembly.

Active Cornering Lights*

Active cornering lights are LED type. Have an authorised Honda dealer inspect and replace the light assembly.

Front Turn Signal Lights

Front turn signal lights are LED type. Have an authorised Honda dealer inspect and replace the light assembly.

Side Turn Signal/Emergency Indicator Lights

Door mirror side turn lights are LED type. Have an authorised Honda dealer inspect and replace the light assembly.

Brake/Taillight and Rear Turn Signal Lights

Brake/taillight and rear turn signal lights are LED type. Have an authorised Honda dealer inspect and replace the light assembly.

* Not available on all models

Taillight and Back-Up Light Bulbs

When replacing, use the following bulbs.

Taillight: LED
Back-Up Light: 16 W

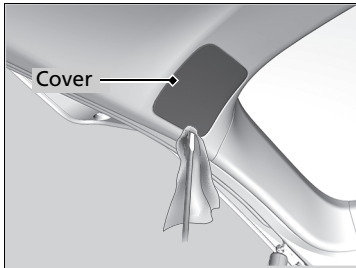

1. Remove the cover by prying on the edge using a flat-tip screwdriver.
 - ▶ Wrap the flat-tip screwdriver with a cloth to prevent scratches.

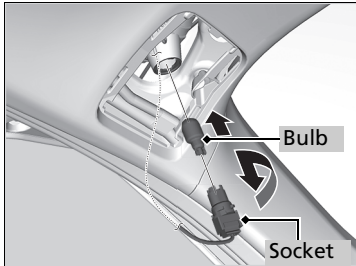

2. Turn the socket to the left and remove it. Remove the old bulb.
3. Insert a new bulb.

▶▶ Taillight and Back-Up Light Bulbs

Taillights are LED type. Have an authorised Honda dealer inspect and replace the light assembly.

Rear Licence Plate Light

Rear licence plate light is LED type. Have an authorised Honda dealer inspect and replace the light assembly.

High-Mount Brake Light

High-mount brake light is LED type. Have an authorised Honda dealer inspect and replace the light assembly.

Rear Fog Light

Rear fog light is LED type. Have an authorised Honda dealer inspect and replace the light assembly.

Other Light Bulbs

■ Vanity Mirror Light Bulbs*

When replacing, use the following bulbs.

Vanity Mirror Light: 2.0 W

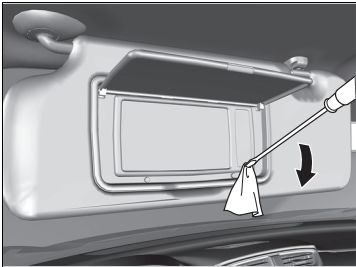

1. Pry on the edge of the cover using a flat-tip screwdriver to remove the cover.
 - Wrap the flat-tip screwdriver with a cloth to prevent scratches.

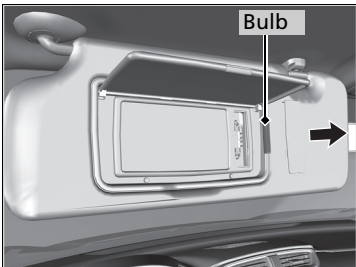

2. Remove the old bulb and insert a new bulb.

■ Luggage Area Light Bulb(s)

When replacing, use the following bulb.

Luggage Area Light: 5 W

Models with third row seat

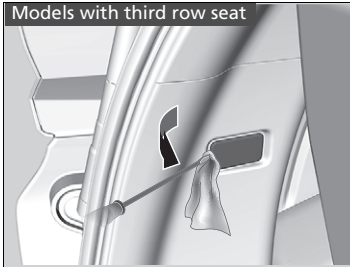

Models without third row seat

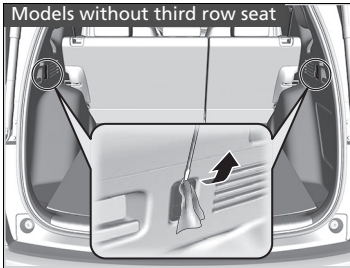

1. Pry on the edge of the cover using a flat-tip screwdriver to remove the cover.
 - Wrap the flat-tip screwdriver with a cloth to prevent scratches.

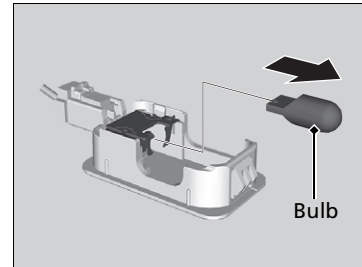

2. Remove the old bulb and insert a new bulb.

■ Glove Box Light Bulb*

When replacing, use the following bulb.

Glove Box Light: 3.4 W

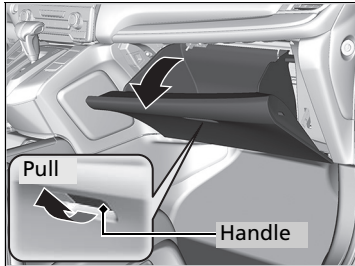

1. Open the glove box.

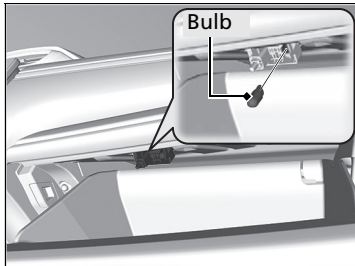

2. Remove the old bulb and insert a new bulb.

* Not available on all models

Checking Wiper Blades

If the wiper blade rubber has deteriorated, it will leave streaks and the hard surfaces of the blade may scratch the window glass.

Changing the Front Wiper Blade Rubber

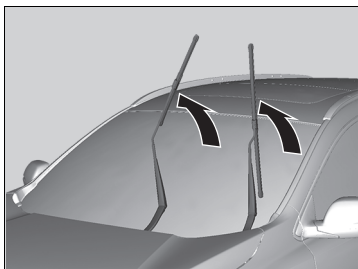
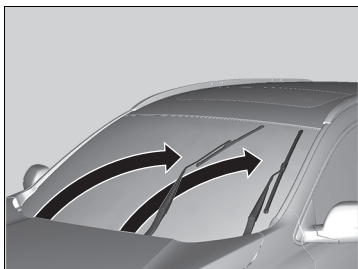

1. Turn the ignition switch to LOCK **0***1.
2. While holding the wiper switch in the **MIST** position, turn the ignition switch to ON **II***1, then to LOCK **0***1.
 - ▶ Both wiper arms are set to the maintenance position as shown in the image.
3. Lift both wiper arms.

Changing the Front Wiper Blade Rubber

NOTICE

Avoid dropping the wiper arm onto the windshield, it may damage the wiper arm and/or the windshield.

*1: Models with the keyless access system have an **ENGINE START/STOP** button instead of an ignition switch.

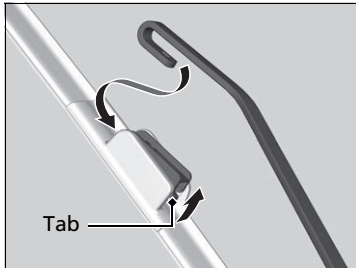

4. Press and hold the tab, then slide the holder off the wiper arm.

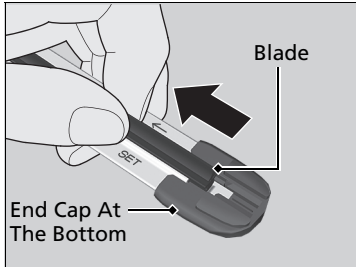

5. Pull the end of the wiper blade in the direction of the arrow in the image until it is out of the holder's end cap.

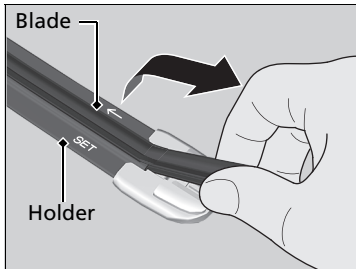

6. Pull the wiper blade in the opposite direction to slide it out of the holder.

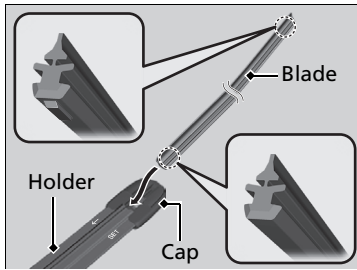

7. Insert the flat side of the new wiper blade onto the bottom part of the holder. Insert the blade all the way.
8. Install the end of the wiper blade into the cap.
9. Slide the holder onto the wiper arm until it locks.
10. Lower both wiper arms.
11. Turn the ignition switch to ON *1 and hold the wiper switch in the **MIST** position until both wiper arms return to the standard position.

*1: Models with the keyless access system have an **ENGINE START/STOP** button instead of an ignition switch.

Changing the Rear Wiper Blade Rubber

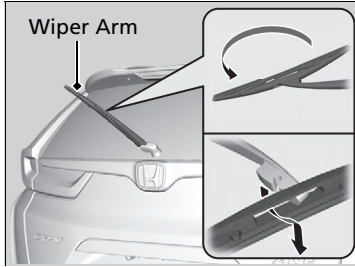

1. Raise the wiper arm off.
2. Pivot the bottom end of the wiper blade up until it comes off from the wiper arm.

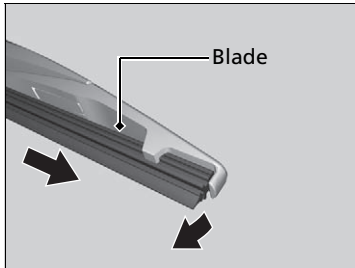

3. Slide the blade out of the wiper.

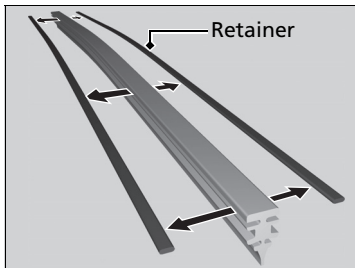

4. Remove the retainers from wiper blade and mount to a new rubber blade.

Changing the Rear Wiper Blade Rubber

NOTICE

Avoid dropping the wiper arm; it may damage the rear window.

Continued

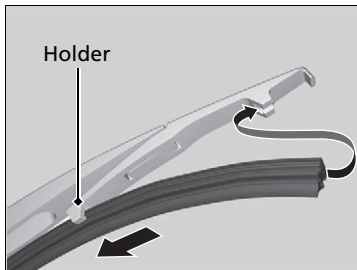

5. Slide the new wiper blade onto the holder.
 - ▶ Make sure it is engaged correctly, then install the wiper blade assembly onto the wiper arm.

Checking Tyres

To safely operate your vehicle, your tyres must be of the proper type and size, in good condition with adequate tread, and properly inflated.

■ Inflation guidelines

Properly inflated tyres provide the best combination of handling, tread life, and comfort. Refer to the driver's doorjamb label for the specified pressure.

Underinflated tyres wear unevenly, adversely affect handling and fuel economy, and are more likely to fail from overheating.

Overinflated tyres make your vehicle ride harshly, are more prone to road hazards, and wear unevenly.

Every day before you drive, look at each of the tyres. If one looks lower than the others, check the pressure with a tyre gauge.

At least once a month or before long trips, use a gauge to measure the pressure in all tyres, including the spare. Even tyres in good condition can lose 10–20 kPa (0.1–0.2 bar, 1–2 psi) per month.

■ Inspection guidelines

Every time you check inflation, also examine the tyres and valve stems.

Look for:

- Bumps or bulges on the side or in the tread. Replace the tyre if you find any cuts, splits, or cracks in the side of the tyre. Replace it if you see fabric or cord.
- Remove any foreign objects and inspect for air leaks.
- Uneven tread wear. Have a dealer check the wheel alignment.
- Excessive tread wear.

➤ **Wear Indicators** P. 708

- Cracks or other damage around valve stem.

☒ Checking Tyres

⚠ WARNING

Using tyres that are excessively worn or improperly inflated can cause a crash in which you can be seriously hurt or killed.

Follow all instructions in this owner's manual regarding tyre inflation and maintenance.

Measure the air pressure when tyres are cold. This means the vehicle has been parked for at least three hours, or driven less than 1.6 km (1 mile). If necessary, add or release air until the specified pressure is reached.

If checked when hot, tyre pressure can be as much as 30–40 kPa (0.3–0.4 bar, 4–6 psi) higher than if checked when cold.

Whenever tyre pressure is adjusted, you must initialise the deflation warning system.

➤ **Deflation Warning System** P. 551

Wear Indicators

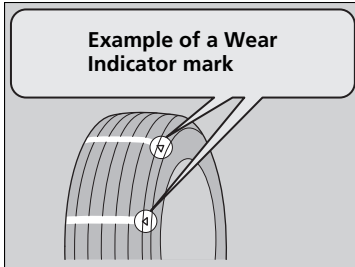

The groove where the wear indicator is located is 1.6 mm (1/16 inch) shallower than elsewhere on the tyre. If the tread has worn so that the indicator is exposed, replace the tyre.

Worn out tyres have poor traction on wet roads.

Tyre Service Life

The life of your tyres is dependent on many factors, including driving habits, road conditions, vehicle loading, inflation pressure, maintenance history, speed, and environmental conditions (even when the tyres are not in use).

In addition to regular inspections and inflation pressure maintenance, it is recommended that you have annual inspections performed once the tyres reach five years old. All tyres, including the spare, should be removed from service after 10 years from the date of manufacture, regardless of their condition or state of wear.

☒ Checking Tyres

Have a dealer check the tyres if you feel a consistent vibration while driving. New tyres and any that have been removed and reinstalled should be properly balanced.

Tyre and Wheel Replacement

Replace your tyres with radials of the same size, load range, speed rating, and maximum cold tyre pressure rating (as shown on the tyre's sidewall). Using tyres of a different size or construction can cause certain vehicle systems such as the ABS and Vehicle Stability Assist (VSA) system to work incorrectly.

It is best to replace all four tyres at the same time. If that isn't possible, replace the front or rear tyres in pairs.

Make sure that the wheel's specifications match those of the original wheels.

⚠ Tyre and Wheel Replacement

⚠ WARNING

Installing improper tyres on your vehicle can affect handling and stability. This can cause a crash in which you can be seriously hurt or killed.

Always use the size and type of tyres recommended in the tyre information label on your vehicle.

Tyre Rotation

Rotating tyres according to the maintenance schedule helps to distribute wear more evenly and increase tyre life.

■ Tyres without rotation marks

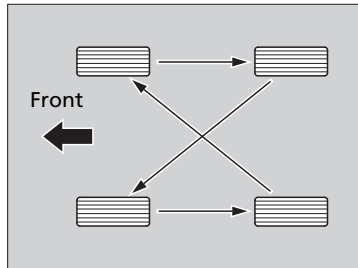

Rotate the tyres as shown here.

■ Tyres with rotation marks

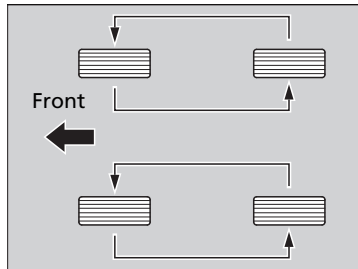

Rotate the tyres as shown here.

▣ Tyre Rotation

Tyres with directional tread patterns should only be rotated front to back (not from one side to the other). Directional tyres should be mounted with the rotation indication mark facing forward, as shown below.

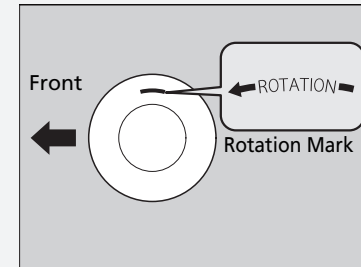

When the tyres are rotated, make sure the air pressures are checked.

Whenever tyres are rotated, you must initialise the deflation warning system.

▣ **Deflation Warning System** P. 551

Snow Traction Devices

If driving on snowy or frozen roads, mount winter tyres, or tyre chains; reduce speed; and maintain sufficient distance between vehicles when driving.

Be particularly careful when operating the steering wheel or brakes to prevent skidding.

Use tyre chains, winter tyres, or all season tyres when necessary or according to the law.

When mounting, refer to the following points.

For winter tyres:

- Select the size and load ranges that are the same as the original tyres.
- Mount the tyres to all four wheels.

For tyre chains:

- Consult a dealer before purchasing any type of chains for your vehicle.
- Install them on the front tyres only.
- Because your vehicle has limited tyre clearance, we strongly recommend using the chains listed below:

Original Tyre Size*1	Chain Type
235/65R17 104H	RUD-matic classic 4716134
235/60R18 103H	RUD-matic classic 4716134
235/55R19 101Y	RUD-matic classic V 19642

*1: Original tyre size is mentioned on the tyre information label on the driver's doorjamb.

- Follow the chain manufacturer's instruction when installing. Mount them as tightly as you can.
- Check that the chains do not touch the brake lines or suspension.
- Drive slowly.

⚠ Snow Traction Devices

⚠ WARNING

Using the wrong chains, or not properly installing chains, can damage the brake lines and cause a crash in which you can be seriously injured or killed.

Follow all instructions in this owner's manual regarding the selection and use of tyre chains.

NOTICE

Traction devices that are the wrong size or improperly installed can damage your vehicle's brake lines, suspension, body, and wheels. Stop driving if they are hitting any part of the vehicle.

According to the EEC Directive for tyres, when winter tyres are used, it is necessary to affix a sticker with the allowable max. speed of the winter tyres clearly in the field of view of the driver, if the designed max. speed of vehicle is higher than the allowed max. speed of winter tyre. A sticker is obtainable from your tyre dealer. If you have any question, consult a dealer.

When tyre chains are mounted, follow the chain manufacturer's instructions regarding vehicle operational limits.

Use tyre chains only in an emergency or when they are legally required for driving through a certain area.

Use greater caution when driving with tyre chains on snow or ice. They may have less-predictable handling than good winter tyres without chains.

If your vehicle is equipped with summer tyres, be aware that these tyres are not designed for winter driving conditions. For more information, contact a dealer.

Checking the Battery

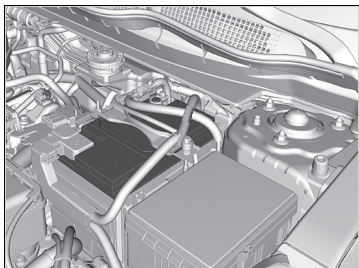

The condition of the battery is monitored by a sensor located on the negative terminal of the battery. If there is a problem with this sensor, the driver information interface will display a warning message. If this happens, have your vehicle inspected by a dealer.

Check the battery terminals for corrosion monthly.

If your vehicle's battery is disconnected or goes dead:

- The audio system is disabled.
 - **Reactivating the audio system** P. 301
- The clock resets.
 - **Clock** P. 176
- The immobilizer system needs to be reset.
 - **Immobilizer System Indicator** P. 110

Battery

⚠ WARNING

The battery gives off explosive hydrogen gas during normal operation.

A spark or open flame can cause the battery to explode with enough force to kill or seriously hurt you.

Keep all sparks, open flames, and smoking materials away from the battery.

Wear protective clothing and a face shield, or have a skilled technician do any battery maintenance.

⚠ WARNING

The battery contains sulfuric acid (electrolyte) which is highly corrosive and poisonous.

Getting electrolyte in your eyes or on your skin can cause serious burns. Wear protective clothing and eye protection when working on or near the battery.

Swallowing electrolyte can cause fatal poisoning if immediate action is not taken.

KEEP OUT OF THE REACH OF CHILDREN

▶▶ Battery

Emergency Procedures

Eyes: Flush with water from a cup or other container for at least 15 minutes. (Water under pressure can damage the eye.) Call a physician immediately.

Skin: Remove contaminated clothing. Flush the skin with large quantities of water. Call a physician immediately.

Swallowing: Drink water or milk. Call a physician immediately.

When you find corrosion, clean the battery terminals by applying a baking powder and water solution.

Clean the terminals with a damp towel. Cloth/towel dry the battery. Coat the terminals with grease to help prevent future corrosion.

When replacing the battery, the replacement must be of the same specifications.

Consult a dealer for more information.

Charging the Battery

Disconnect both battery cables to prevent damaging your vehicle's electrical system. Always disconnect the negative (-) cable first, and reconnect it last.

▶▶ Battery

Models with Auto Idle Stop

The battery installed in this vehicle is specifically designed for a model with Auto Idle Stop. Using a battery other than this specified type may shorten the battery life, and prevent Auto Idle Stop from activating. If you need to replace the battery, make sure to select the specified type. Ask a dealer for more details.

The indicators for the Adaptive Cruise Control (ACC)*, Adaptive Cruise Control (ACC) with Low Speed Follow (LSF)*, Road Departure Mitigation, Vehicle Stability Assist (VSA) system, VSA OFF, Collision Mitigation Braking System (CMBS), Low Tyre Pressure/Deflation Warning System, and Parking Brake and Brake System (Amber) may come on along with a message in the Driver Information Interface when you turn the ignition switch to ON **II***¹ after reconnecting the battery.

Drive a short distance at more than 20 km/h (12 mph). The indicator should go off. If it does not, have your vehicle checked by a dealer.

*1: Models with the keyless access system have an **ENGINE START/STOP** button instead of an ignition switch.

* Not available on all models

Replacing the Battery

When you remove and replace the battery, always follow the maintenance safety and the warnings for when checking the battery to prevent potential hazards.

🔧 **Maintenance Safety** P. 659

🔧 **Checking the Battery** P. 712

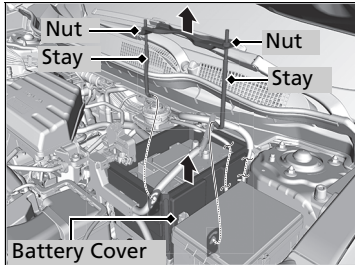
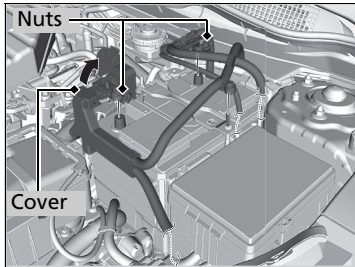

1. Turn the ignition switch to LOCK *1. Open the bonnet.
2. Loosen the nut on the negative battery cable, then disconnect the cable from the negative (-) terminal.
3. Open the positive battery terminal cover. Loosen the nut on the positive battery cable, then disconnect the cable from the positive (+) terminal.
4. Loosen the nut on each side of the battery bracket with a wrench.
5. Pull the bottom end of each battery stay out of the hole on the battery base, and remove the combination of the battery bracket and the stays.
6. Remove the battery cover.

*1: Models with the keyless access system have an **ENGINE START/STOP** button instead of an ignition switch.

▶▶ Replacing the Battery

NOTICE

An improperly disposed of battery can be harmful to the environment and human health. Always confirm local regulations for battery disposal.

This symbol on the battery means that this product must not be treated as household waste.



To install a new battery, reverse this procedure.

Always disconnect the negative (-) cable first, and reconnect it last.

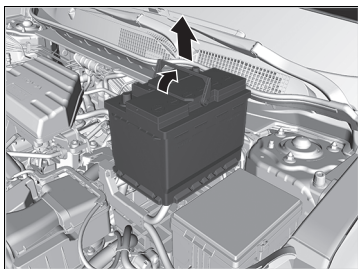

7. Take out the battery carefully.

Battery Label



Example

⌘ Battery Label

DANGER

- Keep flames and sparks away from the battery. The battery produces explosive gas that can cause an explosion.
- Wear eye protection and rubber gloves when handling the battery to avoid risk of burns or loss of eyesight if exposed to battery electrolyte.
- Do not allow children to handle the battery, under any circumstance. Ensure that anyone handling the battery has a proper understanding of the hazards and correct handling procedures involved.
- Handle battery electrolyte with extreme care, as it contains dilute sulfuric acid. Exposure to eyes or skin can cause burns or loss of eyesight.
- Read this manual carefully, and understand it before handling the battery. Failure to do so can cause personal injury and damage to the vehicle.
- Do not use the battery if the level of electrolyte is at or below the recommended level. Using the battery with low electrolyte can cause it to explode, causing serious injury.

Replacing the Button Battery

If the indicator does not come on when the button is pressed, replace the battery.

▶▶ Replacing the Button Battery

■ Retractable Key*

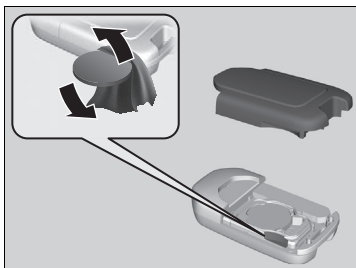

Battery type: CR2032

1. Remove the upper half of the cover by carefully prying on the edge with a coin.
▶ Wrap a coin with a cloth to prevent scratching the retractable key.
2. Remove the button battery with the small flat-tip screwdriver.
3. Make sure to replace the battery with the correct polarity.

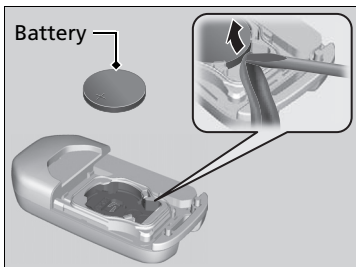

⚠ ⚠ WARNING

CHEMICAL BURN HAZARD

The battery that powers the remote transmitter can cause severe internal burns and can even lead to death if swallowed. Keep new and used batteries away from children. If you suspect that a child has swallowed the battery, seek medical attention immediately.

A warning mark is located adjacent to the button battery*.

NOTICE

An improperly disposed of battery can damage the environment. Always confirm local regulations for battery disposal.

This symbol on the battery means that this product must not be treated as household waste.



Replacement batteries are commercially available or at a dealer.

■ Keyless Remote *

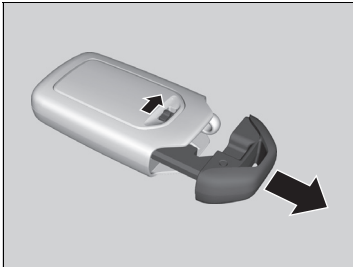

Battery type: CR2032

1. Remove the built-in key.

2. Remove the upper half by carefully prying on the edge with a coin.
 - ▶ Remove carefully to avoid losing the buttons.
 - ▶ Wrap a coin with a cloth to prevent scratching the keyless remote.

3. Make sure to replace the battery with the correct polarity.

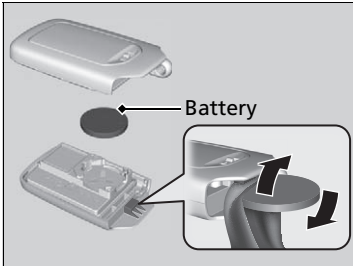

* Not available on all models

Air Conditioning

For proper and safe operation of the climate control system, the refrigerant system should only be served by a qualified technician.

Never repair or replace the air conditioning evaporator (cooling coil) with one removed from a used or salvaged vehicle.

Climate Control System Maintenance

NOTICE

Vented refrigerant is harmful to the environment. To avoid refrigerant from venting, never replace the evaporator with one removed from a used or salvaged vehicle.

Refrigerant in your vehicle's air conditioning system is flammable and can be ignited during servicing if proper procedures are not followed.

The air conditioner label is found under the bonnet:

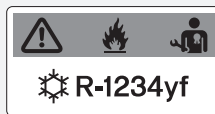

 : Caution

 : Flammable Refrigerant

 : Requires Registered Technician to Service

 : Air Conditioning System

 **Safety Labels** P. 95

 **Specifications** P. 770

Dust and Pollen Filter

■ When to Replace the Dust and Pollen Filter

Replace the dust and pollen filter according to your vehicle's recommended maintenance schedule. It is recommended to replace the filter even sooner if the vehicle has been driven in a dusty environment.

📖 **Maintenance Schedule*** P. 672

■ How to Replace the Dust and Pollen Filter

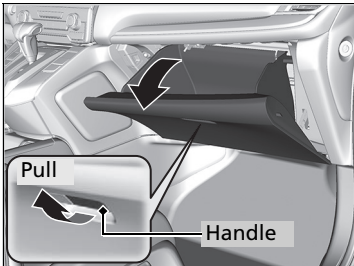

1. Open the glove box.

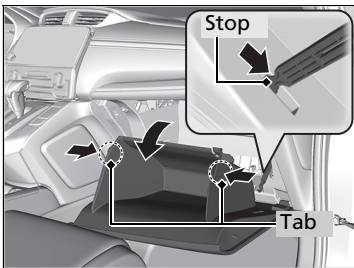

2. Disengage the two tabs by pushing on each side panel, then push down the stop.

3. Pivot the glove box out of the way.

📖 Dust and Pollen Filter

If the airflow from the climate control system deteriorates noticeably, and the windows fog up easily, the filter may need to be replaced.

The dust and pollen filter collects pollen, dust, and other debris in the air.

If you are not sure how to replace the dust and pollen filter, have it replaced by a dealer.

* Not available on all models

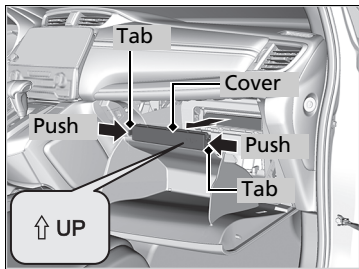

4. Push in the tabs on the corners of the filter case cover, and remove it.

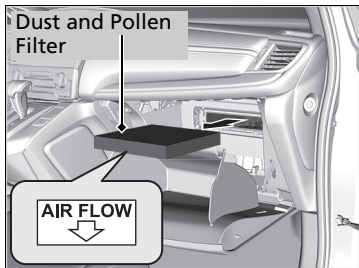

5. Remove the filter from the case.

6. Install a new filter in the case.

► Put the **AIR FLOW** arrow directed side down.

Interior Care

Use a vacuum cleaner to remove dust before using a cloth.

Use a damp cloth with a mixture of mild detergent and warm water to remove dirt.

Use a clean cloth to remove detergent residue.

■ Cleaning Seat Belts

Use a soft brush with a mixture of mild soap and warm water to clean the seat belts.

Let the belts air dry. Wipe the loops of the seat belt anchors using a clean cloth.

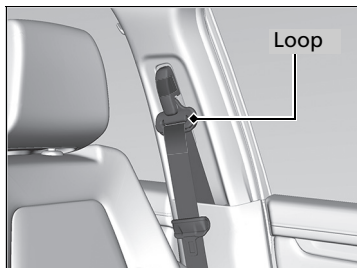

▣ Interior Care

Do not spill liquids inside the vehicle. Electrical devices and systems may malfunction if liquids are splashed on them.

Do not use silicone based sprays on electrical devices such as audio devices and switches. Doing so may cause the items to malfunction or cause a fire inside the vehicle.

If a silicone based spray is inadvertently used on electrical devices, consult a dealer.

Depending on their composition, chemicals and liquid aromatics may cause discolouration, wrinkles, and cracking to resin-based parts and textiles. Do not use alkali solvents or organic solvents such as benzene or petrol.

After using chemicals, make sure to gently wipe them away using a dry cloth.

Do not place used cloths on top of resin based parts or textiles for long periods of time without washing.

Be careful not to spill a liquid type air freshener.

■ Cleaning the Window

Wipe using a glass cleaner.

■ Maintaining Genuine Leather*

To properly clean leather:

1. Use a vacuum or soft dry cloth first to remove any dirt or dust.
2. Clean the leather with a soft cloth dampened with a solution comprised of 90% water and 10% neutral soap.
3. Wipe away any soap residue with a clean damp cloth.
4. Wipe away residual water and allow leather to air dry in the shade.

✎ Cleaning the Window

Wires are mounted to the inside of the rear window. Wipe along the same direction as the wires with a soft cloth so as not to damage them.

Be careful not to spill fluids, such as water or glass cleaner, on or around the cover of both the front sensor camera and the rainfall/light sensor*.

✎ Maintaining Genuine Leather*

It is important to clean or wipe away dirt or dust as soon as possible. Spills can soak into leather resulting in stains. Dirt or dust can cause abrasions in the leather. In addition, please note that some dark coloured clothing can rub onto the leather seats resulting in discolouration or stains.

Exterior Care

Dust off the vehicle body after you drive. Regularly inspect your vehicle for scratches on painted surfaces. A scratch on a painted surface can result in body rust. If you find a scratch, promptly repair it.

Washing the Vehicle

Wash the vehicle regularly. Wash more frequently when driving in the following conditions:

- If driving on roads with road salt.
- If driving in coastal areas.
- If tar, soot, bird droppings, insects, or tree sap are stuck to painted surfaces.

Using an Automated Car Wash

- Make sure to follow the instructions indicated on the automated car wash.
- Fold in the door mirrors.
- Turn off the automatic intermittent wipers*.

Using High Pressure Cleaners

- Keep sufficient distance between the cleaning nozzle and the vehicle body.
- Take particular care around the windows. Standing too close may cause water to enter the vehicle interior.
- Do not spray high pressure water directly into the engine compartment. Instead, use low pressure water and a mild detergent.

* Not available on all models

Continued

Washing the Vehicle

Do not spray water into the air intake vents. It can cause a malfunction.

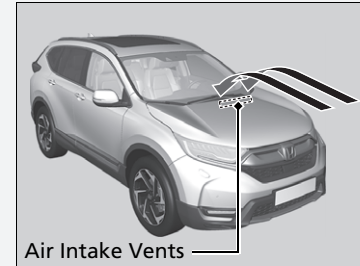

If you need to lift the wiper arms away from the windshield, first set the wiper arms to the maintenance position.

▶ **Changing the Front Wiper Blade Rubber**
P. 702

■ Applying Wax

A good coat of automotive body wax helps to protect your vehicle's paint from the elements. Wax will wear off over time and expose your vehicle's paint to the elements, so reapply as necessary.

■ Maintaining the Bumpers and Other Resin Coated Parts

If you get petrol, oil, engine coolant, or battery fluid on resin coated parts, they may be stained or the coating may peel. Promptly wipe it away using a soft cloth and clean water.

■ Cleaning the Window

Wipe using a glass cleaner.

▣ Applying Wax

NOTICE

Chemical solvents and strong cleaners can damage the paint, metal, and plastic on your vehicle. Wipe away spills immediately.

▣ Maintaining the Bumpers and Other Resin Coated Parts

Ask a dealer about the correct coating material when you want to repair the painted surface of the parts made of resin.

■ Maintaining Aluminium Wheels

Aluminium is susceptible to deterioration caused by salt and other road contaminants. When necessary, as early as possible use a sponge and mild detergent to wipe away these contaminants. Do not use a stiff brush or harsh chemicals (including some commercial wheel cleaners). These can damage the protective finish on aluminium alloy wheels, resulting in corrosion. Depending on the type of finish, the wheels also may lose their lustre or appear burnished. To avoid water stains, wipe the wheels dry with a cloth while they are still wet.

■ Fogged Exterior Light Lenses

The inside lenses of exterior lights (headlights, brake lights, etc.) may fog temporarily if you have driven in the rain, or after the vehicle has been run through a car wash. Dew condensation also may build up inside the lenses when there is a significant enough difference between the ambient and inside lens temperatures (similar to vehicle windows fogging up in rainy conditions). These conditions are natural processes, not structural design problems in the exterior lights. Lens design characteristics may result in moisture developing on the light lens frame surfaces. This also is not a malfunction. However, if you see large amounts of water accumulation, or large water drops building up inside the lenses, have your vehicle inspected by a dealer.

Accessories

When installing accessories, check the following:

- Do not install accessories on the windshield. They can obstruct your view and delay your reaction to driving conditions.
- Do not install any accessories over areas marked SRS Airbag, on the sides or backs of the front seats, on front or side pillars, or near the side windows. Accessories installed in these areas may interfere with proper operation of the vehicle's airbags or may be propelled into you or another occupant if the airbags deploy.
- Be sure electronic accessories do not overload electrical circuits or interfere with proper operation of your vehicle.
 - **Fuses** P. 758
- Before installing any electronic accessory, have the installer contact a dealer for assistance. If possible, have a dealer inspect the final installation.

Accessories and Modifications

WARNING

Improper accessories or modifications can affect your vehicle's handling, stability, and performance, and cause a crash in which you can be seriously hurt or killed.

Follow all instructions in this owner's manual regarding accessories and modifications.

When properly installed, mobile phones, alarms, two-way radios, radio antennas, and low-powered audio systems should not interfere with your vehicle's computer controlled systems, such as your airbags and anti-lock brakes.

Honda Genuine accessories are recommended to ensure proper operation on your vehicle.

Modifications

Do not modify your vehicle in a manner that may affect its handling, stability, or reliability, or install non-genuine Honda parts or accessories that may have a similar effect.

Even minor modifications to vehicle systems can affect overall vehicle performance. Always make sure all equipment is properly installed and maintained, and do not make any modification to your vehicle or its systems that might cause your vehicle to no longer meet your country's and local regulations.

The on-board diagnostic port (OBD-II/SAE J1962 connector) installed on this vehicle is intended to be used with automobile system diagnostic devices or with other devices that Honda has approved. Use of any other type of device may adversely affect the vehicle's electronic systems or allow them to be compromised, possibly resulting in a system malfunction, drained battery, or other unexpected problems.

Do not modify or attempt to repair any of the electrical components.

Handling the Unexpected

This chapter explains how to handle unexpected troubles.



Tools

Types of Tools..... 732

If a Tyre Goes Flat

Changing a Flat Tyre 734

Engine Does Not Start

Checking the Engine 743

Models with keyless access system

If the Keyless Remote Battery is Weak.. 744

Models with keyless access system

Emergency Engine Stop 745

Jump Starting 746

Shift Lever Does Not Move* 748

Overheating

How to Handle Overheating..... 749

Indicator, Coming On/Blinking

If the Low Oil Pressure Indicator Comes

On 751

If the Charging System Indicator Comes

On 751

If the Malfunction Indicator Lamp Comes

On or Blinks 752

If the Brake System Indicator (Red) Comes

On or Blinks 753

If the Brake System Indicator (Red) Comes On

or Blinks at the Same Time When the Brake

System Indicator (Amber) Comes On.. 754

If the Electric Power Steering (EPS) System

Indicator Comes On 755

If the Low Tyre Pressure/Deflation Warning

System Indicator Comes On or Blinks..... 756

If the Low Oil Level Symbol Appears..... 757

Fuses

Fuse Locations 758

Inspecting and Changing Fuses..... 764

Emergency Towing..... 765

When You Cannot Open the Tailgate..... 766

* Not available on all models

Types of Tools

Models without third row seat

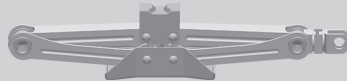
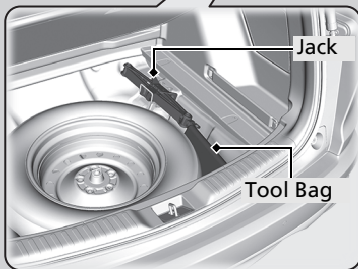

Jack

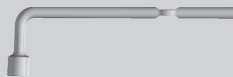

Wheel Nut Wrench/
Jack Handle

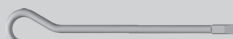

Jack Handle Bar



Grip



Screwdriver

Types of Tools

The tools are stored in the luggage area.

Models with third row seat

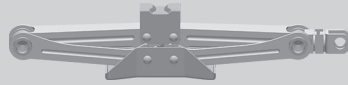
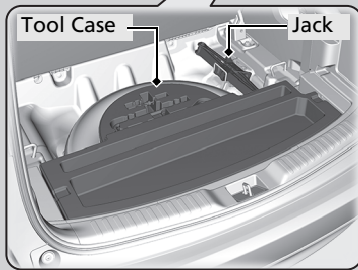

Jack

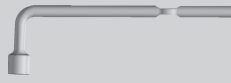

Wheel Nut Wrench/
Jack Handle

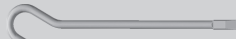

Jack Handle Bar



Grip



Screwdriver

Changing a Flat Tyre

If a tyre goes flat while driving, grasp the steering wheel firmly, and brake gradually to reduce speed. Then stop in a safe place. Replace the flat tyre with a compact spare tyre. Go to a dealer as soon as possible to have the full-size tyre repaired or replaced.

1. Park the vehicle on firm, level, and non-slippery surface, and apply the parking brake.

Continuously variable transmission models

2. Move the shift lever to **P**.

Manual transmission models

2. Move the shift lever to **R**.

All models

3. Set the parking brake.
4. Turn on the hazard warning lights and turn the ignition switch to LOCK **0***1.

*1: Models with the keyless access system have an **ENGINE START/STOP** button instead of an ignition switch.

Changing a Flat Tyre

Follow compact spare precautions:
Periodically check the tyre pressure of the compact spare. It should be set to the specified pressure.
Specified Pressure: 420 kPa (4.2 bar, 60 psi)

When driving with the compact spare tyre, keep the vehicle speed under 80 km/h (50 mph). Replace with a full-size tyre as soon as possible.

The compact spare tyre and wheel in your vehicle are specifically for this model. Do not use them with another vehicle. Do not use another type of compact spare tyre or wheel with your vehicle.

Do not mount tyre chains on a compact spare tyre. If a chain-mounted front tyre goes flat, remove one of the full-size rear tyres and replace it with the compact spare tyre. Remove the flat front tyre and replace it with the full-size tyre that was removed from the rear.
Mount the tyre chains on the front tyre.

A compact spare tyre gives a harsher ride and less traction on some road surfaces. Use greater caution while driving.

Do not use more than one compact spare tyre at the same time.

The compact spare tyre is smaller than the regular tyre. Your vehicle's ground clearance reduces when the compact spare tyre is installed. Driving over road debris or bumps could possibly damage the underside of your vehicle.

Getting Ready to Replace the Flat Tyre

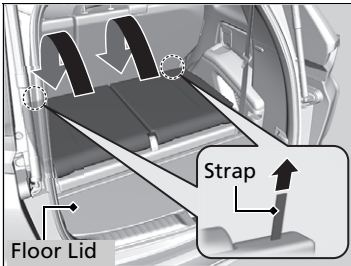

Models with third row seat

1. Lower the third row seat head restraint to its lowest position.
Unlock the seat-back by pulling the strap. Push the seat-back forward.
2. Remove the floor lid.
3. Remove the luggage area floor lid.

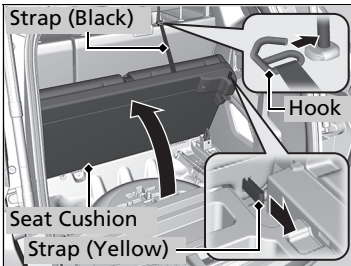
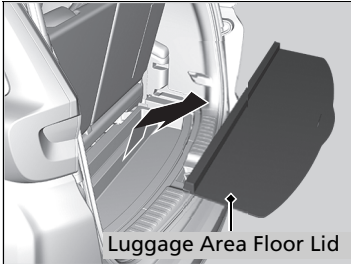

4. Unlock the seat cushion by pulling the strap (Yellow). Push the seat cushion forward, then hook the strap (Black) to the head restraint.

Changing a Flat Tyre

Make sure all items in the luggage area or items extending to the third row seats are properly secured. Loose items can fly forward if you have to brake hard.

WARNING: The jack can only be used for helping an emergency vehicle breakdown, not for changing the regular seasonal tyre or any other normal maintenance or repair operation.

NOTICE

Do not use the jack if it doesn't work properly. Call your dealer or a professional towing service.

Do not use the compact spare tyre if you are towing a trailer.

Continued

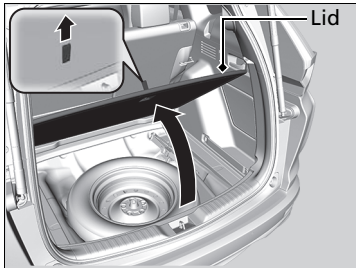

Models without third row seat

5. Open the luggage area floor lid.

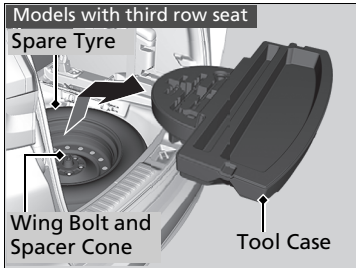

Models with third row seat

6. Take the tool case out of the luggage area. Take the wheel nut wrench and jack handle bar out of the tool case.

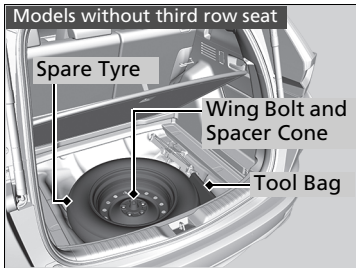

Models without third row seat

6. Take the tool bag out of the luggage area. Take the wheel nut wrench and jack handle bar out of the tool bag.

►► Getting Ready to Replace the Flat Tyre

Be careful not to hurt yourself when removing or storing the spare tyre.

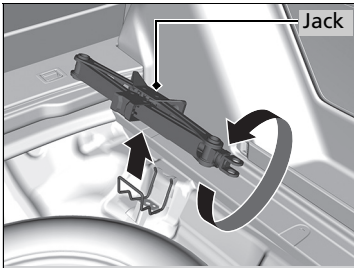

All models

7. Take the jack out of the spare tyre area.
8. Unscrew the wing bolt, and remove the spacer cone. Then, remove the spare tyre.

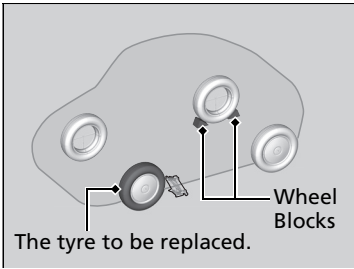

9. Place a wheel block or rock in front and rear of the wheel diagonal to the flat tyre.

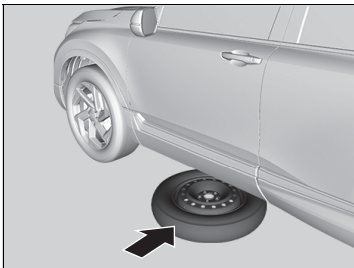

10. Place the compact spare tyre (wheel side up) under the vehicle body, near the tyre that needs to be replaced.



11. Loosen each wheel nut about one turn using the wheel nut wrench.

▶▶ How to Set Up the Jack

⚠ WARNING

The vehicle can easily roll off the jack, seriously injuring anyone underneath.

Follow the directions for changing a tyre exactly, and no person should place any portion of their body under a vehicle that is supported by a jack.

How to Set Up the Jack

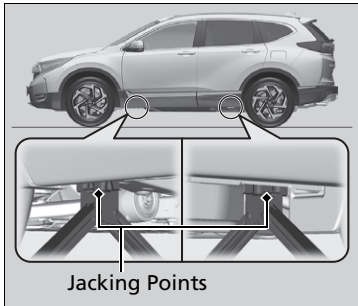

1. Place the jack under the jacking point closest to the tyre to be changed.

WARNING: The jack shall be placed on a flat and stable surface on the same level as the vehicle is parked.

The jack that came with your vehicle has the following label.

1.	2.	3.

1. See Owner's Manual.
2. Never get under vehicle when supported by jack.
3. Place jack underneath reinforced area.

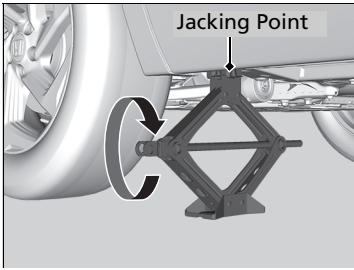

2. Turn the end bracket clockwise as shown in the image until the top of the jack contacts the jacking point.
 - ▶ Make sure that the jacking point tab is resting in the jack notch.

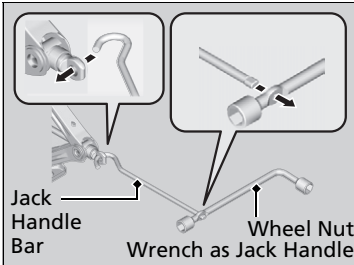

3. Raise the vehicle, using the jack handle bar and the jack handle, until the tyre is off the ground.

How to Set Up the Jack

Do not use the jack with people or luggage in the vehicle.

Use the jack provided in your vehicle. Other jacks may not support the weight ("load") or may not fit the jacking point.

The following instructions must be followed to use the jack safely:

- Do not use while the engine is running.
- Use only where the ground is firm and level.
- Use only at the jacking points.
- Do not get in the vehicle while using the jack.
- Do not put anything on top of or underneath the jack.

■ Replacing the Flat Tyre

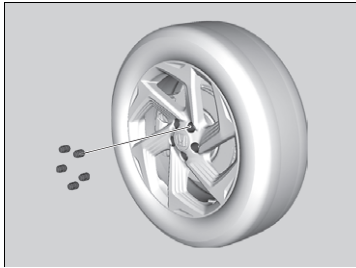

1. Remove the wheel nuts and flat tyre.

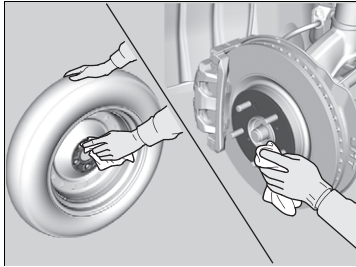

2. Wipe the mounting surfaces of the wheel with a clean cloth.

3. Mount the compact spare tyre.

4. Screw the wheel nuts until they touch the lips around the mounting holes, then stop rotating.

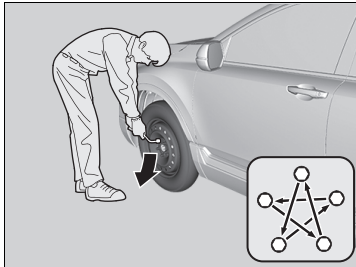

5. Lower the vehicle and remove the jack. Tighten the wheel nuts in the order indicated in the image. Go around, tightening the nuts, two to three times in this order.

Wheel nut torque:

108 N·m (11 kgf·m, 80 lbf·ft)

▣ Replacing the Flat Tyre

Do not over tighten the wheel nuts by applying extra torque using your foot or a pipe.

■ Storing the Flat Tyre

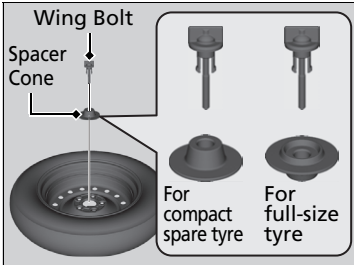
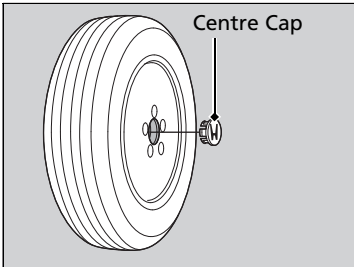

1. Remove the centre cap.
2. Place the flat tyre face down in the spare tyre well.
3. Remove the spacer cone from the wing bolt, flip it over, and insert it back on the bolt. Secure the flat tyre with the wing bolt.
4. Securely store the wheel nut wrench and jack handle bar back in the tool bag* or tool case*. Store the bag in the luggage area.
5. Store the jack in its holder. Turn the jack's end bracket to lock it in place.

▶▶ Storing the Flat Tyre



⚠ WARNING

Loose items can fly around the interior in a crash and can seriously injure the occupants.
Store the wheel, jack, and tools securely before driving.

* Not available on all models

Continued

■ Deflation Warning System and the Spare Tyre

If you replace a flat tyre with the spare tyre, the  indicator comes on while you are driving. After driving for a few kilometres (miles), the indicator will start blinking for a short time and then stay on.  appears on the driver information interface, but this is normal.

Initialise the deflation warning system when you replace the tyre with a specified regular tyre.

➤ **Deflation Warning System Initialisation** P. 551

Checking the Engine

If the engine does not start, check the starter.

Checking the Engine

If you must start the vehicle immediately, use an assisting vehicle or booster battery to jump start it.

➤ **Jump Starting** P. 746

Starter condition	Checklist
<p>Starter doesn't turn or turns over slowly.</p> <p>The battery may be dead. Check each of the items on the right and respond accordingly.</p>	<p>Models with keyless access system</p> <p>Check for a message on the driver information interface</p> <ul style="list-style-type: none">• If  appears.<ul style="list-style-type: none">➤ If the Keyless Remote Battery is Weak P. 744▶ Make sure the keyless remote is in its operating range.<ul style="list-style-type: none">➤ ENGINE START/STOP Button Operating Range P. 218 <p>Check the brightness of the interior lights.</p> <p>Turn on the interior lights and check the brightness.</p> <ul style="list-style-type: none">• If the interior lights are dim or do not come on at all ➤ Battery P. 712• If the interior lights come on normally ➤ Fuses P. 758
<p>The starter turns over normally, but the engine doesn't start.</p> <p>There may be a problem with a fuse. Check each of the items on the right and respond accordingly.</p>	<p>Review the engine start procedure.</p> <p>Follow its instructions, and try to start the engine again. ➤ Starting the Engine P. 514, 517</p> <p>Check the immobilizer system indicator.</p> <p>When the immobilizer system indicator is blinking, the engine cannot be started.</p> <p>➤ Immobilizer System P. 204</p>
	<p>Check the fuel level.</p> <p>There should be enough fuel in the tank. ➤ Fuel Gauge P. 147</p>
	<p>Check the fuse.</p> <p>Check all fuses or have the vehicle checked by a dealer. ➤ Inspecting and Changing Fuses P. 764</p>
	<p>If the problem continues:</p> <p>➤ Emergency Towing P. 765</p>

Models with keyless access system

If the Keyless Remote Battery is Weak

If the beeper sounds and  appears on the driver information interface; and the **ENGINE START/STOP** button flashes, and the engine will not start. Start the engine as follows:

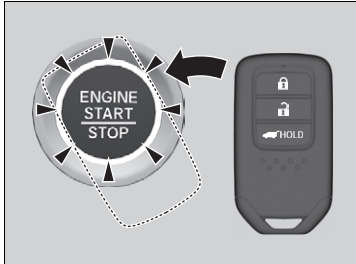

1. Touch the centre of the **ENGINE START/STOP** button with the **H** logo on the keyless remote while the **ENGINE START/STOP** button is flashing. The buttons on the keyless remote should be facing you.
 - ▶ The **ENGINE START/STOP** button flashes for about 30 seconds.

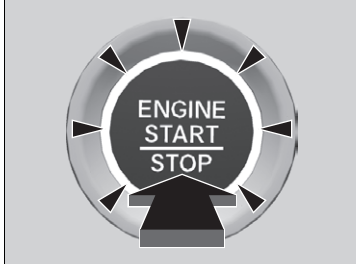

2. Depress the brake pedal and press the **ENGINE START/STOP** button within 10 seconds after the beeper sounds and the **ENGINE START/STOP** button changes from flashing to on.
 - ▶ If you don't depress the pedal, the mode will change to ACCESSORY.

Models with keyless access system

Emergency Engine Stop

The **ENGINE START/STOP** button may be used to stop the engine due to an emergency situation even while driving. If you must stop the engine, do either of the following operations:

- Press and hold the **ENGINE START/STOP** button for about two seconds.
- Firmly press the **ENGINE START/STOP** button three times.

The steering wheel will not lock.

Continuously variable transmission models

The power mode is in ACCESSORY when the engine is stopped.

To change the mode to VEHICLE OFF, move the shift lever to **[P]** after the vehicle comes to a complete stop. Then press the **ENGINE START/STOP** button twice without depressing the brake pedal.

Manual transmission models

The power mode changes to VEHICLE OFF.

Emergency Engine Stop

Do not press the button while driving unless it is absolutely necessary for the engine to be turned off.

Jump Starting Procedure

Turn off the power to electric devices, such as audio and lights. Turn off the engine, then open the bonnet.

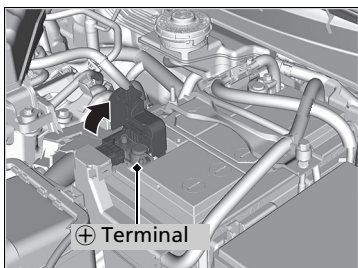

1. Open the terminal cover on your vehicle's battery positive \oplus terminal.

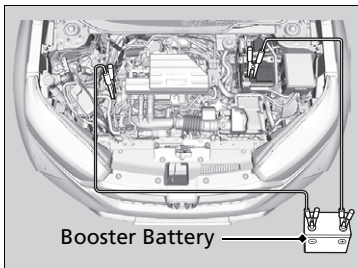

2. Connect the first jumper cable to your vehicle's battery \oplus terminal.
3. Connect the other end of the first jumper cable to the booster battery \oplus terminal.
 - ▶ Use a 12-volt booster battery only.
 - ▶ When using an automotive battery charger to boost your 12-volt battery, select a lower charging voltage than 15 volts. Check the charger manual for the proper setting.
4. Connect the second jumper cable to the booster battery \ominus terminal.

Jump Starting

WARNING

A battery can explode if you do not follow the correct procedure, seriously injuring anyone nearby.

Keep all sparks, open flames, and smoking materials away from the battery.

NOTICE

If a battery sits in extreme cold, the electrolyte inside can freeze. Attempting to jump start with a frozen battery can cause it to rupture.

Securely attach the jumper cables clips so that they do not come off when the engine vibrates. Also be careful not to tangle the jumper cables or allow the cable ends to touch each other while attaching or detaching the jumper cables.

Battery performance degrades in cold conditions and may prevent the engine from starting.

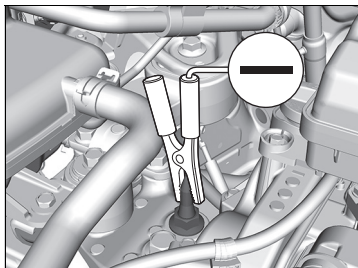

5. Connect the other end of the second jumper cable to the engine mounting bolt (as shown). Do not connect this jumper cable to any other part.
6. If your vehicle is connected to another vehicle, start the assisting vehicle's engine and increase its rpm slightly.
7. Attempt to start your vehicle's engine. If it turns over slowly, check that the jumper cables have good metal-to-metal contact.

What to Do After the Engine Starts

Once your vehicle's engine has started, remove the jumper cables in the following order.

1. Disconnect the jumper cable from your vehicle's ground.
2. Disconnect the other end of the jumper cable from the booster battery ⊖ terminal.
3. Disconnect the jumper cable from your vehicle's battery ⊕ terminal.
4. Disconnect the other end of the jumper cable from the booster battery ⊕ terminal.

Have your vehicle inspected by a nearby service station or a dealer.

* 1: Models with the keyless access system have an **ENGINE START/STOP** button instead of an ignition switch.

* Not available on all models

What to Do After the Engine Starts

The indicators for the Adaptive Cruise Control (ACC)*/Adaptive Cruise Control (ACC) with Low Speed Follow (LSF)*, road departure mitigation system, Vehicle Stability Assist (VSA) system, VSA OFF, Collision Mitigation Braking System (CMBS), low tyre pressure/deflation warning system*, and parking brake and brake system (amber) may come on along with a message in the driver information interface when you turn the ignition switch to ON **II***¹ after reconnecting the battery.

Drive a short distance at more than 20 km/h (12 mph). The indicator should go off. If it does not, have your vehicle checked by a dealer.

Shift Lever Does Not Move*

Follow the procedure below if you cannot move the shift lever out of the **P** position.

Releasing the Lock

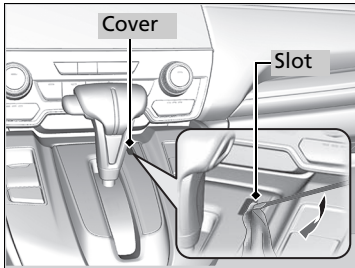

1. Set the parking brake.

Models without keyless access system

2. Remove the key from the ignition switch.

Models with keyless access system

2. Remove the built-in key from the keyless remote.

All models

3. Wrap a cloth around the tip of a small flat-tip screwdriver. Put it into the shift lock release slot as shown in image, and remove the cover.

4. Insert the key into the shift lock release slot.
5. While pushing the key down, press the shift lever release button, and place the shift lever into **N**.

► The lock is now released. Have the shift lever checked by a dealer as soon as possible.

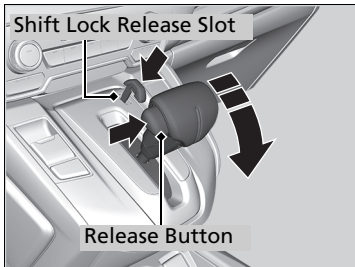

How to Handle Overheating

Overheating symptoms are as follows:

- The temperature gauge needle is at upper level or the engine suddenly loses power.
- Steam or spray comes out of the engine compartment.

■ First thing to do

1. Immediately park the vehicle in a safe place.
2. Turn off all accessories and turn on the hazard warning lights.

▶ No steam or spray present:

Keep the engine running and open the bonnet.

▶ Steam or spray present:

Turn off the engine and wait until it subsides. Then, open the bonnet.

☒ How to Handle Overheating

⚠ WARNING

Steam and spray from an overheated engine can seriously scald you.

Do not open the bonnet if steam is coming out.

NOTICE

Continuing to drive with the temperature gauge needle at upper level may damage the engine.

■ Next thing to do

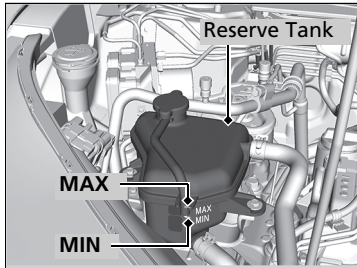

1. Check that the cooling fan is operating and stop the engine once the temperature gauge needle comes down.
 - If the cooling fan is not operating, immediately stop the engine.
2. Once the engine has cooled down, inspect the coolant level, and check the cooling system components for leaks.
 - If the coolant level in the reserve tank is low, or no coolant in the tank, check that the radiator is cool. Cover the reserve tank cap with a heavy cloth and open the cap. Add coolant until it reaches the **MAX** mark and put the cap back on.

■ Last thing to do

Once the engine has cooled sufficiently, restart it, and check the temperature gauge.

If the temperature gauge needle has gone down, resume driving. If it has not gone down, contact a dealer for repairs.

► How to Handle Overheating

⚠ WARNING

Removing the reserve tank cap while the engine is hot can cause the coolant to spray out, seriously scalding you.

Always let the engine and radiator cool down before removing the reserve tank cap.

If the coolant is leaking, contact a dealer for repairs.

Use water as an emergency/temporary measure only. Have a dealer flush the system with proper antifreeze as soon as possible.

If the Low Oil Pressure Indicator Comes On



■ Reasons for the indicator to come on

Comes on when the engine oil pressure is low.

■ What to do as soon as the indicator comes on

1. Immediately park the vehicle on level ground in a safe place.
2. If necessary, turn the hazard warning lights on.

■ What to do after parking the vehicle

1. Stop the engine and let it sit for approximately three minutes.
2. Open the bonnet and check the oil level.

📖 **Oil Check** P. 685

3. Start the engine and check the low oil pressure indicator.
 - ▶ The indicator goes off: Start driving again.
 - ▶ The indicator does not go off within 10 seconds: Immediately stop the engine and contact a dealer for repairs.

If the Charging System Indicator Comes On



■ Reasons for the indicator to come on

Comes on when the battery is not being charged.

■ What to do when the indicator comes on

Turn off the climate control system, rear demister, and other electrical systems. Immediately contact a dealer for repairs.

☒ If the Low Oil Pressure Indicator Comes On

NOTICE

Running the engine with low oil pressure can cause serious mechanical damage almost immediately.

☒ If the Charging System Indicator Comes On

If you need to stop temporarily, do not turn off the engine. Restarting the engine may rapidly discharge the battery.

If the Malfunction Indicator Lamp Comes On or Blinks



■ Reasons for the indicator lamp to come on or blink

- Comes on if there is a problem with the engine emissions control system.
- Blinks when engine misfiring is detected.

■ What to do when the indicator lamp comes on

Avoid high speeds and immediately get your vehicle inspected at a dealer.

■ What to do when the indicator lamp blinks

Park the vehicle in a safe place with no flammable items and wait at least 10 minutes or more with the engine stopped until it cools.

▶ If the Malfunction Indicator Lamp Comes On or Blinks

NOTICE

If you drive with the malfunction indicator lamp on, the emissions control system and the engine could be damaged.

If the malfunction indicator lamp blinks again when restarting the engine, drive to the nearest dealer at 50 km/h (30 mph) or less. Have your vehicle inspected.

If the Brake System Indicator (Red) Comes On or Blinks



(Red)

■ Reasons for the indicator to come on

- The brake fluid is low.
- There is a malfunction in the brake system.

■ What to do when the indicator comes on while driving

Depress the brake pedal lightly to check pedal pressure.

- If normal, check the brake fluid level the next time you stop.
- If abnormal, take immediate action. If necessary, downshift the transmission to slow the vehicle using engine braking.

■ Reasons for the indicator to blink

- There is a problem with the electric parking brake system.

■ What to do when the indicator blinks

- Avoid using the parking brake and have your vehicle checked by a dealer immediately.

☒ If the Brake System Indicator (Red) Comes On or Blinks

Have your vehicle repaired immediately. It is dangerous to drive with low brake fluid. If there is no resistance from the brake pedal, stop immediately in a safe place. If necessary, downshift the gears.

If the brake system indicator and **ABS** indicator come on simultaneously, the electronic brake distribution system is not working. This can result in vehicle instability under sudden braking. Have your vehicle inspected by a dealer immediately.

If the brake system indicator (red) blinks at the same time when the brake system indicator (amber) comes on, the parking brake may not work. Avoid using the parking brake and have your vehicle checked by a dealer immediately.

☒ **If the Brake System Indicator (Red) Comes On or Blinks at the Same Time When the Brake System Indicator (Amber) Comes On**
P. 754

If the Brake System Indicator (Red) Comes On or Blinks at the Same Time When the Brake System Indicator (Amber) Comes On



(Red)

■ **If the brake system indicator (red) comes on or blinks at the same time when the brake system indicator (amber) comes on, release the parking brake manually or automatically**

🔧 **Parking Brake** P. 629



(Amber)

- If the brake system indicator (red) continuously comes on or blinks at the same time when the brake system indicator (amber) comes on, stop the vehicle in a safe place and have it inspected by a dealer immediately.

▶ Preventing the vehicle from moving

Continuously variable transmission models

Move the shift lever to **P**.

Manual transmission models

Move the shift lever to **1** or **R**.

- If only the brake system indicator (red) is turned off, avoid using the parking brake and have your vehicle checked by a dealer immediately.

🔍 If the Brake System Indicator (Red) Comes On or Blinks at the Same Time When the Brake System Indicator (Amber) Comes On

If you apply the parking brake, you may not be able to release it.

If the brake system indicator (red) and the brake system indicator (amber) come on at the same time, the parking brake is working.

If the brake system indicator (red) blinks at the same time when the brake system indicator (amber) comes on, the parking brake may not work because it is checking the system.

If the Electric Power Steering (EPS) System Indicator Comes On



■ Reasons for the indicator to come on

- Comes on if there is a problem with the EPS system.
- If you depress the accelerator pedal repeatedly to increase the engine speed while the engine is idling, the indicator comes on, and sometimes the steering wheel becomes harder to operate.

■ What to do when the indicator comes on

Stop the vehicle in a safe place and restart the engine.

If the indicator comes on and stays on, immediately have your vehicle inspected by a dealer.

If the Low Tyre Pressure/Deflation Warning System Indicator Comes On or Blinks



■ Reasons for the indicator to come on or blink

A tyre pressure is significantly low, or the deflation warning system has not been initialised. If there is a problem with the deflation warning system, the indicator blinks for about one minute, and then stays on. If the compact spare tyre is installed, the indicator will either come on or it will first blink for about one minute, then stay on.

■ What to do when the indicator comes on

Drive carefully avoiding abrupt cornering and hard braking. Stop your vehicle in a safe place. Check the tyre pressure and adjust the pressure to the specified level. The specified tyre pressure is on a label on the driver side doorjamb.

- ▶ Initialise the deflation warning system after the tyre pressure is adjusted.

🔧 Deflation Warning System Initialisation P. 551

If the compact spare tyre causes the indicator to come on, change the tyre to a full-size tyre. The indicator goes off after initialising the deflation warning system.

■ What to do when the indicator blinks, then remains on

Have the tyre inspected by a dealer as soon as possible. If the compact spare tyre causes the indicator to first blink, and then stay on, change the tyre to a full-size tyre. The indicator goes off after initialising the deflation warning system.

🔧 If the Low Tyre Pressure/Deflation Warning System Indicator Comes On or Blinks

NOTICE

Driving on an extremely underinflated tyre can cause it to overheat. An overheated tyre can fail. Always inflate your tyres to the prescribed level.

If the Low Oil Level Symbol Appears



■ Reasons for the symbol to appear

Appears when the engine oil level is low.

■ What to do as soon as the symbol appears

1. Immediately park the vehicle on level ground in a safe place.
2. If necessary, turn the hazard warning lights on.

■ What to do after parking the vehicle

1. Stop the engine and let it sit for about three minutes.
2. Open the bonnet and check the oil level.

➤ **Oil Check** P. 685

☒ If the Low Oil Level Symbol Appears

NOTICE

Running the engine with low oil level can cause serious mechanical damage almost immediately.

This system activates after the engine warms up. If the outside temperature is extremely low, you may have to drive for a long time until the system senses the engine oil level.

If the symbol appears again, stop the engine and contact a dealer for repairs immediately.

Fuse Locations

If any electrical devices are not working, turn the ignition switch to LOCK **0***1 and check to see if any applicable fuse is blown.

■ Engine Compartment Fuse Box

Located near battery. Push the tabs to open the box.

Fuse locations are shown on the image below.

Locate the fuse in question by the fuse number in the image and chart.

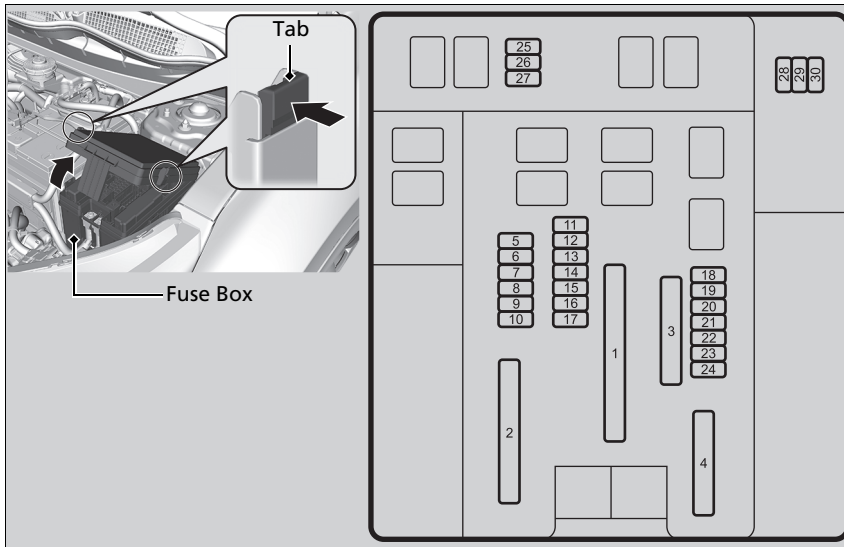

*1: Models with the keyless access system have an **ENGINE START/STOP** button instead of an ignition switch.

■ **Circuit protected and fuse rating**

	Circuit Protected	Amps
1	DCDC1*	30 A
	EBB	40 A
	MAIN FAN	30 A
	R/MOD1	30 A
	IG MAIN 2*	30 A
	R/MOD2	30 A
	MAIN FUSE	125 A
	EPS	70 A
2	IG MAIN	30 A ^{*1} 50 A ^{*2}
	FUSE BOX OPTION	40 A
	FUSE BOX MAIN	60 A
	WIPER	30 A
	SUB FAN	30 A
3	REAR DEFROSTER	40 A
	STARTER MOTOR	30 A
	FUSE BOX MAIN2	40 A
	ABS/VSA MOTOR	40 A
	ABS/VSA FSR	40 A
	BLOWER MOTOR	40 A
4	OP BLOCK 1*	40 A
	OP BLOCK 2	40 A
	DCDC2*	30 A
	POWER TAIL GATE*	40 A
5	VB ACT	7.5 A

	Circuit Protected	Amps
6	WASHER	15 A
7	IGP	15 A
8	FI SUB	15 A
9	STOP LIGHTS	10 A
10	INJECTOR	20 A
11	IGPS (LAF)	7.5 A
12	BACKUP FI ECU	10 A
13	FR R DEICER*	15 A
14	HAZARD	10 A
15	IG COIL	15 A
16	TCU*	15 A
17	HEADLIGHT WASHER*	30 A
18	BACK UP	10 A
19	AUDIO*	15 A
20	AWD*	20 A
21	REAR SEAT HEATER*	20 A
22	FR FOG*	15 A
23	VMP	10 A
24	HORN	10 A
25	IGP2 (SUB)	7.5 A
26	–	–
27	BACKUP2*	30 A
28	STARTER MOTOR*	7.5 A
29	STARTER MOTOR*	–
30	STARTER MOTOR*	–

*1: Models with keyless access system

*2: Models without keyless access system

* Not available on all models

Interior Fuse Box

Located under the dashboard.

Fuse locations are shown on the image below.

Locate the fuse in question by the fuse number in the image and chart.

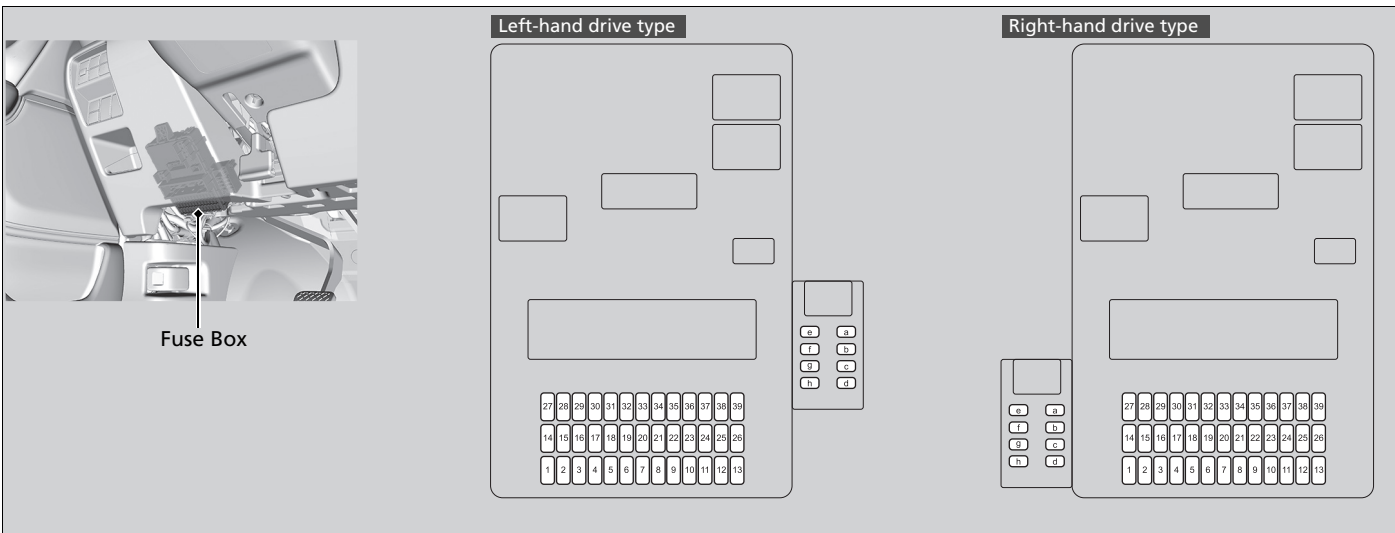

■ **Circuit protected and fuse rating**

	Circuit Protected	Amps
1	ACCESSORY	10 A
2	ACC KEY LOCK	5 A
3	IG1 OPTION 3	10 A
4	IG1 OPTION 2* ¹	5 A
	IG1 TCU* ² , * ³	10 A
5	IG1 OPTION	10 A
6	IG1 SRS 2	10 A
7	IG1 METER	10 A
8	IG1 FUEL PUMP	15 A
9	IG2 A/C	10 A
10	CTR ACCESSORY SOCKET	20 A
11	IG1 MONITOR	5 A
12	R SIDE DOOR LOCK	10 A
13	L SIDE DOOR UNLOCK	10 A
14	P/W RR L	20 A
15	P/W AS	20 A
16	DOOR LOCK	20 A
	IG1 TCU* ¹ , * ³	10 A
17	—* ¹ , * ⁴	—
	IG1 OPTION 2* ²	5 A
18	DR POWER LUMBAR*	10 A
19	PANORAMIC GLASS ROOF*	20 A
20	IG1 STARTER	10 A
21	IG1 ACG	10 A
22	IG2 DAYTIME LIGHT	10 A
23	REAR FOG LIGHT	10 A

* Not available on all models

	Circuit Protected	Amps
24	+B OPTION	5 A
25	DR DOOR LOCK	10 A
26	R SIDE DOOR UNLOCK	10 A
27	P/W RR R	20 A
28	P/W DR	20 A
29	FR ACCESSORY SOCKET	20 A
30	SMART* ¹	10 A
	STS* ²	5 A
31	DR P/SEAT RECLINE*	20 A
32	FR HEATED SEAT*	20 A
33	DR P/SEAT SLIDE*	20 A
34	IG1 ABS/VSA	10 A
35	IG1 SRS	10 A
36	HAC OPTION	20 A
37	+B TRAILER	15 A
38	L SIDE DOOR LOCK	10 A
39	DR DOOR UNLOCK	10 A
a	PTG*	20 A
b	AUDIO AMP*	20 A
c	SUPER LOCKING*	15 A
d	SUNSHADE*	20 A
e	—	—
f	EPT L	20 A
g	EPT R	20 A
h	ACCESSORY SOCKET (CARGO)	20 A

*1: Models with keyless access system

*2: Models without keyless access system

*3: Continuously variable transmission models

*4: Manual transmission models

Models with Auto Idle Stop system

Located under the dashboard.

Fuse locations are shown on the image below.

Locate the fuse in question by the fuse number in the image and chart.

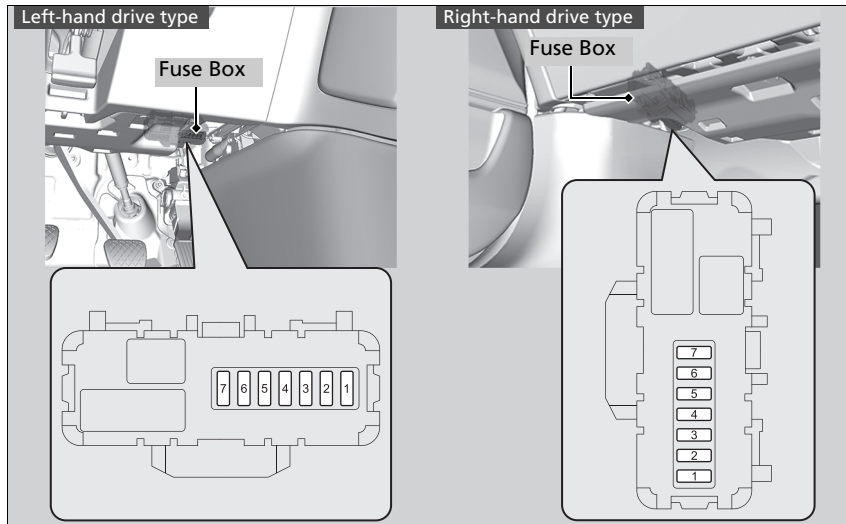

■ Circuit protected and fuse rating

	Circuit Protected	Amps
1	VST ACC1	5 A
2	BACKUP2 MAIN	15 A
3	EOP	7.5 A
4	VSA	5 A
5	VSA1	7.5 A
6	METER VST	5 A
7	VSA2	7.5 A

Inspecting and Changing Fuses

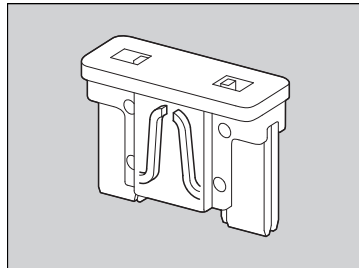
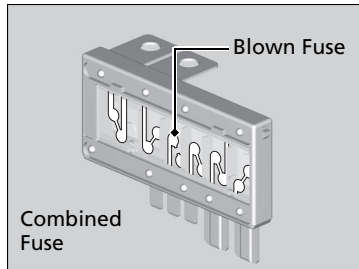

1. Turn the ignition switch to LOCK **0***1. Turn headlights and all accessories off.
2. Remove the fuse box cover.
3. Check the large fuse in the engine compartment.
 - If the fuse is blown, use a Phillips-head screwdriver to remove the screw and replace it with a new one.
4. Inspect the small fuses in the engine compartment and the vehicle interior.
 - If there is a blown fuse, remove it and replace it with a new one.

Inspecting and Changing Fuses

NOTICE

Replacing a fuse with one that has a higher rating greatly increases the chances of damaging the electrical system.

Replace fuse with a spare fuse of the same specified amperage.

Use the charts to locate the fuse in question and confirm the specified amperage.

► **Fuse Locations** P. 758, 760

*1: Models with the keyless access system have an **ENGINE START/STOP** button instead of an ignition switch.

Emergency Towing

Call a professional towing service if you need to tow your vehicle.

All models

■ Flat bed equipment

The operator loads your vehicle on the back of a truck.

This is the best way to transport your vehicle.

2WD models

■ Wheel lift equipment

The tow truck uses two pivoting arms that go under the front tyres and lift them off the ground. The rear tyres remain on the ground. **This is an acceptable way to tow your vehicle.**

» Emergency Towing

NOTICE

Trying to lift or tow your vehicle by the bumpers will cause serious damage. The bumpers are not designed to support the vehicle's weight.

NOTICE

Improper towing, such as towing behind a motorhome or other motor vehicle can damage the transmission.

Never tow your vehicle with just a rope or chain. It is very dangerous since ropes or chains may shift from side to side or break.

Right-hand drive type

Before towing your vehicle, deactivate the security system's tilt sensor if you have to set the system.

➤ **Security System Alarm** P. 205

What to Do When Unable to Open the Tailgate

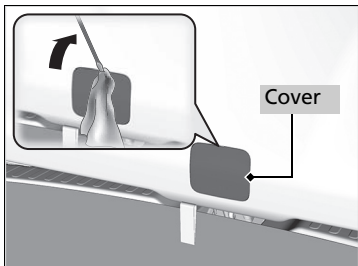

If you cannot open the tailgate, use the following procedure.

1. Use a flat-tip screwdriver and remove the cover on the inside of the tailgate.
 - ▶ Wrap the flat-tip screwdriver with a cloth to prevent scratches.

What to Do When Unable to Open the Tailgate

Following up:

After taking these steps, contact a dealer to have the vehicle checked.

When you open the tailgate from inside, make sure there is enough space around the tailgate, and it does not hit anyone or any object.

Models with power tailgate

Left-hand drive type

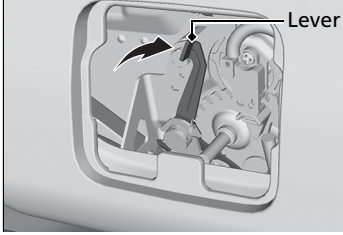

Models with power tailgate

Right-hand drive type

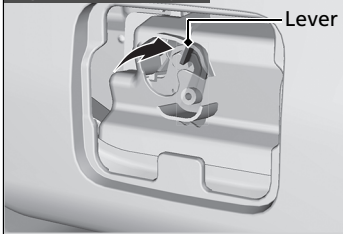

Models without power tailgate

Screwdriver

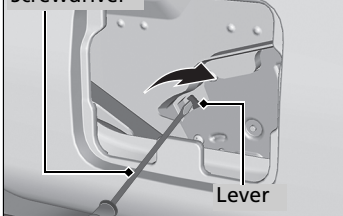

2. To open the tailgate, push the tailgate while pushing the lever to the right.

Information

This chapter includes your vehicle's specifications, locations of identification numbers, and other information required by regulation.

Specifications	770
Identification Numbers	
Vehicle Identification Number (VIN), Engine Number and Transmission Number	773
Devices that Emit Radio Waves	774
EC Declaration of Conformity Content Outline*	806

■ Vehicle Specifications

Model	CR-V
Curb Weight	1,501-1,523 kg (3,309-3,358 lbs) ^{*1} 1,598-1,705 kg (3,523-3,759 lbs) ^{*2, *3} 1,573-1,680 kg (3,468-3,704 lbs) ^{*2, *4}
Maximum Permissible Weight	See the certification label on the driver's doorjamb ^{*5} See the certification label on the front passenger's doorjamb ^{*6}
Maximum Permissible Axle Weight	See the certification label on the driver's doorjamb ^{*5} See the certification label on the front passenger's doorjamb ^{*6}

*1: 2WD models

*2: AWD models

*3: Continuously variable transmission models

*4: Manual transmission models

*5: Left-hand drive type

*6: Right-hand drive type

■ Engine Specifications

Type	4V/DOHC/TURBO
Bore x Stroke	73 x 89.5 mm (2.87 x 3.52 in)
Displacement	1,498 cm ³ (91.4 cu-in)
Compression Ratio	10.3 : 1
Spark Plugs	NGK ILZKAR8J85Y

■ Fuel

Type	EN 228 standards petrol/gasohol fuel Unleaded premium petrol/gasohol up to E10 (90% petrol and 10% ethanol), research octane number 95 or higher
Fuel Tank Capacity	57 L (12.5 Imp gal)

■ Battery

Capacity	48AH(5)/60AH(20)
----------	------------------

Idle Stop:

The battery installed in this vehicle is specifically designed for a model with Auto Idle Stop. If you need to replace the battery, make sure to select the specified type (LN2). Ask a dealer for more details.

■ Washer Fluid

Tank Capacity	2.5 L (2.2 Imp qt) ^{*1} 4.5 L (4.0 Imp qt) ^{*2}
---------------	--

*1: Right-hand drive type

*2: Left-hand drive type

■ Light Bulbs

Headlights (High/Low Beam)	LED
Front Fog Lights*	LED* 35 W (H8)*
Front Turn Signal Lights	LED
Daytime Running Lights/Position Lights	LED
Active Cornering Lights*	LED
Side Turn Signal Lights (on Door Mirrors)	LED
Taillights	LED
Brake/Taillights	LED
Rear Turn Signal Lights	LED
Back-Up Lights	16 W
Rear Fog Light	LED
High-Mount Brake Light	LED
Rear Licence Plate Light	LED
Interior Lights	
Front Map Light	LED
Rear Map Light	LED
Luggage Area Light(s)	5 W
Vanity Mirror Lights*	2.0 W
Glove Box Light*	3.4 W
Console Compartment Light	LED
Foot Light(s)	LED
Door Inner Handle Lights*	LED

■ Brake/Clutch* Fluid

Specified	Brake Fluid with DOT3 or DOT4
-----------	-------------------------------

■ Continuously Variable Transmission Fluid*

Specified	Honda HCF-2 Transmission Fluid	
Capacity	Change	4.3 L (3.8 Imp qt)

■ Manual Transmission Fluid*

Specified	Honda Manual Transmission Fluid (MTF)	
Capacity	Change	1.9 L (1.7 Imp qt) ^{*1} 2.2 L (1.9 Imp qt) ^{*2}

- *1: 2WD models
- *2: AWD models

■ Engine Oil

Recommended	European and Ukrainian models	
	Genuine Honda Engine Oil Type 2.0 ACEA C2/C3 0W-30, 5W-30, 10W-30	
	Except European and Ukrainian models	
	Genuine Honda Motor Oil 0W-20 ACEA C2/C3 0W-30, 5W-30, 10W-30	
Capacity	Change	3.2 L (2.8 Imp qt)
	Change including filter	3.5 L (3.1 Imp qt)

■ Rear Differential Fluid*

Specified	Honda DPSF II	
Capacity	Change	1.2 L (1.1 Imp qt)

■ Engine Coolant

Specified	Honda All Season Antifreeze/Coolant Type2	
Ratio	50/50 with distilled water	
Capacity	6.21 L (1.37 Imp gal) ^{*1}	
	6.19 L (1.36 Imp gal) ^{*2, *3}	
	6.18 L (1.36 Imp gal) ^{*4}	
	(change including the remaining 0.75 L (0.17 Imp gal) in the reserve tank)	

- *1: Left-hand drive type with continuously variable transmission
- *2: Right-hand drive type with continuously variable transmission
- *3: Left-hand drive type with manual transmission
- *4: Right-hand drive type with manual transmission

■ Tyre

Regular	Size ^{*1}	235/55R19 101Y 235/60R18 103H 235/65R17 104H
	Pressure	See the label on driver's doorjamb
	Size	T155/90D17 112M
Compact Spare	Pressure kPa (bar [psil])	420 (4.2 [60])
Wheel Size	Regular	17 x 7 1/2J ^{*2} 18 x 7 1/2J ^{*3} 19 x 7 1/2J ^{*4}
	Compact Spare	17 x 4T

- *1: Original tyre size is mentioned on the tyre information label on the driver's doorjamb.
- *2: Models with 235/65R17
- *3: Models with 235/60R18
- *4: Models with 235/55R19

■ Brake

Type	Power assisted
Front	Ventilated disc
Rear	Solid disc
Parking	Electric Parking Brake

■ Air Conditioning

Refrigerant Type	HFO-1234yf (R-1234yf)
Charge Quantity	435 - 485 g

■ Vehicle Dimensions

Length	4,600 mm (181.1 in)	
Width	1,855 mm (73.0 in)	
Height	1,657 mm (65.2 in) ^{*1}	
	1,667 mm (65.6 in) ^{*2}	
Wheelbase	2,663 mm (104.8 in) ^{*1}	
	2,662 mm (104.8 in) ^{*2}	
Track	Front	1,602 mm (63.1 in) ^{*1} 1,601 mm (63.0 in) ^{*2}
	Rear	1,630 mm (64.2 in) ^{*1} 1,629 mm (64.1 in) ^{*2}

- *1: 2WD models
- *2: AWD models

* Not available on all models

■ The mounting point/rear over hang of coupling device

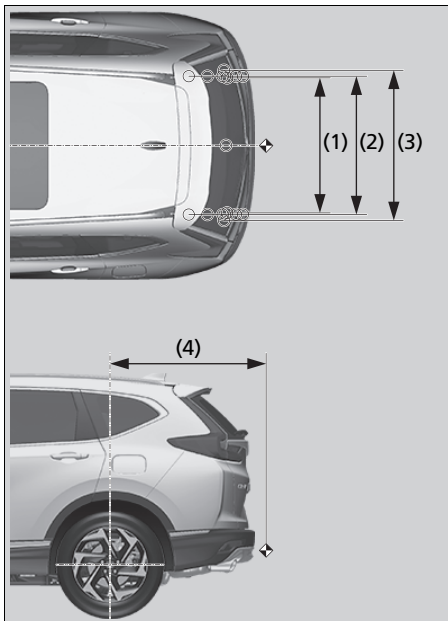

NOTE:

1. ○ marks show towbar fixing points.
2. ◀ mark shows towbar coupling point.

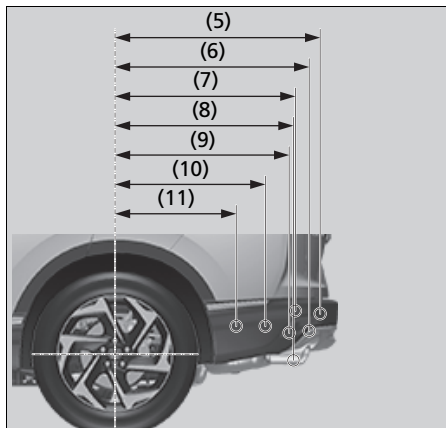

No.	Dimensions
(1)	958 mm (37.7 in)
(2)	963 mm (37.9 in)
(3)	1,042 mm (41.0 in)
(4)	1,116 mm (43.9 in)
(5)	925 mm (36.4 in) ^{*1}
	926 mm (36.5 in) ^{*2}
(6)	876 mm (34.5 in) ^{*1}
	877 mm (34.5 in) ^{*2}
(7)	813 mm (32.0 in) ^{*1}
	814 mm (32.0 in) ^{*2}
(8)	807 mm (31.8 in) ^{*1}
	808 mm (31.8 in) ^{*2}
	784 mm (30.9 in) ^{*1}
	785 mm (30.9 in) ^{*1}
(9)	785 mm (30.9 in) ^{*2}
	786 mm (30.9 in) ^{*2}
(10)	677 mm (26.7 in) ^{*1}
	678 mm (26.7 in) ^{*2}
(11)	547 mm (21.5 in) ^{*1}
	548 mm (21.6 in) ^{*2}

*1: 2WD models
*2: AWD models

■ Max. Towing Weight

Trailer with brakes	Manual Transmission Models	2,000 kg (4,409 lbs) ^{*1}
	Continuously Variable Transmission Models	1,800 kg (3,968 lbs) ^{*2}
Trailer without brakes	Manual Transmission Models	600 kg (1,323 lbs)
	Continuously Variable Transmission Models	600 kg (1,323 lbs)
The maximum permissible vertical load on the coupling device		100 kg (220 lbs)

*1: Models without third row seat
*2: Models with third row seat

Vehicle Identification Number (VIN), Engine Number and Transmission Number

Your vehicle has a 17-digit vehicle identification number (VIN) used to register your vehicle for warranty purposes, and for licensing and insuring your vehicle. The locations of your vehicle's VIN, engine number and transmission number are shown as follows.

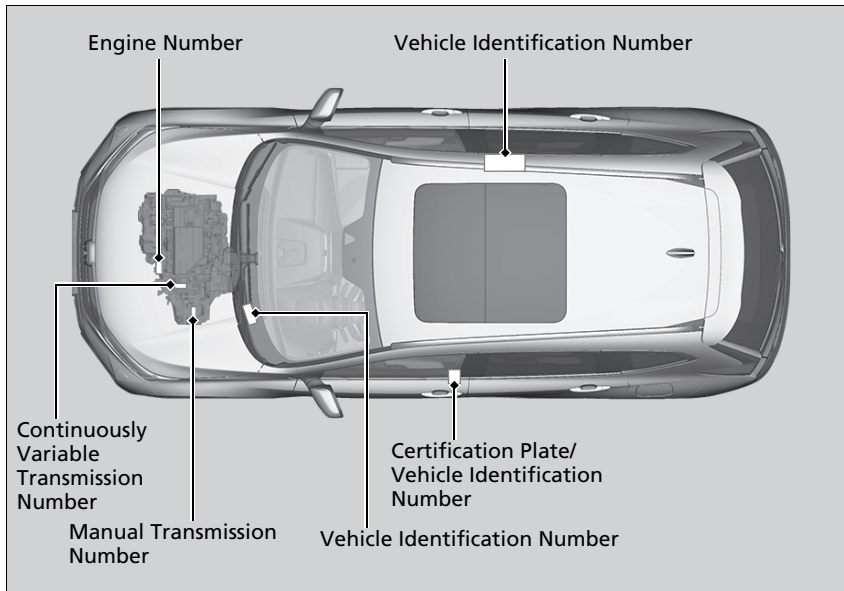

Vehicle Identification Number (VIN), Engine Number and Transmission Number

The interior vehicle identification number (VIN) is located under the cover.

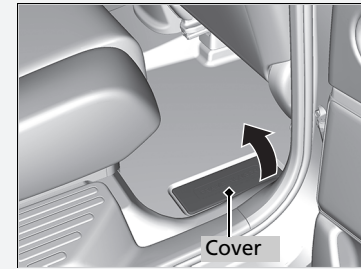

Devices that Emit Radio Waves

The following products and systems on your vehicle emit radio waves when in operation.

Moldova models

Remote Transmitter*



ERC/REC 70-03 Annex 1

Parametrii tehnici de emisie ai dispozitivelor cu rază mică de acțiune

echipamentul este destinat să fie utilizat în Republica Moldova

MINISTERUL TEHNOLOGIEI INFORMATIEI ȘI COMUNICAȚILOR AL REPUBLICII MOLDOVA
Întreprinderea de Stat „CENTRUL NAȚIONAL PENTRU FRECVENTE RADIO”

CERTIFICAT DE CONFORMITATE

Nr. de înregistrare: **SNACP MD 1024 11 A5175-15**
Data emiterii: 06 aprilie 2015 Valabil până la: 06 aprilie 2018

ORGANISMUL DE CERTIFICARE: OCpr - 014
Organism de certificare a produselor din Telecomunicații, Informatică și Poșta (OC TIP)
MD-2021, str. Drumul Văilor 28/2, min. Chișinău, tel: +373 22 735394, fax: +373 22 733941

PRIN PREZENTUL DOCUMENT SE CONFIRMĂ FAPTUL, CA PRODUSELE IDENTIFICATE ASTFEL:
DENUMIREA / DISCEREA: **Cok4 NM MD 8536**
Telecomandă radio pentru sistemul de acces și parcare a autovehiculului
marca comercială Honda Lock model HLIK6-3T
Fabricate în serie

SÎNT CONFORME CU CERINȚELE OBLIGATORII STABILITE ÎN:
ERC/REC 70-03 Anexa 1; GOST 30786-2001 p.5; Reglementarea Tehnică
"Echipamente radio, echipamente terminale de telecomunicații și rețeaua acestora
conformității acestora", aprobată prin HG nr.1274 din 23.11.2007; Reglementarea
tehnica "Parametrii tehnici de emisie ai dispozitivelor cu rază mică de acțiune",
aprobată prin Ordinul MTIC nr. 16 din 21.02.2014.

PRODUCĂTOR
Honda Lock Mfg Co., Ltd.,
3700, Shinotaka Sadowara-Cho, Miyazaki-Shi, Miyazaki 880-0293, Japan

SOLICITANT
Honda Lock Mfg Co., Ltd.,
535-14 Oaza-Ishizae, Takanezawamachi, Shioya-Gun, Tochigi, Japan

CERTIFICATUL ESTE ELIBERAT ÎN BAZA
- Raportului de încercări nr. 2982 din 26 martie 2015, Laboronul de încercări IJ CEM,
certificat de acreditare nr. IJ-045 din 06 iunie 2014, eliberat de CNA RM "MOLDAC";
- Certificatului sistemului de management al calității ISO 9001:2008 nr. JQA-2136
din 09 aprilie 2013, eliberat de JQA, Japan;
- Declarației de conformitate a producătorului din 03 iulie 2013.

INFORMAȚIE SUPPLEMENTARĂ:
Dispozitivul posedă a produselor certificate se va efectua în atd-lea au de valabilitate a Certificatului de Conf. emitate.
Echipamentul certificat poate fi utilizat în banda de frecvențe 413,05-414,79 MHz, cu puterea efectiv radiată P_{ef}: 10 mW.

*Tănuțul prezentului certificat este obligat să aplice marca națională de conformitate SM pe produsele specificate în prezentul
certificat, arhivă și/sau în documentația de însoțire.

Conducătorul organismului
de certificare  Anatolie GUZUN

Copilele certificatelor de conformitate
se legalizează de către OC TIP

Scrisoarea Nr. 0 00923

* Not available on all models

Moldova models

Immobilizer System*



ERC/REC 70-03 Annex 9

Parametrii tehnici de emisie ai dispozitivelor cu rază mică de acțiune

echipamentul este destinat să fie utilizat în Republica Moldova

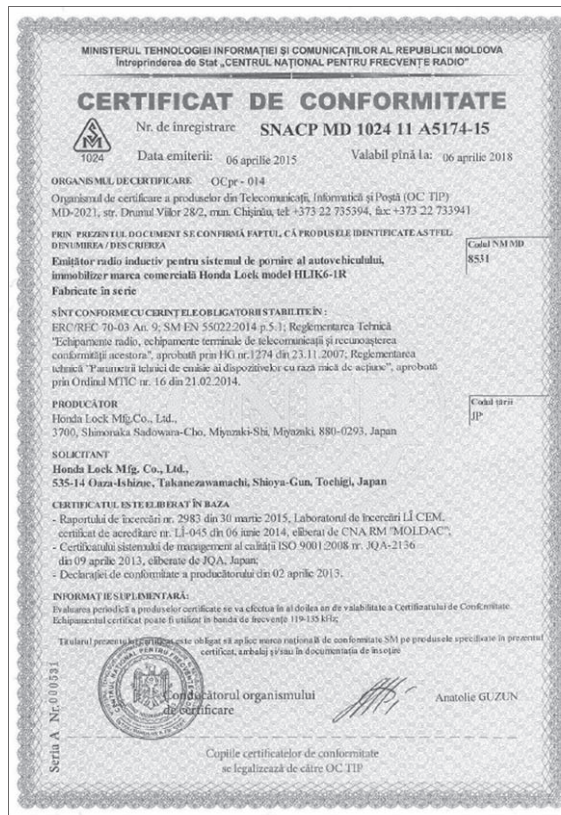

Moldova models

Keyless Access System*



European REC 70-03
Gost 30786-2001

This device is designed to be used in Republic of Moldova

Declarație de conformitate

Noi, Continental Automotive GmbH, Siemensstrasse 12, 93055 Regensburg, Germany
(denunțăm și adresa producătorului și, dacă este cazul, ale reprezentanților din autoritate care redactază declarația)

declaram pe propria noastră răspundere că produsul:

marca Continental

denumire comercială – V4x

tip sau model – V4x

la care se referă această declarație este în conformitate cu cerințele esențiale și celelalte prevederi aplicabile ale Regulamentului tehnic "Echipamente radio, echipamente terminale de telecomunicații și recunoașterea conformității acestora", aprobată prin Hotărârea Guvernului nr. 2 din 09.01.2014.

Produsul este în conformitate cu următoarele standarde și/sau documente normative:

Protecția sănătății [pct.7 lit.a)] EN 60950-1:2006 + A11:2009 + A1:2010

EN 62369-2:2009

Siguranța utilizatorului [pct.7 lit.a)] EN 60950-1:2006 + A11:2009 + A1:2010

EN 62369-2:2009

Compatibilitatea electromagnetică [pct.7 lit.b)] EN 301 489-1 V1.8.1 (2008-04)

EN 301 489-3 V1.4.1 (2002-08)

Spectrul radio [pct.8] EN 300 220-1 V2.3.1 (2010-02)

EN 300 220-2 V2.4.1 (2010-02)

Declarația de conformitate este emisă în baza

Certificat de conformitate, 11 aprilie 2013

Organismul de evaluare a conformității antrenat: SNACP MD 1025

Dossarul tehnic al echipamentului este disponibil la: Continental Automotive GmbH.

Locul și data emiterii declarației: Regensburg, 12.07.16

Numele (complet) al producătorului sau al persoanei autorizate: Continental Automotive GmbH

Funcția (titlul) producătorului sau al persoanei autorizate: Thomas Heselberger

Semnătura producătorului sau al persoanei autorizate

T. Kahl

Moldova models

Keyless Access System*



European REC 70-03
Gost 30786-2001

This device is designed to be used in Republic of Moldova

Declarație de conformitate

Noi, Continental Automotive GmbH, Siemensstrasse 12, 93055 Regensburg, Germany
(denumirea și adresa producătorului și, dacă este cazul, ale reprezentantului său autorizat care redactează declarația)

declaram pe propria noastră răspundere că produsul:

marca Continental
denumire comercială -
tip sau model 40737300

la care se referă această declarație este în conformitate cu cerințele esențiale și celelalte prevederi aplicabile ale Regulamentării tehnice "Echipamente radio, echipamente terminale de telecomunicații și recunoașterea conformității acestora", aprobată prin Hotărîrea Guvernului nr. 2 din 09.01.2014.

Produsul este în conformitate cu următoarele standarde și/sau documente normative:

Protecția sănătății [pct.7 lit.a)] EN 60950-1:2005 (2nd Edition);
Am 1:2009 + Am 2:2013
Siguranța utilizatorului [pct.7 lit.a)] EN 60950-1:2005 (2nd Edition);
Am 1:2009 + Am 2:2013
Compatibilitatea electromagnetică [pct.7 lit.b)] EN 301 489-1 V1.9.2 (2011-09)
EN 301 489-3 V1.6.1 (2013-08)
Spectrul radio [pct.8] EN 300 330-1 V1.7.1 (2010-02)
EN 300 330-2 V1.5.1 (2010-02)

Declarația de conformitate este emisă în baza
Certificat de conformitate, 18 august 2015

Organismul de evaluare a conformității antrenat MD OC TIO 024
Dosarul tehnic al echipamentului este disponibil la Continental Automotive GmbH.
Locul și data emiterii declarației Regensburg, 12.07.16

Numele (complet) al producătorului sau al persoanei autorizate Continental Automotive GmbH
Funcția (titlul) producătorului sau a persoanei autorizate Thomas Heselberger
Semnătura producătorului sau a persoanei autorizate

T. Heselberger

Moldova models

Hands-Free Telephone System



This device is designed to be used in Republic of Moldova

MINISTERUL ECONOMIEI ȘI INFRASTRUCTURII AL REPUBLICII MOLDOVA
 Instituția Publică „SERVICIUL NAȚIONAL DE MANAGEMENT AL FRECVENȚELOR RADIO ȘI SECURITĂȚII CIBERNETICE”

CERTIFICAT DE CONFORMITATE

Nr. de înregistrare **MD OC TIP 024 A6065-18**

Data emiterii: 29 martie 2018 Valabil până la: 29 martie 2021

ORGANISMUL DE CERTIFICARE OCpr - 024

Organismul de Certificare a produselor din Telecomunicații, Informatică și Poștă (OC TIP) MD-2021, str. Drumul Vilor 28/2, man. Chișinău, tel: +373 22 735394, fax: +373 22 733941

PRIN PREZENTUL DOCUMENT SE CONFIRMĂ FAPTUL CĂ PRODUSELE IDENTIFICATE AȘTEFL: DENUMIREA / DES CRIEREA

Descriere: Sistem multimedia pentru autovehicule cu modul Bluetooth și WLAN integrat

Marca comercială: MITSUBISHI

Model: NR-000

Fabricate în serie

SÎNT CONFORME CU CERINȚELE OBLIGATORII STABILITE ÎN:

SM SR EN 300 328 V1.7.1.2011; SM EN 301 893 V1.7.1.2014; SM SR EN 60950-1:2010; RT "Echipamente radio, echipamente terminale de telecomunicații și recunoașterea conformității acestora", aprobată prin HG nr.1274 din 23.11.2007; RT "Parametri tehnici de emisie și dispozitivele cu rază mică de acțiune", aprobată prin Ordinul MTC nr. 16 din 27.02.2014.

PRODUCĂTOR

Mitsubishi Electric Corporation Sanda Works,
 2-3-33 Miwa, Sanda-City, Hyogo, 669-1513, Japonia
 în urma producătoare: Mitsubishi Electric, Thai Auto-parts Co., Ltd.,
 Siam Eastern Industrial Park, 60/16 Moon 3,
 T. Maabangorn, A. Paakdaeng, Rayong - 21140 - Thailand

SOLICITANT

Mitsubishi Electric Corporation Sanda Works,
 2-3-33 Miwa, Sanda-City, Hyogo, 669-1513, Japonia

CERTIFICATUL ESTE ELIBERAT ÎN BAZA

- Raportului de încercări nr. 3828 din 29 martie 2018, eliberat de LI CEM - acreditat CNA RM "MOLDAC", certificat nr. LI-045 din 21 martie 2016, modificat din 18.12.2017.
- Raportul de încercări nr. 10706994H-F din 18.06.2015, nr. 10706994H-F, nr. 10706994H-E, nr. 10706994H-D, nr. 10706994H-C, nr. 10706994H-B, nr. 10706994H-A, nr. 10706994H-G din 24.06.2015, eliberate de LI TUL Japan, Inc., Ise EMC Lab* Japan, acreditat de NVLAP - nr. 200572-0.
- Certificatul sistemului de management al calității ISO/TS 16949:2009 nr. JPN-16812-TS (IATF nr. 022494) din 19 octombrie 2015 și nr. THA-17506/TS (IATF nr. 240942) din 15 iunie 2016, eliberat de Bureau Veritas Certification, France.
- Declarațiile de conformitate a producătorului din 29 iunie 2015.
- Raportului de evaluare final nr. 64/18 din 29 martie 2018.

INFORMAȚII SUPLEMENTARE:

Echipamentul certificat poate fi utilizat în banda de frecvențe 2400-2483,5 MHz (WLAN 2-GR2), 5150-5350 MHz (5270-5725 MHz) (WLAN 5GR2) și în banda maximă de emisie 100 mW (WLAN), 200 mW (WLAN 5150-5350 MHz), 1W (WLAN 5270-5725 MHz) Schema de câștig: Modelul F1.

Codul NM MD: 8525

Codul țării: JP

Conducătorul organismului de certificare: Anotolie CUZIN

Copilele certificatelor de conformitate se legalizează de către OC TIP - Seria A Nr. 001469

Moldova models

Hands-Free Telephone



This device is designed to be used in Republic of Moldova

MINISTERUL ECONOMIEI ȘI INFRASTRUCTURII AL REPUBLICII MOLDOVA
 Instituția Publică „SERVICIUL NAȚIONAL DE MANAGEMENT AL FRECVENTELOR RADIO ȘI SECURITĂȚII CIBERNETICE”

CERTIFICAT DE CONFORMITATE
 Nr. de înregistrare: **MD OC TIP 024 A6013-18**

MOLDAC Data emiterii: 16 ianuarie 2018 Valabil până la: 16 ianuarie 2021
EN

ORGANISMUL DE CERTIFICARE OCpr - 024

Organismul de Certificare a produselor din Telecomunicații, Informatică și Poștă (OC TIP),
 MD-2021, str. Drumul Vâlor 28/2, m.n. Chișinău, tel: +373 22 735394, fax: +373 22 733941
 PRIN PREZENTUL DOCUMENT SE CONFIRMĂ FAPTUL, CĂ PRODUSELE IDENTIFICATE AȘTEFLA
 DENUMIRE / DESCRIEREA

Descriere: Sistem multimedia pentru autovehiculele cu moduri
 Bluetooth integrat
 Marea comercială: HONDA
 Model: AVH-6968ZH
 Fabricate în serie

Codul NM MD: 8525

SÎNT CONFORME CU CERINȚELE OBLIGATORII STABILITE ÎN:
 SM SR EN 300 328 V1.7.1.2013; SM EN 60965:2015; RT "Echipamente radio,
 echipamente terminale de telecomunicații și recunoașterea conformității acestora",
 aprobată prin HG nr. 1274 din 23.11.2007; RT "Parametri tehnici de emisie ai
 dispozitivelor cu rază mică de acțiune", aprobată prin Ordinul MTC nr. 16 din 21.02.2014.

PRODUCĂTOR
 Pioneer Corporation Car Electronics Business Group,
 25-1 Aza-Nishitachi, Yamada, Kawagoe-shi, Saitama-ken 350-8555, Japan

SOLICITANT
 Pioneer Corporation,
 28-8, Honkomagome 2-chome, Bunkyo-ku, Tokyo 113-0021, Japan

CERTIFICATUL ESTE ELIBERAT ÎN BAZA
 - Raportului de încercări nr. 3782 din 02 ianuarie 2018, LI CEM - acreditat CNA RAZ "MOLDAC",
 certificat nr. LI-045 din 21 martie 2016.
 - Raportelor de încercări nr. 119331638-A și nr. 1193316398-B din 05.12.2017; nr. 119331678
 din 04.12.2017, eliberate de LI "UL, Japan Inc.", Japonia, acreditat de "JAF, Japan" - nr. RTL02610,
 - Certificatului sistemelor de management al calității - ISO 9001:2008 nr. 20102550 QM08
 din 13 mai 2015, eliberat de "UL DQS Inc.", USA acreditat de ANAB,
 - Declarației de conformitate a producătorului nr. ACE17-025 din 06 decembrie 2017.
 - Raportului de evaluare final nr. 236/17 din 12 ianuarie 2018.

INFORMAȚII SUPLEMENTARE:
 Echipamentul certificat poate fi utilizat în banda de frecvențe 2400-2483,5 MHz cu puterea maximă de emisie 100 mW.
 Schema de certificare: Modelul P1.

Codul țării: JP

Conducătorul organismului
 de certificare  Anatolie GUZUN

Completarea tuturor datelor de conformitate se legalizează de către OC TIP Seria A Nr. 001415

Moldova models

Adaptive Cruise Control (ACC)*/Adaptive Cruise Control (ACC) with Low Speed Follow (LSF)*/Collision Mitigation Braking System (CMBS)



SM EN301 091-1 V1.3.3
 SM EN301 091-2 V1.3.2
 SM EN301 489-1 V1.9.2
 SM EN301 489-3 V1.6.1
 SM EN5022:2014 p.5
 SM SR EN 60950-1:2010

Herewith we, *ROBERT BOSCH GmbH*, declare that the submitted sample **MMRevo14F** for identification and laboratory tests is a representative sample of products manufactured in series. Furthermore, we confirm that it will subsequently be imported and placed on the market in Moldova.

MINISTERUL TEHNOLOGIEI INFORMAȚIEI ȘI COMUNICAȚIILOR A. REPUBLICII MOLDOVA
 Întreprinderea de Stat „CENTRUL NAȚIONAL PENTRU FRECVENȚE RADIO”

CERTIFICAT DE CONFORMITATE

Nr. de înregistrare **MD OC TIP 024 A5958-17**
 Data emiterii: 18 octombrie 2017 Valabil până la: 18 octombrie 2020

ORGANISMUL DE CERTIFICARE OCpr - 024

Organismului de Certificare a produselor din Telecomunicații, Informatică și Poștă (OC TIP)
 MD-2021, str. Drumul Vâilor 28/2, man. Chișinău, tel:+373 22 735394, fax:+373 22 733941

PRIN PREZENTUL DOCUMENT SE CONFIRMĂ FAPTUL, CĂ PRODUSELE IDENTIFICATE ASTFEL:
 DENUMIREA / DESCRIEREA

Descriere: **Sensor radio de detecție a mișcării**
 Marca comercială: **BOSCH**
 Model: **MRRrevo14F**

Codul NM MD
8526

Fabricate în serie
 SÎNT CONFORME CU CERINȚELE OBLIGATORII STABILITE ÎN:
 SM EN 301 091-1 V1.3.3, SM EN 301 091-2 V1.3.2, SM EN 301 489-1 V1.9.2,
 SM EN 301 489-3 V1.6.1, SM EN 5022:2014 p.5, SM SR EN 60950-1:2010/RT „Echipamente
 radio, echipamente terminale de telecomunicații și recunoașterea conformității acestora”,
 aprobată prin HG nr.12/94 din 23.11.2007/ reglementarea tehnică “Parametri tehnici de emisie ai
 dispozitivelor cu rază mică de acțiune”, aprobată prin Ordinul MTIC nr. 16 din 21.02.2014.

PRODUCĂTOR

1. Robert Bosch GmbH, Markviessenstrasse 46, 72770 Reutlingen, Germany
 2. Robert Bosch Elektronika Kft., Robert Bosch ut 1, 3000 Hatvan, Hungary

SOLICITANT
Robert Bosch GmbH,
 Daimlerstr.6, Gebäude 107/1, 71229 Leonberg, Germany

CERTIFICATUL ESTE ELIBERAT ÎN BAZA

Raportului de încercări nr. 2793 din 10 septembrie 2014, eliberat de LI CEM -
 acreditat CNA RM MOLDOVA, certificați nr. LI-045 din 21 martie 2016.
 Raportului de încercări nr. 1-6938/13-01-03-A din 17.02.2014, nr. 1-6938/13-01-02
 și nr. 1-6938/13-01-06 din 09.12.2013, eliberat de LI “CETECOM ICT Services GmbH”, Germany,
 acreditat DAKS, Germany nr. 2-PL/12076-01-01.
 Certificat de conformitate IECU-CB SCHEM nr. DE 2-017370 din 20.01.2014 eliberat de
 “TUV Rheinland LGA Product GmbH”, Germany și Raportului de încercări nr. 21208925 001 (CETECOM
 1-6938/13-01-05) din 25.11.2014, eliberate de LI “CETECOM ICT Services GmbH” Germany.
 Certificatelor de Conformitate nr. E8170268-EO și nr. E8170268-CC din 27.01.2014,
 emis de Organismului Notificat “CETECOM ICT Services GmbH”, Germany nr. - 0682.
 Certificatelor sistemului de management al calității ISO/TS 16949:2009 nr. GER-16422/14-TS (IATF 234597)
 din 18 martie 2016, eliberate de “Bureau Veritas Certification”, France și nr. 070070 TS09 (IATF nr. 0273110)
 din 07.09.2017, eliberate de DQS GmbH, Germany.
 Declarația de conformitate a producătorului din 26 februarie 2014.
 Raportului de evaluare final nr. 193/7 din 17 octombrie 2017.

INFORMAȚIE SUPLEMENTARĂ:
 Echipamentul certificat poate fi utilizat în banda de frecvențe 76-77 GHz. Schema de certificare: Modulul F1.

Conducătorul organismului
 de certificare Anatolie GUZUN

Copile certificatelor de conformitate se legalizează de către OC TIP - Seria A Nr. 041831

* Not available on all models

Moldova models

Blind spot information system */Cross Traffic Monitor*



MD OC TIP 024 A5894-17

This device is designed to be used in Republic of Moldova

MINISTERUL TEHNOLOGIEI INFORMAȚIEI ȘI COMUNICĂȚILOR AL REPUBLICII MOLDOVA
Întreprinderea de Stat „CENTRUL NAȚIONAL PENTRU FRECVENȚE RADIO”

CERTIFICAT DE CONFORMITATE

Nr. de înregistrare: **MD OC TIP 024 A5894-17**
Data emiterii: 21 iulie 2017 Valabil până la: 21 iulie 2020

ORGANISMUL DE CERTIFICARE OCpr - 024

Organismul de Certificare a produselor din Telekomunicații, Informatică și Poștă (OC TIP) - MD-2021, str. Drumul Vîitor 28/2, nr.14, Chișinău, tel: +373 22 735394, fax: +373 22 733941

PRIN PREZENTUL DOCUMENT SE CONFIRMĂ FAPTUL, CĂ PRODUSELE IDENTIFICATE ASTFEL:

DENUMIREA / DESCRIEREA	Codul NM/MD
Descriere: Sensor radar pentru autovehicule	8526
Marca comercială: Autoliv	
Model: 6234734	

Fabricate în serie

SÎNTE CONFORME CU CERINȚELE OBLIGATORII STABILITE ÎN:

- SM EN 55022-2014 p.5; ERC/REC 70-03, Anexa 5; SM EN 301 489-1 V1.9.2;
- SM EN 301 489-3 V1.4.1; SM EN 60950-1:2010; Reglementarea Tehnică
- ”Echipamente radio, echipamente terminale de telecomunicații și recunoașterea conformității acestora”, aprobată prin HG nr.1274 din 23.11.2007; Reglementarea Tehnică
- ”Parametri tehnici de emisie ai dispozitivelor cu mază mică de acțiune”, aprobată prin Ordinul MTIC nr. 16 din 21.02.2014.

PRODUCĂTOR
Autoliv Electronics Canada Inc.,
7455 Birchmount Road, Markham, Ontario, L3R 5C2, Canada

SOLICITANT
Autoliv Electronics - ASP Inc.,
26545 American Drive, Southfield MI 48034, USA

CERTIFICATUL ESTE ELIBERAT ÎN BAZA

- Raportului de încercări nr. 3684 din 18 iulie 2017, LI CEM - acreditat CNA RM
- ”MOLDAC”, certificat nr. LE-045 din 21 martie 2016;
- Raportul de încercări nr. 1-4818/12-01-02 din 18.07.2012 și nr. 1-4818/12-01-03-B din 13.09.2012 eliberate de LI ”CEITECOM ICT Service GmbH” Germany, acreditat de ”Deutsche Akkreditierungstelle GmbH (DAKkS)” Germany - nr. D-PI-12076-01-01;
- Certificatul sistemului de management al calității ISO 16949:2009 nr. SGS TS-9 1214 M2 (IATF 0242442 / SGS US1080080) din 05 iulie 2016, eliberat de SGS United Kingdom Ltd., United Kingdom;
- Declarația de conformitate a producătorului din 11 septembrie 2013.
- Raportul de evaluare final nr. 94/17 din 19 iulie 2017.

INFORMAȚII SUPPLEMENTARE:
Echipamentul certificat poate fi utilizat în banda de frecvențe 24.05-24.25GHz
Schema de înregistrare: Moldova F1

Conducătorul organismului de certificare
Anatolie GUZUN

Copiile certificatelor de conformitate se legalizează de către OC TIP - Seria A Nr. 001267

Serbian models

Remote Transmitter*

Immobilizer System*



Akcionarsko društvo za ispitivanje kvaliteta "KVALITET" Niš
Акционарско друштво за испитивање квалитета "КВАЛИТЕТ" Ниш
Joint-stock company for quality testing "KVALITET" Niš



POTVRDA O USAGLAŠENOSTI - RITto Broj: **P1617162800**
CONFIRMATION OF CONFORMITY - R&TTE No.

Podnosioc zahteva: DELTA AUTOMOTO D.O.O.
Applicant: 11070 NOVI BEOGRAD
OMLADINSKIH BRIGADA 33A

Vrsta opreme: KLJUČ ZA DALJINSKI PRISTUP VOZILU
Equipment category:

Oznaka tipa/modela: HLIK6-3T
Equipment type/model:

Robna marka: Honda Lock
Equipment trademark:

Proizvođač: Honda Lock Mfg. Co., Ltd.
Manufacturer: Japan

Vrednovana dokumentacija *Evaluated documentation:*
Laboratorija/ Bezbjednost/Safety: UL Japan, Inc. Head Office EMC Lab.:
ispitni izveštaj: 10008318H, 01.07.2013. /
Laboratory/ 10008236S-C, 24.06.2013. /
Test report: EMK/EMC: UL Japan, Inc. SHONAN EMC Lab.:
10008236S-D, 21.06.2013. /
RITto/RATTE: UL Japan, Inc. SHONAN EMC Lab.:
10008236S-A, 21.06.2013. /

Na osnovu gore navedene dokumentacije utvrđeno je da gore navedena oprema zadovoljava zahtevе "Pravilnika o radio opremi i telekomunikacionoj terminalnoj opremi" (Sl. glasnik RS, 11/2012).
On the basis of the above mentioned documentation it is found that above mentioned equipment fulfills the requirements of the "Rulesbook on Radio Equipment and Telecommunications Terminal Equipment" (Official Gazette RS, 11/2012).

Nastale promene u specifikaciji, tipu/modelu, komponentama, električnim karakteristikama opreme koji utiču na usaglašenost sa navedenim Pravilnikom moraju se prijaviti "Kvalitet"u a.d. Niš.
Any changes occur in the specification, type/model, components of the design, electrical construction which may influence on conformity to the above-mentioned Rulesbook, shall be forwarded to "Kvalitet".

Prvo izdavanje Potvrde za navedenu opremu: 06.11.2010. Broj Potvrde: P1614118300

Mesto i datum izdavanja: Važi do:
Place and date: Valid until:
Niš, 02.11.2017. 01.11.2020.



Generalni direktor

Vladimir Vučkainović, dipl.inž.

Ovaj dokument važi samo za proizvode koji su izdati sa proizvođača koji su bili predmet vrednovanja.
This document is valid only for products that were the subject of the evaluation.
Bul. Svetog Cara Konstantina 82-86, Niš 18000, Srbija. Tel: (018)550-766, 550-624, Fax: (018)550-636, 550-068
e-mail: office@kvalitet.co.rs, http://www.kvalitet.co.rs



Akcionarsko društvo za ispitivanje kvaliteta "KVALITET" Niš
Акционарско друштво за испитивање квалитета "КВАЛИТЕТ" Ниш
Joint-stock company for quality testing "KVALITET" Niš



POTVRDA O USAGLAŠENOSTI - RITto Broj: **P1617162800**
CONFIRMATION OF CONFORMITY - R&TTE No.

Podnosioc zahteva: DELTA AUTOMOTO D.O.O.
Applicant: 11070 NOVI BEOGRAD
OMLADINSKIH BRIGADA 33A

Vrsta opreme: KLJUČ ZA DALJINSKI PRISTUP VOZILU
Equipment category:

Oznaka tipa/modela: HLIK6-3T
Equipment type/model:

Robna marka: Honda Lock
Equipment trademark:

Proizvođač: Honda Lock Mfg. Co., Ltd.
Manufacturer: Japan

Vrednovana dokumentacija *Evaluated documentation:*
Laboratorija/ Bezbjednost/Safety: UL Japan, Inc. Head Office EMC Lab.:
ispitni izveštaj: 10008318H, 01.07.2013. /
Laboratory/ 10008236S-C, 24.06.2013. /
Test report: EMK/EMC: UL Japan, Inc. SHONAN EMC Lab.:
10008236S-D, 21.06.2013. /
RITto/RATTE: UL Japan, Inc. SHONAN EMC Lab.:
10008236S-A, 21.06.2013. /

Na osnovu gore navedene dokumentacije utvrđeno je da gore navedena oprema zadovoljava zahtevе "Pravilnika o radio opremi i telekomunikacionoj terminalnoj opremi" (Sl. glasnik RS, 11/2012).
On the basis of the above mentioned documentation it is found that above mentioned equipment fulfills the requirements of the "Rulesbook on Radio Equipment and Telecommunications Terminal Equipment" (Official Gazette RS, 11/2012).

Nastale promene u specifikaciji, tipu/modelu, komponentama, električnim karakteristikama opreme koji utiču na usaglašenost sa navedenim Pravilnikom moraju se prijaviti "Kvalitet"u a.d. Niš.
Any changes occur in the specification, type/model, components of the design, electrical construction which may influence on conformity to the above-mentioned Rulesbook, shall be forwarded to "Kvalitet".

Prvo izdavanje Potvrde za navedenu opremu: 06.11.2010. Broj Potvrde: P1614118300

Mesto i datum izdavanja: Važi do:
Place and date: Valid until:
Niš, 02.11.2017. 01.11.2020.



Generalni direktor

Vladimir Vučkainović, dipl.inž.

Ovaj dokument važi samo za proizvode koji su izdati sa proizvođača koji su bili predmet vrednovanja.
This document is valid only for products that were the subject of the evaluation.
Bul. Svetog Cara Konstantina 82-86, Niš 18000, Srbija. Tel: (018)550-766, 550-624, Fax: (018)550-636, 550-068
e-mail: office@kvalitet.co.rs, http://www.kvalitet.co.rs

Serbian models

Keyless Access System*

Hands-Free Telephone

KVALITET Akcionarsko društvo za ispitivanje kvaliteta "KVALITET" Niš
Акционарско друштво за испитивање квалитета "КВАЛИТЕТ" Ниш
Joint-stock company for quality testing "KVALITET" Niš

POTVRDA O USAGLAŠENOSTI - RITTO Broj: P1614053800
CONFIRMATION OF CONFORMITY - R&TTE No.

Podnosilac zahteva: RTTE CONSULTING DOO
Applicant: 11000 BEOGRAD
MARICKA 28/29

Vrsta opreme: KLJUČ ZA DALJINSKI PRISTUP VOZILU
Equipment category:

Oznaka tipa/modela: V2x/V4x
Equipment type/model:

Robna marka: Continental
Equipment trademark:
Proizvođač: Continental Automotive GmbH
Manufacturer: Germany

Vrednovana dokumentacija / Evaluated documentation:
Laboratorija/ispitni izveštaj: Bezbednost/Safety: M.Duđić Hochfrequenz-Technik: 12008045, 02.11.2012./ 12008046, 02.11.2012./
Laboratory/Test report: EMK/EMC: M.Duđić Hochfrequenz-Technik: 12008044, 02.11.2012./ RITTO/R&TTE: M.Duđić Hochfrequenz-Technik: 12008042, 02.11.2012./ 12008043, 02.11.2012./

Na osnovu gore navedene dokumentacije utvrđeno je da gore navedena oprema zadovoljava zahteve "Pravilnika o radio opremi i telekomunikacionoj terminalnoj opremi" (Sl. glasnik RS, 11/2012).
On the basis of the above mentioned documentation it is found that above mentioned equipment fulfils the requirements of the "Rulebook on Radio Equipment and Telecommunications Terminal Equipment" (Official Gazette RS, 11/2012).



Nastale promene u specifikaciji, tipu/modelu, komponentama, električnim karakteristikama opreme koji utiču na usaglašenost sa navedenim Pravilnikom moraju se prijaviti "Kvalitet" u s.d. Niš.
Any changes occur in the specification, type/model, components of the design, electrical construction which may influence on conformity to the above mention Rulebook, shall be forwarded to "Kvalitet".

Mesto i datum izdavanja: Važi do:
Place and date: Valid until:
Niš, 16.05.2014. 16.05.2017.

 
Generalni direktor
Vladimir Vukosavljević, dipl.ing.

Bul. Svetog Cara Konstantina 82-86, Niš 18000, Srbija, Tel: (018)550-766, 550-624, Fax: (018)550-636, 556-068
e-mail: office@kvalitet.co.rs, http://www.kvalitet.co.rs

KVALITET Akcionarsko društvo za ispitivanje kvaliteta "KVALITET" Niš
Акционарско друштво за испитивање квалитета "КВАЛИТЕТ" Ниш
Joint-stock company for quality testing "KVALITET" Niš

POTVRDA O USAGLAŠENOSTI - RITTO Broj: P1615096100
CONFIRMATION OF CONFORMITY - R&TTE No.

Podnosilac zahteva: RTTE CONSULTING DOO
Applicant: 11000 BEOGRAD
MARICKA 28/29

Vrsta opreme: AUDIO UREDAJ ZA AUTOMOBIL
Equipment category:

Oznaka tipa/modela: NR-000
Equipment type/model:



Robna marka: MITSUBISHI
Equipment trademark:
Proizvođač: Mitsubishi Electric Corporation Sanda Works
Manufacturer: JAPAN

Vrednovana dokumentacija / Evaluated documentation:
Laboratorija/ispitni izveštaj: Bezbednost/Safety: UL Japan, Inc. Ise EMC Lab.: 10706994H-H, 18.06.2015./ / EMK/EMC: UL Japan, Inc. Ise EMC Lab.: 10706994H-G, 24.06.2015./
Laboratory/Test report: RITTO/R&TTE: UL Japan, Inc. Ise EMC Lab.: 10706994H-C, 24.06.2015./ 10706994H-E, 24.06.2015./ 10706994H-A, 24.06.2015./ 10706994H-B, 24.06.2015./ 10706994H-D, 24.06.2015./ 10706994H-F, 24.06.2015./

Na osnovu gore navedene dokumentacije utvrđeno je da gore navedena oprema zadovoljava zahteve "Pravilnika o radio opremi i telekomunikacionoj terminalnoj opremi" (Sl. glasnik RS, 11/2012).
On the basis of the above mentioned documentation it is found that above mentioned equipment fulfils the requirements of the "Rulebook on Radio Equipment and Telecommunications Terminal Equipment" (Official Gazette RS, 11/2012).

Nastale promene u specifikaciji, tipu/modelu, komponentama, električnim karakteristikama opreme koji utiču na usaglašenost sa navedenim Pravilnikom moraju se prijaviti "Kvalitet" u s.d. Niš.
Any changes occur in the specification, type/model, components of the design, electrical construction which may influence on conformity to the above mention Rulebook, shall be forwarded to "Kvalitet".

Mesto i datum izdavanja: Važi do:
Place and date: Valid until:
Niš, 11.08.2015. 11.08.2018.

 
Generalni direktor
Vladimir Vukosavljević, dipl.ing.

Bul. Svetog Cara Konstantina 82-86, Niš 18000, Srbija, Tel: (018)550-766, 550-624, Fax: (018)550-636, 556-068
e-mail: office@kvalitet.co.rs, http://www.kvalitet.co.rs

Serbian models

Hands-Free Telephone

KVALITET
 Akcionarsko društvo za ispitivanje kvaliteta "KVALITET" NIS
 Акционарско друштво за испитивање квалитета "КВАЛИТЕТ" НИШ
 Joint-stock company for quality testing "KVALITET" NIS

ATC
 АТК
 АКОДИФИКАЦИЈА
 ИСПИТИВАЊА
 NIS
 NIS 19133-13:2017

POTVRDA O USAGLAŠENOSTI - RITTO Broj: **P1617192700**
CONFIRMATION OF CONFORMITY - R&TTE No.

Podnositelj zahteva: RTTE CONSULTING DOO
Applicant: 11000 BEOGRAD-RAKOVIČA
 KNEZA VIŠESLAVA 63/2-7

Vrsta opreme: AUDIO UREĐAJ ZA AUTOMOBIL
Equipment category:

Oznaka tipa/modela: AVH-61662H
Equipment type/model:

Robna marka: HONDA
Equipment trademark:

Proizvođač: PIONEER CORPORATION
Manufacturer: JAPAN

Vrednovana dokumentacija Evaluated documentation:
Laboratorija/ Bezbednost/Safety, UL, Japan, Inc.:
ispitni izveštaj: 11933117S, 04.12.2017 /
Laboratory: EMC/EMC, UL, Japan, Inc. SHONAN EMC Lab.:
Test report: 11933118S-05, 05.12.2017 /
 RITTO&RTTE: UL, Japan, Inc. SHONAN EMC Lab.:
 11933113S-A, 05.12.2017 /

Na osnovu gore navedene dokumentacije utvrđeno je da gore navedena oprema zadovoljava zahteve "Pravilnika o radio opremi i telekomunikacionoj terminalnoj opremi" (Sl. glasnik RS, 11/2012).
 On the basis of the above mentioned documentation it is found that above mentioned equipment fulfils the requirements of the Rulebook on Radio Equipment and Telecommunications Terminal Equipment (Official Gazette RS, 11/2012).
 Nastale promene u specifikaciji, tipu/modelu, komponentama, električnim karakteristikama opreme koji utiču na usaglašenost sa navedenim Pravilnikom moraju se prijaviti "Kvalitet" u skladu sa Prilogom 1. ovog Pravilnika.
 Any changes occur in the specification, type/model, components, electrical characteristics of the equipment which may influence on conformity to the above mentioned Rulebook, shall be forwarded to "Kvalitet".

Mesto i datum izdavanja: Važi do:
Place and date: Valid until:
 Niš, 19.12.2017. 18.12.2020.

Generalni direktor
 Vladimir Vukobratović, dipl. inž.

Ova dokument važi samo za proizvode koji su izotvoreni sa proizvođača koji su bili predmet vrednovanja.
 This document is valid only for products that were manufactured by the manufacturer who was the subject of the evaluation.
 Bul. Svetog Cara Konstantina 12-86, NIŠ 18000, Srbija, Tel: (018)550-766, 550-424, Fax: (018)550-636, 550-088
 email: office@kvalitet.co.rs http://www.kvalitet.co.rs

Adaptive Cruise Control (ACC)*/Adaptive Cruise Control (ACC) with Low Speed Follow (LSF)*/Collision Mitigation Braking System (CMBS)

Република Србија
PATELA
 Републички центар за
 стандартизацију, метрологију и
 калибражирање

101-34540-31717-3
 000311320178

Број: 1-01-34540-31717-3
 Датум: 27.04.2017.
 Београд

POTVRDA O USAGLAŠENOSTI
Certificate of conformity

Број: 34540-31717-3
No:

Подносилац захтева: FIN-LEKS d.o.o. Beograd
Applicant: 11000 Београд, Милеванска 51/29

Врста опреме: Детектор кретања за примену у друском транспорту
Equipment category: у телематини у саобраћају
 Motion Detector for RTT application

Ознака марке/типа/модела: BOSCH / MRRevo14F
Equipment brand/type/model designation:

Произвођач опреме: ROBERT BOSCH GmbH
Equipment manufacturer: Daimlerstrasse 6, 71229 Leonberg, Germany

Достављена документација:
Submitted documentation:

Стандард: Standards:	Тестира извештај, број и датум: Test Report no. and date:	Назив лабораторије: Test laboratory:
SRPS EN 62479-2011	1-6938/13-01-02, 09.12.2013.	CETECOM ICT Services GmbH
SRPS EN 60950-1:2010 + A11:2010 + A1:2010 + A12:2011	21208925 001 (1-6938/13-01-05), 22.01.2014.	TÜV Rheinland LGA Product GmbH (CETECOM ICT Services GmbH)
SRPS EN 301 489-1 V1.9.2:2012	1-6938/13-01-06, 09.12.2013.	CETECOM ICT Services GmbH
SRPS EN 301 489-3 V1.6.1:2013	1-6938/13-01-02, 09.12.2013.	CETECOM ICT Services GmbH
SRPS EN 301 091-2 V1.3.2:2012	1-6938/13-01-02, 09.12.2013.	CETECOM ICT Services GmbH

Прегледом достављене, горе наведене документације, утврђено је да је услаглашеност горе наведене опреме са битним захтевима из члана 4. Правилника о радио опреми и телекомуникационој терминалној опреми („Службени гласник РС“, број 11/12) правилно доказана. Путањ одговорност за горе наведену достављену документацију преузима подносилац захтева. Овај потврда важи три године од дана издавања.
 Having considered the above mentioned submitted documentation, it has been determined that the conformity of the above mentioned equipment with the essential requirements referred to in Art. 4 of Rules on Radio Equipment and Telecommunications Terminal Equipment (Official Gazette of RS, no. 11/12) had been duly proved. The full responsibility for the above mentioned submitted documentation shall be assumed by the applicant. The certificate shall be valid three years from the date of issuance.

Број прилога: -
Appendix number:

Важи од: 30.04.2017.
Valid from:

Важи до: 30.04.2020.
Valid until:

**ДИРЕКТОР СЕКТОРА
 ЕЛЕКТРОНСКЕ КОМУНИКАЦИЈЕ**
 Војвода Јековић, дипл. инж.
 Печат и потпис
 Seal and signature

Serbian models

Blind spot information system */Cross Traffic Monitor*



This product in accordance with Serbia technical regulation



Патентна Агенција
PATEA
Техничка регулација



1403993705133
3038796470

Број: 1-01-34540-1705/13-3
Датум: 18.10.2016.
Београд

ПОТВРДА О УСАГЛАШЕНОСТИ
Certificate of conformity

Број: 34540-1705/13-3
No.

<p>Помоћница издати: RTTF Consulting d.o.o Beograd <i>Applied by:</i> RTTF Consulting d.o.o Beograd</p> <p>Врста опреме: Радар систем за преглед <i>Equipment category:</i> 3/ GHz Nonreciprocal Radar 24GHz</p> <p>Основа за издавање: Анотис / 6234734 <i>Equipment technical description:</i> Анотис / 6234734</p> <p>Произвођач опреме: Anotiv ASP Inc., <i>Equipment manufacturer:</i> 26545 American Drive, Southfield, MI 48034, USA</p>	<p>Достављача документације: <i>Submitted documentation:</i></p> <table border="1" style="width: 100%; border-collapse: collapse;"> <thead> <tr> <th style="text-align: center;">Стандарт</th> <th style="text-align: center;">Тестирање (број и датум)</th> <th style="text-align: center;">Позив лабораторије</th> </tr> </thead> <tbody> <tr> <td>SRPS EN 62159-50:0</td> <td>462-12R6 (13.06.2012)</td> <td rowspan="2">Compliance Worldwide Inc., CELECOM ICT Services GmbH</td> </tr> <tr> <td>SRPS EN 60959-1:2010 + A11:2010 + A1:2010 + A12:2011</td> <td>1-4818/13-01-03-B (13.09.2012)</td> </tr> <tr> <td>SRPS EN 601430-1 V1.0.0:2012</td> <td>1-4818/12-01-02 (18.07.2012)</td> <td rowspan="2">CELECOM ICT Services GmbH</td> </tr> <tr> <td>SRPS EN 300185-1 V1.1.1:2012</td> <td>462-12R6 (13.12.2012)</td> </tr> <tr> <td>SRPS EN 300858-2 V1.2.1:2012</td> <td>462-12R6 (13.12.2012)</td> <td>Compliance Worldwide Inc.</td> </tr> </tbody> </table>	Стандарт	Тестирање (број и датум)	Позив лабораторије	SRPS EN 62159-50:0	462-12R6 (13.06.2012)	Compliance Worldwide Inc., CELECOM ICT Services GmbH	SRPS EN 60959-1:2010 + A11:2010 + A1:2010 + A12:2011	1-4818/13-01-03-B (13.09.2012)	SRPS EN 601430-1 V1.0.0:2012	1-4818/12-01-02 (18.07.2012)	CELECOM ICT Services GmbH	SRPS EN 300185-1 V1.1.1:2012	462-12R6 (13.12.2012)	SRPS EN 300858-2 V1.2.1:2012	462-12R6 (13.12.2012)	Compliance Worldwide Inc.
Стандарт	Тестирање (број и датум)	Позив лабораторије															
SRPS EN 62159-50:0	462-12R6 (13.06.2012)	Compliance Worldwide Inc., CELECOM ICT Services GmbH															
SRPS EN 60959-1:2010 + A11:2010 + A1:2010 + A12:2011	1-4818/13-01-03-B (13.09.2012)																
SRPS EN 601430-1 V1.0.0:2012	1-4818/12-01-02 (18.07.2012)	CELECOM ICT Services GmbH															
SRPS EN 300185-1 V1.1.1:2012	462-12R6 (13.12.2012)																
SRPS EN 300858-2 V1.2.1:2012	462-12R6 (13.12.2012)	Compliance Worldwide Inc.															

Прегледом достављене, горе наведене документације, утврђено је да је усаглашеност горе наведене опреме са важећим захтевима из члана 4. Правилника о радио опреми и телекомуникационој техничкој опреми („Службени гласник РС”, број 111/12) правно доведена. Према отвореном за горе наведену достављену документацију прегледа подносилац захтева. Овај документ важи три године од дана издавања.

Having considered the above mentioned submitted documentation, it has been determined that the conformity of the above mentioned equipment with the technical requirements specified in Art. 4 of Rules on Radio Equipment and Telecommunication Technical Equipment (Official Gazette of RS, no. 111/12) has been established on the basis of submitted submitted documentation for the above mentioned submitted documentation shall be accepted by the applicant. This certificate shall be valid three years from the date of issuance.

Врлој издатила: - Милан Јанковић
Approved by: Милан Јанковић

Важи до: 18.10.2016.
Valid until: 18.10.2016.



ДИРЕКТОР
Милан Јанковић
Потпис и печат

*Продукт је одобрен за коришћење у Србији и другим земљама у складу са стандардом EN 300341:2012. Сва остала подаци су под заштитом приватности.

Serbian models

Emergency Call (eCall)

Овиме, DENSO CORPORATION изјављује да је радио опрема тип усаглашена са Директивом 2014/53/EU. Цео текст ЕУ декларације о усаглашености доступан је на следећој интернет адреси:
<https://www.denso.com/global/en/contact-us/doc/>



1-01-34540-1292/17-3
000049220184

Република Србија
PATEA
Инженерско-техничко саветовање и испитивање

Број: 1-01-34540-1292/17-3
Датум: 17.01.2018.
Београд

ПОТВРДА О УСАГЛАШЕНОСТИ
Certificate of conformity

Број: 34540-1292/17-3
No:

Подносилац захтева: SINIŠA ŠKRBIĆ PR, INŽENJERSKE DELATNOSTI
Applicant: I TEHNIČKO SAVETOVANJE IN TECH, BORČA
11211 Борча, Београд, Пут за Овчу 44

Врста опреме: GSM 900/DCS1800/ UMTS 900/2100/GPS уређај за
Equipment category: упућивање хитних позива у возилу
GSM 900 DCS1800/ UMTS 900/2100/GPS Unit Assy Ecall

Ознака марке/типа/модела: DENSO / OGEV02
Equipment brand/type/model designation:

Произвођач опреме: Denso Corporation
Equipment manufacturer: 1-1 Showa-cho, Kariya-shi, Aichi-ken, 448-8661 Japan

Достављена документација:
Submitted documentation:

Стандард: <i>Standards:</i>	Тести извештај, број и датум: <i>Test Report no. and date:</i>	Назив лабораторије: <i>Test laboratory:</i>
SRPS EN 62311:2009	RF exposure calculation of OGEV02, 13.12.2017, 11926140H-A, 07.11.2017.	Denso Corporation
SRPS EN 60950-1:2010 + A11:2010 + A1:2010 + A12:2011 + A2:2014	11926139H-C, 29.11.2017.	UL Japan, Inc. Ise EMC Lab.
SRPS EN 301 489-1 V2.1.1:2017 Draft EN 301 489-19 V2.1.0 (2017-03) Draft EN 301 489-52 V1.1.0 (2016-11)	11926139H-C, 29.11.2017.	UL Japan, Inc. Ise EMC Lab.
SRPS EN 301 511 V9.0.2:2012	ODE MJP- KYOCE_1702_02, 13.06.2017.	7 layers GmbH
SRPS EN 301 908-1 V11.1.1:20 7	REI70502C14A, 09.06.2017.	Bureau Veritas Consumer Product Services (H.K.) Ltd., Taoyuan Branch 7 layers GmbH
SRPS EN 301 908-2 V11.1.1:20 7	ODE MJP- KYOCE_1702_03, 16.06.2017.	7 layers GmbH
EN 303 413 V1.1.1 (2017-06)	11926139H-B, 10.11.2017.	UL Japan, Inc. Ise EMC Lab.

Пријемљено пријављено да се идентификује са информацијама о компатибилности са стандардом EN 15743
 Издање: 2. 11.16.8. Београд, 2018. 000049220184, Република Србија
 Контакт: центар за пријем: 011 3242 6173
 www.patea.rs

1 / 2

Serbian models

Emergency Call (eCall)

Прегледом достављене, горе наведене документације, утврђен је да је усклађеност горе наведене опреме са битним захтевима из члана 4. Правилника о радио опреми и телекомуникационој терминалној опреми („Службени гласник РС”, број 11/12) правилно доказана. Пуну одговорност за горе наведену достављену документацију преузима подносилац захтева. Ова потврда важи три године од дана издавања.

Having considered the above mentioned submitted documentation, it has been determined that the conformity of the above mentioned equipment with the essential requirements referred to in Art. 4 of Rules on Radio Equipment and Telecommunications Terminal Equipment (Official Gazette of RS, no. 11/12) had been duly proved. The full responsibility for the above mentioned submitted documentation shall be assumed by the applicant. The certificate shall be valid three years from the date of issuance.

Број прилога: -
Appendix number:

Важи од: 17.01.2018.
Valid from:

Важи до: 17.01.2021.
Valid until:



ДИРЕКТОР СЕКТОРА
ЕЛЕКТРОНСКЕ КОМУНИКАЦИЈЕ

Мирјана Ђакревић, дипл. инж.

Печат и потпис
Seal and signature

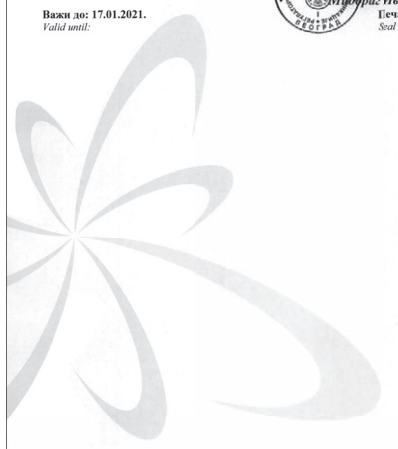

Ukrainian models

Remote Transmitter*

ДЕКЛАРАЦІЯ ПРО ВІДПОВІДНІСТЬ

ТОВ «Хонда Україна» Україна, 08132, Київська область, м. Вишневе, вул. Лесі

Українки, 73, код ЄДРПОУ 34288532)

(повне найменування виробника або уповноваженої ним особи - резидента України, або постачальника, його адреси, код згідно з ЄДРПОУ (за наявності)

в особі Директора Таку Касахара

(посада, прізвище, ім'я та по батькові уповноваженої особи)

підтверджує, що радіобладиння системи доступу до автомобіля торгової марки Honda Lock моделі HLIK6-3T (Keyless transmitter)

(повна назва пристрою, тип, марка, модель)

що виготовляється за Технічною специфікацією виробника

(назва та позначення технічної документації,

включає перші три цифри номера для ідентифікації)

на "Honda Lock Mfg. Co., Ltd." (3700 Oaza Shimonaka, Sadowara-Cho, Miyazaki-Shi, Miyazaki Pref. 880-0293, Japan / Японія) на підприємстві "Honda Lock (GuangDong) Co., Ltd." (8 GuangTian Road Xiaoan ZhongShan GuangDong, China, 528415 / Китай)

(повне найменування виробника, його адреси та номер виробничого пристрою, для вичислювального виробника від згідно ЄДРПОУ)

відповідає вимогам Технічного регламенту радіобладиння і телекомунікаційного кімнісного (термінального) обладнання, а також нормативним документам, застосованим згідно з додком відповідності пристрою вимогам зазначеного Технічного регламенту (у разі їх застосування):

Позначення пункту розділу "Вимоги до пристроїв" Технічного регламенту	Позначення нормативного документу	Назва, номер і дата акта акта акредитації випробувальної лабораторії	Номер і дата протоколу (закту) випробувань
Пункт 1 пункту 9 (безпечка)	ДСТУ ІЕС 60665:2009; ДСТУ EN 50371:2006	ВІДП ВІП "Омега" (актест акредитації №210339 від 18.05.14)	№ 14915 від 21.10.2014
Пункт 2 пункту 9 (електромеханічна сукупність)	ДСТУ ETSI EN 300 489-1:2008; ДСТУ ETSI EN 300 489-3:2009		№ 14915 від 21.10.2014
Пункт 3 пункту 9 (радіо)	ETSI EN 300 220-2 V2.3.1		№ 14915 від 21.10.2014
Пункт 4 пункту 9 (підключення до телекомунікаційної мережі загального користування)	—		—

Сертифікат, звіт або висновок (за наявності) ВИСНОВОК від 21.10.2014 № УЧН-14/D.302, Сертифікат дослідження конструкцій від 21.10.2014 № UA.TR.052.252-14

(назва документа, його номер, дата, строк дії реєстрації)

ООВ УКРЧАСТОТНАГЛЯД, 03179, м. Київ, пр-т Перемоги, 15 км, тел. (44) 422-85-44,

реєстр. номер UA.TR.052 за наказом Міністерства зв'язку України від 03.12.2012 №1381

(адреса призначеного органу з оцінки відповідності)

Оцінка відповідності пристрою проведена за процедурою дослідження конструкцій.

Декларацію складено під півкову відповідальність виробника/уповноваженої особи/постачальника (необхідне підкреслити)

Директор

(підпис)

М.П.

2014 р.

2014 р.

2014 р.

2014 р.

2014 р.

2014 р.

2014 р.

2014 р.

2014 р.

2014 р.

2014 р.

2014 р.

2014 р.

2014 р.

2014 р.

2014 р.

2014 р.

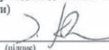

(підпис)

Таку Касахара

(підпис та прізвище)

Декларація взята ООВ УКРЧАСТОТНАГЛЯД,

на облік 03179, м. Київ, пр-т Перемоги, 15 км, тел. (44) 422-85-31,

реєстраційний номер ООВ - UA.TR.052

(повна назва призначеного органу, адреси, ідентифікаційний код реєстру призначеного ООВ)

Обліковий номер № UA.TR.052.252-14 Дата обліку 10.01.2015

(номер для позначки при реєстрації декларації про відповідність)

Керівник ООВ УКРЧАСТОТНАГЛЯД



О.Г. Лисенко

М.П.

Чинність Декларації про відповідність можна перевірити в базі даних органу з оцінки відповідності, що розміщена на <http://os.acrf.gov.ua>.

Ukrainian models

Immobilizer System*

ДЕКЛАРАЦІЯ ПРО ВІДПОВІДНІСТЬ

ТОВ «Хонда Україна» *Україна, 08132, Київська область, м. Вишневе, вул. Лесі Українки, 73, код ЄДРПОУ 34288537*

(назва найменування виробника або провайдера послуг – резидентів України, або постачальника, його адреса, код згідно ЄДРПОУ (за наявності))

в особі Директора Тавчу Касяна

(посада, прізвище, ім'я та по батькові уповноваженої особи)

підтверджує, що радіоблокування системи доступу до автомобіля торговельної марки **Honda Lock** моделі **HLK6-1R (Integrate Immobilizer System with RKE)**

(назва моделі пристрою, тип, марка, модель)

що виготовляється за Технічною специфікацією виробника

(назва та зазначення технічної документації, номер патенту чи/або сервійного номеру для ідентифікації)

на **"Honda Lock Mfg. Co., Ltd."** *(3700 Oaza Shimonaka, Sadovara-Cho, Miyazaki-Shi, Miyazaki Pref. 880-0293, Japan / Японія)* на підприємстві **"Honda Lock (GuangDong) Co., Ltd."** *(8, Guang Tian Road Xiao Lan Zhong Shan GuangDong, China 528415 / Китай)*

(назва найменування виробника, його адреса та місце виробництва продукції, для ідентифікації виробника від згідно ЄДРПОУ)

відповідає вимогам Технічного регламенту радіоблокування і телекомунікаційного кімшеного (термінального) обладнання, а також нормативним документам, застосування яких є доказом відповідності пристрою вимогам зазначеного Технічного регламенту (у разі їх застосування):

Позначення пункту розділу "Вимоги до пристроїв" Технічного регламенту	Позначення нормативного документу	Назва, номер і дата атестації виробничої випробувальної лабораторії	Номер і дата протоколу (звіт) випробувань
Підпункт 1 пункту 9 (безпека)	ДСТУ ІЕС 60065:2009; ДСТУ EN 50371:2006	ВІДПІВІ "Омега" (атестація акредитована №11339 від 18.08.14)	№ 14914 від 21.10.2014
Підпункт 2 пункту 9 (електромагнітна сумісність)	ДСТУ ЕТСІ EN 301 489-1:2008; ДСТУ ЕТСІ EN 301 489-3:2009		№ 14914 від 21.10.2014
Підпункт 3 пункту 9 (радіо)	ЕТСІ EN 300 220-2 V2.3.1; ЕТСІ EN 300 330-2 V1.5.1		№ 14914 від 21.10.2014
Підпункт 4 пункту 9 (підключення до телекомунікаційної мережі загального користування)	—		—

Сертифікат, звіт або висновок (за наявності) **ВИСНОВОК** від 21.10.2014 № УЧН-14/Д.301, Сертифікат дослідження конструкцій від 21.10.2014 № **U.A.TR.052.251-14**

(назва документа, його номер, дата, строк дії реєстрації)

ООВ УКРЧАСТОТНАГІЛД, *03179, м.Київ, пр-т Перемоги, 15 км, тел. (44) 422-85-44, реєстр. номер U.A.TR.052 за викликом Мінкомунікаційного Уряду від 03.12.2012 №1381*

(найменування та адреса провайдера послуг згідно наявності)

Оцінка відповідності пристрою проведена за процедурою дослідження конструкцій. Декларацію складено під цілковиту відповідальність виробника/уповноваженої особи/постачальника (необхідне підкреслити)

Директор

(підпис)

Тавчу Касяна
(підпис та прізвище)



Декларація взята **ООВ УКРЧАСТОТНАГІЛД**.

на об'єкт

03179, м.Київ, пр-т Перемоги, 15 км; тел. (44) 422-85-31, реєстраційний номер ООВ - U.A.TR.052

(назва провайдера послуг, адреса, ідентифікаційний код реєстру провайдера ООВ)

Обліковий номер № 10.170.052.301-14

Дата обліку 10.10.2015

(номер для позначки при реєстрації; акварильний про відповідність)

Керівник ООВ УКРЧАСТОТНАГІЛД

О. Г. Лисенко

М.П.



Чинність Декларації про відповідність можна перевірити в базі даних органу з оцінки відповідності, що розміщена на <http://os.ucrf.gov.ua>.

Ukrainian models

Keyless Access System*

ДЕКЛАРАЦІЯ № CONTINENTALUKR.679-4/15
про відповідність
"Continental Automotive GmbH", Німеччина,
(повне найменування виробника або уповноваженої ним особи - резидента України, або посольства/амбаса)
Siemensstrasse 12, D-93055 Regensburg, Germany
(адреса коз згідно з СДРР/Ю (за наявності))

в особи **Manager Dagmar Kolar**
(особа, призначена згідно з до-бюлетем уповноваженої особи)

підтверджує, що Приймопередача радіочастотний торговельної марки Continental моделі 40737300 системи дистанційного керування запуском двигуна та доступом до автомобіля
(повна назва пристрою, тип, марка, модель)

що виготовляється за **Continental 40737300 Technical Specification**
(назва та позначення технічної документації)

на (номер партії або сервісний номер для ідентифікації)
"Continental Automotive GmbH", Німеччина (Siemensstrasse 12, D-93055 Regensburg, Germany) на підприємстві "Continental Automotive Systems Czech Republic s.r.o.", 744 01 Frenstat pod Radhostem, Kopanska 1713, Czech Republic, Чеська Республіка
(повне найменування виробника, його адреса та місце виробництва продукції для власного виробника коз згідно з СДРР/Ю)

відповідає вимогам Технічного регламенту радіобезпечності і телекомунікаційного кінцевого (термінального) обладнання, а також нормативним документам, застосування яких є доказом відповідності пристрою вимогам зазначеного Технічного регламенту (у разі їх застосування):

Позначення пункту розділу "Вимоги до пристроїв" Технічного регламенту	Позначення нормативного документа	Назва, номер і дата акта акта акредитації випробувальної лабораторії	Номер і дата протоколу (звіт) випробувань
Підпункт 1 пункту 9 (безпечна)	ДСТУ 4467-1:2005		
Підпункт 2 пункту 9 (електромагнітна сумісність)	ДСТУ ETSI EN 101 489-1:2008 (з урахуванням ДСТУ ETSI EN 101 489-3:2009)	ВЦ РІТ УНДРП, м. Озеса,	4700 від 25.03.2015
Підпункт 3 пункту 9 (радіо)	ETSI EN 300 336-2 V1.5.1	2Н227 від 01.12.2014	
Підпункт 4 пункту 9 (підключення до телекомунікаційної мережі загального користування)			

Сертифікат, звіт або висновок (за наявності)
Сертифікат дослідження конструкції № 193.46-СДК від 10.04.2015;

Сертифікат відповідності № 10094.0С2716-15 від 10.04.2015, термін дії до 09.04.2020
(повна назва документа, його номер, дата, строк дії, реєстрації)

Призначений орган з оцінки відповідності ДП «Український науково-дослідний інститут радіо і телебачення» (№ UA.TR.С28), вул. Бунина, 31, м. Озеса 65056, Україна (наказ Мінекономрозвитку України № 890 від 02.08.2013).
(найменування та адреса призначеного органу з оцінки відповідності)

Оцінка відповідності пристрою проведена за процедурою "дослідження конструкції"
(позначення модуля або процесури "дослідження конструкції" відповідно до Технічного регламенту)

Декларацію складено під цілковиту відповідальність виробника / уповноваженої особи / засвідчуєльника (особлибе підкреслити)

RF Homologation  Dagmar Kolar
(підпис) (підпис) (підписи та прізвище)

М.П. "10" квітня 2015 р.
(дата)

Ukrainian models

Keyless Access System*

Додаток №1 до декларації (сводна інформація щодо оцінки відповідності продукції)

Номер сертифікату	Дата реєстрації сертифікату	Дата припинення дії сертифікату	Продукція	Вимоги у сертифікаті про відповідність	ВІС або ІСІ	Протекційне виробництво
10084.002716-15	10.04.2015	09.04.2016	Приводомедальєра радіочастотний термовантаж марку Continental моделі 8077300 системи дистанційного керування запалювання двигуна та доступу до автомобіля	Вимоги зазначені в Указі № 407 від 10.04.2015 до 09.04.2016	ВІС РСТ УЦДПР, м. Одеса	4700 від 25.03.2015

Підприємство — виробник:
"Continental Automotive Systems Czech Republic s.r.o.", 744 01 Frenstat pod Radhošem, Koprnická 1713, Czech Republic, Чеська Республіка

Manager (підпис) Dagmar Kolar (підпис та прізвище)

М.П. "10" квітня 2015 р. (місце)

ДЕКЛАРАЦІЯ № CONTINENTAL.UKR.679-3/14
про відповідність

"Continental Automotive GmbH", Німеччина,
(повне найменування виробника або уповноваженої ним особи - резидента України, або поставальника,
Siemensstrasse 12, D-93055 Regensburg, Germany
Вого адрес, код згідно з ЄДРПОУ (за наявності)
в особі **Manager Dagmar Kolar** (повне прізвище, ім'я та по-батькові уповноваженої особи)

підтверджує, що **Раціональністрій (мобільністрій) моделі V2x та V4x** (повна назва пристрою, тип, марка, модель)

що виготовляється за **Continental V2x, V4x Technical Specification** (назва та позначення технічної документації,

номер партії та/або серійні номери для ідентифікації)

на "Continental Automotive GmbH", Німеччина (Siemensstrasse 12, D-93055 Regensburg, Germany) на підприємстві "Continental Automotive Systems Czech Republic s.r.o.", 744 01 Frenstat pod Radhošem, Koprnická 1713, Czech Republic, Чеська Республіка
(повне найменування виробника, його адрес та місце виробництва продукції;
для вітчизняного виробника код згідно з ЄДРПОУ)

відповідає вимогам Технічного регламенту радіообладнання і телекомунікаційного кінцевого (термінального) обладнання, а також нормативним документам, застосування яких є доказом відповідності пристрою вимогам зазначеного Технічного регламенту (у разі їх застосування):

Позначення пункту розділу "Вимоги до пристроїв" Технічного регламенту	Позначення нормативного документа	Назва, номер і дата атестації	Назва, номер і дата протоколу акредитації виробувальної лабораторії	Ім'я і дата протоколу (зміту) випробувань
Підпункт 1 пункту 9 (безпечення)	ДСТУ 4467-1:2005	-	-	-
Підпункт 2 пункту 9 (електромагнітна сумісність)	ДСТУ ETSI EN 301 460-1:2008 (з урахуванням ДСТУ ETSI EN 301 460-3:2009)	-	ВІС РСТ УЦДПР, м. Одеса,	4130 від 12.05.2014
Підпункт 3 пункту 9 (радіо)	ДСТУ ETSI EN 300 220-2:2012, ETSI EN 300 220-2 V23.1	-	2H227 від 01.12.2011	-
Підпункт 4 пункту 9 (підключення до телекомунікаційної мережі загального користування)	-	-	-	-

Ukrainian models

Keyless Access System*

Сертифікат, звіт або висновок (за наявності)

Сертифікат дослідження конструкції № 193.37-СДК від 13.05.2014;

Сертифікат відповідності № 10094.001961-14 від 13.05.2014, термін дії до 12.05.2015

(вища документа, його номер, дата, строк дії ресурсів).

Призначений орган з оцінки відповідності ДП «Український науково-дослідний інститут радіо і телебачення» (№ УА.ТР. 028), вул. Буніна, 31, м. Одеса 65026, Україна (наказ Міністерства розвитку України № 890 від 02.08.2013).

Завантаження та адреса призначеного органу оцінки відповідності)

Оцінка відповідності пристрою проведена за процедурою "дослідження конструкції" (позначення модуля або

процедури "дослідження конструкції" відповідно до Технічного регламенту)

Декларацію складено під цілковиту відповідальність виробника / уповноваженої особи / постачальника (необхідно підкреслити)

Dagmar Kolar

Manager

(ініціали)

Dagmar Kolar

(ініціали та прізвище)

М.П.

"13" травня 2014 р.

(дата)

Додаток №1 до декларації (додаткові інформації щодо оцінки відповідності продукції)

Номер сертифікату	Дата реєстрації сертифікату	Дата закінчення дії сертифікату	Продукція	Відомості у сертифікаті про серійність	ВЦ/УГ	Протоколи випробувань
10094.001961-14	13.05.2014	12.05.2015	Радиомобільний (автомобільний) та портативний в Україні та V4x	Продукція, що випускається серійно та повністю в Україні з 13.05.2014 до 12.05.2015	ВЦ/УГ УНЦВР, м. Одеса	4130 від 12.05.2014

Підприємство — виробник:

"Continental Automotive Systems Czech Republic s.r.o.", 744 01 Frenstat pod Radhostem, Koprnicka 1713, Czech Republic, "Česka Republika"

Manager

(ініціали)

Dagmar Kolar

(ініціали та прізвище)

М.П.

"13" травня 2014 р.

(дата)

Ukrainian models

Hands-Free Telephone System

ДЕКЛАРАЦІЯ ПРО ВІДПОВІДНІСТЬ

ТОВ «Нормакон-Україна» (Україна, 72519, Запорізька обл., м. Мелітополь, вул. Кірова, 139, офіс 314, код ЄДРПОУ 37463168)

(назва виробника виробника або уповноваженої особи / реквізити особи, яка вказана в ЄДРПОУ (за наявності) в особі **Директор Шелегін О.В.**)

підтверджує, що **Комплекс автомобільний мультимедійний торговельної марки «Mitsubishi» моделі NR-000 (UNIT ASSY,AUDIO) з обладнанням радіодоступу (в тому числі з інтерфейсом передачі даних Bluetooth) та GPS** відповідає технічним характеристикам, що наведені у Додатку

що виготовляється за **Технічною специфікацією виробника** (назва та повна адреса технічного документів, номер моделі, також сервіс адреса для гарантії) на **«Mitsubishi Electric Corporation Siam Works (P-3-33, Miwa, Samba-City, Nuegoc 669-1513, Japan /Anonin) на підприємстві «Mitsubishi Electric Thai Auto-parts Co.,Ltd.» (Siam Eastern Industrial Park, 60/16 Moo 3 T.Mabyangorn, A.Pluakdaeng-21140-Rayong-Thailand / Thailand)**

(назва виробника виробника, його адрес та місце виробництва продукції, для вітчизняного виробника код згідно з ЄДРПОУ) відповідає вимогам Технічного регламенту радіоблагодання і телекомунікаційного кінцевого (термінального) обладнання, а також нормативним документам, застосування яких є доказом відповідності пристрою вимогам зазначеного Технічного регламенту (у разі їх застосування):

Позначення пункту розділу "Вимоги до пристроїв" Технічного регламенту	Позначення нормативного документа	Назва, номер і дата атестата акредитації виробничої лабораторії	Назва, номер і дата протоколу (зв'язу) виробу
Підпункт 1 пункту 9 (безпечна)	ДСТУ 4467-1:2005, ДСТУ EN 50385:2007;	ВІЛ ДПІ ВІЛ "Омега" (атестат акредитації №2НЗ39 від 18.05.14)	№15/80 від 03.04.2015
Підпункт 2 пункту 9 (електромагнітна сумісність)	ДСТУ ETSI EN 301 489-1:2008, ДСТУ ETSI EN 301 489-3:2009, ДСТУ ETSI EN 301 489-17:2008,	ВІЛ ДПІ ВІЛ "Омега" (атестат акредитації №2НЗ39 від 18.05.14)	№15/80 від 03.04.2015
Підпункт 3 пункту 9 (радіо)	ДСТУ ETSI EN 300 328:2008; ДСТУ 7115:2009; ETSI EN 300 440-2 V1.4.1.	ВІЛ ДПІ ВІЛ "Омега" (атестат акредитації №2НЗ39 від 18.05.14)	№15/80 від 03.04.2015
Підпункт 4 пункту 9 (підключення до телекомунікаційної мережі загального користування)	-	-	-

Сертифікат, звіт або висновок (за наявності) Сертифікат № UA.TR.109.0076-15 від 20.11.2015 виданий ООБ «Виробничий Центр «ОМЕГА» (03186, м. Київ, вул. Автомова, 5, офіс 714, тел. +38 041 504 5083), реєстр номер № UA.TR.109, за наказом Мінкомрозв'язу від 16.03.2015 № 267. Атестат про акредитацію НАБУ № 10293

(назва документа, його номер, дата, серія дії реєстрації, найменування та адреса приватного органу з оцінки відповідності)

Оцінка відповідності пристрою проведена за процедурою "дослідження конструкцій"

Декларацію складено під шлюнком відповідальності виробника / уповноваженої особи / постачальника (назва, прізвище, підпис)

Шелегін О.В. (підпис та прізвище)

30 листопада 2015 р. (дата)

ЕКСПЕРТИЗУ ПРОВЕДЕНО ООБ «ОМЕГА» ТОВ «ВІЛ «ОМЕГА» Завис в реєстрі від 28.11.2015 № UA.109.DC. 0274-15

Додаток до декларації про відповідність

Технічні характеристики обладнання радіодоступу у складі комплексу автомобільний мультимедійний торговельної марки «Mitsubishi» моделі NR-000 (UNIT ASSY,AUDIO):

Назва характеристики	Значення або позначення	
	стандарти IEC 802.11a/b/g/n ФКСОВАНА	стандарт IEC 802.15.1 Малошумний застосування Широкошумний радіодоступ
Служба радіо зв'язу	2400...2483,5 МГц 5150...5250 МГц 5250...5350 МГц 5470...5670 МГц 5725...5850 МГц	2400...2483,5 МГц
Радіотехнологія	Широкошумний радіодоступ	Широкошумний радіодоступ
Смуга радіочастот		
Ступінь (центральних) частот	5 МГц	1 МГц
Тип модуляції/клас випромінювання	22M0G1W 22M0D1W 40M0G1W 40M0D1W	1M00FXW, 1M00GXW
Метод радіодоступу	CSMA-CA SSMA/TDD	CSMA-CA/TDD
Еквівалентна ізотропна випромінювана потужність, не більше	20 дБм (100 мВт)	2,5 мВт
Тип антени / коефіцієнт підсилення	Інтегрована / до 6 дБі	Інтегрована / до 6 дБі



20 листопада 2015 р. (дата)

(підпис)

Шелегін О.В.

(підпис та прізвище)





ЕКСПЕРТИЗУ ПРОВЕДЕНО ООБ «ОМЕГА» ТОВ «ВІЛ «ОМЕГА» Завис в реєстрі від 28.11.2015 № UA.109.DC. 0274-15



Ukrainian models

Hands-Free Telephone System

ОРГАН З ОЦІНКИ ВІДПОВІДНОСТІ «ОМЕГА»
CONFORMITY ASSESSMENT BODY «OMEGA»

СЕРТИФІКАТ ДОСЛІДЖЕННЯ КОНСТРУКЦІЇ
RESEARCH OF DESIGN CERTIFICATE

№ 0043 Серія СД

Зареєстровано в реєстрі ООВ за № UA.TR.109.0076-15
Registered in the Record of CAU under №

Термін дії з 20 листопада 2015 р.
Term of validity is from

Сертифікат видано «Mitsubishi Electric Corporation Sanda Works», (2-3-33, Miwa, Sanda-City, Hyogo 669-1513, Japan /Японія)
Certificate is issued on

Продукція «Mitsubishi» моделі NR-000 (UNIT ASSY, AUDIO) з об'єднаним радіодоступом (в тому числі з інтерфейсом передачі даних Bluetooth) та GPS приймачем з технічними характеристиками згідно з Додатком
Production

Відповідає вимогам
Conforms with the requirements

- Технічного регламенту радіообладнання і телекомунікаційного кінцевого (термінального) обладнання;
- Узагальнених умов застосування РІ 24-1-1, РІ 24-1-2, РІ 24-1-3, РІ 24-1-4, РІ 24-2-1, РІ 24-2-2, РІ 24-2-3, РІ 24-2-4, РІ 24-3 (схвалені Рішенням НКРЗІ від 12.01.2012 №18);
- Нормативних документів наведених у Додатку

Виробник «Mitsubishi Electric Corporation Sanda Works», (2-3-33, Miwa, Sanda-City, Hyogo 669-1513, Japan /Японія)
Manufacturer

Місце виробництва «Mitsubishi Electric Thai Auto-parts Co.,Ltd.» (Siam Eastern Industrial Park, 60/16 Moo 3 T. Mubanyongra A.Pluakaeng-21140-Rayong-Thailand / Таїланд)
Place of production

Орган з оцінки відповідності «ОМЕГА», ТОВ «ВЦ «ОМЕГА»
Conformity assessment body

№ UA.TR.109, за назвою Мінекономрозвитку від 16.03.2015 № 267
Атестат про акредитацію НААУ № 10283
03186, м. Київ, вул. Антонова, 5, офіс 714, тел.: +38 044 584 5083

Підстава
The grounds

Висновок ООВ № 0076-15 від 20.11.2015 р. щодо відповідності продукції вимогам Технічного регламенту

Додаткова інформація
Additional information

Оцінка відповідності проведена за процедурою дослідження конструкції (п. 26 Технічного регламенту)



Керівник органу з оцінки відповідності
Head of the conformity assessment body

В.О. Мусов
(signature, initials, family name)

ДОДАТОК
до сертифікату дослідження конструкції
ANNEX TO RESEARCH OF DESIGN CERTIFICATE

№ 0043 Серія ДД

До сертифікату № UA.TR.109.0076-15
To certificate №

Застосовані вимоги <i>Applied requirements</i>	Нормативні документи <i>Normative documents</i>	Номер і дата протоколу випробувань (заяву про випробування) <i>Number and date of protocol of tests (statement of tests)</i>
Підпункт 1 пункту 9 Технічного регламенту радіообладнання і телекомунікаційного кінцевого (термінального) обладнання - захист апаратури і забезпечення безпеки споживача	ДСТУ 4467-1:2005, ДСТУ EN 50385:2007	Протокол випробувань №1590 від 03.04.2015 ВЦ ДП «ВЦ «Омега» (атестат акредитації №2НЗ339 від 18.05.14)
Підпункт 2 пункту 9 Технічного регламенту радіообладнання і телекомунікаційного кінцевого (термінального) обладнання - забезпечення електромагнітної сумісності	ДСТУ ETSI EN 301 489-1:2008, ДСТУ ETSI EN 301 489-3:2009, ДСТУ ETSI EN 301 489-17:2008	Протокол випробувань №1590 від 03.04.2015 ВЦ ДП «ВЦ «Омега» (атестат акредитації №2НЗ339 від 18.05.14)
Підпункт 3 пункту 9 Технічного регламенту радіообладнання і телекомунікаційного кінцевого (термінального) обладнання - забезпечення електромагнітної сумісності	ДСТУ ETSI EN 300 328:2008, ДСТУ 7115:2009, ETSI EN 300 440-2 V1 4.1, Узагальнені умови РІ 24-1-1, РІ 24-1-2, РІ 24-1-3, РІ 24-1-4, РІ 24-2-1, РІ 24-2-2, РІ 24-2-3, РІ 24-2-4, РІ 24-3 (схвалені Рішенням НКРЗІ від 12.01.2012 №18)	Протокол випробувань №1590 від 03.04.2015 ВЦ ДП «ВЦ «Омега» (атестат акредитації №2НЗ339 від 18.05.14)
Підпункт 4 пункту 9 (співзвучення до телекомунікаційної мережі загального користування)		

Склад обладнання: - комплексі автомобільні мультимедійні торговельної марки «Mitsubishi» моделі NR-000 (UNIT ASSY, AUDIO) з об'єднаним радіодоступом (в тому числі з інтерфейсом передачі даних Bluetooth) та GPS приймачем
Included parts of Equipment

Основні технічні характеристики моделі: <i>Specification</i>		
Найменування параметру <i>Technical characteristics</i>	Технічні характеристики в режимі IEEE 802.11 a/b/g/n	Опис параметру, значення або позначення
Служба радіово зв'язку		Фізична
Радіотехнологія		Широкополосний радіодоступ
Смуга радіочастот, МГц		2400 - 2483,5; 5150 - 5250; 5250 - 5350; 5470 - 5670; 5725 - 5850
Смуга (центральних) частот, МГц		5
Класи випромінювання		22M0G1W, 22M0D1W, 40M0G1W, 40M0D1W
Максимальна потужність передавача, мВт		100
Тип антени/Ga, дБі		Інтегрована / до 6
Технічні характеристики в режимі IEEE 802.15.1		
Служба радіово зв'язку		Малопотужний застосування
Радіотехнологія		Широкополосний радіодоступ
Смуга радіочастот, МГц		2400-2483,5
Смуга (центральних) частот, МГц		24
Класи випромінювання		1MPPG1W, 1MPPG3XW
EIRP, не більше, мВт		до 23
Тип антени/Ga, дБі		Інтегрована / до 6



Керівник органу з оцінки відповідності
Head of the conformity assessment body

В.О. Мусов
(signature, initials, family name)

Information

Ukrainian models

Hands-Free Telephone System

СЕРТИФІКАТ ВІДПОВІДНОСТІ
CERTIFICATE OF CONFORMITY

Зареєстровано в реєстрі органу з оцінки відповідності за № 10094.005837-18
Registered in the Register of conformity assessment body under No

Чинний від 09.03.2018
The date certification is granted

Продукція
Production

Комплекс автомобільний мультимедійний термовільної марки HONDA моделі AVH-6968ZH з обладнанням радіодіагносту (інтерфейс передачі даних Bluetooth)
Complex automobile multimedia termostatic brand HONDA model AVH-6968ZH with equipment radio diagnosis (interface data transfer Bluetooth)
(назва, марка, тип, вид, марка, торгова марка (товарний знак) / (complete product name, type, kind, model, trade name, trademark mark (trademark))

Виповнів вимогам
Complies with requirements

ДСТУ EN 60950-1:2015, ДСТУ EN 50385:2007,
ДСТУ ETSI EN 300 328-2008, ДСТУ EN 301 489-1:2014 (з урахуванням ДСТУ ETSI EN 301 489-1:2008)
(назва та позначення нормативних документів) / (name and designation of normative documents)

Виробник продукції та місце виробництва
Producer and place of production

"Pioneer Corporation", Японія (Kawagoe Plant, 25-1 Yamada, Kawagoe-shi, Saitama-ken 350-8555, Japan) та підприємства "Pioneer Manufacturing (Thailand) Co., Ltd.", Rojana Industrial Park, 1/31 Moo 5, Tambol Kanham, Amphur U-Thai, Pranarongsiyathaya 13210, Thailand, Таїланд
(найменування, адреса, код ЄДРПОУ виробника) / (name, address of manufacturer)

Сертифікат видано
Certificate is issued by

"Pioneer Corporation", Японія (Kawagoe Plant, 25-1 Yamada, Kawagoe-shi, Saitama-ken 350-8555, Japan)
(найменування, адреса, код ЄДРПОУ організацій, які видано Сертифікат) / (name, address of organization to which the Certificate was issued)

Додаткова інформація
Additional information

Продукція, що виникається серією з 09.03.2018 і реалізується з урахуванням гарантійного терміну зберігання. Умови експлуатації згідно з Додатком. Наглядання здійснюється один раз на рік з урахуванням гарантійного терміну зберігання.

Сертифікат видано органом з оцінки відповідності
Certificate is issued by the conformity assessment body

ДП "УКРАЇНСЬКИЙ НАУКОВО-ДОСЛІДНИЙ ІНСТИТУТ РАДІОТЕЛЕБІЧЕННЯ" (ОС УНДІРТ)
Адреса акредитації № 10094 69026, м. Одеса, вул. Бульвар, 31, тел.: (+48) 740 71 27, 740 71 29; факс (+48) 722 45 83, e-mail: arksolob@gmail.com

На підставі
On the grounds of

- акту експертизи документів № 2089-АЕД/17 від 06.10.2017;
- виробництва, що проведено акредитованим ЗЛ(АВ.І)

Назва АВЛ	Номер протоколу	Регістраційний номер АВЛ
ВІДПР УНДІРТ, м. Одеса	6885 від 14.12.2017	28227 від 01.12.2014

Керівник органу з оцінки відповідності
Director of the conformity assessment body

(імя, прізвище, підпис)
(signature, initials, full name)

М.П. (Stamp)

1015249

ДОДАТОК
до сертифіката відповідності
ANNEX TO CERTIFICATE OF CONFORMITY

№ 10094.005837-18

- Радіобладження, що зазначене у цьому сертифікаті відповідності, з технічними характеристиками, що наведені нижче, відповідає умовам застосування у сфері використання радіочастотного ресурсу України, від виконавчої РП 2-3 (застосує 11 до рішення НКРЗП від 12.31.2012 № 18) та експлуатації його здійснюється без оформлення дозволу УДІР (рішення НКРЗП від 23.12.2014 № 844, зареєстровано у Міністерстві України 19.02.2015 за № 201726446).
- Склад обладнання та м. HONDA:
 - комплекс автомобільний мультимедійний моделі AVH-6968ZH, з обладнанням радіодіагносту (інтерфейс передачі даних Bluetooth),
 - технічні характеристики обладнанням радіодіагносту Bluetooth:
 - радіотехнологія згідно з Планом використання широкосмугового радіодіагносту України 2400,0 ... 2483,5; 4 (2,5);
 - клас випромінювання 1M00FXW, 1M00GXW;
 - ширина смуги частот: випромінювання передавача на рівні мінус 30 дБ - контрольна, не більше, МГц 1,4;
 - тип антени / антенний підсилювач, не більше, дБІ
- Продукція виробуває і відповідає вимогам таких нормативних документів:
 - ДСТУ EN 60950-1:2015 Обладнання інформаційних технологій. Частина 1. Загальні вимоги (EN 60950-1:2006; A11:2009; A12:2011; A12:2011; A12:2011, IDT) (зі змінами за пп. 1.2.3, 1.14, 1.7);
 - ДСТУ EN 50385:2007 Радіостанції систем з радіодіагностом базової та стаціонарної кімнати. Підтвердження відповідності базовим граничним чи контрольним рівням, пов'язаним з дією радіочастотних електромагнітних полів від 110 МГц до 46 ГГц на широкій загал (EN 50385:2006, IDT);
 - ДСТУ ETSI EN 300 328:2008 Електромагнітна сумісність і радіодіагностів спектр. Системи з радіодіагностом у діапазоні частот 2,4 ГГц. Загальні вимоги до радіоінтерфейсу (ETSI EN 300 328:2006, IDT);
 - ДСТУ EN 301 489-1:2014 Електромагнітна сумісність радіобладження та радіослужб. Частина 1. Загальні технічні вимоги (EN 301 489-1:2005, IDT) (п. 8.2, 9.2, 9.3) - з урахуванням:
 - ДСТУ ETSI EN 301 489 17:2008 Електромагнітна сумісність радіобладження та радіослужб. Частина 17. Спеціальні умови для виробування широкосмугових систем передавання у смузі 2,4 ГГц, високоефективного обладнання ELAN у смузі 5 ГГц і швидкодіючих систем передавання даних у смузі 5,8 ГГц (ETSI EN 301 489-17:2002, IDT). Гарантії та послуги технічне обслуговування здійснює "Pioneer Corporation" за адресою: Kawagoe Plant, 25-1 Yamada, Kawagoe-shi, Saitama-ken 350-8555, Japan.
- Гарантії та послуги технічне обслуговування здійснює "Pioneer Corporation" за адресою: Kawagoe Plant, 25-1 Yamada, Kawagoe-shi, Saitama-ken 350-8555, Japan.

Керівник органу з оцінки відповідності
Director of the conformity assessment body

(імя, прізвище, підпис)
(signature, initials, full name)

М.П. (Stamp)

1015250

Ukrainian models

Hands-Free Telephone System

**СЕРТИФІКАТ № 2089.2-СДК
ДОСЛІДЖЕННЯ КОНСТРУКЦІЇ**

Сертифікат вийдено	ТОВ "Радо Тест Стандарти", Україна 03115, м.Київ, вул. Лавинська, 22-а, кв 135	Код ЄДРПОУ 39205151
Продукція	Комплекс автомобільний мультимедійний торговельної марки HONDA моделі АУН-6968ZH з обладнанням радіозв'язу (інтерфейс передачі даних Bluetooth)	
Виробник	"Pioneer Corporation", Японія (Kawagoe Plant, 25-1 Yamada, Kawagoe-shi, Saitama-ken 350-8555, Japan) на підприємстві згідно з Додатком № 1	
Додаткова інформація	ТОВ "Радо Тест Стандарти", Україна, діє за Довіреністю "Pioneer Corporation", Японія, від 08.09.2017	

Результати експертизи представлених документів.

№	Сфери оцінки	Результат
1	Продукція належить до сфери дії технічного регламенту радіоблокування і телекомунікаційного кімпового (термінального) обладнання (двій - ТР)	<input checked="" type="checkbox"/> Так <input type="checkbox"/> Ні
2	Нормативні документи для доведення відповідності продукції вимогам ТР правильно визначені та застосовані	<input checked="" type="checkbox"/> Так <input type="checkbox"/> Ні
3	Всі нормативні документи, що застосовані, є у "Переліку національних стандартів які в разі добровільного застосування можуть справлятися не зоклад відповідності продукції вимогам Технічного регламенту радіоблокування і телекомунікаційного кімпового (термінального) обладнання".	<input type="checkbox"/> Так <input checked="" type="checkbox"/> Ні
4	Зміст файлу технічної документації відповідає вимогам ТР	<input checked="" type="checkbox"/> Так <input type="checkbox"/> Ні
5	Протоколи випробувань підтверджують відповідність продукції вимогам ТР	<input checked="" type="checkbox"/> Так <input type="checkbox"/> Ні

За результатами експертизи встановлено, що конструкція Продукції відповідає вимогам Технічного регламенту радіоблокування і телекомунікаційного кімпового (термінального) обладнання та узгодження умов застосування у сфері використання радіочастотного ресурсу України, згідно з Додатком 11 до рішення НКРЗІ від 12.01.2012 №18.

Право застосування номеру ООВ разом зі знаком відповідності допускається за умови укладання Декларантом угоди з ООВ та щорічно підтверджується.

Виробник або уповноважена ним особа — резидент України чи нестачальник повинен зберігати комплект технічної документації, яка надавалась на експертизу, протягом 10 років після виготовлення останнього зразка продукції і подавати його для перевірки на вимогу контролюючих органів, визначених законодавством.

Якщо виробник не є резидентом України та відсутній уповноважений представник такого виробника в Україні, то нестачальник продукції, введеної в обіг, зобов'язаний забезпечити органи ринкового нагляду, за їх запитом, необхідною інформацією стосовно продукції, у тому числі копією декларацій про відповідність та, якщо це передбачено вимогами технічного регламенту, сертифікатом відповідності та/або технічною документацією щодо підтвердження відповідності технічним регламентам.

Сертифікат вийдено призначенням Органом з оцінки відповідності № UA.Т.028 ДП "Український науково-дослідний інститут радіо і телебачення" (наказ Мінсхекономрозвитку України № 890 від 02.08.2018 р.)

Керівник ООВ  А.М. Миколайчук
"09" березня 2018 р.
м.п.

015231

Цей сертифікат ООВ підлягає до запису в державний реєстр. Сертифікат ООВ не є гарантією. Вартість експертизи та оформлення документації становить 1000 грн. Вартість експертизи ООВ не входить.

Додаток № 1 до Сертифіката № 2089.2-СДК
— продукція, сертифіката відповідності, протокол випробувань, кількість продукції, ІД на продукцію:

Номер сертифікату	Чисельний код	Продукція	Відомості про серйозність	ВІС або ВІТ	Протокол(и) випробувань	Перелік ІД
10094.005837-18	09.03.2018	Комплекс автомобільний мультимедійний торговельної марки HONDA моделі АУН-6968ZH з обладнанням радіозв'язу (інтерфейс передачі даних Bluetooth)	Продукція, що випускається (сезісно з 09.03.2018)	ВІТ РТ УЦДПТ, м. Одеса	6885 від 14.12.2017	ДСТУ EN 60958-1:2015, ДСТУ EN 50185:2007, ДСТУ ЕТЗ EN 300 128:2008, ДСТУ EN 301 489-1:2014 (у тому числі ДСТУ ЕТЗ EN 301 489-17:2008)

Підприємство(а) виробник(ів):
"Pioneer Manufacturing (Thailand) Co., Ltd.", Rojana Industrial Park, 1/31 Moo5, Tambol Kanhon, Amphur U-Thai, Pranakornrajathanya 13210, Thailand, Таїланд

Керівник ООВ  А.М. Миколайчук



Information

Ukrainian models

Hands-Free Telephone System

ДЕКЛАРАЦІЯ № RTS.UKR.679-17/18
про відповідність
 "ОВ "Radio Test Стандарти", Україна,
(повне найменування виробника або уповноваженої ним особи - резидента України, або постачальника,
 03115, м.Київ, вул. Львівська, 22А, к. 135, код ЄДРПОУ 39205151
його адреса, код згідно з ЄДРПОУ (за наявності))

в особи **Директора Шумана Дмитра Володимировича,**
який діє за Довіреністю "Pioneer Corporation", Японія, від 08.09.2017
(посада, прізвище, ім'я та по-батькові уповноваженої особи)

підтверджує, Комплекс автомобільний мультимедійний торговельної марки HONDA моделі що
 AVH-6968ZH з обладнанням радіодоступу (інтерфейс передачі даних Bluetooth)
(повна назва пристрою, тип, марка, модель)

що виготовляється за **HONDA AVH-6968ZH Technical Specification**
(назва та позначення технічної документації,
 -
номер партії та/або серійні номери для ідентифікації)

на "Pioneer Corporation" Японія (Kawagoe Plant, 25-1 Yamada, Kawagoe-shi, Saitama-ken
 350-8555, Japan) на підприємстві "Pioneer Manufacturing (Thailand) Co., Ltd.", Rojana
 Industrial Park, 1/31 Moo 5, Tambol Kanham, Amphur U-Thai, Pranakomsriayuthaya
 13210, Thailand, Тайланд
(повне найменування виробника, його адреса та місце виробництва продукції,
 для визначеного виробника код згідно з ЄДРПОУ)

відповідає вимогам Технічного регламенту радіоблагодання і телекомунікаційного кінцевого
 (термінального) обладнання, а також нормативним документам, застосування яких є доказом
 відповідності пристрою вимогам зазначеного Технічного регламенту (у разі їх застосування):

Позначення пункту розділу "Вимоги до пристроїв" Технічного регламенту	Позначення нормативного документа	Назва, номер і дата аттестата акредитації виробувальної лабораторії	Номер і дата протоколу (звіту) випробувань
Підпункт 1 пункту 9 (безпека)	ДСТУ EN 60950-1:2015, ДСТУ EN 50385:2007	ВЦРПТ УНДПРТ, м. Одеса, 2Н227 від 01.12.2014	6885 від 14.12.2017
Підпункт 2 пункту 9 (електромагнітна сумісність)	ДСТУ EN 301 489-1:2014 (з урахуванням ДСТУ ETSI EN 301 489-17:2008)		
Підпункт 3 пункту 9 (радіо)	ДСТУ ETSI EN 300 328:2008		
Підпункт 4 пункту 9 (підключення до телекомунікаційної мережі загального користування)	-		



Сертифікат, звіт або висновок (за наявності):
 Сертифікат дослідження конструкцій № 2089.2-СДК від 09.03.2018
 Сертифікат відповідності № 10094.005837-18 від 09.03.2018
(назва документа, його номер, дата, строк дії реєстрації)

Призначений орган з оцінки відповідності ДП «Український науково-дослідний інститут радіо
 і телебачення» (№ УА.Т.Р. 028), вул. Бунина, 31, м. Одеса 65026, Україна (наказ
 Мінкомрозвитку України № 890 від 02.08.2013).
(найменування та адреса призначеного органу з оцінки відповідності)

Оцінка відповідності пристрою проведена за пропелуром "дослідження конструкцій"
(позначення модуля або
 провадир "дослідження конструкцій" відповідно до Технічного регламенту)
 Декларацію складено під цілковиту відповідальність виробника /
 уповноваженої особи / постачальника (необхідне підкреслити)

Директор  Д.В. Шуман
(посада) (імінь) (ініціали та прізвище)

М.П. "09" березня 2018 р.
(дата)



Ukrainian models

Hands-Free Telephone System

Додаток №1 до декларації (податкова інформація щодо оцінки відповідності продукції)

№ сертифікату	Часний віз	Продукція	Відомості про сервісність	ВЦ або ВЦ	Протокол(и) випробувань
10094.005837-18	09.03.2018	Комплекс автомобільний культурологічний торговельно-сервісний HONDA моделі АУ1-6000СІІ з обладнанням радіоапаратури (інтерфейс передачі даних Bluetooth)	Продукція, що випускається в Україні та ввозиться в Україну з 09.03.2018	ВЦ РІТ УРЕДІТ, м. Сквира	685 від 14.12.2017

Підприємство — виробник:
"Pioneer Manufacturing (Thailand) Co., Ltd.", Rojana Industrial Park, 1/31 Moo 5, Tambol Kanchan, Amphur U-Thai, Ranaakornmitayathaya 13210, Thailand, Тайланд

Директор

(посада)



(підпис)

Д.В. Шумил

(підпис та орієнтація)

М.П.

"09" березня 2018 р.

(дата)



Ukrainian models

Adaptive Cruise Control (ACC) / Adaptive Cruise Control (ACC) with Low Speed Follow (LSF) / Collision Mitigation Braking System (CMBS)

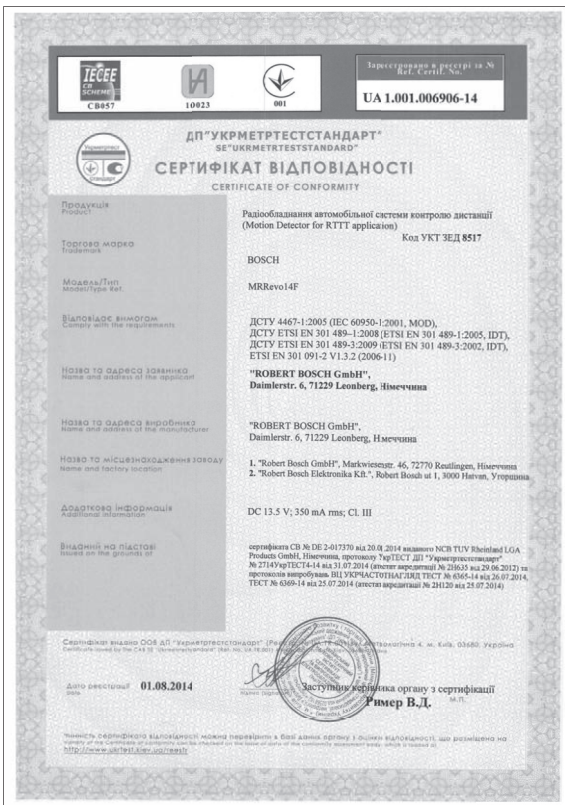

Ukrainian models

Blind spot information system*/Cross Traffic Monitor*

ДЕКЛАРАЦІЯ ПРО ВІДПОВІДНІСТЬ

"Autoliv ASP, Inc."

(лише найменування виробника або уповноваженої ним особи – резидента України, або постачальника,
26545 American Drive, Southfield MI 48034, USA/CША
Великий Каньон, місто Ілвонг у СДР1939 (за наявності))

в особі менеджера програми Патріція Кей

(посада, прізвище, ім'я та по батькові уповноваженої особи)

підтверджує, що Пристрій радіолокаційний автомобільний для безпечної перестроювання (24 GHz) SRR Narrowband моделі 6234734
(повна назва пристрою, тип, марка, модель)

що виготовляється за Process EMEA and Process Control Plan for Dial Table Line №3
(назва та повне офіційне технічне документів, номер партії та/або серійні номери для ідентифікації)

на "Autoliv Electronics America", 10118 Pawtucket Blvd., Lowell, MA 01854, USA/CША
(лише найменування виробника, його адреса та інші зареєстровані прокури), для виготовлення виробника шІСДР1939)

відповідає вимогам Технічного регламенту радіообладнання і телекомунікаційного кінцевого (термінального) обладнання, а також нормативним документам, застосування яких є доказом відповідності пристрою вимогам зазначеного Технічного регламенту (у разі їх застосування):

Позначення пункту розділу "Вимоги до пристроїв" Технічного регламенту	Позначення нормативного документу	Назва, номер і дата атестації акредитації ВЛ	Номер і дата протоколу (звіт) випробувань
Підпункт 1 пункту 9 (безпека)	ДСТУ 4467-1:2005;	ВІС	ТЕСТ № 5435-13 від 13.11.2013
Підпункт 2 пункту 9 (електронніліліпа сумісність)	ДСТУ ІЕС 61008-4-2:2008, ДСТУ ЕТСІ EN 301 489-1:2008, ДСТУ ЕТСІ EN 301 489-3:2008, ДСТУ EN 50385:2007	УКРЧАСТОТНАГЛЯД м. Київ, атестат акредитації № 2Н120 від 25.07.2011	ТЕСТ № 5258-13 від 09.10.2013
Підпункт 3 пункту 9 (радіо)	ЕТСІ EN 302 208-2 V13.2, ГОСТ 30218-95.		ТЕСТ № 5258-13 від 09.10.2013
Підпункт 4 пункту 9 (підключення до телекомунікаційної мережі загального користування)			

Сертифікат, звіт або висновок (за наявності) ВИСНОВОК № 265 від 19.11.2013
(назва документа, його номер, дата, сторінка реєстрації)

ООВ УКРЧАСТОТНАГЛЯД, 03179, м.Київ, пр-т Перемоги, 15 км, тел. (44) 422-85-44, реєстр. номер UA.TR.052 за наказом Миколаюрозв'язку України від 03.12.2012 №1381
(найменування та адреса призначеного органу з офіційною відповідальністю)

Оцінка відповідності пристрою проведена за процедурою "дослідження конструкції"

Декларацію складено під цілковиту відповідальність виробника/уповноваженої особи/постачальника (необхідно підкреслити)

Менеджер програми
(посада)



Патріція Кей
(посада та прізвище)

МП 22 листопада 2013 р.
(дата)

APPROVED NOV 22 2013

Information

Israeli models

Remote Transmitter*/Immobilizer System* Keyless Access System*

א. השימוש במכשיר הינו על בסיס "משני" ופטור מרשיון הפעלה אלחוטי.
 כלומר – לא מוגן מהפרעות וולא הפרעה למערכות אחרות הפועלות כדין.
 ב. רק "בפעולת בזק" לשימוש עצמי של הלקוח בלבד, הציוד פטור מרשיון הפעלה אלחוטי.
 מתן "שרות בזק" לצד ג' מחייב רשיון מיוחד ממשרד התקשורת.
 ג. אסור להחליף את האנטנה המקורית של המכשיר, ולא לעשות בו כל שינוי טכני אחר.

אלחוטי הפעלה מרשיון ופטור "משני" בסיס על הינו במכשיר השימוש.
 כדין הפועלות אחרות למערכות הפרעה וולא מהפרעות מוגן לא-כלומר
 אלחוטי הפעלה מרשיון פטור הציוד,בלבד הלקוח של עצמי לשימוש " בזק בפעולת" רק ב.
 התקשורת מיוחדממשרד רשיון מחייב ג' לצד "בזק שרות" מתן
 אחר טכני שינוי כל בו לעשות ולא,המכשיר של המקורית האנטנה את להחליף אסור.ג.

Hands-Free Telephone System Blind spot information system*/Cross Traffic Monitor*

א. נקודות הגישה תחת מיועדת אך ורק לחיבור משתמש המצוי בתצרים מתוחמים (דוגמת בית, בית עסק, מתחם שדה תעופה, קמפוס אוניברסיטאי וכי
 ב. לצורך גישה לאינטרנט, נקודות הגישה תקשור מחוץ לתצרים אך ורק אל בעל רישיון
 למתן שירות גישה לאינטרנט (ISP), לחלן-ספספ אינטרנט). הקישור לספספ אינטרנט יהיה
 אך ורק באמצעות קו תקשורת נתונים המסופק בידי בעל רישיון למתן שירותי תקשורת
 ג. קישור נקודת הגישה מחוץ לתצרים לצורך תקשורת נתונים ייעשה באמצעות תשתיות של
 בעל רישיון מתאים.
 ד. לצורך שרות לצד ג' נדרש רישיון נוסף מאגף הנדסה ורישוי (משרד התקשורת).

א. השימוש במכשיר פטור מרשיון הפעלה אלחוטי,
 לא מוגן מהפרעות וולא הפרעה למערכות אחרות הפועלות כדין.
 ב. רק "בפעולת בזק" לשימוש עצמי של הלקוח בלבד, הציוד פטור מרשיון הפעלה אלחוטי.
 מתן "שרות בזק" לצד ג' מחייב רשיון מיוחד ממשרד התקשורת.
 ג. אסור להחליף את האנטנה המקורית של המכשיר, ולא לעשות בו כל שינוי טכני אחר.

Adaptive Cruise Control (ACC)*/Adaptive Cruise Control (ACC) with Low Speed Follow (LSF)*/Collision Mitigation Braking System (CMBS)

10. תנאים מיוחדים והערות המשרד:
 Mid range Radar sensor for vehicles (MRR)
 לפני השיווק דיאג היבואן שעל אריזה חיצונית של המוצר יודבק מדבקה, בה יהיה רשום מס.האישור וכן:
 א. השימוש במכשיר הינו על בסיס "משני" ופטור מרשיון הפעלה אלחוטי.
 כלומר - לא מוגן מהפרעות וולא הפרעה למערכות אחרות הפועלות כדין.
 ב. רק "בפעולת בזק" לשימוש עצמי של הלקוח בלבד, הציוד פטור מרשיון הפעלה אלחוטי.
 מתן "שרות בזק" לצד ג' מחייב רשיון מיוחד ממשרד התקשורת.
 ג. אסור להחליף את האנטנה המקורית של המכשיר, ולא לעשות בו כל שינוי טכני אחר.

Moroccan models

Remote Transmitter*

AGRÉÉ PAR L'ANRT MAROC

Numero d'agrément: MR 8359 ANRT 2013

Date d'agrément: 19/07/2013

ROYAUME DU MAROC
LE ROYAL DECHENOUA

ANRT
الوكالة الوطنية لتأميم الهاتف

DIRECTION TECHNIQUE
Rabat, le 19 JUIL 2013

NR/M : ANRT/DTE/CDAA/SA/GE/ED/104/2013

CERTIFICAT D'AGRÈMENT

- Vu la Loi N° 24-99 relative à la Poste et aux Télécommunications telle qu'elle a été modifiée et complétée ;
- Vu la Décision ANRT/DGN°12/04 du 29/12/2004 fixant le régime d'agrément des équipements terminaux et des installations radioélectriques telle que complétée par la décision ANRT/DGN°06/05 du 28 juillet 2006 ;
- Vu la Décision ANRT/DGN°07/06 du 28 juillet 2006 fixant les spécifications techniques d'agrément des équipements terminaux et des installations radioélectriques elle qu'elle a été modifiée et complétée par la décision ANRT/DGN°05/06 du 22 juillet 2009 ;
- Vu la Décision ANRT/DGN°07/10 du 13 octobre 2010 fixant les conditions techniques d'utilisation des installations radioélectriques composées d'appareils de faible puissance et de faible portée (A2FP) ;
- Vu l'engagement de conformité aux spécifications techniques déclarées déposés lors de la demande.

L'ANRT décide d'accorder l'agrément à l'équipement désigné ci-dessous :

DÉSIGNATION	EMETTEUR A2FP	N° d'AGRÈMENT	MR 8359 ANRT 2013
MARQUE	HONDA LOCK	DELIVRE LE	19/07/2013
TYPE	HLIK6-3T	EXPIRE LE	18/07/2023
FABRICANT	HONDA LOCK MFG. Co.,LTD		

CARACTÉRISTIQUES TECHNIQUES :

BANDES DE FRÉQUENCES	ÉMISSION
PUISSANCE APPARENTE RAYONNÉE : -19,8 dBm	433,92 MHz

SPÉCIFICATIONS TECHNIQUES APPLICABLES :

INTERFACES SOUMISES À L'AGRÈMENT	ASPECT TÉLÉCOMMUNICATIONS	COMPATIBILITÉ ÉLECTROMAGNÉTIQUE	SÉCURITÉ ÉLECTRIQUE	EXPOSITION AUX RAYONNEMENTS ÉLECTROMAGNÉTIQUES
RADIOÉLECTRIQUE 433 MHz	ANRT-STAIR-A2FP _{19MHz}	EN 301 489-1/3	EN 60065	EN 62479 EN 62311

CONDITIONS DE COMMERCIALISATION :

- LES PERSONNES, PHYSIQUES OU MORALES, QUI SOUHAITENT COMMERCIALISER L'INTERFACE RADIOÉLECTRIQUE **A2FP** PRÉSENTE DANS LE MATÉRIEL OBJET DU PRÉSENT CERTIFICAT DOIVENT :
 - DEPOSER, AU PRÉALABLE, UNE DEMANDE AUPRÈS DE L'ANRT, ACCOMPAGNÉE D'UN ENGAGEMENT DUMENT REMPLI, CONFORMÈMENT À LA DÉCISION ANRT/DGN°07/10 SUSMENTIONNÉE.
 - TENIR À JOUR UN REGISTRE COMPORTANT LES INFORMATIONS DEMANDÉES PAR LA DITE DÉCISION.

CONDITIONS D'USAGE :

- L'UTILISATION DE L'INTERFACE RADIOÉLECTRIQUE **A2FP** PRÉSENTE DANS LE MATÉRIEL OBJET DU PRÉSENT CERTIFICAT EST LIBRE SOUS RÉSERVE DU RESPECT DES CONDITIONS D'EXPLOITATIONS PRÉCISÉES DANS LES DÉCISIONS SUSMENTIONNÉES RÉGISSANT L'USAGE DES APPAREILS DE FAIBLE PORTÉE ET FAIBLE PUISSANCE (**A2FP**) ;
- TOUTE MODIFICATION QUE SUBIT CE MATÉRIEL POSTÉRIEUREMENT À SON AGRÈMENT, NOTAMMENT AU NIVEAU DE SES CARACTÉRISTIQUES TECHNIQUES, CE MATÉRIEL DEVRA ÊTRE SOUMIS À UN NOUVEAU AGRÈMENT.
- EN CAS DE CHANGEMENT À LA RÉGLEMENTATION EN VIGUEUR, RENDANT NÉCESSAIRE D'APPORTER DES MODIFICATIONS AU PRÉSENT ÉQUIPEMENT OU À LA PROCÉDURE APPLICABLE POUR SON USAGE OU SON AGRÈMENT, VOTRE SOCIÉTÉ SERA TENUE DE S'Y CONFORMER.
- EN CAS D'INFRACTION À LA RÉGLEMENTATION EN VIGUEUR, CET AGRÈMENT PEUT ÊTRE SUSPENDU OU RETIRÉ. VOTRE SOCIÉTÉ EST PASSIBLE DES SANCTIONS PRÉVUES PAR LA RÉGLEMENTATION EN VIGUEUR.

CERTIFICAT D'AGRÈMENT ACCORDÉ À :

RASON SOCIALE : **REALTIME TELECOMMUNICATION**
 Adresse : 70, RUE MELOURYA APP1 2 AGDAL RABAT

AGENCE NATIONALE DE RÉGLEMENTATION
DES TÉLÉCOMMUNICATIONS

Centre d'offices, Bd. Ar-Rouq
Hay Riad, BP 2939, Rabat 10 100
Téléphone : (212) 5 37 71 84 00
Télécopie : (212) 5 37 30 38 62
www.anrt.ma

Abdelkrim BELKHADIR
Chef du Service

* Not available on all models

Moroccan models

Immobilizer System*

AGRÉÉ PAR L'ANRT MARO

Numero d'agrement: MR 8091ANRT 2013

Date d'agrement: 25/04/2013

ROYAUME DU MAROC
LE ROY DU MOROCCO

ANRT
الهيئة الوطنية لتنظيم المرافق
National Authority of Regulation of
Energy, Water and Telecommunications

DIRECTION TECHNIQUE
ANRT/TEC/DAA/SAG/SD/061/2013

Rabat, le 25 AVR 2013

CERTIFICAT D'AGRÈMENT

- Vu la Loi N° 24-96 RELATIVE à LA POSTE ET AUX TÉLÉCOMMUNICATIONS TELLE QU'ELLE A ÉTÉ MODIFIÉE ET COMPLÉTÉE ;
- Vu la DÉCISION ANRT/DG/N°12/04 DU 29/12/2004 FIXANT LE RÉGIME D'AGRÈMENT DES ÉQUIPEMENTS TERMINAUX ET DES INSTALLATIONS RADIOÉLECTRIQUES TELLE QU'ELLE A ÉTÉ MODIFIÉE ET COMPLÉTÉE PAR LA DÉCISION ANRT/DG/N°00/06 DU 28 JUILLET 2006 ;
- Vu la DÉCISION ANRT/DG/N°07/06 DU 28 JUILLET 2006 FIXANT LES SPÉCIFICATIONS TECHNIQUES D'AGRÈMENT DES ÉQUIPEMENTS TERMINAUX ET DES INSTALLATIONS RADIOÉLECTRIQUES TELLE QU'ELLE A ÉTÉ MODIFIÉE ET COMPLÉTÉE PAR LA DÉCISION ANRT/DG/N°09/09 DU 22 JUILLET 2009 ;
- Vu la DÉCISION ANRT/DG/N°07/10 DU 13 OCTOBRE 2010 FIXANT LES CONDITIONS TECHNIQUES D'UTILISATION DES INSTALLATIONS RADIOÉLECTRIQUES COMPOSÉES D'APPAREILS DE FAIBLE PUISSANCE ET DE FAIBLE PORTÉE (AZFP) ;
- Vu l'engagement de CONFORMITÉ AUX SPÉCIFICATIONS TECHNIQUES ÉCARTÉES DÉPOSÉ LORS DE LA DEMANDE.

L'ANRT DÉCIDE D'ACCORDER L'AGRÈMENT À L'ÉQUIPEMENT DESIGNÉ CI-DESSOUS :

DESIGNATION	ÉMETTEUR/RECEPTEUR A2FP	N° D'AGRÈMENT	MR 8091 ANRT 2013
MARQUE	HONDA LOCK	DÉLIVRÉ LE	25/04/2013
TYPE	HLIK6-1R	EXPIRE LE	24/04/2023
FABRICANT	HONDA LOCK Mfg. Co., LTD		

CARACTÉRISTIQUES TECHNIQUES :

BANDES DE FRÉQUENCES	ÉMISSION	RECEPTION
	125 KHZ	433,92 MHz
NIVEAU DE CHAMP MAGNÉTIQUE : 24,3 dBµA/m@3m		

SPÉCIFICATIONS TECHNIQUES APPLICABLES :

INTERFACES SOUMISES À L'AGRÈMENT	ASPECT TÉLÉCOMMUNICATIONS	COMPATIBILITÉ ÉLECTROMAGNÉTIQUE	SÉCURITÉ ÉLECTRIQUE	EXPOSITION AUX RAYONNEMENTS ÉLECTROMAGNÉTIQUES
RADIOÉLECTRIQUE 433,92 MHz	ANRT-STAIR-AZFP _{433,92MHz}	EN 301 489-1/3	EN 60965	EN 62479
RADIOÉLECTRIQUE 125 KHz	ANRT-STAIR-AZFP _{125KHz}			

CONDITIONS DE COMMERCIALISATION :

- LES PERSONNES PHYSIQUES OU MORALES, QUI SOUHAITENT COMMERCIALISER LE MATÉRIEL OBJET DU PRÉSENT CERTIFICAT DOIVENT :
- DÉPOSER, AU PRÉALABLE, UNE DEMANDE AUPRES DE L'ANRT, ACCOMPAGNÉE D'UN ENGAGEMENT D'ÊTRE REMPLI, CONFORMÉMENT À LA DÉCISION ANRT/DG/N°07/10 SUSMENTIONNÉE ;
- TENIR À JOUR UN REGISTRE COMPORTANT LES INFORMATIONS DEMANDÉES PAR LA DITE DÉCISION.

CONDITIONS D'USAGE :

- L'UTILISATION DU MATÉRIEL OBJET DU PRÉSENT CERTIFICAT EST LIBRE SOUS RÉSERVE DU RESPECT DES CONDITIONS D'EXPLOITATIONS PRÉCISÉES DANS LES DÉCISIONS SUSMENTIONNÉES RÉGISSANT L'USAGE DES APPAREILS DE FAIBLE PORTÉE ET FAIBLE PUISSANCE (AZFP) ;
- TOUTE MODIFICATION QUE SUBIT CE MATÉRIEL POSTÉRIEUREMENT À SON AGRÈMENT, NOTAMMENT AU NIVEAU DE SES CARACTÉRISTIQUES TECHNIQUES, CE MATÉRIEL DEVRA ÊTRE SOUMIS À UN NOUVEAU AGRÈMENT ;
- EN CAS DE CHANGEMENT À LA RÉGLEMENTATION EN VIGUEUR, RENVOYANT NECESSAIRE D'APPORTER DES MODIFICATIONS AU PRÉSENT ÉQUIPEMENT OU À LA PROCÉDURE APPLICABLE POUR SON USAGE OU SON AGRÈMENT, VOTRE SOCIÉTÉ SERA TENUE DE S'Y CONFORMER ;
- EN CAS D'INFRACTION À LA RÉGLEMENTATION EN VIGUEUR, CET AGRÈMENT PEUT ÊTRE SUSPENDU OU RETIRÉ. VOTRE SOCIÉTÉ EST PASSIBLE DES SANCTIONS PRÉVUES PAR LA RÉGLEMENTATION EN VIGUEUR.

CERTIFICAT D'AGRÈMENT ACCORDÉ À :

RAISON SOCIALE : REALTIME TELECOMMUNICATION
 ADRESSE : 70 RUE MELLOUITA, APP2, AGDAL, RABAT.

AGENCE NATIONALE DE RÉGLEMENTATION
DES TÉLÉCOMMUNICATIONS

ANRT

Abdelkarim BELKHADIR
 Chef du Service Agréments

Centre d'Affaires, 501 Av-Road,
 Hay Rad, BP: 2919, 90000 10.100
 Téléphone : (212) 5 37 91 84 00
 Télécopie : (212) 5 37 50 98 02
 www.anrt.ma

Information

* Not available on all models

Moroccan models

Keyless Access System*	Adaptive Cruise Control (ACC)*/Adaptive Cruise Control (ACC) with Low Speed Follow (LSF)*/Collision Mitigation Braking System (CMBS)
AGREE PAR L'ANRT MAROC Numéro d'agrément: MR 10385 ANRT 2015 Date d'agrément: 14/05/2015	AGREE PAR L'ANRT MAROC Numéro d'agrément: MR 9126 ANRT 2014 Date d'agrément: 2014/3/26
Hands-Free Telephone System	
AGREE PAR L'ANRT MAROC Numéro d'agrément: MR 10932 ANRT 2015 Date d'agrément: 2015/10/8	AGREE PAR L'ANRT MAROC Numéro d'agrément: MR 15382 ANRT 2017 Date d'agrément: 13/12/2017

* Not available on all models

EC Declaration of Conformity



1. The undersigned, Mr. Ryoichi Hiraki, representing the manufacturers, herewith declares that the machinery described below fulfills all the relevant provisions of:

- The EC-directive 2006/42/EC on machinery

2. Description of the machinery

a) Generic denomination: Pantograph jack
b) Function: lifting motor vehicle

c) Model	d) Type
SNB	Honda Type-A
SJD	Honda Type-B
S2A	Honda Type-C
SAH	Honda Type-D
TP6	Honda Type-G
TSA	Honda Type-I
TZV	Honda Type-J
TNY	Honda Type-K

3. Manufacturer (1) : Honda Type-A/B/C/G/I/K
RIKENKAKI CO., LTD.
5-6-12 Chiyoda Sakado-shi,
Saitama 350-0214
JAPAN

4. Manufacturer (2) : Honda Type-D/J
CHANGZHOU RIKENSEIKO MACHINERY CO., LTD.
No. 5 Xinlin Road, Zhongou Changzhou,
Jiangsu CHINA

5. Legal person authorised to compile the technical file :
Honda Motor Europe Ltd Belgium Branch
p/a Honda Motor Europe Ltd – Aalst Office
Wijngaardveld 1 (Noord V)
B-3300 Aalst, (Belgium)

6. References to harmonized standards	7. Other standards or specifications
EN1494:2000+A1:2008	-

8. Done at: Saitama, Japan
9. Date: 1 December, 2009

Ryoichi Hiraki
Ryoichi Hiraki
President of RIKENKAKI CO., LTD.
President of CHANGZHOU RIKENSEIKO
MACHINERY CO., LTD.

Note: This declaration becomes invalid, if technical or operational modifications are introduced without the manufacturers consent.

Deutsch (German)

EG-Konformitätserklärung
1. Der Unterzeichner, Herr Ryoichi Hiraki, Vertreter der Hersteller, erklärt hiermit, dass die unten beschriebenen Maschinen den relevanten Bestimmungen von folgender Richtlinie entsprechen:
•EG-Richtlinie 2006/42/EC für Maschinen
2. Beschreibung der Maschine
a) Allgemeine Bezeichnung : Scherenwagenheber
b) Funktion : Anhebung des Kraftfahrzeugs
c) Modell d) Typ
3. Hersteller (1)
4. Hersteller (2)
5. Juristische Person, die bevollmächtigt ist, die technische Datei zu erstellen
6. Bezug auf Standardübereinstimmungen
7. Andere Standards oder Spezifikationen
8. Ausgestellt in 9. Datum

Français (French)

Déclaration de conformité CE
1. Le soussigné, M. Ryoichi Hiraki, représentant les fabricants, déclare par la présente que les machines décrites ci-dessous satisfont toutes les dispositions pertinentes de:
•La Directive CE 2006/42/EC concernant les machines
2. Description des machines
a) Dénomination générique : Cric pantographe
b) Fonction : levage de véhicule à moteur
c) Modèle d) Type
3. Fabricant (1)
4. Fabricant (2)
5. Personne morale habilitée à compiler le fichier technique
6. Références aux normes harmonisées
7. Autres normes ou spécifications
8. Fait à 9. Date

Nederland (Dutch)

EG-conformiteitsverklaring
1. De ondergetekende, dhr. Ryoichi Hiraki, die de fabrikanten vertegenwoordigt, verklaart hierbij dat de hieronder beschreven machine voldoet aan alle relevante voorzieningen van:
•De EG-richtlijn 2006/42/EG voor machines
2. Beschrijving van de machine
a) Generieke benaming : Pantograafkrik
b) Functie : Motorvoertuig opheffen
c) Model d) Type
3. Fabrikant (1)
4. Fabrikant (2)
5. Rechtspersoon geautoriseerd voor de samenstelling van het technische dossier
6. Referentie geharmoniseerde normen
7. Andere normen of specificaties
8. Plaats 9. Datum

Dansk (Danish)

EF-overensstemmelseserklæring
1. Undertegnede, hr. Ryoichi Hiraki, som repræsenterer producenterne, erklærer hermed, at de herunder beskrevne maskiner overholder alle de relevante bestemmelser i:
•Maskindirektivet, EU-direktiv 2006/42/EF
2. Beskrivelse af maskinerne
a) Generiske betegnelse : Saksedonkraj
b) Funktion : Til at løfte motorkøretøj
c) Model d) Type
3. Producent (1)
4. Producent (2)
5. Juridisk person med bemyndigelse til at udarbejde den tekniske fil
6. Henvísninger til harmoniserede standarder
7. Andre standarder eller specifikationer
8. Sted 9. Dato

<p>Italiano (Italian) Dichiarazione CE di Conformità 1. Il sottoscritto, Sig. Ryoichi Hiraki, rappresentante delle fabbriche, dichiara che il veicolo sotto riportato è conforme alle disposizioni pertinenti alla: •Direttiva 2006/42/CE relative agli autoveicoli 2. Descrizione della vettura a) Denominazione generica : Martinetto a pantografo b) Funzione : sollevamento veicolo a motore c) Modello d) Tipo 3. Fabbrica (1) 4. Fabbrica (2) 5. Legale autorizzato a costituire il fascicolo tecnico 6. Riferimento norme standard 7. Altre norme e specifiche 8. Eseguito a 9. Data</p>	<p>Ελληνικά (Greek) Δήλωση Συμμόρφωσης ΕΚ 1. Ο υπογεγραμμένος, κ. Ryoichi Hiraki, ως εκπρόσωπος των κατασκευαστών, δηλώνει δια του παρόντος ότι το μηχανήμα που περιγράφεται παρακάτω πληροί όλες τις σχετικές διατάξεις της: •Κοινοτικής Οδηγίας 2006/42/ΕΚ σχετικά με μηχανήματα 2. Περιγραφή του μηχανήματος α) Συνήθης ονομασία : Γρύλος αυτοκινήτου β) Λειτουργία : Ανύψωση μηχανοκίνητων οχημάτων γ) Μοντέλο δ) Τύπος 3. Κατασκευαστής (1) 4. Κατασκευαστής (2) 5. Νομικό πρόσωπο εξουσιοδοτημένο για τη σύνταξη του τεχνικού φακέλου 6. Αναφοράς στα εναρμονισμένα πρότυπα 7. Άλλα πρότυπα ή προδιαγραφές 8. Συντάχθηκε στη 9. Ημερομηνία</p>
<p>Português (Portuguese) Declaração de Conformidade CE 1. O abaixo-assinado, Ryoichi Hiraki, representando os fabricantes através desta, declara que a maquinaria descrita abaixo cumpre todas as disposições referentes à: •Directiva 2006/42/CE, sobre máquinas. 2. Descrição da maquinaria a) Denominação genérica : Macaco de tesoura b) Função : Elevação de veículo motor c) Modelo d) Tipo 3. Fabricante (1) 4. Fabricante (2) 5. Pessoa jurídica autorizada a compilar o processo técnico 6. Referências às normas harmonizadas 7. Outras normas ou especificações 8. Elaborado em 9. Data</p>	<p>Svenska (Swedish) EG-försäkran om överensstämmelse 1. Undertecknad representant för tillverkaren, Mr. Ryoichi Hiraki, försäkrar härmed att den nedan beskrivna maskinutrustningen uppfyller alla tillämpliga bestämmelser i: •EU:s maskindirektiv 2006/42/EG 2. Beskrivning av maskinutrustning a) Generisk benämning : Saxdomkraft b) Funktion : Lyft av motorfordon c) Modell d) Typ 3. Tillverkare (1) 4. Tillverkare (2) 5. Juridisk person behörig att sammanställa den tekniska dokumentationen 6. Hänvisningar till harmoniserade normer 7. Övriga normer eller specifikationer 8. Urfärdad i 9. Datum</p>

<p>Suomi / Suomen kieli (Finnish) EY Vaatimustenmukaisuusvakuutus 1. Allekirjoittanut, Mr. Ryoichi Hiraki, valmistajän edustaja, vakuuttaa täten, että alla kuvattu laite täyttää kaikki seuraavissa säännöksissä annetut asianmukaiset velvoitteet: •Koneita koskeva EY-direktiivi 2006/42/EC 2. Laitteen kuvaus a) Yleisnimike : Saksinosturi b) Käyttötarkoitus : moottoriajoneuvon nostaminen c) Malli d) Tyyppi 3. Valmistaja (1) 4. Valmistaja (2) 5. Teknisen tiedoston kokoamiseen valtuutettu oikeushenkilö 6. Yhdenmukaistettujen standardien viitetiedot 7. Muut standardit tai tiedot 8. Paikka 9. Päiväys</p>	<p>Čeština (Czech) ES - Prohlášení o shodě 1. Niže podepsaný Ryoichi Hiraki jako zástupce výrobce, tímto prohlašuje, že uvedené strojní zařízení splňuje příslušné požadavky Směrnice evropské komise 2006/42/EC pro strojní zařízení. 2. Popis strojního zařízení a) Obecný název : nůžkový zvedák b) Funkce : zvedání motorových vozidel c) Model d) Typ 3. Výrobce (1) 4. Výrobce (2) 5. Právnícká osoba oprávněná k předložení technické dokumentace 6. Odkazy na harmonizované normy 7. Jiné normy nebo specifikace 8. Místo 9. Datum</p>
<p>Polski (Polish) Deklaracja zgodności WE 1. Niżej podpisany, Pan Ryoichi Hiraki, reprezentujący producentów, niniejszym oświadcza, że opisane poniżej urządzenie jest zgodne z wszystkimi stosownymi postanowieniami: •Dyrektywy maszynowej Wspólnoty Europejskiej 2006/42/WE 2. Opis urządzenia a) Nazwa ogólna : podnośnik nożycowy b) Przeznaczenie : podnoszenie pojazdów silnikowych c) Model d) Typ 3. Producent (1) 4. Producent (2) 5. Osoba prawna upoważniona do kompilacji dokumentacji technicznej 6. Odniesienie do zharmonizowanych norm 7. Inne normy lub specyfikacje 8. Sporządzono w 9. Data</p>	<p>Slovenčina (Slovak) ES vyhlásenie o zhode 1. Podpísaný Ryoichi Hiraki, zástupca výrobcov, týmto vyhlasuje, že nižšie opísané strojové zariadenie spĺňa všetky príslušné ustanovenia tejto smernice: •Smernica 2006/42/ES o strojových zariadeniach 2. Opis strojového zariadenia a) Generické určenie : pantografický zdvihač b) Funkcia : zdvíhanie motorových vozidiel c) Model d) Typ 3. Výrobca (1) 4. Výrobca (2) 5. Autorizovaný zástupca schopný predložiť technickú dokumentáciu 6. Odkazy na harmonizované normy 7. Iné normy alebo požiadavky 8. Miesto 9. Dátum</p>

<p>Magyar (Hungarian) EK megfelelési nyilatkozat</p> <p>1. Alulírott, Mr. Ryoichi Hiraki, a gyártók képviselőjében ezennel kijelentem, hogy az alább megnevezett gép teljesíti: *a gépekre vonatkozó 2006/42/EK irányelv összes vonatkozó előírását.</p> <p>2. A gép leírása a) Általános megnevezés : ollós emelő b) Rendeltetés : gépkocsiemelő c) Modell d) Típus 3. Gyártó (1) 4. Gyártó (2) 5. A műszaki dokumentáció összeállítására meghatalmazott jogi személy 6. Harmonizált szabványhivatkozások 7. Egyéb szabványok vagy műszaki jellemzők 8. Kiállítás helye 9. Kiállítás dátuma</p>	<p>Eesti (Estonian) EÜ vastavusdeklaratsioon</p> <p>1. Tootjate esindaja hr. Ryoichi Hiraki kinnitab käesolevaga, et allpool kirjeldatud seadmed vastavad järgmise õigusakti kõigile asjakohastele sätetele: *EÜ masinadirektiiv 2006/42/EÜ</p> <p>2. Seadmete kirjeldus a) Üldnimetus : käärtungraud b) Funktsioon : mootorsõiduki tõstmine c) Mudel d) Tüüp 3. Tootja (1) 4. Tootja (2) 5. Juriidiline isik, kes on volitatud koostama tehnilist toimetust 6. Viited harmoneeritud standarditele 7. Muud standardid ja spetsifikatsioonid 8. Koht 9. Kuupäev</p>	<p>Български (Bulgarian) ЕС декларация за съответствие</p> <p>1. Допълнителният г-н Рьоичи Хираки, представляващ производителите, декларирам с настоящата, че машината описана по-долу напълно изпълнява всички съответни разпоредби на: *Европейската директивата 2006/42/ЕС за машиностроенето</p> <p>2. Описание на машината a) Генерично наименование : Пантографен крик b) Функция : повдигане на моторни превозни средства c) Модел d) Тип 3. Производител (1) 4. Производител (2) 5. Юридическо лице, упълномощено да състави техническия файл 6. Препратки към хармонизирани стандарти 7. Други стандарти или спецификации 8. Изготвено в 9. Дата</p>	<p>Român (Romanian) Declaratie de conformitate CE</p> <p>1. Subsemnatul Ryoichi Hiraki, reprezentant al producătorilor, declar prin prezenta că utilajul descris mai jos respectă toate prevederile relevante ale: *Directivei CE 2006/42/CE referitoare la mașini</p> <p>2. Descrierea utilajului a) Denumire generică : Cric tip pantograf b) Funcție : ridicarea vehiculelor cu motor c) Model d) Tip 3. Producător (1) 4. Producător (2) 5. Persoana juridică autorizată să redacteze fișierul tehnic 6. Trimiteri la standarde armonizate 7. Alte standarde sau specificații 8. Intocmită în 9. Data</p>
<p>Latviešu (Latvian) EK paziņojums par atbilstību</p> <p>1. Zemāk parakstījis Ryoichi Hiraki, kas pārstāv ražotāju, ar šo paziņo, ka zemāk aprakstītā mašīna atbilst piemērojamām šīs direktīvas prasībām: *EK Mašīnu direktīva 2006/42/EK</p> <p>2. Mašīnas apraksts a) Vispārīgs apzīmējums : Vītnes domkrats b) Funkcija : Spēkratu celšana c) Modelis d) Tips 3. Ražotājs (1) 4. Ražotājs (2) 5. Juridiskā persona, kas pilnvarota apkopot tehnisko failu 6. Atsaucies uz harmonizētajiem standartiem 7. Citi standarti vai specifikācijas 8. Vieta 9. Laiks</p>	<p>Slovensčina (Slovenian) Izjava o skladnosti ES</p> <p>1. Podpisani g. Ryoichi Hiraki, ki zastopa proizvajalce, s tem izjavlja, da naprava, ki je opisana spodaj, izpolnjuje vse relevantne določbe: *Direktive o napravah 2006/42/ES</p> <p>2. Opis naprave a) Generično ime : Pantografski dvigalnik b) Funkcija : dvigovanje motornega vozila c) Model d) Tip 3. Proizvajalec (1) 4. Proizvajalec (2) 5. Pravna oseba, ki je upravičena do sestave tehničnega dokumenta 6. Reference glede harmoniziranih standardov 7. Drugi standardi ali specifikacije 8. Ustvarjeno v/na 9. Datum</p>	<p>Türk (Turkish) AT Uygunluk Beyanı</p> <p>1. Aşağıda imzası bulunan Sn. Ryoichi Hiraki, imalatçıları temsilen, tarif edilen makinelerin aşağıda adı geçen yönetmelihin ilgili hükümlerine uygun olduğunu beyan eder: *AT makine direktifi 2006/42/EC</p> <p>2. Makinelerin tanımı a) Jenerik adı : Pantograf krikö b) İşlevi : motorlu taşıtları kaldırma c) Model d) Tür 3. İmalatçı (1) 4. İmalatçı (2) 5. Teknik dosyayı düzenlemeye yetkili tüzel kişi 6. Uymlaştırılmış standartlara atıflar 7. Diğer standartlar ya da şartnameler 8. Düzenlendiği yer 9. Tarih</p>	<p>Íslenska (Icelandic) EB-samræmisýrfrýsing</p> <p>1. Undirritaður, herra Ryoichi Hiraki, fulltrúi framleiðanda, lýsir yfir að vélbúnaðinum, sem lýst er hér að neðan, uppfyllir öll viðeigandi ákvæði: *EB-litiskipunarinnar 2006/42/EC um vélbúnað</p> <p>2. Lýsing á vélbúnaðinum a) Almenn heiti : Tviarma tjakkur b) Hlutverk : að lyfta vélknúnum ökutækjum c) Gerð d) Tegund 3. Framleiðandi (1) 4. Framleiðandi (2) 5. Lögaðli sem hefur heimild að taka saman tækniskjal 6. Tilvísanir í samhæfða staðla 7. Aðrir staðlar eða tæknilysingar 8. Staður 9. Dagsetning</p>

<p>Español (Spanish) Declaración de Conformidad CE</p> <p>1. El abajo firmante, Sr. Ryoichi Hiraki, en representación de los fabricantes, por la presente declara que la maquinaria descrita a continuación cumple con las disposiciones aplicables de:</p> <p>•La directiva 2006/42/CE relativa a maquinarias</p> <p>2. Descripción de la maquinaria</p> <p>a) Denominación genérica : Gato pantográfico</p> <p>b) Función : Elevación de vehículo automotor</p> <p>c) Modelo d) Tipo</p> <p>3. Fabricante (1)</p> <p>4. Fabricante (2)</p> <p>5. Persona jurídica autorizada para recopilar el archivo técnico</p> <p>6. Referencias de normas armonizadas</p> <p>7. Otras normas o especificaciones</p> <p>8. Elaborada en 9. Fecha</p>	<p>Norsk (Norwegian) EF-samsvarserklæring</p> <p>1. Undertegnede, Ryoichi Hiraki, som representerer produsentene, erklærer herved at maskinen beskrevet nedenfor oppfyller alle relevante bestemmelser i:</p> <p>•EU-maskindirektiv 2006/42/EU</p> <p>2. Beskrivelse av maskineriet</p> <p>a) Generisk betegnelse : Pantografjekk (biljekk)</p> <p>b) Funksjon : løfting av motorkjøretøyer</p> <p>c) Modell d) Type</p> <p>3. Produsent (1)</p> <p>4. Produsent (2)</p> <p>5. Juridisk person med fullmakt til å utarbeide den tekniske dokumentasjonen</p> <p>6. Henvisninger til harmoniserte standarder</p> <p>7. Andre standarder eller spesifikasjoner</p> <p>8. Utarbeidet i 9. Dato</p>
<p>Lietuvių kalba (Lithuanian) EB atitikties deklaracija</p> <p>1. Toliau pasirašęs gamintojų atstovas Ryoichi Hiraki deklaruoja, kad toliau aprašytoji įranga atitinka visas atitinkamas nuostatas, išdėstytas:</p> <p>•EB Direktyvoje 2006/42/EB dėl mašinų</p> <p>2. Įrangos aprašymas</p> <p>a) Bendras pavadinimas : pantografo kėliklis</p> <p>b) Funkcija : motorinės transporto priemonės kėlimas</p> <p>c) Modelis d) Tipas</p> <p>3. Gamintojas (1)</p> <p>4. Gamintojas (2)</p> <p>5. Juridinis asmuo, įgaliotas sudaryti techninę bylą</p> <p>6. Nuoroda į lygiavertis standartus</p> <p>7. Kiti standartai arba specifikacijos</p> <p>8. Atlikta 9. Data</p>	<p>Hrvatski (Croatian) Izjava o sukladnosti EK</p> <p>1. Ja, dolje potpisani Ryoichi Hiraki, predstavnik proizvođača, ovime izjavljujem da su strojevi opisani u nastavku sukladni s bitnim odredbama:</p> <p>•Direktive 2006/42/EZ Europskog parlamenta i vijeća o strojevima</p> <p>2. Opis stroja</p> <p>a) Generički naziv : pantografska dizalica</p> <p>b) Funkcija : podizanje motornog vozila</p> <p>c) Model d) Tip</p> <p>3. Proizvođač (1)</p> <p>4. Proizvođač (2)</p> <p>5. Pravna osoba ovlaštena za sastavljanje tehničke dokumentacije</p> <p>6. Upućivanje na usklađene norme</p> <p>7. Ostale norme ili specifikacije</p> <p>8. Mjesto 9. Datum</p>

Numbers

4WD	550
7-Speed Manual Shift Mode	525

A

ABS (Anti-lock Brake System)	637
ACC (Adaptive Cruise Control)	589
Accessories and Modifications	728
Accessory Power Sockets	280
Adaptive Cruise Control (ACC)	589
Adaptive Cruise Control (ACC) with Low Speed Follow (LSF)	572
Adding	
Coolant	687
Engine Oil	686
Washer	692
Additives, Engine Oil	683
Adjustable Speed Limiter	536
Adjusting	
Armrest	267
Front Seats	249
Head Restraints	262, 264
Mirrors	245
Steering Wheel	244
Temperature	151
Adjusting the Sound	311, 354
Agile Handling Assist	549
Aha™	374

Air Conditioning System (Climate Control System)	290
Changing the Mode	292
Defrosting the Windscreen and Windows	293
Dust and Pollen Filter	721
Recirculation/Fresh Air Mode	292
Sensor	296
Synchronization Mode	295
Using Automatic Climate Control	290
Air Pressure	771
Airbags	56
After a Collision	59
Airbag Care	69
Event Data Recorder	1
Front Airbags (SRS)	58
Indicator	67, 104
Passenger Airbag Off Indicator	68
Sensors	56
Side Airbag	63
Side Curtain Airbag	65
All-Wheel Drive (AWD) System	550
AM/FM Radio	314, 361
Android Auto	394
Anti-lock Brake System (ABS)	637
Indicator	103
Apple CarPlay	390
Armrest	267
Audio Remote Controls	302

Audio System	298, 305, 332
Adjusting the Sound	311, 354
Audio/Information Screen	307, 333
Changing the Home Screen Icon Layout ..	337
Changing the Screen Interface	351
Closing Apps	353
Customizing the Meter	337
Display Setup	313, 355
Error Messages	398
General Information	400
HDMI™ Port	300
Home Screen	343
iPod	323, 367
Menu Customize	352
MP3/WMA/AAC	326, 375
Reactivating	301
Recommended Devices	400
Remote Controls	302
Security Code	301
Selecting an Audio Source	356
Status Area	350
Theft Protection	301
USB Flash Drives	326, 375, 400
USB Port(s)	299
Wallpaper Setup	309, 341
Audio System Basic Operation	305, 332
Audio/Information Screen	307, 333
Auto High-Beam	
Auto High-Beam Indicator	108

Auto High-Beam (High Beam Support System).....	229
Auto Idle Stop.....	532
Auto Idle Stop Indicator (Green).....	112
Auto Idle Stop System Indicator (Amber).....	112
Automatic Brake Hold.....	634
Indicator.....	634
Automatic Folding Door Mirror Function.....	248
Automatic Intermittent Wipers.....	234
Automatic Lighting.....	224
Average Fuel Economy.....	150
Average Speed.....	150
AWD (All-Wheel Drive).....	550

B

Battery.....	712
Charging System Indicator.....	102, 751
Jump Starting.....	746
Maintenance (Checking the Battery).....	712
Maintenance (Replacing).....	715
Belts (Seat).....	43
Beverage Holders.....	278
Blind spot information System.....	555
Blind spot information System Indicator.....	121
Bluetooth® Audio.....	329, 378
Booster Seats (For Children).....	92

Brake System.....	629
Anti-lock Brake System (ABS).....	637
Automatic Brake Hold.....	634
Brake Assist System.....	638
Fluid.....	691
Foot Brake.....	633
Indicator.....	98, 100, 753, 754
Parking Brake.....	629
Brightness Control (Head-up Display).....	238
Brightness Control (Instrument Panel)....	237
Bulb Replacement.....	694
Active Cornering Lights.....	697
Back-Up Lights.....	698
Brake Lights.....	697
Daytime Running Lights.....	697
Front Fog Lights.....	695
Front Turn Signal Lights.....	697
Glove Box Light.....	701
Headlights.....	694
High-Mount Brake Light.....	699
Luggage Area Light.....	700
Position Lights.....	697
Rear Fog Light.....	699
Rear Licence Plate Light.....	699
Rear Turn Signal Lights.....	697
Side Turn Signal/Emergency Indicator Lights.....	697
Taillights.....	697, 698
Vanity Mirror Lights.....	700
Bulb Specifications.....	770

C

Carbon Monoxide Gas.....	94
Carrying Luggage.....	501, 503
Certification Label.....	773
Changing Bulbs.....	694
Charging System Indicator.....	102, 751
Child Restraint System.....	70
Booster Seats.....	92
Child Restraint System for Infants.....	73
Child Restraint System for Small Children..	75
Installing a Child Restraint System with a Lap/Shoulder Seat Belt.....	88
Larger Children.....	91
Rear-facing Child Restraint System.....	73
Selecting a Child Restraint System.....	76
Using Tether.....	90
Child Safety.....	70
Childproof Door Locks.....	191
Childproof Door Locks.....	191
Cleaning the Exterior.....	725
Cleaning the Interior.....	723
Climate Control System.....	290
Changing the Mode.....	290
Defrosting the Windscreen and Windows.....	293
Dust and Pollen Filter.....	721
Recirculation/Fresh Air Mode.....	292
Sensors.....	296
Synchronization Mode.....	295
Using Automatic Climate Control.....	290

Clock.....	176
CMBS (Collision Mitigation Braking System).....	561
Coat Hook.....	282
Collision Mitigation Braking System (CMBS).....	561
Continuously Variable Transmission.....	522
7-Speed Manual Shift Mode.....	525
Creeping.....	522
Fluid.....	690
Kickdown.....	522
Operating the Shift Lever.....	524
Shift Lever Does Not Move.....	748
Shifting.....	523
Controls.....	175
Coolant (Engine).....	687
Adding to the Reserve Tank.....	687
Overheating.....	749
Creeping (Continuously Variable Transmission).....	522
Cross Traffic Monitor.....	646
Customized Features.....	158, 405, 413

D

DAB.....	320, 364
Daytime Running Lights.....	232
Dead Battery.....	746
Defaulting All the Settings.....	440

Deflation Warning System.....	551
Indicator.....	107, 756
Initialisation.....	551
Defrosting the Windscreen and Windows.....	293
Devices that Emit Radio Waves.....	774
Dimming.....	
Headlights.....	223
Rearview Mirror.....	245
Dipstick (Engine Oil).....	685
Directional Signals (Turn Signals).....	222
Display Setup.....	313, 355
Display/Information Button.....	148, 333
Door Mirrors.....	246
Doors.....	179
Door Open Indicator.....	42
Keys.....	179
Locking/Unlocking the Doors from the Inside.....	189
Locking/Unlocking the Doors from the Outside.....	182
Lockout Prevention System.....	188
Driver Information Interface.....	148
Driver's Seat Lumbar Support.....	250
Driving.....	499
Braking.....	629
Continuously Variable Transmission.....	522
Shifting Gear.....	523, 528
Starting the Engine.....	514, 517

Driving Guidelines for Your Utility Vehicle.....	520
Driving Position Memory System.....	242
Dust and Pollen Filter.....	721

E

EC Declaration of Conformity Content Outline.....	806
eCall Indicator.....	493
Eco Assist System.....	11
ECON Mode.....	531
Elapsed Time.....	150
Electric Power Steering (EPS) System Indicator.....	106, 755
Emergency.....	765
Emergency Call (eCall).....	493
Automatic Emergency Call.....	493
Manual Emergency Call.....	495
Emergency Stop Signal.....	639
Engine.....	
Coolant.....	687
Jump Starting.....	746
Number.....	773
Oil.....	683
Starting.....	514, 517
Switch Buzzer.....	217, 220
Engine Coolant.....	687
Adding to the Reserve Tank.....	687
Overheating.....	749

Engine Oil.....	683
Adding	686
Checking	685
Low Oil Level Indicator	757
Low Oil Pressure Indicator.....	101, 751
Recommended Engine Oil.....	683
ENGINE START/STOP Button.....	218
e-pretensioners	48
EPS (Electric Power Steering) System.....	106
Exhaust Hazard (Carbon Monoxide).....	94
Exterior Care (Cleaning)	725
Exterior Mirrors.....	246
F	
Features	297
Filter	
Dust and Pollen.....	721
Flat Tyre.....	734
Fluids	
Brake/Clutch	691
Continuously Variable Transmission	690
Engine Coolant.....	687
Manual Transmission	690
Windscreen Washer	692
FM/AM Radio	314, 361
Folding Down the Second Row	
Seats.....	255, 257
Folding Down the Third Row Seat.....	261
Foot Brake.....	633
Four-Wheel Drive System	550

Front Airbags (SRS).....	58
Front Fog Light Indicator	109
Front Seat Heaters	286
Front Seats	249
Adjusting.....	249
Front Sensor Camera	626
Fuel.....	653
Economy and CO ₂ Emissions.....	655
Gauge	147
Instant Fuel Economy.....	151
Low Fuel Indicator	103
Range.....	150
Recommendation	653
Refueling	653
Fuel Economy and CO ₂ Emissions	655
Fuel Fill Cap.....	28, 654
Fuel Fill Door.....	28, 654
Fuses	758
Inspecting and Changing.....	764
Locations.....	758, 760

G	
Gauges	147
Gear Shift Lever Positions	
Continuously Variable Transmission	523
Manual Transmission	528
Glass (care).....	724, 726
Glove Box	272

H

Hands-Free Telephone (HFT)	441, 462
Automatic Import of Cellular Phonebook and Call History.....	474
HFT Buttons	441, 462
HFT Menus.....	443, 465
HFT Status Display	442, 464
Limitations for Manual Operation	442, 464
Making a Call.....	457, 482
Options During a Call	461, 486
Phone Setup.....	447, 469
Receiving a Call	460, 485
Ring Tone.....	452, 473
Speed Dial.....	455, 475
Hands-Free Telephone (HFT) System	
Displaying Messages.....	489
Phonebook Phonetic Modification	478
Receiving a Text Message/E-mail.....	487
Selecting a Mail Account	488
To Set Up Text Message/E-mail Options...	472
HandsFreeLink® (HFL)	
Displaying Messages.....	489
Phonebook Phonetic Modification	478
Receiving a Text Message/E-mail.....	487
Selecting a Mail Account.....	488
To Set Up Text Message/E-mail Options...	472
Hazard Warning Button	4, 5
HDMI™ Port.....	300
Head Restraints	262, 264
Headlight Washers	236

Headlights	223	Indicators	98	M (7-speed manual shift mode) Indicator/ Shift	102
Aiming	694	Adaptive Cruise Control (ACC) and Intelligent Speed Limiter Set Speed	113	Malfunction Indicator Lamp	101, 752
Auto High-Beam (High Beam Support System).....	229	Adaptive Cruise Control (ACC) with Low Speed Follow (LSF)	117, 572	Parking Brake and Brake System (Amber)	100, 754
Automatic Operation	224	Adjustable Speed Limiter	113	Parking Brake and Brake System (Red)	98, 753, 754
Dimming	223	Anti-lock Brake System (ABS).....	103	Passenger Front Airbag On/Off.....	104
Operating	223	Auto High-Beam	108	Rear Fog Light.....	109
Head-up Display	170	Auto Idle Stop (Green).....	112	Road Departure Mitigation.....	114, 115, 116
Brightness Control	238	Auto Idle Stop System (Amber).....	112	Seat Belt Reminder	103
Heated Door Mirror Button	240	Automatic Brake Hold	99, 634	Security System Alarm.....	111
Heated Steering Wheel	285	Automatic Brake Hold System	99	Shift Down	102
Heated Windscreen Button	241	Blind spot information System	121	Shift Lever Position	102
Heaters (Front Seat)	286	Charging System	102	Shift Up	102
Heaters (Rear Seat)	287	Collision Mitigation Braking System (CMBS).....	119, 120	Supplemental Restraint System	104
HFT (Hands-Free Telephone)	441, 462	ECON Mode.....	111	System Message	108
High Beam Indicator	109	Electric Power Steering (EPS) System.....	106	Transmission System	102
Honda Sensing	29, 558	Front Fog Light.....	109	Turn Signal and Hazard Warning.....	109
		High Beam	109	Vehicle Stability Assist (VSA) System	105
		Immobilizer System	110	VSA OFF	106, 548
		Intelligent Speed Limiter	113	Instrument Panel	97
		Lane Keeping Assist System (LKAS)..	118, 606	Brightness Control	237
		Lights On	109	Intelligent Speed Limiter	540
		Low Fuel	103	Intelligent Speed Limiter Indicator	113
		Low Oil Pressure.....	101, 751	Interior Lights	268
		Low Tyre Pressure/Deflation Warning System	107, 756	Interior Rearview Mirror	245
				iPod	323, 367
I					
Identification Numbers	773				
Engine and Transmission.....	773				
Vehicle Identification	773				
Ignition Switch	217				
Illumination Control	237				
Knob	237				
Immobilizer System	204				
Indicator.....	110				

J	
Jack (Wheel Nut Wrench).....	738
Jump Starting.....	746
K	
Key Number Tag.....	180
Keyless Lockout Prevention.....	188
Keys.....	179
Lockout Prevention.....	188
Number Tag.....	180
Rear Door Won't Open.....	191
Remote Transmitter.....	185
Types and Functions.....	179
Won't turn.....	32
Kickdown (Continuously Variable Transmission).....	522
L	
Lane Keeping Assist System (LKAS).....	604
Language (HFT).....	442, 464
Lights.....	223, 694
Active Cornering Lights.....	226
Automatic.....	224
Bulb Replacement.....	694
Daytime Running Lights.....	232
Front Fog Lights.....	227
High Beam Indicator.....	109
Interior.....	268
Light Switches.....	223
Lights On Indicator.....	109
Luggage Area Lights.....	271
Rear Fog Light.....	227
Turn Signals.....	222
Load Limits.....	503
Locking/Unlocking.....	179
Childproof Door Locks.....	191
From Inside.....	189
From Outside.....	182
Keys.....	179
Using a Key.....	187
Locking/Unlocking the Doors from the Outside.....	182
Lockout Prevention System.....	188
Low Battery Charge.....	751
Low Fuel Indicator.....	103
Low Keyless Remote Signal Strength.....	181
Low Oil Pressure Indicator.....	101, 751
Low Tyre Pressure/Deflation Warning System Indicator.....	107, 756
Lower Anchorages.....	84
Lubricant Specifications Chart.....	771
Luggage (Load Limit).....	503
Luggage Area Cover.....	288
Luggage Hook.....	283
Luggage Storage Area.....	275
Lumbar Support.....	250

M

M (7-speed manual shift mode) Indicator/ Shift Indicator.....	102
Maintenance.....	657
Battery.....	712
Brake/Clutch Fluid.....	691
Cleaning.....	723
Climate Control.....	720
Coolant.....	687
Oil.....	685
Precautions.....	658
Radiator.....	688
Remote Transmitter.....	718
Replacing Light Bulbs.....	694
Safety.....	659
Service Reminder System.....	662
Transmission Fluid.....	690
Tyres.....	707
Under the Bonnet.....	680
Malfunction Indicator Lamp.....	101, 752
Manual Transmission.....	528
Map Lights.....	270
Maximum Permissible Weight.....	503
Meters, Gauges.....	147
Mirrors.....	245
Adjusting.....	245
Door.....	246
Interior Rearview.....	245
Modifications (and Accessories).....	728
MP3.....	326, 375
MP4.....	375

Multi-View Rear Camera	651	Parking Brake	629	Rear Fog Light Indicator	109
N		Parking Brake and Brake System Indicator (Amber)	100, 754	Rear Seat Heaters	287
Numbers (Identification)	773	Parking Brake and Brake System Indicator (Red)	98, 753, 754	Rear Seats	
O		Parking Sensor System	641	Second Row Seats	253
Odometer	149	Passenger Airbag Off Indicator	68	Third Row Seats	260
Off-road Guidelines	512	Passing Indicators	223	Rearview Mirror	245
Oil (Engine)	683	Petrol	28, 653	Refueling	653
Adding	686	Economy and CO ₂ Emissions	655	Fuel Gauge	147
Checking	685	Gauge	147	Low Fuel Indicator	103
Low Oil Level Indicator	757	Information	653	Petrol	653, 770
Low Oil Pressure Indicator	101, 751	Instant Fuel Economy	151	Regulations	774
Oil Monitor System	667	Low Fuel Indicator	103	Remote Transmitter	185
Recommended Engine Oil	683	Refueling	653	Replacement	
Viscosity	683	Playing Bluetooth® Audio	329, 378	Battery	715
On Board Apps	382	Power Tailgate	195	Bulbs	694
Open Source Licences	404	Power Windows	210	Fuses	758, 760
Opening/Closing		Precautions While Driving	520	Rear Wiper Blade Rubber	705
Bonnet	681	Rain	521	Tyres	734
Power Windows	210	Pregnant Women	52	Wiper Blade Rubber	702
Tailgate	192	Puncture (Tyre)	734	Resetting a Trip Meter	150
Outside Temperature Display	151	R		Reverse Tilt Door Mirror	247
Overheating	749	Radiator	688	Road Departure Mitigation	612
P		Radio (FM/AM)	314, 361	On and Off	615
Paddle Shifters	525	Radio Data System (RDS)	315, 363	S	
Panoramic Roof	213	RDS (Radio Data System)	315, 363	Safe Driving	37
		Real Time AWD with Intelligent Control System	550	Safety Check	42
				Safety Labels	95
				Safety Message	0
				Seat Belt with Detachable Anchor	51

Seat Belts	43	Won't Move	748	Sunglasses Holder.....	284
Adjusting the Shoulder Anchor	50	Selecting a Child Restraint System	76	Super Locking.....	209
Checking	53	Selector Knob (Audio).....	305	Supplemental Restraint System (SRS).....	58
Detachable Anchor	51	Service Reminder System	662	Switches (Around the Steering	
e-pretensioners	48	Setting the Clock	176	Wheel).....	4, 5, 6, 217
Fastening	49	Shift Lever	523, 528	System Message Indicator.....	108
Installing a Child Restraint System with a Lap/		Shift Lever Position Indicator.....	102, 524		
Shoulder Seat Belt.....	88	Shift Up/Down Indicators.....	102		
Pregnant Women.....	52	Shifting (Transmission).....	523, 528		
Reminder.....	45	Shoulder Anchor.....	50		
Warning Indicator	45, 103	Side Airbags	63		
Seat Heaters	286, 287	Side Curtain Airbag	65		
Seats	249	Siri Eyes Free	389		
Adjusting.....	249	Smartphone Connection	383		
Driver's Seat Lumbar Support.....	250	Song By Voice™ (SBV)	370		
Front Seat Heaters	286	SOS Button	495		
Front Seats.....	249	SOS Cancel Button	495		
Seat Heaters	286, 287	Spare Tyre	734, 771		
Second Row Seats.....	253	Spark Plugs.....	770		
Third Row Seat	260	Specifications	770		
Second Row Seats (Folding		Specified Fuel.....	653		
Down)	255, 257	Speed Limiter, Adjustable.....	536		
Security System	204	Speed Limiter, Intelligent	540		
Immobilizer System Indicator.....	110	Speedometer	147		
Security System Alarm Indicator	111	SRS Airbags (Airbags)	58		
Super Locking	209	Starting the Engine	514, 517		
Tilt Sensor.....	208	Does Not Start.....	743		
Ultrasonic Sensors.....	207	Jump Starting.....	746		
Select Lever	523	Steering Wheel	244		
Operation.....	524	Adjusting.....	244		
Releasing	748	Stopping	640		

T

Tachometer	147
Tailgate	192
Unable to Open.....	766
Temperature	
Outside Temperature Display.....	151
Temperature Sensor	151
Third Row Seat (Folding Down)	261
Third Row Seat Access	258
Tilt Sensor	208
Time (Setting)	176
Tools	732
Towing a Trailer	504
Equipment and Accessories	506
Load Limits.....	504
Trailer Stability Assist	508
Towing Your Vehicle	
Emergency	765
Traffic Sign Recognition System	618
Small Icons On and Off.....	625
Trailer Stability Assist	508

Transmission	523, 528
7-Speed Manual Shift Mode	525
Continuously Variable.....	523
Fluid	690
Manual.....	528
Number	773
Shift Lever Position Indicator	102, 524
Trip Knob	149
Trip Meter	150
Troubleshooting	731
Blown Fuse	758, 760
Brake Pedal Vibrates	33
Buzzer Sounds When Opening Door	33
Emergency Towing	765
Engine Won't Start	743
Jump Starting	746
Noise When Braking	34
Overheating.....	749
Puncture/Flat Tyre	734
Rear Door Won't Open	33, 191
Shift Lever Won't Move	748
Warning Indicators	98, 751
Turn Signals	222
Indicators (Instrument Panel).....	109
Tyres	707
Air Pressure	771
Checking and Maintaining.....	707
Inspection.....	707
Puncture (Flat Tyre).....	734
Rotation	710

Spare Tyre	734, 771
Tyre Chains	711
Wear Indicators.....	708
Winter.....	711

U

Ultrasonic Sensors	207
Unlocking the Doors	182
Unlocking the Front Doors from the Inside	17
USB Flash Drives	326, 375, 400
USB Port(s)	299

V

Vanity Mirrors	9
Vehicle Identification Numbers	773
Vehicle Speed	174
Vehicle Stability Assist (VSA)	547
Off Button.....	548
OFF Indicator.....	106
System Indicator	105
Viscosity (Oil)	683, 771
Voice Control Operation	357
Audio Commands	359
Climate Control Commands.....	360
General Commands	360
Music Search Commands	360
On Screen Commands.....	360

Phone Commands	359
Useful Commands	359
Voice Portal Screen	358
Voice Recognition	357
VSA (Vehicle Stability Assist)	547

W

Wallpaper	309, 341
Warning and Information Message	122
Warning Indicator On/Blinking	751
Warning Labels	95
Watts	770
WAV	326
Wear Indicators (Tyre)	708
Wheel Nut Wrench (Jack Handle)	738
Wi-Fi Connection	387
Window Washers	233
Adding/Refilling Fluid	692
Switch	233
Windows (Opening and Closing)	210
Windscreen	233
Cleaning	724, 726
Defrosting/Defogging	240, 293
Washer Fluid	692
Wiper Blades.....	702
Wipers and Washers	233
Winter Tyres	711
Tyre Chains.....	711

Wipers and Washers	233
Automatic Intermittent Wipers.....	234
Checking and Replacing Wiper Blades.....	702
Front.....	233
Headlight Washers.....	236
Rear.....	235
WMA	326, 375
Worn Tyres	707

