

This owner's manual should be considered a permanent part of the vehicle and should remain with the vehicle when it is sold.

This owner's manual covers all models of your vehicle. You may find descriptions of equipment and features that are not on your particular model.

Images throughout this owner's manual represent features and equipment that are available on some, but not all, models. Your particular model may not have some of these features.

The information and specifications included in this publication were in effect at the time of approval for printing. Honda Motor Co., Ltd. reserves the right, however, to discontinue or change specifications or design at any time without notice and without incurring any obligation.

Although this manual is applicable to both right-hand and left-hand drive models, the illustrations contained in this manual mainly refer to the left-hand drive models.

➤ Safe Driving P. 31

For Safe Driving P. 32 Seat Belts P. 36 Airbags P. 49

➤ Instrument Panel P. 83

Indicators P. 84 Gauges and Multi-Information Display P. 121

➤ Controls P. 137

Clock P. 138 Locking and Unlocking the Doors P. 140
Opening and Closing the Windows P. 159
Adjusting the Seats P. 183
Climate Control System* P. 208

➤ Features P. 213

Audio System P. 214 Audio System Basic Operation P. 221, 251
Customized Features P. 307 Hands-Free Telephone System P. 333, 356

➤ Driving P. 375

Before Driving P. 376 Towing a Trailer P. 380 When Driving P. 386
Multi-View Rear Camera* P. 462 Refueling P. 464

➤ Maintenance P. 469

Before Performing Maintenance P. 470 Service Reminder System* P. 473
Checking and Maintaining Wiper Blades P. 504
Heating and Cooling System*/Climate Control System* Maintenance P. 522

➤ Handling the Unexpected P. 531

Tools P. 532 If a Tyre Goes Flat P. 533
Overheating P. 558 Indicator, Coming On/Blinking P. 560

➤ Information P. 581

Specifications P. 582 Identification Numbers P. 586

Contents

Child Safety P. 62

Exhaust Gas Hazard P. 81

Safety Labels P. 82

Opening and Closing the Tailgate P. 153

Operating the Switches Around the Steering Wheel P. 161

Interior Lights/Interior Convenience Items P. 194

Security System P. 156

Adjusting the Mirrors P. 181

Heating and Cooling System* P. 204

Audio Error Messages P. 299

General Information on the Audio System P. 302

Braking P. 446

Fuel Economy P. 466

Parking Your Vehicle P. 456

Accessories and Modifications P. 467

Maintenance Schedule* P. 478

Checking and Maintaining Tyres P. 508

Cleaning P. 525

Maintenance Under the Bonnet P. 482

Battery P. 515

Replacing Light Bulbs P. 493

Remote Transmitter Care P. 520

Engine Does Not Start P. 551

Fuses P. 565

Jump Starting P. 554

Emergency Towing P. 576

Shift Lever Does Not Move P. 557

When You Cannot Open the Tailgate P. 579

Devices that Emit Radio Waves* P. 587

EC Declaration of Conformity Content Outline* P. 588

Quick Reference Guide P. 2

Safe Driving P. 31

Instrument Panel P. 83

Controls P. 137

Features P. 213

Driving P. 375

Maintenance P. 469

Handling the Unexpected P. 531

Information P. 581

Index P. 589

Visual Index

Left-hand drive type

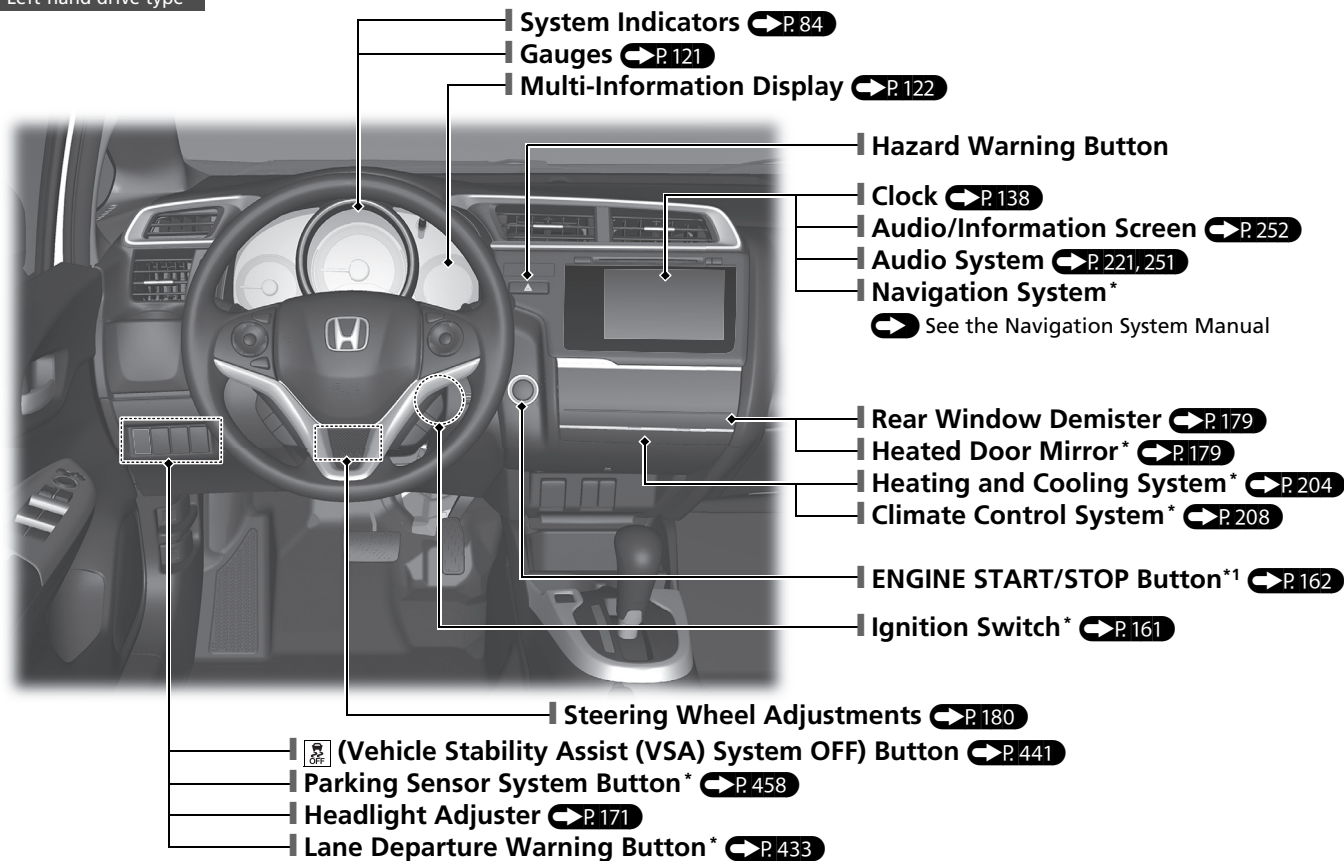

*1 : Models with the keyless access system have an **ENGINE START/STOP** button instead of an ignition switch.

Right-hand drive type

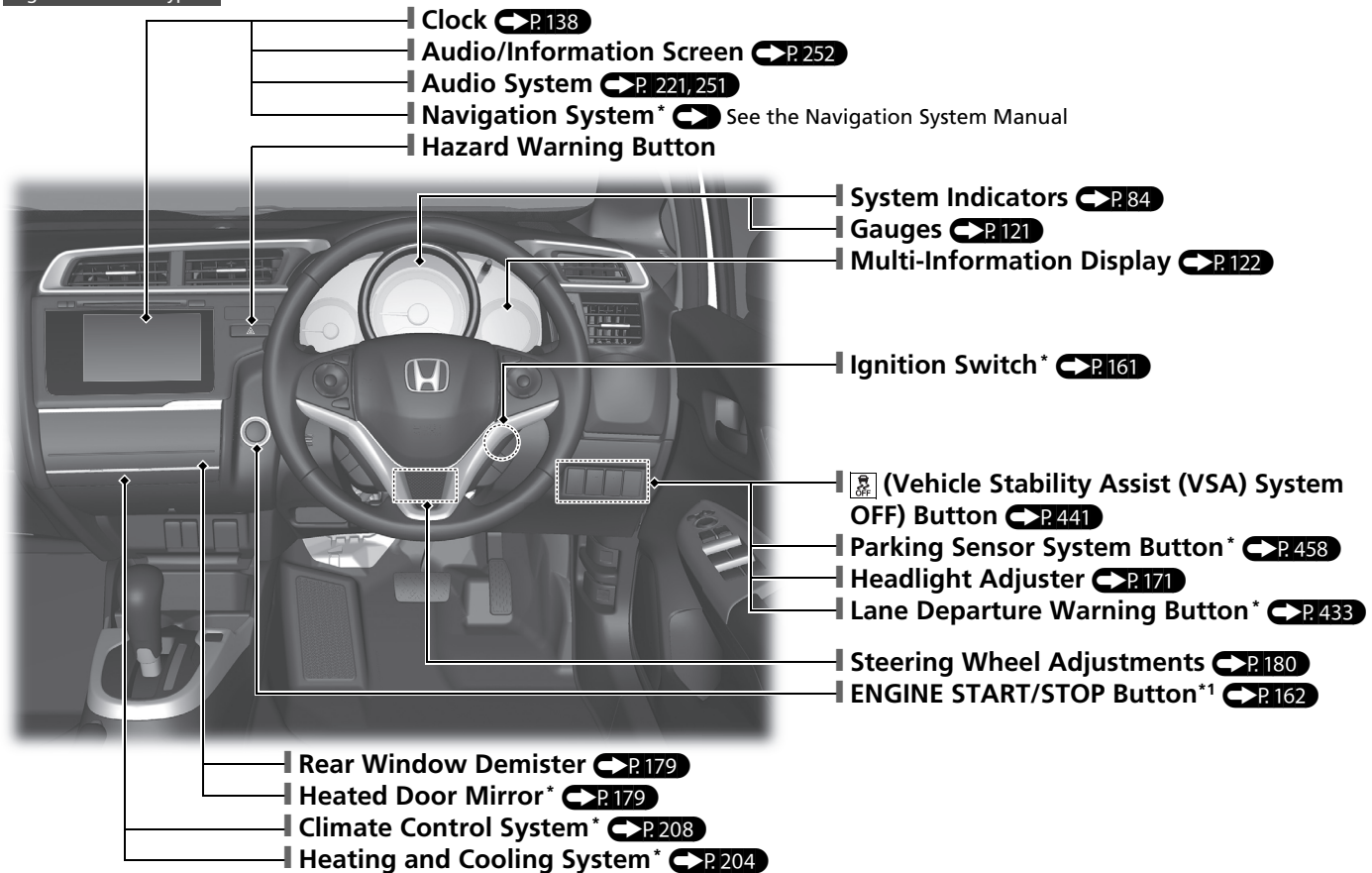

*1: Models with the keyless access system have an **ENGINE START/STOP** button instead of an ignition switch.

* Not available on all models

Visual Index

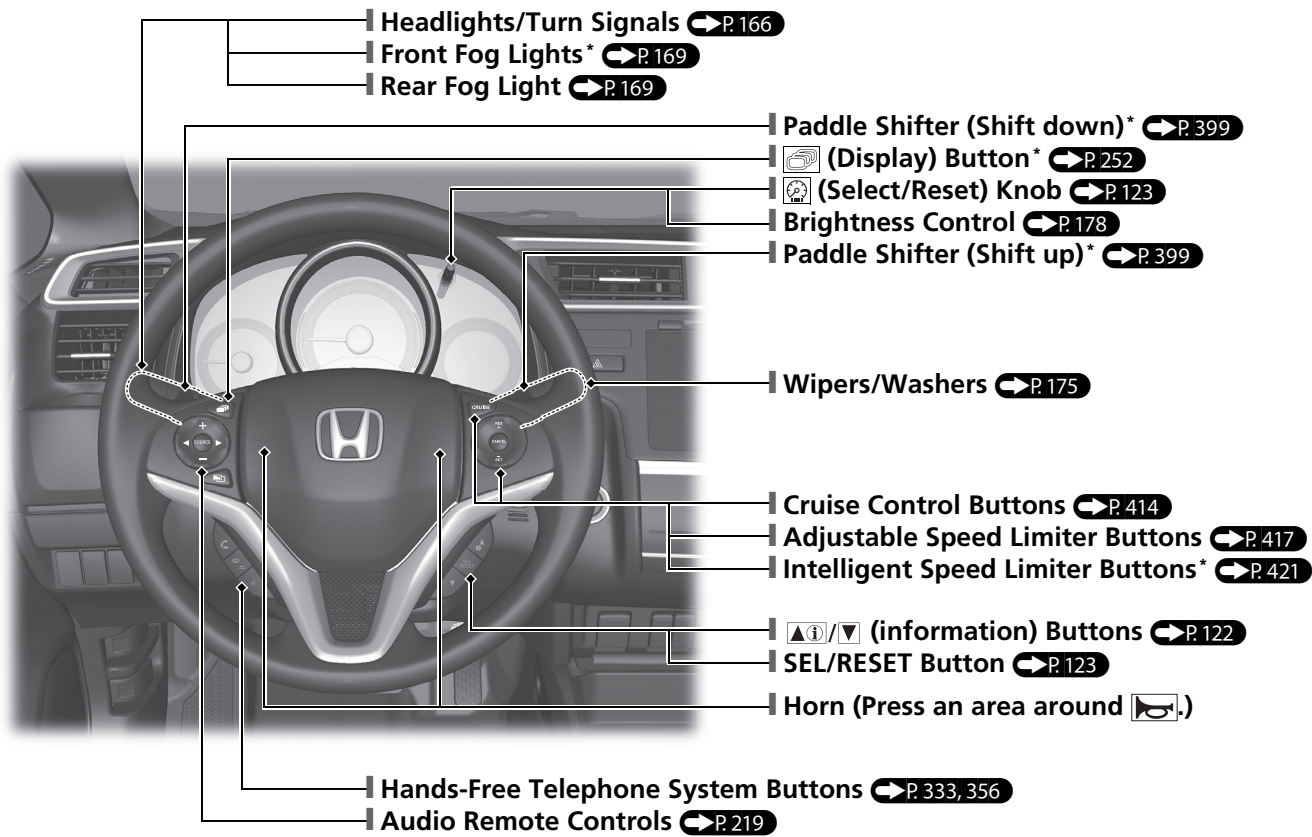

Left-hand drive type

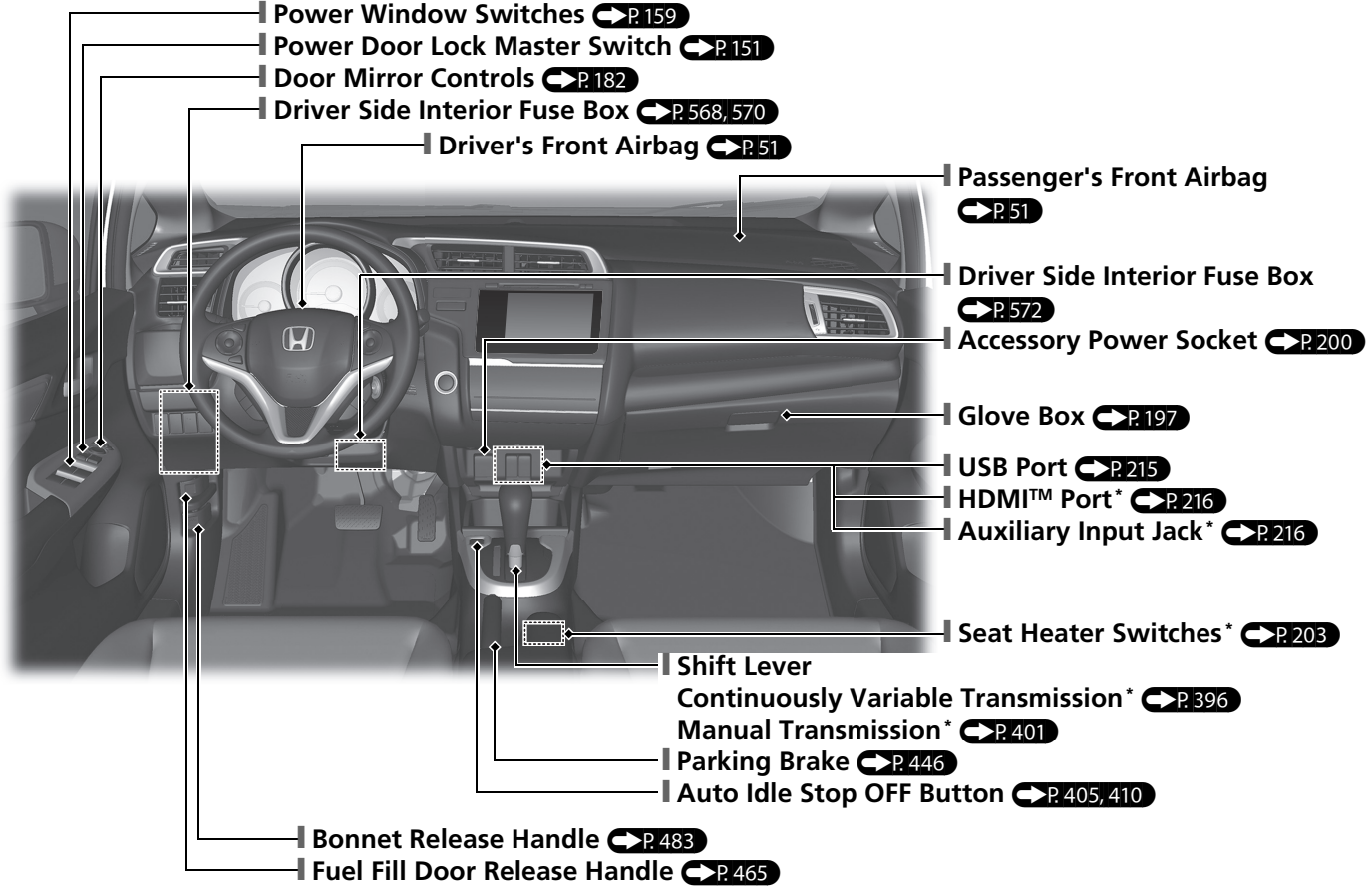

Power Window Switches ➔ P. 159

Power Door Lock Master Switch ➔ P. 151

Door Mirror Controls ➔ P. 182

Driver Side Interior Fuse Box ➔ P. 568, 570

Driver's Front Airbag ➔ P. 51

Passenger's Front Airbag

➔ P. 51

Driver Side Interior Fuse Box

➔ P. 572

Accessory Power Socket ➔ P. 200

Glove Box ➔ P. 197

USB Port ➔ P. 215

HDMI™ Port* ➔ P. 216

Auxiliary Input Jack* ➔ P. 216

Seat Heater Switches* ➔ P. 203

Shift Lever

Continuously Variable Transmission* ➔ P. 396

Manual Transmission* ➔ P. 401

Parking Brake ➔ P. 446

Auto Idle Stop OFF Button ➔ P. 405, 410

Bonnet Release Handle ➔ P. 483

Fuel Fill Door Release Handle ➔ P. 465

* Not available on all models

Visual Index

Right-hand drive type

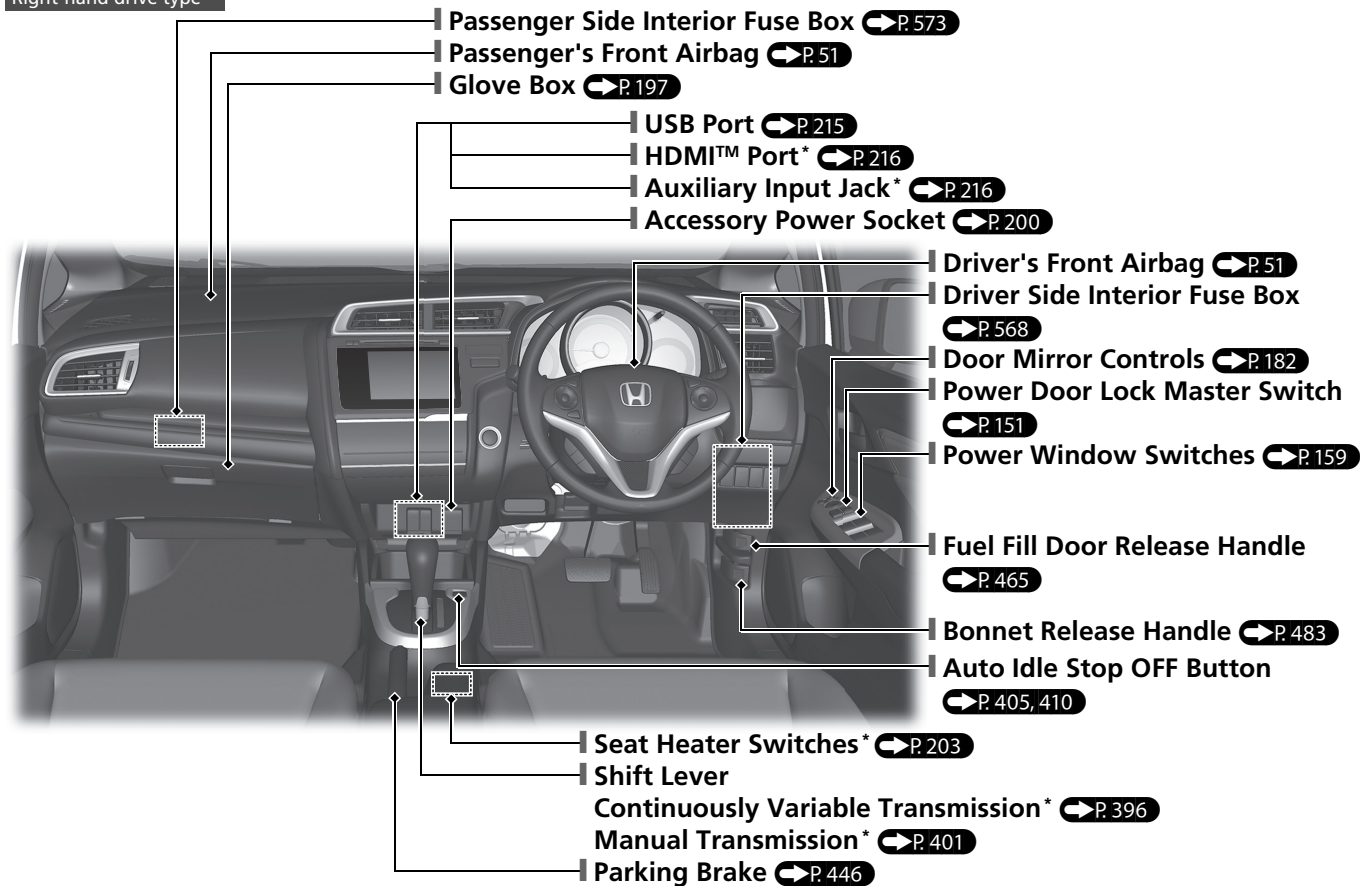

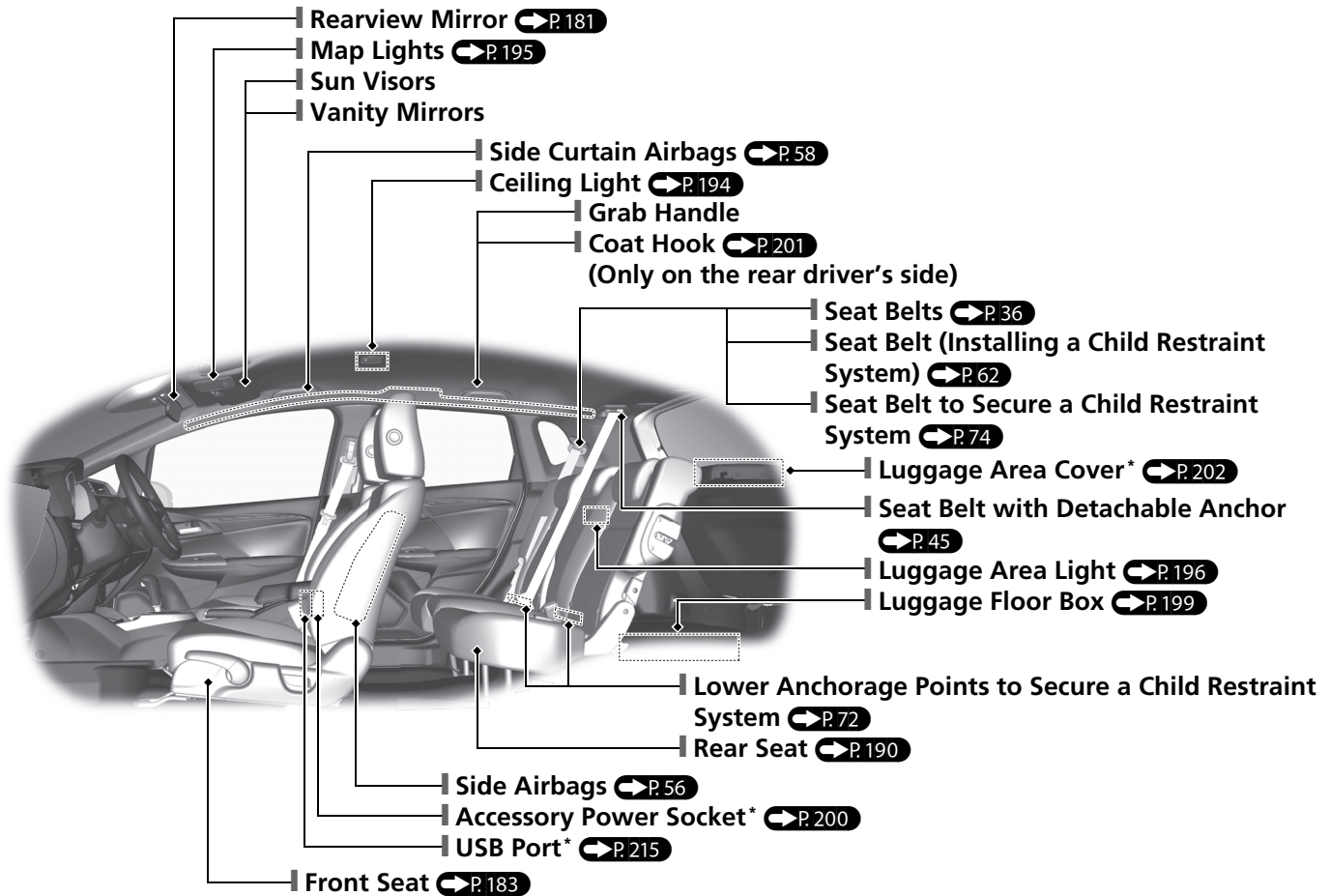



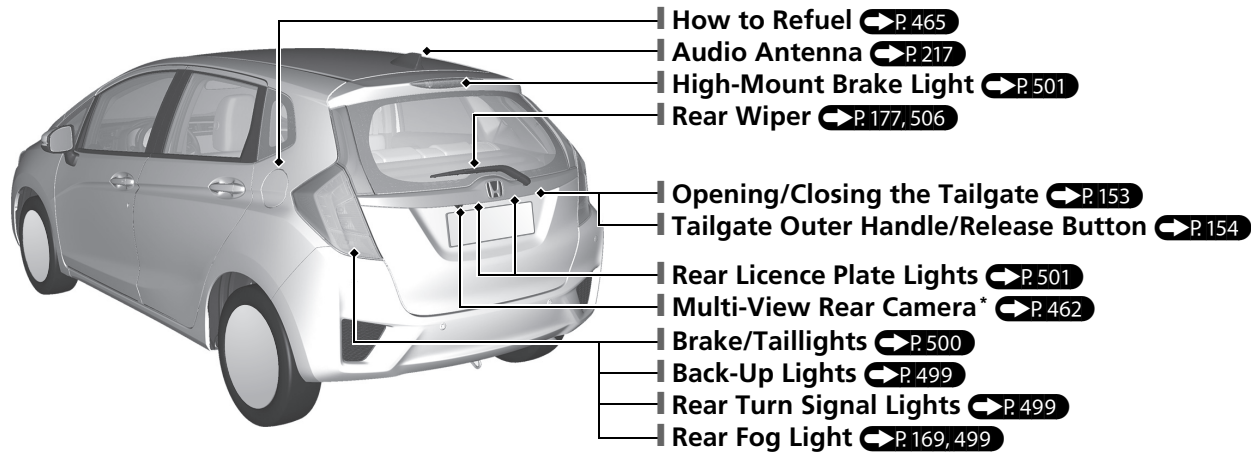
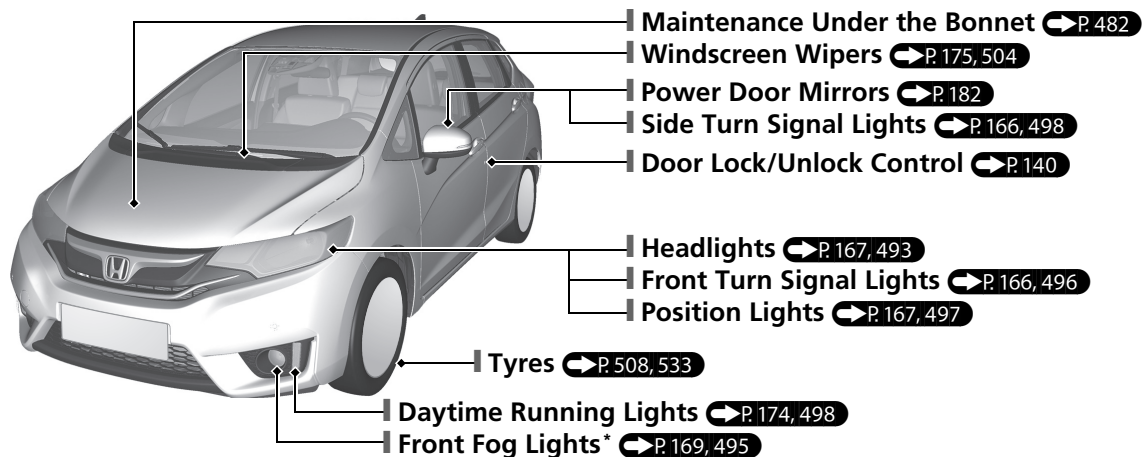



Visual Index

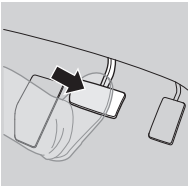
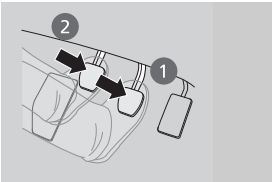

Auto Idle Stop Function

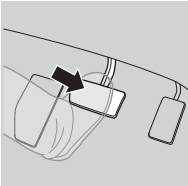
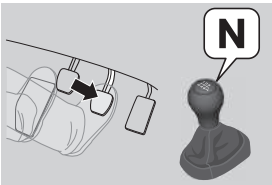
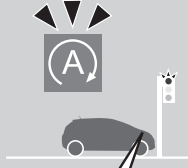
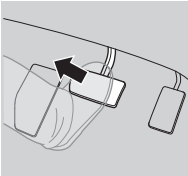
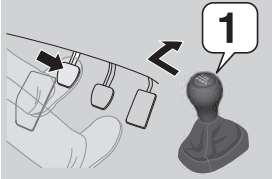
To improve fuel economy, the engine stops and then restarts as detailed below. When Auto Idle Stop is on, the Auto Idle Stop indicator (green) comes on.  P.404, 409

At	Continuously variable transmission	Manual transmission	Engine status
<p>Deceleration</p> 	<p>Depress the brake pedal.</p> 	<ol style="list-style-type: none"> 1. Depress the brake pedal. 2. Fully depress the clutch pedal. 	 <p>On</p>
<p>Stop</p> 	<p>Keep the brake pedal depressed.</p> 	<ul style="list-style-type: none"> ● Continue to depress the brake pedal. ● Move the shift lever to N. ● Release the clutch pedal. 	 <p>Off</p>
<p>Start-up</p>	<p>Release the brake pedal.</p> 	<ol style="list-style-type: none"> 1. Depress the clutch pedal again. 2. Move the shift lever to 1. 3. Depress the accelerator pedal to resume driving. 	 <p>Restarting</p>

Safe Driving [↔ P.31](#)

Airbags [↔ P.49](#)

- Your vehicle is fitted with airbags to help protect you and your passengers during a moderate-to-severe collision.

Child Safety [↔ P.62](#)

- All children 12 and younger should be seated in the rear seat.
- Small children should be properly restrained in a front facing restraint system.
- Infants must be properly restrained in a rearward facing restraint system on a rear seat.

Exhaust Gas Hazard [↔ P.81](#)

- Your vehicle emits dangerous exhaust gases that contain carbon monoxide. Do not run the engine in confined spaces where carbon monoxide gas can accumulate.

Seat Belts [↔ P.36](#)

- Fasten your seat belt and sit with a correct posture.
- Check that your passengers are wearing their seat belts correctly.

Before Driving Checklist [↔ P.35](#)

- Before driving, check that the front seats, head restraints, steering wheel, and mirrors have been properly adjusted.

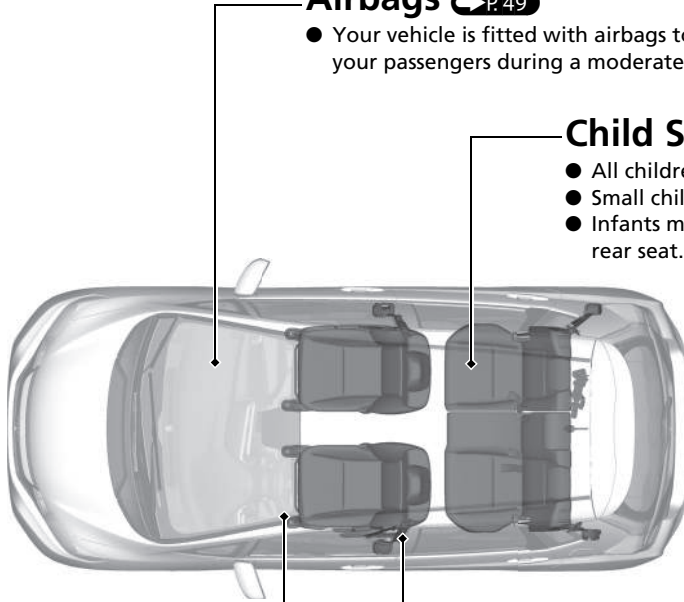













Fasten your lap belt as low as possible.

Instrument Panel P.83



Gauges P.121 / Multi-Information Display P.122 / System Indicators P.84

System Indicators

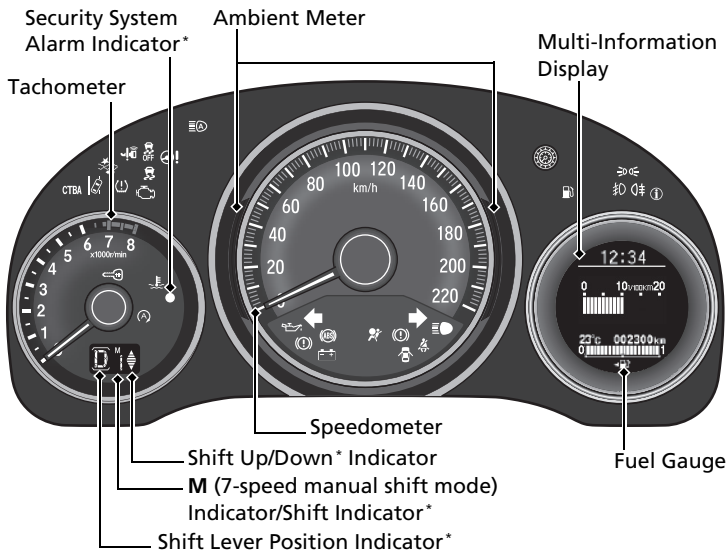
-  Malfunction Indicator Lamp
-  Low Oil Pressure Indicator
-  Charging System Indicator
-  Vehicle Stability Assist (VSA) System Indicator
-  VSA OFF Indicator
-  Immobilizer System Indicator
-  Keyless Access System Indicator*
-  Electric Power Steering (EPS) System Indicator
-  High Temperature Indicator (Red)
-  Low Temperature Indicator (Blue)
-  Auto Idle Stop Indicator (Green)
-  Auto Idle Stop System Indicator (Amber)













System Indicators

-  Forward Collision Warning Indicator*
-  Lane Departure Warning Indicator*
-  Low Tyre Pressure/Deflation Warning System Indicator

Lights Indicators

-  Lights On Indicator
-  High Beam Indicator
-  Front Fog Light Indicator*
-  Rear Fog Light Indicator

System Indicators

-  Turn Signal and Hazard Warning Indicators
-  Anti-lock Brake System (ABS) Indicator
-  Parking Brake and Brake System Indicator (Red)
-  Brake System Indicator (Amber)
-  Door and Tailgate Open Indicator
-  Low Fuel Indicator
-  Seat Belt Reminder Indicator
-  Supplemental Restraint System Indicator
-  High Beam Support System Indicator*
-  City-Brake Active System (CTBA) Indicator
-  System Message Indicator

* Not available on all models

Controls P.137

Clock P.138

Models with navigation system





The navigation system receives signals from GPS satellites, updating the clock automatically.

Models with audio system

The clock in the multi-information display is automatically updated along with the audio system's clock display.

Models with colour audio system





- 1 Press and hold the **MENU/CLOCK** button.
- 2 Rotate  to change hour, then press .
- 3 Rotate  to change minute, then press .
- 4 Select **SET**, then press .

These indications are used to show how to operate the **LIST/SELECT** (Selector) knob.

- Rotate  to select.
- Press  to enter.

Models with display audio system



- 1 Select the  (HOME) icon, then select **Settings**.
- 2 Select **Info**, **Clock**, then **Clock Adjustment**.
- 3 Touch the  /  icon to adjust the numbers up or down.
- 4 Select **OK**.

ENGINE START/STOP

Button* P.162

Press the button to change the vehicle's power mode.

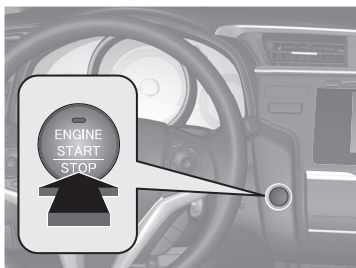

Turn Signals P.166

Turn Signal Control Lever

Right

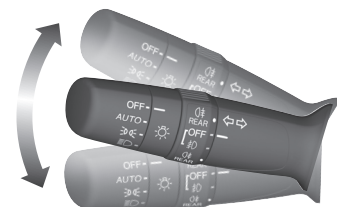

Left

Lights P.167

Light Control Switches

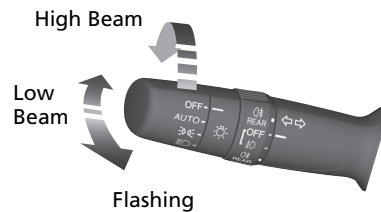

Wipers and Washers

➔ P.175

Wiper/Washer Control Lever

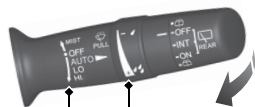

Pull toward you to spray washer fluid.

Adjustment Ring

☹ : Low Sensitivity

☺ : High Sensitivity

MIST
OFF

AUTO: Wiper speed varies automatically

LO: Low speed wipe

HI: High speed wipe

Steering Wheel ➔ P.180

- To adjust, pull the adjustment lever towards you, adjust to the desired position, then lock the lever back in place.

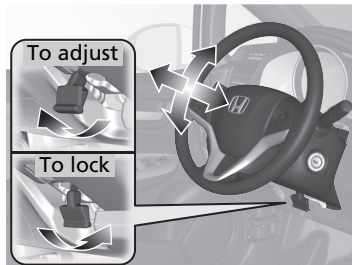

Unlocking the Front Doors from the Inside ➔ P.150

➔ P.150

- Pull either front door inner handle to unlock and open it in one motion.

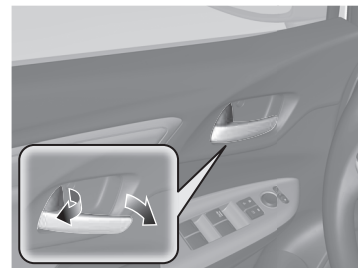

- Unlocking and opening the driver's door from the inner handle unlocks all the other doors.

Tailgate P.153

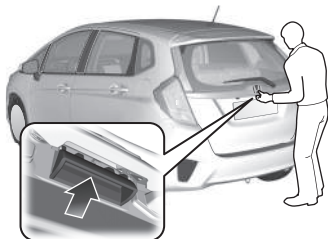

Models without keyless access system

- With all the doors unlocked, pull the tailgate outer handle, and lift up to open it.

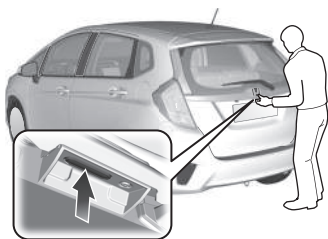

Models with keyless access system

- With all the doors unlocked, push the tailgate release button on the tailgate to open it.
- Press the tailgate release button to unlock and open the tailgate when you carry the keyless access remote.

Power Door Mirrors

P.182

- With the ignition switch in ON ^{*1}, move the selector switch to L or R.
- Push the appropriate edge of the adjustment switch to adjust the mirror.
- Press the folding button* to fold in and out the door mirrors.

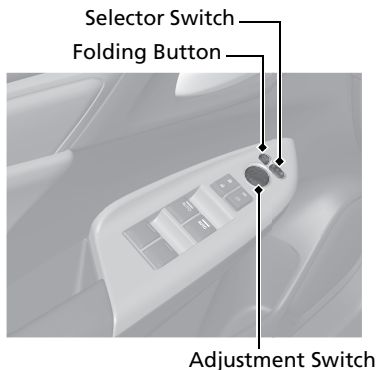





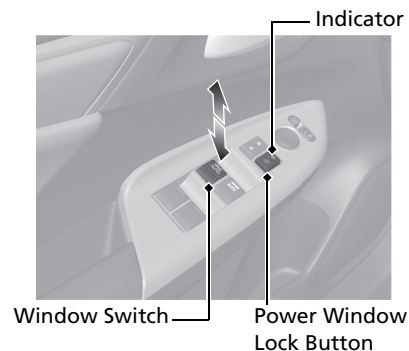

Power Windows P.159

- With the ignition switch in ON ^{*1}, open and close the power windows.
- If the power window lock button is in the off position, each passenger's window can be opened and closed with its own switch.
- If the power window lock button is in the on position (indicator on), each passenger's window switch is disabled.





*1: Models with the keyless access system have an **ENGINE START/STOP** button instead of an ignition switch.

Heating and Cooling System*

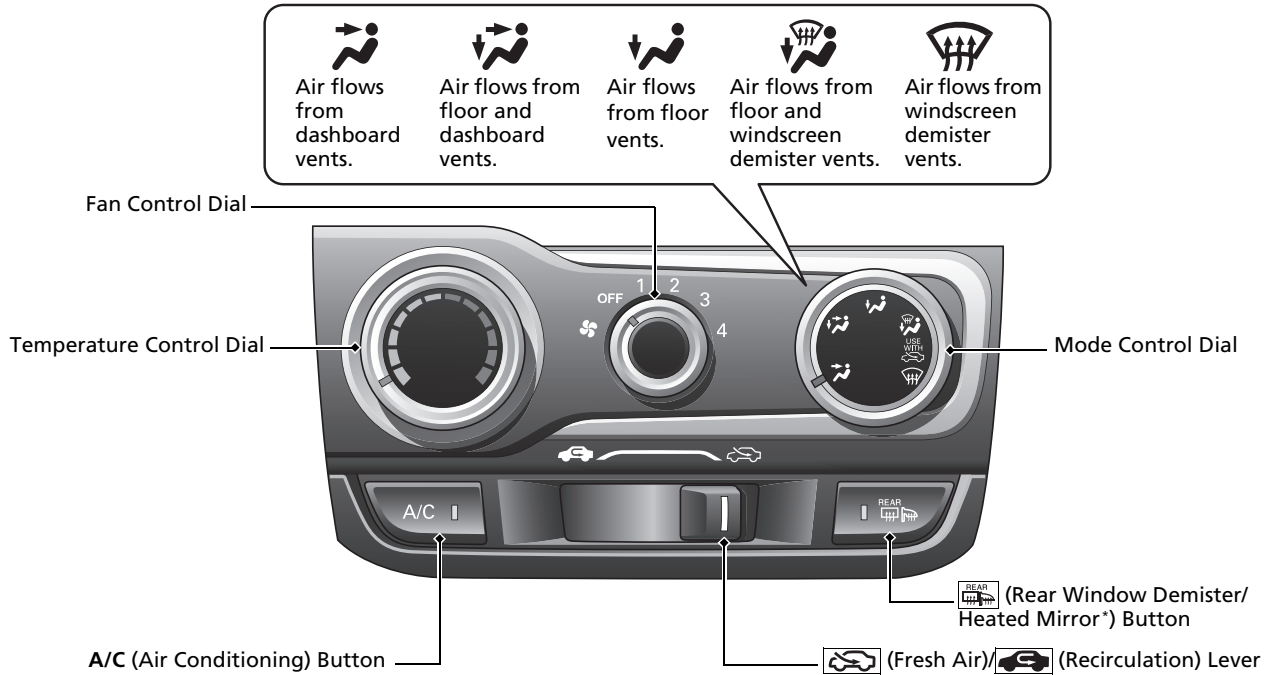
- Rotate the fan control dial to adjust the fan speed.
- Rotate the mode control dial ( /  /  /  / ) to select the vents air flows from.
- Rotate the temperature control dial to adjust the temperature.
- Rotate the fan control dial to **OFF** to turn the system off.
- Rotate the mode control dial to  to defrost the windscreen.



Climate Control System* P. 208

- Select the **AUTO** icon to activate the climate control system.
- Select the  icon to turn the system on or off.
- Select the  icon to defrost the windscreen.

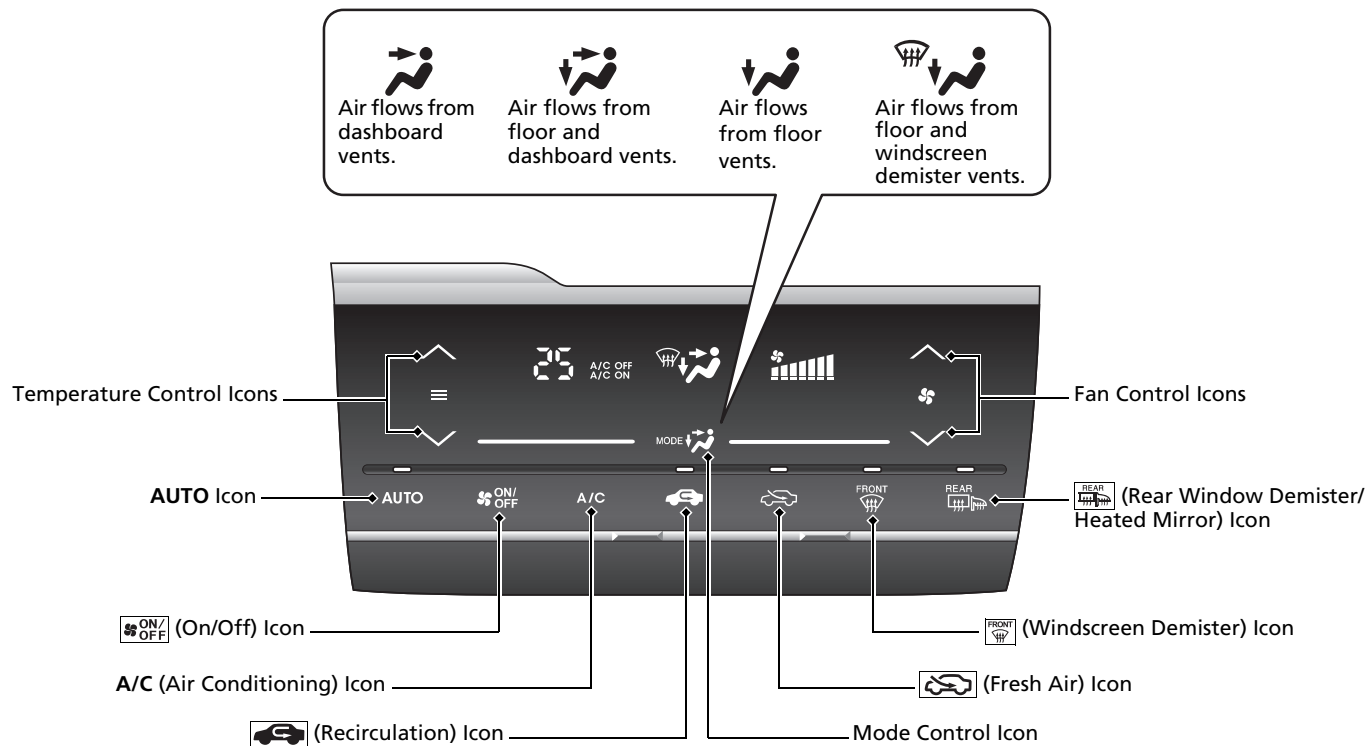

* Not available on all models

Features P.213

Audio System P.221, 251

Models with colour audio system  P. 221

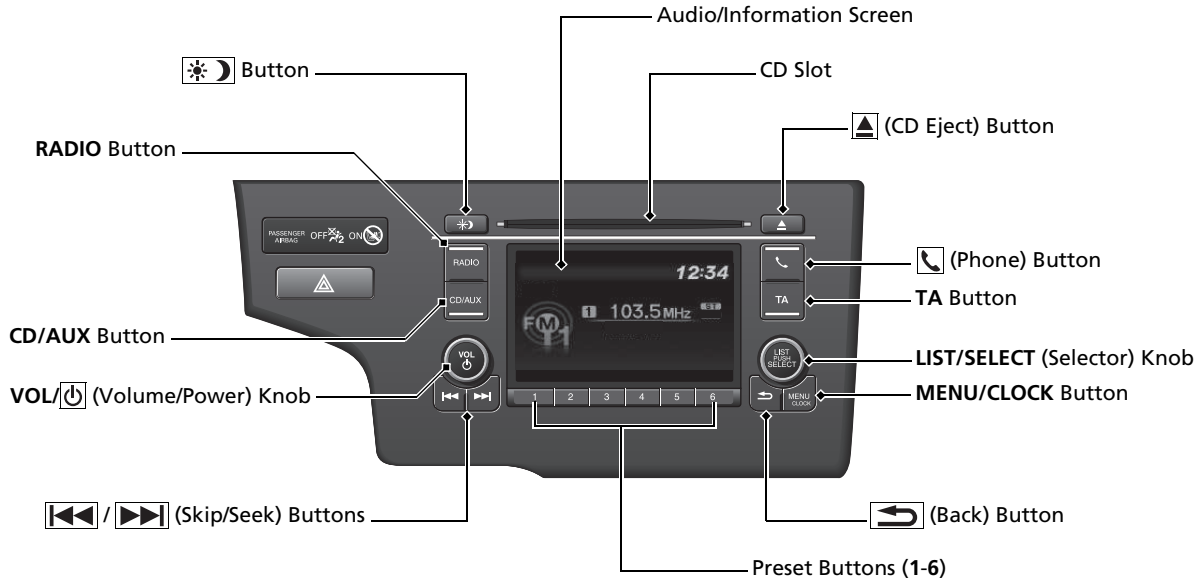

Models without navigation system

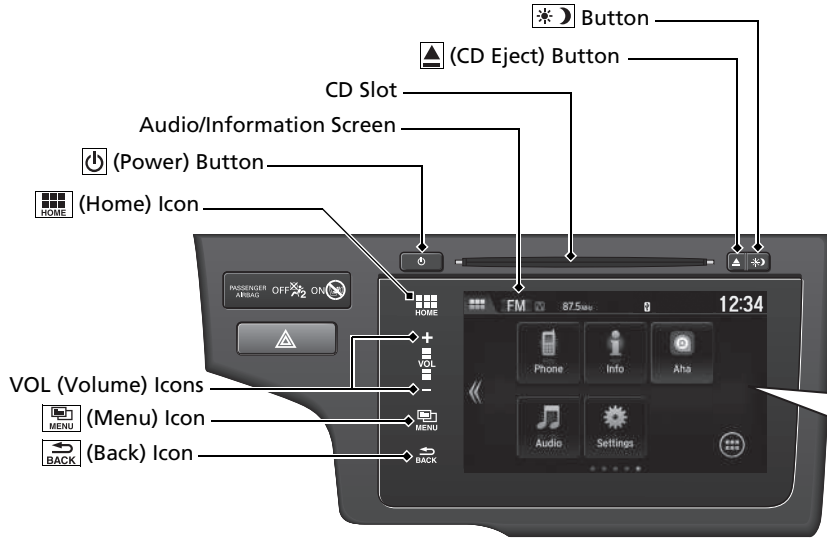

Models with navigation system



Audio Remote Controls

➔ P.219

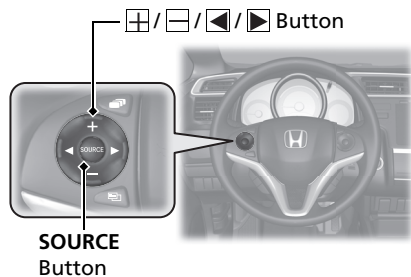

- **+** / **-** Button
Press to adjust the volume up/down.
- **SOURCE** Button
Press to change the audio mode:
 - Models with colour audio system**
FM1/FM2/DAB1*/DAB2*/LW/MW/CD/USB/
iPod/*Bluetooth*®Audio/AUX.
 - Models with display audio system**
FM/LW/MW/DAB*/CD/USB/iPod/Apps/
Bluetooth®Audio/AUX HDMI™.
- **◀** / **▶** Button
Radio: Press to change the preset station.
Press and hold to select the next or previous strong station.
CD/USB device:
Press to skip to the beginning of the next song or return to the beginning of the current song.
Press and hold to change a folder.

Driving ➔ P.375

Manual Transmission* ➔ P.401

Continuously Variable Transmission* ➔ P.396

- Shift to **P** and depress the brake pedal when starting the engine.

Shifting

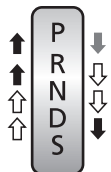

- ↓ Depress the brake pedal and press the release button to move out of **P**.
- ↓↑ Move the shift lever without pressing the release button.
- ↓↑ Press the release button to move the shift lever.

- P** **Park**
Turn off or start the engine.
Transmission is locked.
- R** **Reverse**
Used when reversing.
- N** **Neutral**
Transmission is not locked.
- D** **Drive**
 - Normal driving.
 - 7-speed manual shift mode can be used.
- S** **S Position**
 - Better acceleration.
 - Increased engine braking.
 - Going up or down hills.
 - 7-speed manual shift mode can be used.
 - When towing a trailer in hilly terrain.



7-Speed Manual Shift Mode* ➔ P.398

- Allows you to manually shift the transmission up or down without removing your hands from the steering wheel.

When the shift lever is in **S**

- Pulling a paddle shifter changes the mode from continuously variable transmission to 7-speed manual shift mode.
- The **M** indicator and the selected speed number are displayed in the shift indicator.

When the shift lever is in **D**

- Pulling a paddle shifter temporarily changes the mode from continuously variable transmission to 7-speed manual shift mode. The selected speed number is displayed in the shift indicator.

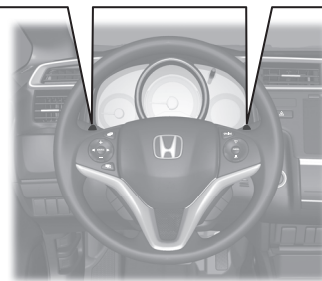
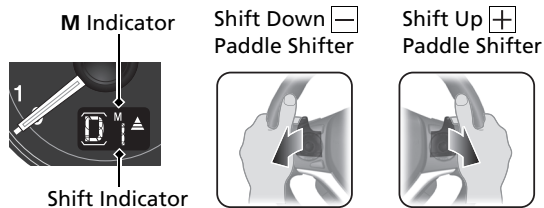

* Not available on all models

VSA OFF Button P.441

- The vehicle stability assist (VSA) system helps to stabilize the vehicle during cornering, and helps to maintain traction while accelerating on loose or slippery road surfaces.
- VSA comes on automatically every time you start the engine.
- To turn VSA on or off, press and hold the button until you hear a beep.

Cruise Control P.414

- Cruise control allows you to maintain a set speed without keeping your foot on the accelerator pedal.
- To use cruise control, press the **MAIN** button. Select cruise control by pressing the **LIM** button, then press the **-/SET** button once you have achieved the desired speed (above 30 km/h or 18 mph).

Adjustable Speed Limiter

 P.417

- This system enables you to set a maximum speed that cannot be exceeded even if you are depressing the accelerator pedal.
- To use the adjustable speed limiter, press the **MAIN** button. Select the adjustable speed limiter by pressing the **LIM** button, then press the **-/SET** when your vehicle reaches the desired speed.
- The vehicle speed limit can be set from 30 km/h (18 mph) to 250 km/h (156 mph).

Deflation Warning System (DWS) P.443

DWS detects a change in tyre revolutions as a decrease in tyre pressure.

Refueling P.464

Fuel recommendation: Premium unleaded petrol with a research octane number 95 or higher required
Fuel tank capacity: 40 L (8.8 Imp gal)

- 1** Pull the fuel fill door release handle.

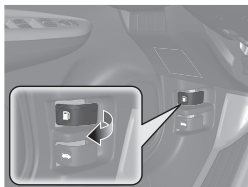

- 2** Turn the fuel fill cap slowly to remove the cap.

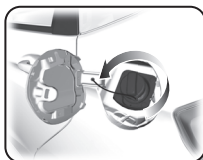

- 3** Place the cap in the holder on the fuel fill door.



- 4** After refueling, screw the cap back on until it clicks at least once.



Maintenance P.469

Under the Bonnet P.482

- Check engine oil, engine coolant, and windscreen washer fluid. Add when necessary.
- Check brake fluid.
- Check the battery condition monthly.

- 1 Pull the bonnet release handle under the corner of the dashboard.

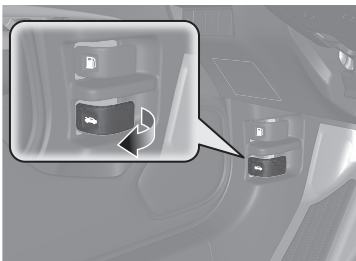

- 2 Locate the bonnet latch lever, pull the lever up, and lift up the bonnet.

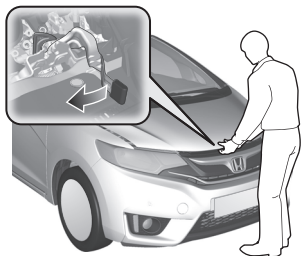

- 3 When finished, close the bonnet and make sure it is firmly locked in place.

Wiper Blades P.504

- Replace blades if they leave streaks across the windscreen.



Tyres P.508

- Inspect tyres and wheels regularly.
- Check tyre pressures regularly.
- Install winter tyres for winter driving.

Lights P.493

- Inspect all lights regularly.

Handling the Unexpected P.531

Flat Tyre P.533

Models with a spare tyre

- Park in a safe location and replace the flat tyre with the compact spare tyre in the luggage area.

Models with tyre repair kit

- Park in a safe location and repair the flat tyre using the tyre repair kit.



Engine Won't Start P.551

- If the battery is dead, jump start using a booster battery.

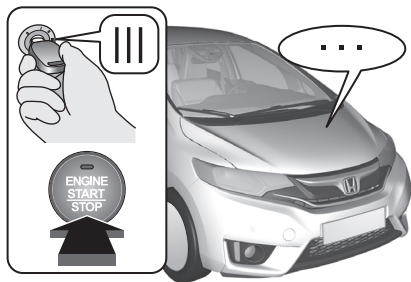

Overheating P.558

- Park in a safe location. If you do not see steam under the bonnet, open the bonnet, and let the engine cool down.



Indicators Come On P.560

- Identify the indicator and consult the owner's manual.

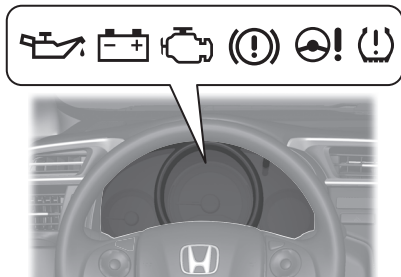

Blown Fuse P.565

- Check for a blown fuse if an electrical device does not operate.

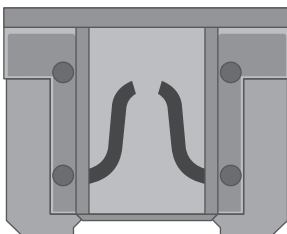

Emergency Towing P.576

- Call a professional towing service if you need to tow your vehicle.



What to Do If

Q The ignition switch does not turn from **0** to **I***1. Why?

- A**
- The steering wheel may be locked.
- Models without keyless access system**
- Try to turn the steering wheel left and right while turning the ignition key.
- Models with keyless access system**
- Move the steering wheel left and right while pressing the **ENGINE START/STOP** button at the same time.

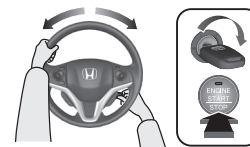

Q **Models without keyless access system**
The ignition switch does not turn from **I** to **0** and I cannot remove the key. Why?

A The shift lever should be moved to **P**.

Models with keyless access system
The power mode does not change from ON to VEHICLE OFF (LOCK). Why?



Q Why does the brake pedal pulsate slightly when applying the brakes?

A This can occur when the ABS activates, and does not indicate a problem. Apply firm, steady pressure on the brake pedal. Never pump the brake pedal.

*1: Models with the keyless access system have an **ENGINE START/STOP** button instead of an ignition switch.

Q The rear door cannot be opened from inside the vehicle. Why?

A Check if the childproof lock is in the lock position. If so, open the rear door with the outside door handle. To cancel this function, push the lever to the unlock position.

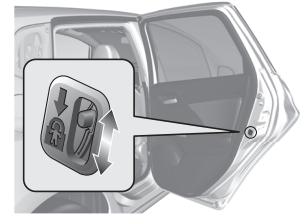

Q Why do the doors lock after I unlocked the doors using a remote transmitter?

A If you do not open a door within 30 seconds, the doors are relocked automatically for security.

Q Why does the beeper sound when I open the driver's door?

A The beeper sounds when:

- The exterior lights are left on.
- Auto Idle Stop is in operation.

Models without keyless access system

- The key is left in the ignition switch.

Models with keyless access system

- The power mode is in ACCESSORY.

Q Why does the beeper sound when I start driving?

A The beeper sounds when:

- Driver and/or front passenger are not wearing their seat belts.
- The parking brake lever is not fully released.



Why do I hear a screeching sound when I apply the brake pedal?



The brake pads may need to be replaced. Have your vehicle inspected by a dealer.



Is it possible to use unleaded petrol with a Research Octane Number (RON) of 91 or higher on this vehicle?



Unleaded petrol with a research octane number of 95 or higher is recommended. Your vehicle is designed to operate on premium unleaded petrol with a research octane of 95 or higher. If this octane grade is unavailable, regular unleaded petrol with a research octane of 91 or higher may be used temporarily. The use of regular unleaded petrol can cause metallic knocking noises in the engine and will result in decreased engine performance. The long-term use of regular-grade petrol can lead to engine damage.

Event Data Recorders

Your vehicle is equipped with several devices commonly referred to as Event Data Recorders. They record various types of real time vehicle data such as SRS airbag deployment and SRS system components failure.

This data belongs to the vehicle owner and may not be accessed by anyone else except as legally required or with the permission of the vehicle owner.



However this data may be accessed by Honda, its authorised dealers and authorised repairers, employees, representatives and contractors only for the purpose of the technical diagnosis, research and development of the vehicle.

Service Diagnostic Recorders

Your vehicle is equipped with service-related devices that record information about powertrain performance and driving conditions. The data can be used to help technicians diagnose, repair and maintain the vehicle. This data may not be accessed by anyone else except as legally required or with the permission of the vehicle owner.

However this data may be accessed by Honda, its authorised dealers and authorised repairers, employees, representatives and contractors only for the purpose of the technical diagnosis, research and development of the vehicle.

As you read this manual, you will find Information that is preceded by a **NOTICE** symbol. This information is intended to help you avoid damage to your vehicle, other property, or the environment.

Symbols   on labels attached to your vehicle are to remind you to read this owner's manual for proper and safe operation of your vehicle.

 is colour-coded to indicate "danger" (red), "warning" (orange), or "caution" (amber).

A Few Words About Safety

Your safety, and the safety of others, is very important. And operating this vehicle safely is an important responsibility.

To help you make informed decisions about safety, we have provided operating procedures and other information on labels and in this manual. This information alerts you to potential hazards that could hurt you or others.

Of course, it is not practical or possible to warn you about all the hazards associated with operating or maintaining your vehicle. You must use your own good judgement.

You will find this important safety information in a variety of forms, including:

- **Safety Labels** - on the vehicle.
- **Safety Messages** - preceded by a safety alert symbol  and one of three signal words: **DANGER**, **WARNING**, or **CAUTION**. These signal words mean:

 **DANGER**

You **WILL** be **KILLED** or **SERIOUSLY HURT** if you don't follow instructions.

 **WARNING**

You **CAN** be **KILLED** or **SERIOUSLY HURT** if you don't follow instructions.

 **CAUTION**

You **CAN** be **HURT** if you don't follow instructions.

- **Safety Headings** - such as Important Safety Precautions.
- **Safety Section** - such as Safe Driving.
- **Instructions** - how to use this vehicle correctly and safely.

This entire book is filled with important safety information - please read it carefully.

Safe Driving

You can find many safety recommendations throughout this chapter, and throughout this manual.

For Safe Driving

Important Safety Precautions	32
Your Vehicle's Safety Features.....	34

Seat Belts

About Your Seat Belts.....	36
Fastening a Seat Belt.....	42
Seat Belt Inspection.....	47

Airbags

Airbag System Components.....	49
Types of Airbags	51
Front Airbags (SRS)	51
Side Airbags.....	56

Side Curtain Airbags	58
Airbag System Indicators.....	59
Airbag Care	61

Child Safety

Protecting Child Passengers	62
Safety of Infants and Small Children ..	66
Safety of Larger Children	78

Exhaust Gas Hazard

Carbon Monoxide Gas.....	81
--------------------------	----

Safety Labels

Label Locations	82
-----------------------	----

The following pages explain your vehicle's safety features and how to use them properly. The safety precautions below are ones that we consider to be among the most important.

Important Safety Precautions

■ Always wear your seat belt

A seat belt is your best protection in all types of collisions. Airbags are designed to supplement seat belts, not replace them. So even though your vehicle is equipped with airbags, make sure you and your passengers always wear your seat belts, and wear them properly.

■ Restrain all children

Children aged 12 and under should ride properly restrained in a back seat, not the front seat. Infants and small children should be restrained in a child restraint system. Larger children should use a booster seat and a lap/shoulder seat belt until they can use the belt properly without a booster seat.

■ Be aware of airbag hazards

While airbags can save lives, they can cause serious or fatal injuries to occupants who sit too close to them, or are not properly restrained. Infants, young children, and short adults are at the greatest risk. Be sure to follow all instructions and warnings in this manual.

■ Don't drink and drive

Alcohol and driving don't mix. Even one drink can reduce your ability to respond to changing conditions, and your reaction time gets worse with every additional drink. So don't drink and drive, and don't let your friends drink and drive, either.

⌘ Important Safety Precautions

Some countries prohibit the use of mobile phones other than hands-free devices by the driver while driving.

■ Pay appropriate attention to the task of driving safely

Engaging in mobile phone conversation or other activities that keep you from paying close attention to the road, other vehicles, and pedestrians could lead to a crash. Remember, situations can change quickly, and only you can decide when it is safe to divert some attention away from driving.

■ Control your speed

Excessive speed is a major factor in crash injuries and deaths. Generally, the higher the speed, the greater the risk, but serious injuries can also occur at lower speeds. Never drive faster than is safe for current conditions, regardless of the maximum speed posted.

■ Keep your vehicle in safe condition

Having a tyre blowout or a mechanical failure can be extremely hazardous. To reduce the possibility of such problems, check your tyre pressures and condition frequently, and perform all regularly scheduled maintenance.

Your Vehicle's Safety Features

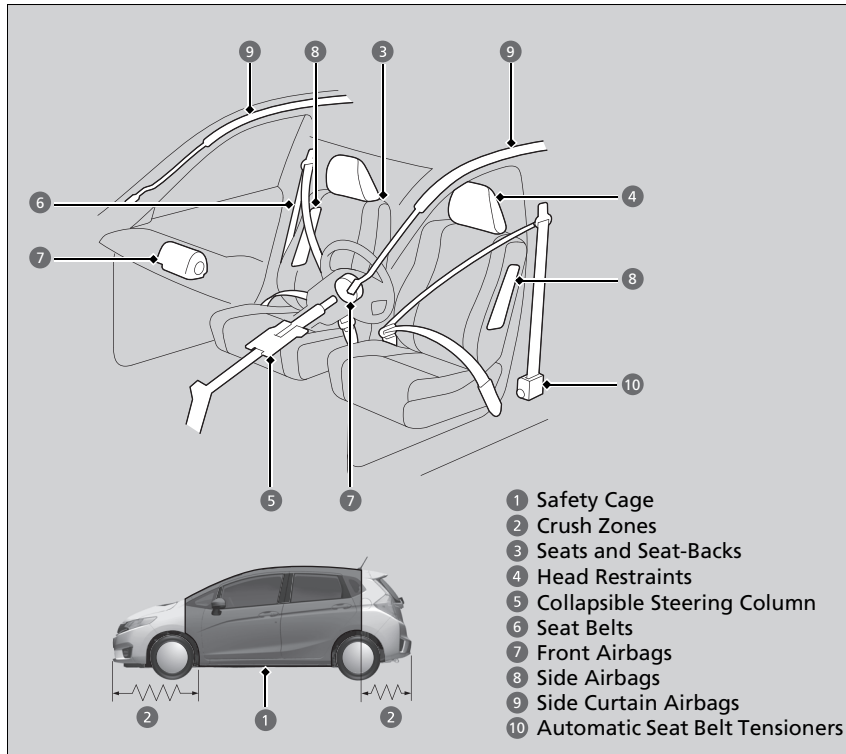

The following checklist will help you take an active role in protecting yourself and your passengers.

► Your Vehicle's Safety Features

Your vehicle is equipped with many features that work together to help protect you and your passengers during a crash.

Some features do not require any action on your part. These include a strong steel framework that forms a safety cage around the passenger compartment, front and rear crush zones, a collapsible steering column, and tensioners that tighten the front and rear outer seat belts in a sufficient crash.

However, you and your passengers cannot take full advantage of these features unless you remain seated in the correct position and always wear your seat belts. In fact, some safety features can contribute to injuries if they are not used properly.

Safety Checklist

For the safety of you and your passengers, make a habit of checking these items each time before you drive.

- Adjust your seat to a position suitable for driving. Be sure the front seats are adjusted as far to the rear as possible while allowing the driver to control the vehicle. Sitting too close to a front airbag can result in serious or fatal injury in a crash.
 - **Adjusting the Seats** P. 183
- Adjust head restraints to the proper position. Head restraints are most effective when the centre of the head restraint aligns with the centre of your head. Taller persons should adjust their head restraint to the highest position.
 - **Adjusting the Head Restraints** P. 185
- Always wear your seat belt, and make sure you wear it properly. Confirm that any passengers are properly belted as well.
 - **Fastening a Seat Belt** P. 42
- Protect children by using seat belts or child restraint system according to a child's age, height and weight.
 - **Child Safety** P. 62

» Safety Checklist

If the door and tailgate open indicator is on, a door and/or the tailgate is not completely closed. Close all doors and the tailgate tightly until the indicator goes off.

➤ **Door and Tailgate Open Indicator** P. 93

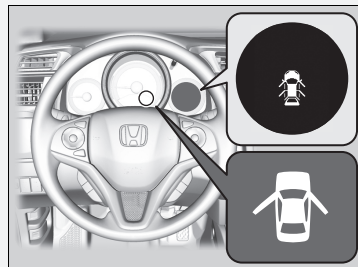

About Your Seat Belts

Seat belts are the single most effective safety device because they keep you connected to the vehicle so that you can take advantage of many built-in safety features. They also help keep you from being thrown against the inside of the vehicle, against other passengers, or out of the vehicle. When worn properly, seat belts also keep your body properly positioned in a crash so that you can take full advantage of the additional protection provided by the airbags.

In addition, seat belts help protect you in almost every type of crash, including:

- frontal impacts
- side impacts
- rear impacts
- rollovers

About Your Seat Belts

WARNING

Not wearing a seat belt properly increases the chance of serious injury or death in a crash, even though your vehicle has airbags.

Be sure you and your passengers always wear seat belts and wear them properly.

WARNING: Seat belts are designed to bear upon the bony structure of the body, and should be worn low across the front of the pelvis or the pelvis, chest and shoulders, as applicable; wearing the lap section of the belt across the abdominal area must be avoided.

WARNING: Seat belts should be adjusted as firmly as possible, consistent with comfort, to provide the protection for which they have been designed. A slack belt will greatly reduce the protection afforded to the wearer.

WARNING: Belts should not be worn with straps twisted.

WARNING: Each belt assembly must only be used by one occupant; it is dangerous to put a belt around a child being carried on the occupant's lap.

■ Lap/shoulder seat belts

All five seating positions are equipped with lap/shoulder seat belts with emergency locking retractors. In normal driving the retractor lets you move freely while keeping some tension on the belt. During a collision or sudden stop the retractor locks to restrain your body.

⌘ About Your Seat Belts

Seat belts cannot completely protect you in every crash. But in most cases, seat belts can reduce your risk of serious injury.

Most countries require you to wear seat belts. Take time to familiarize with the legal requirements of the countries in which you will drive.

The emergency locking retractor may lock if you lean forward too quickly. Slower movements will allow the belt to extend fully without locking.

Continued

■ Proper use of seat belts

Follow these guidelines for proper use:

- All occupants should sit upright, well back in the seat, and remain in that position for the duration of the trip. Slouching and leaning reduces the effectiveness of the belt and can increase the chance of serious injury in a crash.
- Never place the shoulder part of a lap/shoulder seat belt under your arm or behind your back. This could cause very serious injuries in a crash.
- Two people should never use the same seat belt. If they do, they could be very seriously injured in a crash.
- Do not put any accessories on the seat belts. Devices intended to improve comfort or reposition the shoulder part of a seat belt can reduce the protective capability and increase the chance of serious injury in a crash.

Seat Belt Reminder

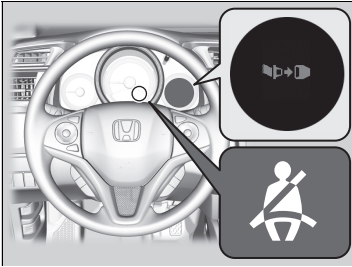

■ Front seats

Your vehicle monitors the front seat belt use. If the ignition switch is turned to ON *¹ before the driver's seat belt is fastened, the indicator will blink. If the driver does not fasten the belt, the indicator will remain on.

The beeper will also periodically sound and the indicator will blink while driving until the driver's seat belt is fastened.

⊗ Seat Belt Reminder

The indicator will also come on if a front passenger does not fasten their seat belt within six seconds after the ignition switch is turned to ON *¹.

The beeper will also periodically sound and the indicator will blink while driving until the front passenger's seat belt is fastened.

When no one is sitting in the front passenger's seat, or a child or small adult is riding there, the indicator will not come on.

If the indicator comes on or the beeper sounds with no front passenger, or with a passenger wearing the seat belt, something may be interfering with the occupant detection sensor. Check if:

- Heavy items are on the seat.
- A cushion is placed on the seat.
- A rear passenger is pushing or pulling on the back of the front passenger's seat.
- The front passenger is not sitting properly.

If none of these conditions exist, have your vehicle checked by a dealer as soon as possible.

*1: Models with the keyless access system have an **ENGINE START/STOP** button instead of an ignition switch.

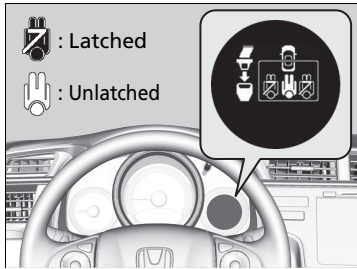

■ Rear seats

Your vehicle monitors rear seat belt use. A multi-information display notifies you if any of the rear seat belts are used.

With the ignition switch in ON *1, the display appears when:

- Either rear door is opened and closed.
- Any rear passenger latches or unlatches their seat belt.

The display also appears and the beeper sounds if any rear passenger's seat belt is unlatched while driving.

To see the display again, press the /▼ button repeatedly.

*1 : Models with the keyless access system have an **ENGINE START/STOP** button instead of an ignition switch.

Automatic Seat Belt Tensioners

The front and rear outer seats are equipped with automatic seat belt tensioners to enhance safety.

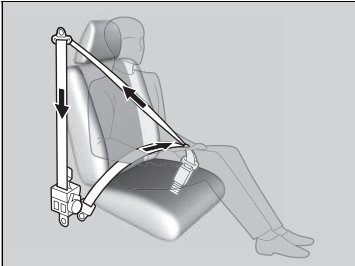

The tensioners automatically tighten the front and rear outer seat belts during a moderate-to-severe frontal collision, sometimes even if the collision is not severe enough to inflate the front airbags.

Automatic Seat Belt Tensioners

The seat belt tensioners can only operate once. If a tensioner is activated, the SRS indicator will come on. Have a dealer replace the tensioner and thoroughly inspect the seat belt system as it may not offer protection in a subsequent crash.

During a moderate-to-severe side impact, the tensioner on that side of the vehicle also activates.

Fastening a Seat Belt

After adjusting a front seat to the proper position, and while sitting upright and well back in the seat:

➤ **Adjusting the Seats** P. 183

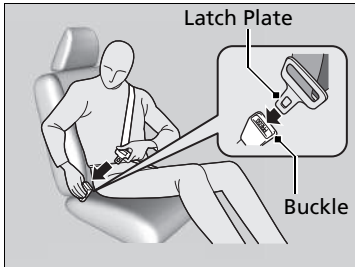
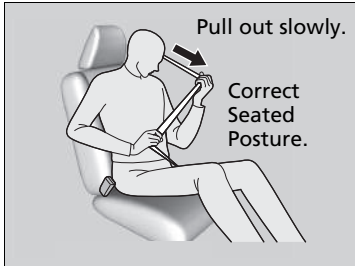

1. Pull the seat belt out slowly.

2. Insert the latch plate into the buckle, then tug on the belt to make sure the buckle is secure.

▶ Make sure that the belt is not twisted or caught on anything.

Fastening a Seat Belt

No one should sit in a seat with an inoperative seat belt or one that does not appear to be working correctly. Using a seat belt that is not working properly may not protect the occupant in a crash. Have a dealer check the belt as soon as possible.

Never insert any foreign objects into the buckle or retractor mechanism.

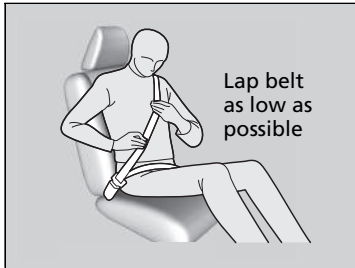

3. Position the lap part of the belt as low as possible across your hips, then pull up on the shoulder part of the belt so the lap part fits snugly. This lets your strong pelvic bones take the force of a crash and reduces the chance of internal injuries.
4. If necessary, pull up on the belt again to remove any slack, then check that the belt rests across the centre of your chest and over your shoulder. This spreads the forces of a crash over the strongest bones in your upper body.

Fastening a Seat Belt

⚠ WARNING

Improperly positioning the seat belts can cause serious injury or death in a crash.

Make sure all seat belts are properly positioned before driving.

To release the belt, push the red **PRESS** button then guide the belt by hand until it has retracted completely.

When exiting the vehicle, be sure the belt is out of the way and will not get caught by closing the door.

■ Adjusting the Shoulder Anchor

The front seats have adjustable shoulder anchors to accommodate taller and shorter occupants.

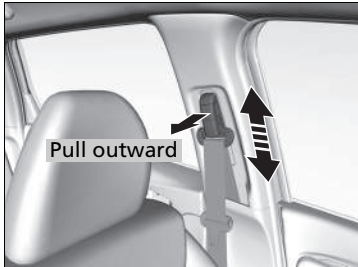

1. Move the anchor up and down while pulling the release outward.
2. Position the anchor so that the belt rests across the centre of your chest and over your shoulder.

▣ Adjusting the Shoulder Anchor

The shoulder anchor height can be adjusted to four levels. If the belt contacts your neck, lower the height one level at a time.

After an adjustment, make sure that the shoulder anchor position is secure.

Seat Belt with Detachable Anchor

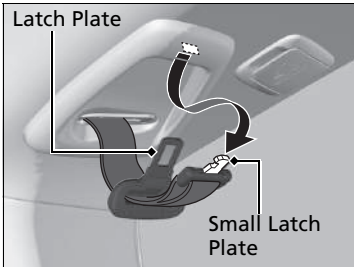

1. Pull out the seat belt's small latch plate and the latch plate from each holding slot in the ceiling.

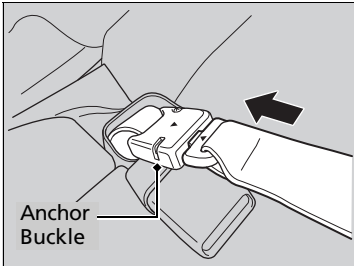

2. Line up the triangle marks on the small latch plate and anchor buckle. Make sure the seat belt is not twisted. Attach the belt to the anchor buckle.

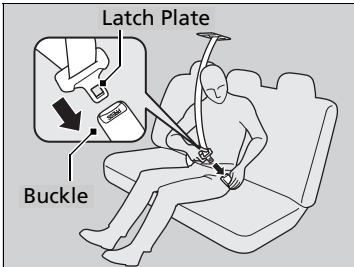

3. Insert the latch plate into the buckle. Properly fasten the seat belt the same way you fasten the lap/shoulder seat belt.

Seat Belt with Detachable Anchor

⚠ WARNING

Using the seat belt with the detachable anchor unlatched increases the chance of serious injury or death in a crash.

Before using the seat belt, make sure the detachable anchor is correctly latched.

To unlatch the detachable anchor, insert the latch plate into the slot on the side of the anchor buckle.

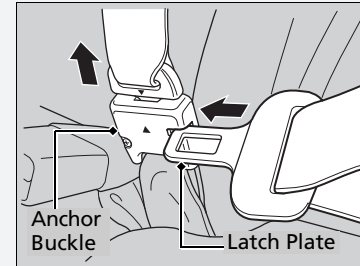

■ Advice for Pregnant Women

If you are pregnant, the best way to protect yourself and your unborn child when driving or riding in a vehicle is to always wear a seat belt and keep the lap part of the belt as low as possible across the hips.

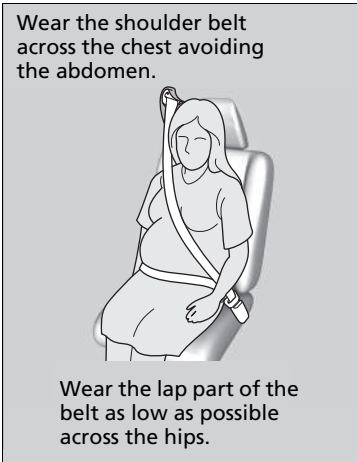

▣ Advice for Pregnant Women

Each time you have a checkup, ask your doctor if it is okay for you to drive.

To reduce the risk of injuries to both you and your unborn child that can be caused by an inflating front airbag:

- When driving, sit upright and adjust the seat as far back as possible while allowing full control of the vehicle.
- When sitting in the front passenger's seat, adjust the seat as far back as possible.

Seat Belt Inspection

Regularly check the condition of your seat belts as follows:

- Pull each belt out fully, and look for frays, cuts, burns, and wear.
- Check that the latches work smoothly and the belts retract easily.
 - ▶ If a belt does not retract easily, cleaning the belt may correct the problem. Only use a mild soap and warm water. Do not use bleach or cleaning solvents. Make sure the belt is completely dry before allowing it to retract.

Any belt that is not in good condition or working properly will not provide proper protection and should be replaced as soon as possible.

A belt that has been worn during a crash may not provide the same level of protection in a subsequent crash. Have your seat belts inspected by a dealer after any collision.

Seat Belt Inspection

WARNING

Not checking or maintaining seat belts can result in serious injury or death if the seat belts do not work properly when needed.

Check your seat belts regularly and have any problem corrected as soon as possible.

WARNING: No modifications or additions should be made by the user which will either prevent the seat belt adjusting devices from operating to remove slack, or prevent the seat belt assembly from being adjusted to remove slack.

WARNING: It is essential to replace the entire assembly after it has been worn in a severe impact even if damage to the assembly is not obvious.

WARNING: Care should be taken to avoid contamination of the webbing with polishes, oils and chemicals, and particularly battery acid. Cleaning may safely be carried out using mild soap and water. The belt should be replaced if webbing becomes frayed, contaminated or damaged.

■ Anchorage points

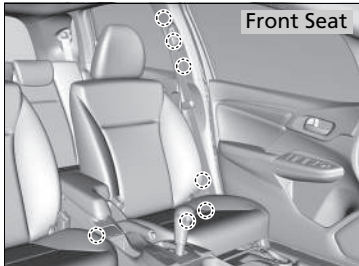

When replacing the seat belts, use the anchorage points shown in the images. The front seat has a lap/shoulder belt.

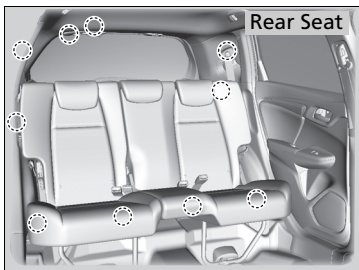

The rear seat has three lap/shoulder belts.

Airbag System Components

The front, front side, and side curtain airbags are deployed according to the direction and severity of impact. The airbag system includes:

- Two SRS (Supplemental Restraint System) front airbags. The driver's airbag is stored in the centre of the steering wheel; the front passenger's airbag is stored in the dashboard. Both are marked **SRS AIRBAG**.
- Two side airbags, one for the driver and one for a front passenger. The airbags are stored in the outer edges of the seat-backs. Both are marked **SIDE AIRBAG**.
- Two side curtain airbags, one for each side of the vehicle. The airbags are stored in the ceiling, above the side windows. The front and rear pillars are marked **SIDE CURTAIN AIRBAG**.
- An electronic control unit that continually monitors and records information about the sensors, the airbag activators, the seat belt tensioners, and driver and front passenger seat belt use when the ignition switch is in ON *1.
- Automatic front seat belt tensioners.
- Impact sensors that can detect a moderate-to-severe front or side collision.
- An indicator on the instrument panel that alerts you to a possible problem with your airbag system or seat belt tensioners.
- An indicator on the dashboard that alerts you that the passenger's front airbag has been turned off.

*1: Models with the keyless access system have an **ENGINE START/STOP** button instead of an ignition switch.

■ Important facts about your airbags

Airbags can pose serious hazards. To do their job, airbags must inflate with tremendous force. So, while airbags help save lives, they can cause burns, bruises, and other minor injuries, sometimes even fatal ones if occupants are not wearing their seat belts properly and sitting correctly.

What you should do: Always wear your seat belt properly, and sit upright and as far back from the steering wheel as possible while allowing full control of the vehicle. A front passenger should move their seat as far back from the dashboard as possible.

Remember, however, that no safety system can prevent all injuries or deaths that can occur in a severe crash, even when seat belts are properly worn and the airbags deploy.

Do not place hard or sharp objects between yourself and a front airbag.

Carrying hard or sharp objects on your lap, or driving with a pipe or other sharp object in your mouth, can result in injuries if your front airbag inflates.

Do not attach or place objects on the front airbag covers. Objects on the covers marked **SRS AIRBAG** could interfere with the proper operation of the airbags or be propelled inside the vehicle and hurt someone if the airbags inflate.

▣ Important facts about your airbags

Do not attempt to deactivate your airbags. Together, airbags and seat belts provide the best protection.

When driving, keep hands and arms out of the deployment path of the front airbag by holding each side of the steering wheel. Do not cross an arm over the airbag cover.

Types of Airbags

Your vehicle is equipped with three types of airbags:

- **Front airbags:** Airbags in front of the driver's and front passenger's seats.
- **Side airbags:** Airbags in the driver's and front passenger's seat-backs.
- **Side curtain airbags:** Airbags above the side windows.

Each is discussed in the following pages.

Front Airbags (SRS)

The front SRS airbags inflate in a moderate-to-severe frontal collision to help to protect the head and chest of the driver and/or front passenger.

SRS (Supplemental Restraint System) indicates that the airbags are designed to supplement seat belts, not replace them. Seat belts are the occupant's primary restraint system.

Housing Locations

The front airbags are housed in the centre of the steering wheel for the driver, and in the dashboard for the front passenger. Both airbags are marked **SRS AIRBAG**.

*1: Models with the keyless access system have an **ENGINE START/STOP** button instead of an ignition switch.

Types of Airbags

The airbags can inflate whenever the ignition switch is in ON *1.

After an airbag inflates in a crash, you may see a small amount of smoke. This is from the combustion process of the inflator material and is not harmful. People with respiratory problems may experience some temporary discomfort. If this occurs, get out of the vehicle as soon as it is safe to do so.

■ Operation

Front airbags are designed to inflate during moderate-to-severe frontal collisions. When the vehicle decelerates suddenly, the sensors send information to the control unit which signals one or both front airbags to inflate.

A frontal collision can be either head-on or angled between two vehicles, or when a vehicle crashes into a stationary object, such as a concrete wall.

■ How the Front Airbags Work

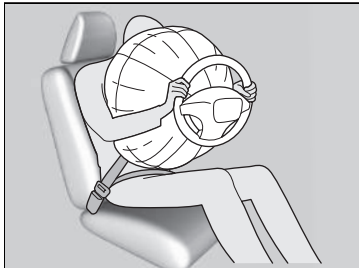

While your seat belt restrains your torso, the front airbag provides supplemental protection for your head and chest.

The front airbags deflate immediately so that they won't interfere with the driver's visibility or the ability to steer or operate other controls.

The total time for inflation and deflation is so fast that most occupants are not aware that the airbags deployed until they see them lying in front of them.

⌘ How the Front Airbags Work

Although the driver's and front passenger's airbags normally inflate within a split second of each other, it is possible for only one airbag to deploy. This can happen if the severity of a collision is at the margin, or threshold, that determines whether or not the airbags will deploy. In such cases, the seat belt will provide sufficient protection, and the supplemental protection offered by the airbag would be minimal.

■ When front airbags should not deploy

Minor frontal crashes: Front airbags were designed to supplement seat belts and help save lives, not to prevent minor scrapes, or even broken bones that might occur during a less than moderate-to-severe frontal crash.

Side impacts: Front airbags can provide protection when a sudden deceleration causes a driver or front passenger to move towards the front of the vehicle. Side airbags and side curtain airbags have been specifically designed to help to reduce the severity of injuries that can occur during a moderate-to-severe side impact which can cause the driver or passenger to move towards the side of the vehicle.

Rear impacts: Head restraints and seat belts are your best protection during a rear impact. Front airbags cannot provide any significant protection and are not designed to deploy in such collisions.

Rollovers: Seat belts, and in vehicles equipped with a rollover sensor, side airbags, and side curtain airbags offer the best protection in a rollover. Because front airbags could provide little if any protection, they are not designed to deploy during a rollover.

■ When front airbags deploy with little or no visible damage

Because the airbag system senses sudden deceleration, a strong impact to the vehicle framework or suspension might cause one or more of the airbags to deploy. Examples include running into a curb, the edge of a hole, or other low fixed object that causes a sudden deceleration in the vehicle chassis. Since the impact is underneath the vehicle, damage may not be readily apparent.

■ When front airbags may not deploy, even though exterior damage appears severe

Since crushable body parts absorb crash energy during an impact, the amount of visible damage does not always indicate proper airbag operation. In fact, some collisions can result in severe damage but no airbag deployment because the airbags would not have been needed or would not have provided protection even if they had deployed.

Passenger Front Airbag Off System

If it is unavoidable to install a rear-facing child restraint system in the front passenger seat, you must manually deactivate the passenger front airbag system, using the ignition key or the built-in key.

Passenger front airbag ON/OFF switch

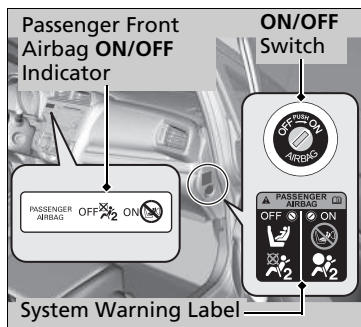

When the passenger front airbag **ON/OFF** switch is in:

OFF: The passenger front airbag is deactivated. The passenger front airbag does not inflate during a severe frontal crash that inflates driver's front airbag.

The passenger front airbag off indicator stays on as a reminder.

ON: The passenger front airbag is activated. The passenger front airbag on indicator comes on and remains on for about 60 seconds.

To deactivate the passenger front airbag system

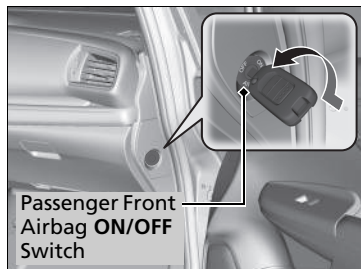

1. Set the parking brake, and turn the ignition switch to LOCK **0***1. Remove the key.
2. Open the front passenger's door.
3. Insert the key to the passenger front airbag **ON/OFF** switch.
 - ▶ The switch is located at the side panel of the front passenger side instrument panel.
4. Turn the key to **OFF**, and remove it from the switch.

*1 : Models with the keyless access system have an **ENGINE START/STOP** button instead of an ignition switch.

Passenger Front Airbag Off System

WARNING

The passenger front airbag system must be turned off, if it is not avoidable to put a rear-facing child restraint system in the front passenger seat.

If the front passenger airbag inflates, it can hit the rear-facing child restraint system with enough force to kill or cause a very serious injury to the infant.

WARNING

Make sure to turn on the passenger front airbag system when a rear-facing child restraint system is not used on the front passenger seat.

Leaving the passenger front airbag system deactivated can result in serious injury or death in a crash.

■ Passenger front airbag off indicator

When the passenger front airbag system is activated, the indicator goes off after a few seconds when you turn the ignition switch to ON *1.

When the passenger front airbag system is deactivated, the indicator stays on, or goes off momentarily and comes back on.

■ Passenger front airbag off system label

The label is located at the side panel of the front passenger side instrument panel.

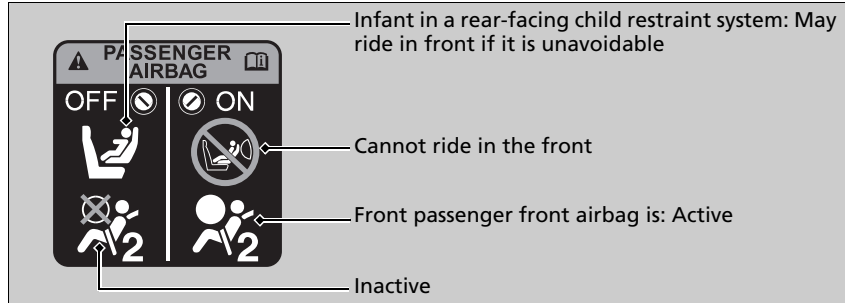

▶▶ Passenger Front Airbag Off System

NOTICE

- Use your vehicle's ignition key/built-in key to turn the passenger front airbag **ON/OFF** switch. If you use a different key, the switch can be damaged, or the passenger front airbag system may not work properly.
- Do not close the door or apply excessive load on the ignition key/built-in key while the key is in the passenger front airbag **ON/OFF** switch. The switch or the key can be damaged.

We strongly recommend that you must not install a rear-facing child restraint system in the front passenger seat.

▶ Protecting Infants P. 66

It is your responsibility to change the setting of the passenger front airbag system to **OFF** when you put a rear-facing child restraint system on the front passenger seat.

When a rear-facing child restraint system is not in use in the front passenger seat, turn the system back on.

*1: Models with the keyless access system have an **ENGINE START/STOP** button instead of an ignition switch.

Side Airbags

The side airbags help to protect the upper torso and pelvis of the driver or a front passenger during a moderate-to-severe side impact.

The side airbags are especially hazardous if a child is sitting in the front seat.

Housing Locations

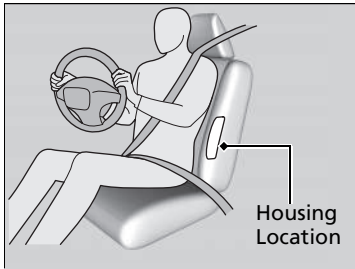

The side airbags are housed in the outside edge of the driver's and passenger's seat-backs.

Both are marked **SRS AIRBAG**.

Side Airbags

WARNING



Leaning over the front door can result in serious injury or death if the side airbag inflates.

Always sit upright with their back against the seat-back.

Do not attach accessories on or near the side airbags. They can interfere with the proper operation of the airbags, or hurt someone if an airbag inflates.

If the impact is on the passenger's side, the airbag may not deploy when there is no passenger in the front passenger seat.

■ Operation

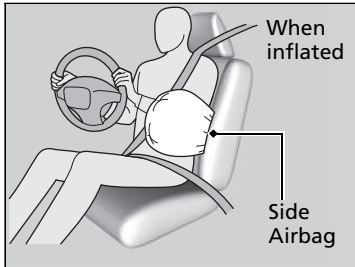

When the sensors detect a moderate-to-severe side impact, the control unit signals the side airbag on the impact side to immediately inflate.

■ When a side airbag deploys with little or no visible damage

Because the airbag system senses sudden acceleration, a strong impact to the side of the vehicle's framework can cause a side airbag to deploy. In such cases, there may be little or no damage, but the side impact sensors detected a severe enough impact to deploy the airbag.

■ When a side airbag may not deploy, even though visible damage appears severe

It is possible for a side airbag to not deploy during an impact that results in apparently severe damage. This can occur when the point of impact was towards the far front or rear of the vehicle, or when the vehicle's crushable body parts absorbed most of the crash energy. In either case, the side airbag would not have been needed nor provided protection even if it had deployed.

⌘ Side Airbags

Do not cover or replace the front seat-back covers without consulting a dealer. Improperly replacing or covering front seat-back covers can prevent your side airbags from properly deploying during a side impact.

Do not let the front passenger lean sideways with their head in the deployment path of the side airbag. An inflating side airbag can strike with strong force and seriously injure the passenger.

Side Curtain Airbags

The side curtain airbags help to protect the heads of the driver and passengers in outer seating positions during a moderate-to-severe side impact.

Housing Locations

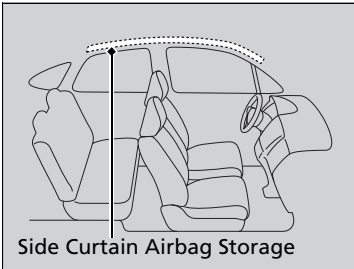

The side curtain airbags are located in the ceiling above the side windows on both sides of the vehicle.

Operation

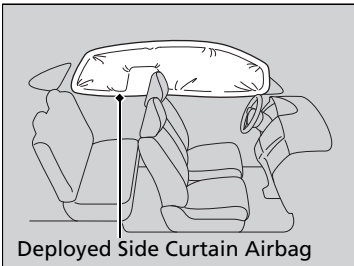

When side curtain airbags deploy in a frontal collision

One or both side curtain airbags may inflate in a moderate-to-severe angled frontal collision.

In this case, the side curtain airbags will deploy slightly after the front airbags.

Side Curtain Airbags

The side curtain airbags are most effective when an occupant is wearing their seat belt properly and sitting upright, well back in their seat.

Do not attach any objects to the side windows or roof pillars as they can interfere with the proper operation of the side curtain airbags.

Do not put a coat hanger or hard objects on a coat hook. This could result in injuries if your side curtain airbag inflates.

Airbag System Indicators

If a problem occurs in the airbag system, the SRS indicator comes on and a message appears on the multi-information display.

SRS (Supplemental Restraint System) Indicator

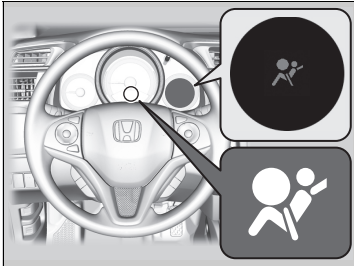

■ When the ignition switch is turned on *1

The indicator comes on for a few seconds, then goes off. This tells you the system is working properly.

If the indicator comes on at any other time, or does not come on at all, have the system checked by a dealer as soon as possible. If you don't, your airbags and seat belt tensioners may not work properly when they are needed.

*1: Models with the keyless access system have an **ENGINE START/STOP** button instead of an ignition switch.

SRS (Supplemental Restraint System) Indicator

WARNING

Ignoring the SRS indicator can result in serious injury or death if the airbag systems or tensioners do not work properly.

Have your vehicle checked by a dealer as soon as possible if the SRS indicator alerts you to a possible problem.

WARNING

Remove the rear-facing child restraint system immediately from the front passenger seat if the SRS indicator comes on. Even if the passenger front airbag has been deactivated, do not ignore the SRS indicator.

The SRS system may have a fault which could cause the passenger front airbag to be activated, causing serious injury or death.

■ Passenger Front Airbag Off Indicator

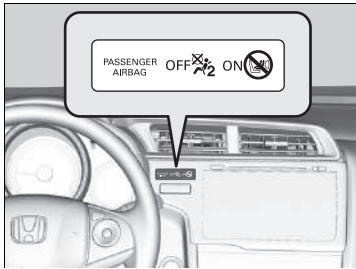

■ When the passenger airbag off indicator comes on

The indicator stays on while the passenger's front airbag system is deactivated.

When a rear-facing child restraint system is not in use in the front passenger seat, manually turn the system back on. The indicator should go off.

Airbag Care

You do not need to, and should not, perform any maintenance on or replace any airbag system components yourself. However, you should have your vehicle inspected by a dealer in the following situations:

■ When the airbags have deployed

If an airbag has inflated, the control unit and other related parts must be replaced. Similarly, once an automatic seat belt tensioner has been activated, it must be replaced.

■ When the vehicle has been in a moderate-to-severe collision

Even if the airbags did not inflate, have your dealer inspect the following: front seat belt tensioners, and each seat belt that was worn during the crash.

⚠ Airbag Care

The removal of airbag components from the vehicle is prohibited.

In case of malfunction, or shutdown, or after the airbag inflation/seat belt tensioner operation, ask a qualified personnel for handling.

We recommend against the use of salvaged airbag system components, including the airbag, tensioners, sensors, and control unit.

Protecting Child Passengers

Each year, many children are injured or killed in vehicle crashes because they are either unrestrained or not properly restrained. In fact, vehicle accidents are the number one cause of death of children ages 12 and under.

To reduce the number of child deaths and injuries, infants and children should be properly restrained when they ride in a vehicle.

Protecting Child Passengers

WARNING

Children who are unrestrained or improperly restrained can be seriously injured or killed in a crash.

Any child too small for a seat belt should be properly restrained in an approved child restraint system. A larger child should be properly restrained with a seat belt, using a booster seat if necessary.

In many countries, the law requires all children aged 12 and under, and whose height are shorter than 150 cm (60 inches) be properly restrained in a rear seat.

In many countries, it is required to use an officially approved and suitable child restraint system for transporting a child on any passenger seat. Check your local legal requirements.

European models

Child restraint systems must meet the UN-ECE R44 or the regulations of the subject countries.

 **Selecting a Child Restraint System** P. 69

Except European models

We recommend that child restraint systems meet the UN-ECE R44 or the regulations of the subject countries.

Children should sit properly restrained in a rear seat. This is because:

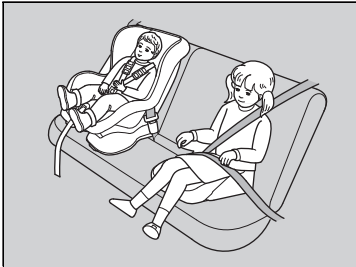

- An inflating front or side airbag can injure or kill a child sitting in the front seat.
- A child in the front seat is more likely to interfere with the driver's ability to safely control the vehicle.
- Statistics show that children of all sizes and ages are safer when they are properly restrained in a rear seat.

- Any child who is too small to wear a seat belt must be properly restrained in an approved child restraint system that is properly secured to the vehicle using the lap belt portion of the lap/shoulder belt.
- Never hold a child on your lap because it is impossible to protect them in the event of a collision.
- Never put a seat belt over yourself and a child. During a crash, the belt would likely press deep into the child and cause serious or fatal injuries.
- Never let two children use the same seat belt. Both children could be very seriously injured in a crash.

► Protecting Child Passengers

Front Passenger's Sunvisor

⚠ WARNING



NEVER use a rearward facing child restraint on a seat protected by an **ACTIVE AIRBAG** in front of it, **DEATH** or **SERIOUS INJURY** to the **CHILD** can occur.

- Do not allow children to operate the doors, windows or seat adjustments.
- Do not leave children in the vehicle unattended, especially in hot weather when the inside of the vehicle can get hot enough to kill them. They could also activate vehicle controls causing it to move unexpectedly.

▶▶ Protecting Child Passengers

To remind you of the passenger's front airbag hazards and child safety, your vehicle has the warning label on the sun visor. Please read and follow the instructions on the label.

▶ **Safety Labels** P. 82

WARNING: Use the power window lock button to prevent children from opening the windows. Using this feature will prevent children from playing with the windows, which could expose them to hazards or distract the driver.

▶ **Opening/Closing the Power Windows**
P. 159

WARNING: Always take the ignition key with you whenever you leave the vehicle alone (with other occupants).

Safety of Infants and Small Children

■ Protecting Infants

An infant must be properly restrained in a rear-facing, reclining child restraint system until the infant reaches the restraint system maker's weight or height limit for the seat, and the infant is at least one year old.

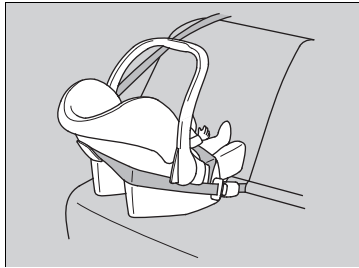

■ Positioning a rear-facing child restraint system

Child restraint system must be placed and secured in a rear seating position.

▶▶ Protecting Infants

⚠ WARNING

Placing a rear-facing child restraint system in the front seat can result in serious injury or death if the passenger's front airbag inflates.

Always place a rear-facing child restraint system in the back seat, not the front.

As required by UN-ECE R94 Regulation:

⚠ WARNING



NEVER use a rearward facing child restraint on a seat protected by an ACTIVE AIRBAG in front of it, DEATH or SERIOUS INJURY to the CHILD can occur.

When properly installed, a rear-facing child restraint system may prevent the driver or a front passenger from moving their seat all the way back, or from locking their seat-back in the desired position.

☒ Protecting Infants

If the passenger's front airbag inflates, it can hit the rear-facing child restraint system with great force, which can dislodge or strike the system, and seriously injure the child.

Rear-facing child restraint systems should never be installed in a front facing position.

Always refer to the child restraint system manufacturer's instructions before installation.

If it is absolutely unavoidable to install a rear-facing child restraint system in the front passenger seat, manually turn off the passenger front airbag system.

☒ **Passenger Front Airbag Off System** P. 54

■ Protecting Smaller Children

If a child is at least one year old and within the weight range indicated by the child restraint system manufacturer, the child should be properly restrained in a firmly secured front facing child restraint system.

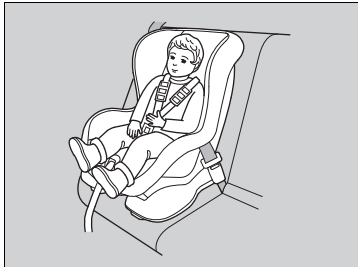

■ Front facing child restraint system placement

We strongly recommend placing a front facing child restraint system in a rear seating position.

Placing a front facing child restraint system in the front seat can be hazardous. A rear seat is the safest place for a child.

▶▶ Protecting Smaller Children

⚠ WARNING

Placing a front facing child restraint system in the front seat can result in serious injury or death if the front airbag inflates.

If you must place a front facing child restraint system in front, move the vehicle seat as far back as possible, and properly restrain the child.

Educate yourself about the laws and regulations regarding child restraint system use where you are driving, and follow the child restraint system manufacturer's instructions.

Many experts recommend use of a rear-facing child restraint system for a child up to two years old, if the child's height and weight are appropriate for a rear-facing child restraint system.

■ Selecting a Child Restraint System

Some child restraint systems are lower anchorage compatible. Some have a rigid-type connector, while others have a flexible-type connector. Both are equally easy to use. Some existing and previously owned child restraint systems can only be installed using the seat belt. Whichever type you choose, follow the child restraint system manufacturer's use and care instructions as well as the instructions in this manual. Proper installation is key to maximizing your child's safety.

The flexible type may not be available in your country.

In seating positions and vehicles not equipped with lower anchorages, install a child restraint system using the seat belt and a top tether for added security. This is because all child restraint systems must be secured with a lap belt or the lap part of a lap/shoulder belt when not using the lower anchorage system. In addition, the child restraint system manufacturer may advise that a seat belt be used to attach an ISO FIX restraint system once a child reaches a specified weight. Please read the child restraint system owner's manual for proper installation instructions.

■ Important consideration when selecting a child restraint system

Make sure the child restraint system meets the following three requirements:

- The child restraint system is the correct type and size for the child.
- The child restraint system is the correct type for the seating position.
- Child restraint system is compliant with safety standard. We recommend the child restraint system with the UN-ECE R44 or the regulations of the subject countries. Look for the approval mark on the system and the manufacturer's statement of compliance on the box.

▶▶ Selecting a Child Restraint System

Installation of a lower anchorage-compatible child restraint system is simple.

Lower anchorage-compatible child restraint systems have been developed to simplify the installation process and reduce the likelihood of injuries caused by incorrect installation.

■ The Recommended Child Restraint Systems for EU Countries

Various types of child restraint systems are available. Not all types are suitable for your vehicle. Please refer to the table below to select which category of child restraint system can be used on each seating position.

Mass group		Seating position			
		Front passenger		Rear passenger	
		Passenger front airbag ON/OFF switch position		Rear outboard	Rear centre
OFF	ON				
group 0	Up to 10 kg	U ^{*1,*2,*4,*5}	X	U ^{*3,*4}	U ^{*3,*4}
group 0+	Up to 13 kg	U ^{*1,*2,*4,*5}	X	IL (Honda BABY-SAFE ISOFIX), or U ^{*3,*4}	U ^{*3,*4}
group I	9 kg to 18 kg	U ^{*1,*2,*4,*5}	UF ^{*1,*2,*4,*5}	IUF (Size class A, B1, B) or U ^{*3,*4}	U ^{*3,*4}
group II	15 kg to 25 kg	U ^{*1,*2,*4,*5}	UF ^{*1,*2,*4,*5}	L (Honda KID FIX XP SICT) or U ^{*3,*4}	U ^{*3,*4}
group III	22 kg to 36 kg	U ^{*1,*2,*4,*5}	UF ^{*1,*2,*4,*5}	L (Honda KID FIX XP SICT) or U ^{*3,*4}	U ^{*3,*4}

IL: Suitable for particular ISO FIX child restraint systems (CRS) given in this list.

IUF: Suitable for front facing ISOFIX child restraints system of universal category approved for use in this mass group.

L: Suitable for particular child restraint systems given in this table. These restraints may be of the “specific vehicle,” “restricted,” or “semi-universal” category.

U: Suitable for “universal” category restraints approved for use in this mass group.

UF: Suitable for front facing “universal” category restraints approved for use in this mass group.

X: Seat position not suitable for children in this mass group.

Models with front seat height adjustment

- *1: Move the front seat to its slide rail rearmost position.
- *2: Adjust seat height to the most upper end position.
- *3: Adjust seat-back angle to the upright position (Front most lock position).

Models without front seat height adjustment

- *4: Adjust seat-back angle to the upright position (Front most lock position).
- *5: Move the front seat to its slide rail rearmost position.

	Seating position in the vehicle		
	Front seat	Rear outer seat	Rear centre seat
i-Size child restraint systems	X	i-U	X

i-U: Suitable for i-Size "universal" Child Restraint Systems for forward and rearward facing.

X: Seating position not suitable for i-Size "universal" Child Restraint systems.

A size class is specified for some child restraint systems. Make sure to check the size class as indicated on the manufacturer's instructions, package, and labels of the child restraint.

The particular child restraints in the table are Honda Genuine Parts. They are available from your dealer.

For a correct installation, please refer to the Child Restraint Instruction Manual.

■ Installing a Lower Anchorage-Compatible Child Restraint System

A lower anchorage-compatible child restraint system can be installed in either of the two outer rear seats. A child restraint system is attached to the lower anchorages with either the rigid or flexible type of connectors.

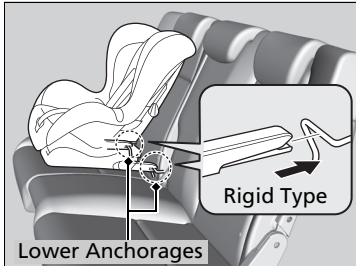
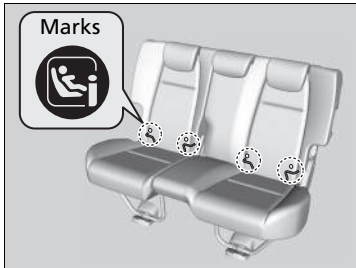

1. Locate the lower anchorages under the marks.
2. Make sure to lock the seat-back in the upright position.
3. Lower the head restraint to its lowest position.
4. Place the child restraint system on the vehicle seat then attach the child restraint system to the lower anchorages according to the instructions that came with the child restraint system.
 - ▶ When installing the child restraint system, make sure that the lower anchorages are not obstructed by the seat belt or any other object.

▣ Installing a Lower Anchorage-Compatible Child Restraint System

Some child restraint systems come with optional guide-cups, which avoid possible damage to the seat surface. Follow the manufacturer's instructions when using the guide-cups, and attach them to the lower anchorages as shown in the image.

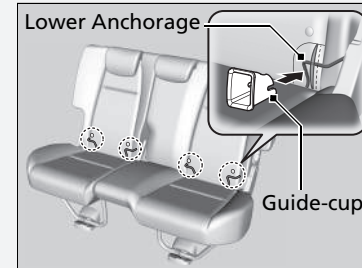

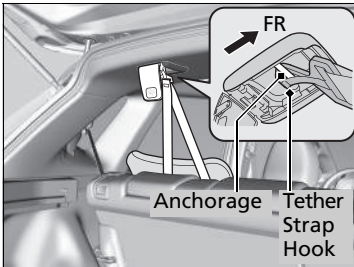
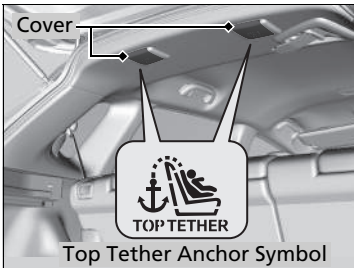
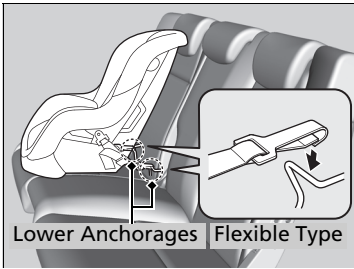

5. Open the tether anchorage cover.
6. Route the tether strap over the seat-back. Make sure the strap is not twisted.
7. Secure the tether strap hook onto the anchorage.
8. Tighten the tether strap as instructed by the child restraint system manufacturer.
9. Make sure the child restraint system is firmly secured by rocking it forward and back and side to side; little movement should be felt.
10. Make sure any unused seat belt that a child can reach is buckled.

► Installing a Lower Anchorage-Compatible Child Restraint System

For your child's safety, when using a child restraint system installed using the lower anchorage system, make sure that the restraint system is properly secured to the vehicle. A child restraint system that is not properly secured will not adequately protect a child in a crash and may cause injury to the child or other vehicle occupants.

The flexible type may not be available in your country.

WARNING: Never use a hook that does not come with a Top Tether anchor symbol when securing an installed child restraint system.

■ Installing a Child Restraint System with a Lap/Shoulder Seat Belt



1. Make sure to lock the seat-back in the upright position.
2. Lower the head restraint to its lowest position.
3. Place the child restraint system on the vehicle seat.
4. Route the seat belt through the child restraint system according to the child restraint system manufacturer's instructions, and insert the latch plate into the buckle.
 - Insert the latch plate fully until it clicks.

▣ Installing a Child Restraint System with a Lap/Shoulder Seat Belt

A child restraint system that is not properly secured will not adequately protect a child in a crash and may cause injury to the child or other vehicle occupants.

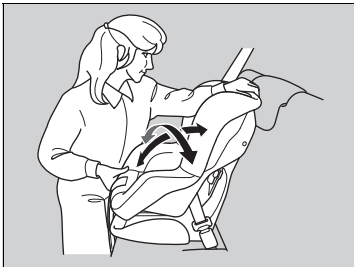
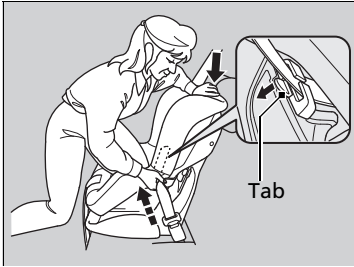

5. Push down the tab. Route the shoulder part of the belt into the slit at the side of the restraint.
6. Grab the shoulder part of the belt near the buckle, and pull up to remove any slack from the lap part of the belt.
 - ▶ When doing this, place your weight on child restraint system and push it into the vehicle seat.
7. Position the belt properly. Make sure the belt is not twisted.
 - ▶ When pulling down the tab, pull up the upper shoulder part of the belt to remove any slack from the belt.
8. Make sure the child restraint system is firmly secured by rocking it forward and back and side to side; little movement should be felt.
9. Make sure any unused seat belt that a child can reach is buckled.

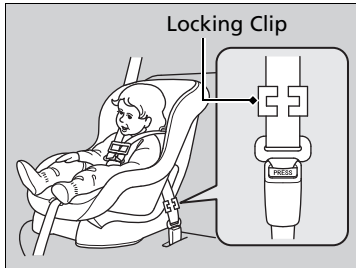

Except European models

If your child restraint system does not come with a mechanism that secures the belt, install a locking clip on the seat belt.

After going through the step 1 and 4, pull up the shoulder part of the belt and make sure there is no slack in the lap portion.

- 5.** Tightly grasp the belt near the latch plate.
Pinch both parts of the belt together so they do not slip through the latch plate.
Unbuckle the seat belt.
- 6.** Install the locking clip as shown in the image. Position the clip as close as possible to the latch plate.
- 7.** Insert the latch plate into the buckle. Go to step 8 and 9.

■ Adding Security with a Tether

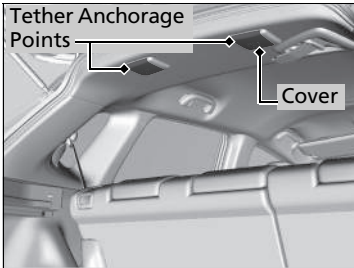

Two tether anchorage points are provided on the ceiling for rear outer seating positions. A child restraint system that is installed with a seat belt and comes with a tether can use the tether for additional security.

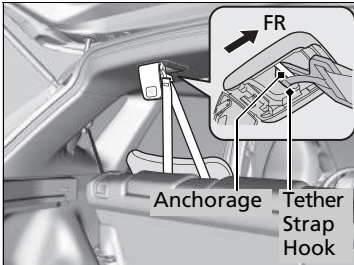

1. Locate the appropriate tether anchorage point.
2. Lower the head restraint to its lowest position.
3. Open the anchorage cover.
4. Route the tether strap over the seat-back. Make sure the strap is not twisted.
5. Secure the tether strap hook onto the anchorage.
6. Tighten the tether strap as instructed by the child restraint system manufacturer.

▣ Adding Security with a Tether

WARNING: Child restraint anchorages are designed to withstand only those loads imposed by correctly fitted child restraints. Under no circumstances are they to be used for adult seat belts, harnesses or for attaching other items or equipment to the vehicle.

Since a tether can provide additional security to the lap/shoulder seat belt installation, we recommend using a tether whenever one is available.

Safety of Larger Children

■ Protecting Larger Children

The following pages give instructions on how to check proper seat belt fit, what kind of booster seat to use if one is needed, and important precautions for a child who must sit in front.

■ Checking Seat Belt Fit

When a child is too big for a child restraint system, secure the child in a rear seat using the lap/shoulder seat belt. Have the child sit upright and all the way back, then answer the following questions.



■ Checklist

- Do the child's knees bend comfortably over the edge of the seat?
- Does the shoulder belt cross between the child's neck and arm?
- Is the lap part of the seat belt as low as possible, touching the child's thighs?
- Will the child be able to stay seated like this for the whole trip?

If you answer yes to all these questions, the child is ready to wear the lap/shoulder seat belt correctly. If you answer no to any question, the child needs to ride on a booster seat until the seat belt fits properly without a booster seat.

▶ Safety of Larger Children

⚠ WARNING

Allowing a child age 12 or under to sit in front can result in injury or death if the passenger's front airbag inflates.

If a larger child must ride in front, move the vehicle seat as far to the rear as possible, have the child sit up properly and wear the seat belt properly, using a booster seat if needed.

Booster Seats



If a lap/shoulder seat belt cannot be used properly, position the child in a booster seat in a rear seating position. For the child's safety, check that the child meets the booster seat manufacturer's recommendations.

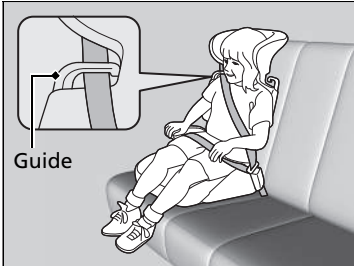

A back-rest is available for a specific booster seat. Install the back-rest to the booster seat and adjust it to the vehicle seat according to the booster seat manufacturer's instructions. Make sure the seat belt is properly routed through the guide at the shoulder of the back-rest and the belt does not touch and cross the child's neck.

Booster Seats

When installing a booster seat, make sure to read the instructions that came with it, and install the seat accordingly.

There are high- and low-type booster seats. Choose a booster seat that allows the child to wear the seat belt correctly.

■ Protecting Larger Children - Final Checks

Your vehicle has a rear seat where children can be properly restrained. If you ever have to carry a group of children, and a child must ride in front:

- Make sure you read and fully understand the instructions and safety information in this manual.
- Move the front passenger seat as far back as possible.
- Have the child sit upright and well back in the seat.
- Check that the seat belt is properly positioned so that the child is secure in the seat.

■ Monitoring child passengers

We strongly recommend that you keep an eye on child passengers. Even older, more mature children sometimes need to be reminded to fasten their seat belts and sit up properly.

Carbon Monoxide Gas

The engine exhaust from this vehicle contains carbon monoxide, a colourless, odourless, and highly toxic gas. As long as you properly maintain your vehicle, carbon monoxide gas will not get into the interior.

■ Have the exhaust system inspected for leaks whenever

- The exhaust system is making an unusual noise.
- The exhaust system may have been damaged.
- The vehicle is raised for an oil change.

When you operate a vehicle with the tailgate open, airflow can pull exhaust gas into the interior and create a hazardous condition. If you must drive with the tailgate open, open all the windows and set the heating and cooling system*/climate control system* as shown below.

1. Select the fresh air mode.
2. Select the  mode.
3. Set the fan speed to high.
4. Set the temperature control to a comfortable setting.

Adjust the heating and cooling system*/climate control system* in the same manner if you sit in your parked vehicle with the engine running.

☒ Carbon Monoxide Gas

⚠ WARNING

Carbon monoxide gas is toxic. Breathing it can cause unconsciousness and even kill you.

Avoid any enclosed areas or activities that expose you to carbon monoxide.

An enclosed area such as a garage can quickly fill up with carbon monoxide gas.

Do not run the engine with the garage door closed. Even when the garage door is open, drive out of the garage immediately after starting the engine.

* Not available on all models

Label Locations

These labels are in the locations shown. They warn you of potential hazards that can cause serious injury or death. Read these labels carefully.

If a label comes off or becomes hard to read, contact a dealer for a replacement.

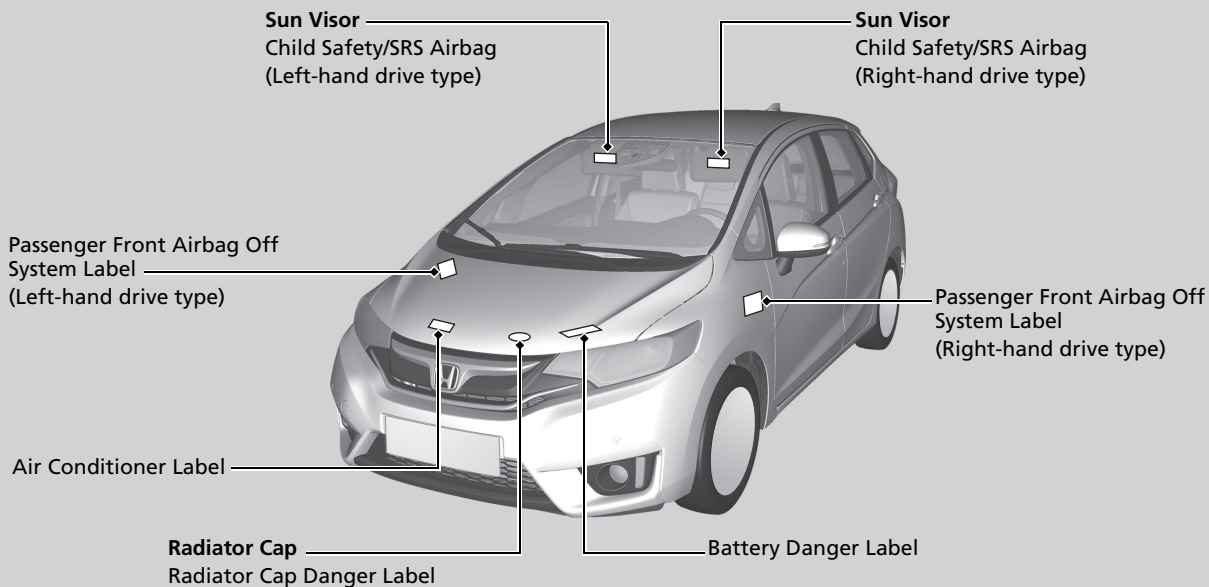



Instrument Panel







This chapter describes the buttons, indicators, and gauges that are used while driving.









Indicators	84
Multi-Information Display Warning and Information Messages.....	106
Gauges and Multi-Information Display	
Gauges.....	121
Multi-Information Display	122

Indicator	Name	On/Blinking	Explanation	Message
	Parking Brake and Brake System Indicator (Red)	<ul style="list-style-type: none"> • Comes on for a few seconds when you turn the ignition switch to ON II*1, then goes off if the parking brake has been released. • Comes on when the parking brake is applied, and goes off when it is released. • The beeper sounds and the indicator comes on if you drive with the parking brake not fully released. • Comes on when the brake fluid level is low. • Comes on if there is a problem with the brake system. 	<ul style="list-style-type: none"> • Comes on while driving - Make sure the parking brake is released. Check the brake fluid level. <ul style="list-style-type: none"> ➤ What to do when the indicator comes on while driving P. 561 • Comes on along with the ABS indicator - Have your vehicle checked by a dealer. <ul style="list-style-type: none"> ➤ If the Brake System Indicator (Red) Comes On P. 561 	







*1: Models with the keyless access system have an **ENGINE START/STOP** button instead of an ignition switch.

Indicator	Name	On/Blinking	Explanation	Message
	Brake System Indicator (Amber)	<ul style="list-style-type: none"> • Comes on for a few seconds when you turn the ignition switch to ON *1, then goes off. • Comes on if there is a problem with a component related to braking. 	<ul style="list-style-type: none"> • Stays on constantly - Have your vehicle checked by a dealer. 	 
		<ul style="list-style-type: none"> • Comes on if there is a problem with the City-Brake Active system. 	<ul style="list-style-type: none"> • Comes on along with the CTBA indicator - The City-Brake Active system does not activate. Have your vehicle checked by a dealer.  City-Brake Active system P. 450 	







*1: Models with the keyless access system have an **ENGINE START/STOP** button instead of an ignition switch.

Indicator	Name	On/Blinking	Explanation	Message
	Low Oil Pressure Indicator	<ul style="list-style-type: none"> • Comes on when you turn the ignition switch to ON *1, and goes off when the engine starts. • Comes on when the engine oil pressure is low. 	<ul style="list-style-type: none"> • Comes on while driving - Immediately stop in a safe place. <ul style="list-style-type: none"> ➤ If the Low Oil Pressure Indicator Comes On P. 560 	
	Malfunction Indicator Lamp	<ul style="list-style-type: none"> • Comes on when you turn the ignition switch to ON *1, and goes off when the engine starts. • Comes on if there is a problem with the emissions control system. • Blinks when a misfire in the engine's cylinders is detected. 	<ul style="list-style-type: none"> • Comes on while driving - Have your vehicle checked by a dealer. • Blinks while driving - Stop in a safe place where there are no flammable objects. Stop the engine for 10 minutes or more, and wait for it to cool down. Then, take your vehicle to a dealer. <ul style="list-style-type: none"> ➤ If the Malfunction Indicator Lamp Comes On or Blinks P. 561 • Shows the self-testing condition of the diagnostics of the emission control system. 	



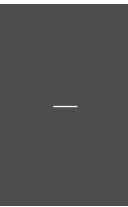





*1 : Models with the keyless access system have an **ENGINE START/STOP** button instead of an ignition switch.

Indicator	Name	On/Blinking	Explanation	Message
	Charging System Indicator	<ul style="list-style-type: none"> • Comes on when you turn the ignition switch to ON ^{*1}, and goes off when the engine starts. • Comes on when the battery is not charging. 	<ul style="list-style-type: none"> • Comes on while driving - Turn off the heating and cooling system*/ climate control system* and rear demister in order to reduce electricity consumption. <ul style="list-style-type: none"> ➤ If the Charging System Indicator Comes On P. 560 	
	Shift Lever Position Indicator*	<ul style="list-style-type: none"> • Indicates the current shift lever position. 	<ul style="list-style-type: none"> ➤ Shifting P. 396 	
	Transmission Indicator*	<ul style="list-style-type: none"> • Blinks if the transmission system has a problem. 	<ul style="list-style-type: none"> • Blinks while driving - Avoid sudden starts and acceleration and have your vehicle checked by a dealer immediately. 	





*1: Models with the keyless access system have an **ENGINE START/STOP** button instead of an ignition switch.

Indicator	Name	On/Blinking	Explanation	Message
	<p>M (7-speed manual shift mode) Indicator/Shift Indicator*</p>	<ul style="list-style-type: none"> Comes on when 7-speed manual shift mode is applied. 	<p> 7-Speed Manual Shift Mode P. 398</p>	
	<p>Seat Belt Reminder Indicator</p>	<ul style="list-style-type: none"> Comes on if you are not wearing a seat belt when you turn the ignition switch to ON *1. If the front passenger is not wearing a seat belt, the indicator comes on about a few seconds later. Blinks while driving if either you or the front passenger has not fastened a seat belt. The beeper sounds and the indicator blinks at regular intervals. 	<ul style="list-style-type: none"> The beeper stops and the indicator goes off when you and the front passenger fasten their seat belts. Stays on after you or the front passenger has fastened the seat belt - A detection error may have occurred in the sensor. Have your vehicle checked by a dealer. <p> Seat Belt Reminder P. 39</p>	







*1: Models with the keyless access system have an **ENGINE START/STOP** button instead of an ignition switch.

Indicator	Name	On/Blinking	Explanation	Message
	Low Fuel Indicator	<ul style="list-style-type: none"> • Comes on when the fuel reserve is running low (approximately 5.3 Litres/ 1.17 Imp gal left). • Blinks if there is a problem with the fuel gauge. 	<ul style="list-style-type: none"> • Comes on - Refuel your vehicle as soon as possible. • Blinks - Have your vehicle checked by a dealer. 	
	Anti-lock Brake System (ABS) Indicator	<ul style="list-style-type: none"> • Comes on for a few seconds when you turn the ignition switch to ON ^{*1}, then goes off. • If it comes on at any other time, there is a problem with the ABS. 	<ul style="list-style-type: none"> • Stays on constantly - Have your vehicle checked by a dealer. With this indicator on, your vehicle still has normal braking ability but no anti-lock function. <p>➤ Anti-lock Brake System (ABS) P. 448</p>	
	Supplemental Restraint System Indicator	<ul style="list-style-type: none"> • Comes on for a few seconds when you turn the ignition switch to ON ^{*1}, then goes off. • Comes on if a problem with any of the following is detected: <ul style="list-style-type: none"> - Supplemental restraint system - Side airbag system - Side curtain airbag system - Seat belt tensioner 	<ul style="list-style-type: none"> • Stays on constantly or does not come on at all - Have your vehicle checked by a dealer. 	







*1: Models with the keyless access system have an **ENGINE START/STOP** button instead of an ignition switch.

Indicator	Name	On/Blinking	Explanation	Message
 	Passenger Front Airbag On/Off Indicators	<ul style="list-style-type: none"> Both indicators come on for a few seconds when you turn the ignition switch to ON ^{*1}, then goes off after a system check up. When the passenger front airbag is active: The on indicator comes back on and remains on for about 60 seconds. When the passenger front airbag is inactive: The off indicator comes back on and stays on. This is a reminder that the passenger front airbag is deactivated. 	 Passenger Front Airbag Off System P. 54	



*1 : Models with the keyless access system have an **ENGINE START/STOP** button instead of an ignition switch.

Indicator	Name	On/Blinking	Explanation	Message
	Vehicle Stability Assist (VSA) System Indicator	<ul style="list-style-type: none"> • Comes on for a few seconds when you turn the ignition switch to ON *1, then goes off. • Blinks when VSA is active. • Comes on if there is a problem with the VSA or hill start assist system. 	<ul style="list-style-type: none"> • Stays on constantly - Have your vehicle checked by a dealer. <ul style="list-style-type: none"> ➤ Vehicle Stability Assist (VSA) System P. 440 ➤ Hill start assist system P. 388, 392 	 
	Vehicle Stability Assist (VSA) OFF Indicator	<ul style="list-style-type: none"> • Comes on for a few seconds when you turn the ignition switch to ON *1, then goes off. • Comes on when you deactivate VSA. 	<ul style="list-style-type: none"> ➤ VSA OFF Button P. 441 	—





*1: Models with the keyless access system have an **ENGINE START/STOP** button instead of an ignition switch.

Indicator	Name	On/Blinking	Explanation	Message
	High Temperature Indicator (Red)	<ul style="list-style-type: none"> Comes on for a few seconds when you turn the ignition switch to ON *1, then goes off. Blinks when the engine coolant temperature goes up, and stays on if the temperature continues to rise. 	<ul style="list-style-type: none"> Goes off, then comes on blue when the engine coolant temperature is low. 	—
			<ul style="list-style-type: none"> Blinks while driving - Drive slowly to prevent overheating. 	 <p>(White)</p>
			<ul style="list-style-type: none"> Stays on while driving - Immediately stop in a safe place and allow the engine to cool.  Overheating P. 558 	 <p>(Amber)</p>
	Low Temperature Indicator (Blue)	<ul style="list-style-type: none"> Comes on when the engine coolant temperature is low. 	<ul style="list-style-type: none"> If the indicator stays on after the engine has reached normal operating temperature, there may be a problem with the temperature sensors. Have your vehicle inspected by a dealer. 	—







*1: Models with the keyless access system have an **ENGINE START/STOP** button instead of an ignition switch.

Indicator	Name	On/Blinking	Explanation	Message
	Door and Tailgate Open Indicator	<ul style="list-style-type: none"> • Comes on for a few seconds when you turn the ignition switch to ON *1, then goes off. • Comes on if any door or the tailgate is not completely closed. • The beeper sounds and the indicator comes on if any door or the tailgate is opened while driving. 	<ul style="list-style-type: none"> • Goes off when all doors and the tailgate are closed. 	





*1: Models with the keyless access system have an **ENGINE START/STOP** button instead of an ignition switch.





Indicator	Name	On/Blinking	Explanation	Message
	Low Tyre Pressure/Deflation Warning System Indicator	<ul style="list-style-type: none"> • Comes on for a few seconds when you turn the ignition switch to ON *1, then goes off. • May come on briefly if the ignition switch is turned to ON *1 and the vehicle is not moved within 45 seconds, to indicate the calibration process is not yet complete. • Comes on and stays on when: <ul style="list-style-type: none"> - One or more tyres' pressures are determined to be significantly low. - The system has not been calibrated. 	<ul style="list-style-type: none"> • Comes on while driving - Stop in a safe place, check tyre pressures, and inflate the tyre(s) if necessary. • Stays on after the tyres are inflated to the recommended pressures - The system needs to be calibrated. <ul style="list-style-type: none"> ▣ Deflation Warning System Calibration P. 443 	
		<ul style="list-style-type: none"> • Blinks for about one minute, and then stays on if there is a problem with the deflation warning system, or when a compact spare tyre* is temporarily installed. 	<ul style="list-style-type: none"> • Blinks and remains on - Have your vehicle checked by a dealer. If the vehicle is fitted with a compact spare, get your regular tyre repaired or replaced and put back on your vehicle as soon as you can. 	

*1: Models with the keyless access system have an **ENGINE START/STOP** button instead of an ignition switch.





Indicator	Name	On/Blinking	Explanation	Message
	Electric Power Steering (EPS) System Indicator	<ul style="list-style-type: none"> • Comes on when you turn the ignition switch to ON *1, and goes off when the engine starts. • Comes on if there is a problem with the EPS system. 	<ul style="list-style-type: none"> • Stays on constantly or does not come on at all - Have your vehicle checked by a dealer. <ul style="list-style-type: none"> ➤ If the Electric Power Steering (EPS) System Indicator Comes On P. 562 	
	System Message Indicator	<ul style="list-style-type: none"> • Comes on for a few seconds when you turn the ignition switch to ON *1, then goes off. • Comes on along with a beep when a problem is detected. A system message on the multi-information display appears at the same time. 	<ul style="list-style-type: none"> • While the indicator is on, press the /▼ (information) button to see the message again. • Refer to the Indicators information in this chapter when a system message appears on the multi-information display. Take appropriate action for the message. • The multi-information display does not return to the normal screen unless the warning is cancelled, or the button is pressed. 	

*1: Models with the keyless access system have an **ENGINE START/STOP** button instead of an ignition switch.

Indicator	Name	On/Blinking	Explanation	Message
	Turn Signal and Hazard Warning Indicators	<ul style="list-style-type: none"> • Blinks when you operate the turn signal lever. • Blink along with all turn signals if you press the hazard warning button. • Blinks along with all turn signals when you depress the brake pedal during high speed driving. 	<ul style="list-style-type: none"> • Does not blink or blinks rapidly - A turn signal light bulb has blown. Change the bulb immediately. <ul style="list-style-type: none"> ➤ Replacing Light Bulbs P. 496, 498 ➤ Emergency Stop Signal P. 455 	—
	High Beam Indicator	<ul style="list-style-type: none"> • Comes on when the high beam headlights are on. 	—	—
	Lights On Indicator	<ul style="list-style-type: none"> • Comes on whenever the light switch is on, or in AUTO when the exterior lights are on. 	<ul style="list-style-type: none"> • If you remove the key from the ignition switch*, or set the power mode* to VEHICLE OFF (LOCK) while the exterior lights are on, a chime sounds when the driver's door is opened. 	—
	Front Fog Light Indicator*	<ul style="list-style-type: none"> • Comes on when the front fog lights are on. 	—	—
	Rear Fog Light Indicator	<ul style="list-style-type: none"> • Comes on when the rear fog light is on. 	—	—

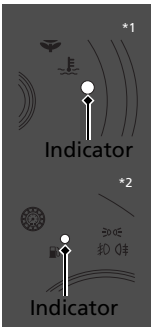













Indicator	Name	On/Blinking	Explanation	Message
	Immobilizer System Indicator	<ul style="list-style-type: none"> • Comes on briefly when you turn the ignition switch to ON *1, then goes off. • Comes on if the immobilizer system cannot recognize the key information. 	<ul style="list-style-type: none"> • Blinks - Models without keyless access system You cannot start the engine. Turn the ignition switch to LOCK , pull the key out, and then insert the key and turn it to ON  again. Models with keyless access system You cannot start the engine. Set the power mode to VEHICLE OFF (LOCK), then select the ON mode again. • Repeatedly blinks - The system may be malfunctioning. Have your vehicle checked by a dealer. • Do not attempt to alter this system or add other devices to it. Electrical problems can occur. 	—

*1: Models with the keyless access system have an **ENGINE START/STOP** button instead of an ignition switch.

Indicator	Name	On/Blinking	Explanation	Message
 <p>*1 Indicator *2 Indicator</p>	<p>Security System Alarm Indicator*</p>	<ul style="list-style-type: none"> Blinks when the security system alarm has been set. 	<p> Security System Alarm * P. 156</p>	
	<p>Keyless Access System Indicator*</p>	<ul style="list-style-type: none"> Comes on for a few seconds when you set the power mode to ON, then goes off. Comes on as soon as a problem is detected in the keyless access system or keyless starting system. 	<ul style="list-style-type: none"> Stays on constantly or does not come on at all - Have your vehicle checked by a dealer. 	

*1 : Left-hand drive type











*2 : Right-hand drive type

Indicator	Name	On/Blinking	Explanation	Message
	Shift Up Indicator	<ul style="list-style-type: none"> Comes on briefly when you turn the ignition switch to ON *1, then goes off. Comes on when shifting up is recommended. 	<ul style="list-style-type: none">  Shift Up Indicator P. 400  Shift Up/Down Indicators P. 402 	—
	Shift Down Indicator	<ul style="list-style-type: none"> Comes on briefly when you turn the ignition switch to ON *1, then goes off. Comes on when shifting down is recommended. 	<ul style="list-style-type: none">  Shift Up/Down Indicators P. 402 	—
	Cruise Main Indicator	<ul style="list-style-type: none"> Comes on when the cruise control is ready to use. 	<ul style="list-style-type: none">  Cruise Control P. 414 	—
	Adjustable Speed Limiter Indicator	<ul style="list-style-type: none"> Comes on when the adjustable speed limiter is ready to use. 	<ul style="list-style-type: none">  Adjustable Speed Limiter P. 417 	—
	Cruise Control and Adjustable Speed Limiter Set Speed Indicator	<ul style="list-style-type: none"> Comes on when you have set a speed for cruise control or for adjustable speed limiter. 	<ul style="list-style-type: none">  Cruise Control P. 414  Adjustable Speed Limiter P. 417 	—





*1: Models with the keyless access system have an **ENGINE START/STOP** button instead of an ignition switch.

*2: Continuously variable transmission models









*3: Manual transmission models

Indicator	Name	On/Blinking	Explanation	Message
	High Beam Support System Indicator*	<ul style="list-style-type: none"> Comes on for a few seconds when you turn the ignition switch to ON *1, then goes off. Comes on when all the operating conditions of the high beam support system are met. 	<p> High Beam Support System* P. 172</p>	
	Auto Idle Stop Indicator (Green)	<ul style="list-style-type: none"> Comes on when Auto Idle Stop is in operation. The engine automatically shuts off. 	<p> Auto Idle Stop P. 404, 409</p>	
		<p>Models with climate control system</p> <ul style="list-style-type: none"> Blinks when the ambient conditions may cause the windows to fog up. Blinks when the ambient conditions may become different from the climate control settings you have selected.  (windscreen demister) is touched. <p>Models with heating and cooling system</p> <ul style="list-style-type: none"> Blinks when the fan is turned on and the mode control dial is turned to . 	<p>Manual transmission models</p> <ul style="list-style-type: none"> Depress the clutch pedal. The engine automatically restarts. <p> Auto Idle Stop P. 409</p>	 (White)







*1 : Models with the keyless access system have an **ENGINE START/STOP** button instead of an ignition switch.

Indicator	Name	On/Blinking	Explanation	Message
	Auto Idle Stop System Indicator (Amber)	<ul style="list-style-type: none"> • Comes on for a few seconds when you turn the ignition switch to ON *1, then goes off. • Blinks if there is a problem with the Auto Idle Stop system. 	<ul style="list-style-type: none"> • Blinks - Have your vehicle checked by a dealer. 	
		<ul style="list-style-type: none"> • Comes on when the Auto Idle Stop system has been turned off by the Auto Idle Stop system OFF button. 	 Auto Idle Stop System ON/OFF P. 405, 410	

*1: Models with the keyless access system have an **ENGINE START/STOP** button instead of an ignition switch.





Indicator	Name	On/Blinking	Explanation	Message
	Forward Collision Warning Indicator*	<ul style="list-style-type: none"> • Comes on for a few seconds when you turn the ignition switch to ON *1, then goes off. • Comes on when you have customized forward collision warning system to turn off. • Comes on if there is a problem with the system. 	<ul style="list-style-type: none"> • Stays on constantly without the system off - Have your vehicle checked by a dealer. 	 (White)  (Amber)
		<ul style="list-style-type: none"> • Comes on when the system shuts itself off. 	<ul style="list-style-type: none"> • Stays on - The temperature inside the camera is too high. The system activates when the temperature inside the system cools down.  Automatic shutoff P. 430 	
			<ul style="list-style-type: none"> • Stays on - The area around the camera is blocked by dirt, mud, etc. Stop your vehicle in a safe place, and wipe it off with a soft cloth. • Have your vehicle checked by a dealer if the indicator and message come back on after you cleaned the area around the camera.  Automatic shutoff P. 430 	

*1: Models with the keyless access system have an **ENGINE START/STOP** button instead of an ignition switch.



Indicator	Name	On/Blinking	Explanation	Message
	Lane Departure Warning Indicator*	<ul style="list-style-type: none"> • Comes on for a few seconds when you turn the ignition switch to ON *¹, then goes off. • Comes on if there is a problem with the lane departure warning system. 	<ul style="list-style-type: none"> • Stays on constantly - Have your vehicle checked by a dealer. 	
		<ul style="list-style-type: none"> • Comes on when the system shuts itself off. 	<ul style="list-style-type: none"> • Stays on - The temperature inside the camera is too high. Use the heating and cooling system*/ climate control system* to cool down the camera. The system activates when the temperature inside the camera cools down.  Lane Departure Warning Camera P. 433 	
			<ul style="list-style-type: none"> • Stays on - The area around the camera is blocked by dirt, mud, etc. Stop your vehicle in a safe place, and wipe it off with a soft cloth. • Have your vehicle checked by a dealer if the indicator and message come back on after you cleaned the area around the camera.  Lane Departure Warning Camera P. 433 	

*1: Models with the keyless access system have an **ENGINE START/STOP** button instead of an ignition switch.

* Not available on all models

Indicator	Name	On/Blinking	Explanation	Message
CTBA	City-Brake Active System (CTBA) Indicator	<ul style="list-style-type: none"> Comes on for a few seconds when you turn the ignition switch to ON *1, then goes off. 	—	—
		<ul style="list-style-type: none"> Goes off when you have customized the City-Brake Active system to turn on. Comes on when you have customized the City-Brake Active system to turn off. 	<ul style="list-style-type: none">  City-Brake Active system P. 450  Customized Features P. 129 	—
		<ul style="list-style-type: none"> Comes on when the area around the laser sensor, which is located in the upper part of the windscreen, is covered with obstacles, such as dirt, ice and frost. May come on when driving in bad weather (rain, fog, snow). 	<ul style="list-style-type: none"> Remove the dirt or any obstacles using the washer and wipers. Stop your vehicle in a safe place and wipe away dirt or any obstacles covering the area around the laser sensor on the windscreen.  City-Brake Active system P. 450 The system resumes when obstacles are removed. 	
		<ul style="list-style-type: none"> Comes on when snow is accumulated on the bonnet. 	<ul style="list-style-type: none"> Stop your vehicle in a safe place and remove snow from the bonnet. 	







*1: Models with the keyless access system have an **ENGINE START/STOP** button instead of an ignition switch.

Indicator	Name	On/Blinking	Explanation	Message
<p>CTBA</p>	<p>City-Brake Active System (CTBA) Indicator</p>	<ul style="list-style-type: none"> • May come on when the temperatures of the area around the laser sensor are high. 	<ul style="list-style-type: none"> • Use the heating and cooling system*/ climate control system* to cool down the area around the laser sensor. • The system resumes when the temperatures of the area around the laser sensor go down. 	
		<ul style="list-style-type: none"> • Comes on along with the brake system indicator (amber) if there is a problem with the system. 	<ul style="list-style-type: none"> • The system does not activate. Have your vehicle checked by a dealer. 	



* Not available on all models

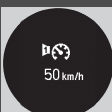

Multi-Information Display Warning and Information Messages



The following messages appear only on the multi-information display. Press the  (information) button to see the message again with the system message indicator on.



Message	Condition	Explanation
	<ul style="list-style-type: none"> Appears while you are customizing the settings and the shift lever is moved out of P. 	<p> Customized Features P. 129</p>
	<ul style="list-style-type: none"> Appears once if the outside temperature is below 3°C while the ignition switch is in ON II*1. 	<ul style="list-style-type: none"> There is a possibility that the road surface is icy and slippery.
	<ul style="list-style-type: none"> Appears when any of the rear seat belts are latched or unlatched, or either rear door is opened and closed. 	<p> Seat Belt Reminder P. 40</p>
	<ul style="list-style-type: none"> Appears when the vehicle speed reaches the set speed. You can set two different speeds for the alarm. 	<p> List of customizable options P. 132</p>

*1 : Models with the keyless access system have an **ENGINE START/STOP** button instead of an ignition switch.



Message	Condition	Explanation
	<ul style="list-style-type: none"> • Appears when the engine oil level is low while the engine is running. 	<ul style="list-style-type: none"> • Appears while driving - Immediately stop in a safe place. <input checked="" type="checkbox"/> If the Low Oil Level Symbol Appears P. 564
	<ul style="list-style-type: none"> • Appears when the engine is running, there is a system problem in the engine oil level sensor. 	<ul style="list-style-type: none"> • Have your vehicle checked by a dealer.
	<ul style="list-style-type: none"> • Appears if there is a problem with the automatic lighting control system. 	<ul style="list-style-type: none"> • Appears while driving - Manually turn the lights on, and have your vehicle checked by a dealer.

Message	Condition	Explanation
	<ul style="list-style-type: none"> Flashes when the City-Brake Active system senses a likely collision with a vehicle in front of you. The beeper sounds. 	<ul style="list-style-type: none"> Depress the brake pedal, and keep an appropriate distance from the vehicle ahead. The alert will disappear. The system automatically applies the brake if a possible collision becomes likely unavoidable. <ul style="list-style-type: none"> ➤ City-Brake Active system P. 450
	<ul style="list-style-type: none"> Changes the display when your vehicle is stopped by the City-Brake Active system. The beeper stops. 	

Message	Condition	Explanation
	<ul style="list-style-type: none"> • Appears when Auto Idle Stop does not activate for some reason. • Appears when the engine restarts automatically. 	<p>➤ Auto Idle Stop Activates When: P. 406, 411</p>
	<ul style="list-style-type: none"> • Appears when Auto Idle Stop does not activate because the engine coolant temperature is low or high. 	<p>➤ Auto Idle Stop does not activate when: P. 406, 411</p>
	<ul style="list-style-type: none"> • Appears when Auto Idle Stop does not activate because the climate control system is in use, and the difference between the set temperature and actual interior temperature becomes significant. <p>Continuously variable transmission models Models with climate control system</p> <ul style="list-style-type: none"> • Appears when Auto Idle Stop does not activate because the climate control system is in use, and the difference between the set temperature and actual interior temperature becomes significant. 	<p>➤ Auto Idle Stop P. 404, 409</p> <ul style="list-style-type: none"> • The engine restarts automatically in a few seconds.







Message	Condition	Explanation
	<ul style="list-style-type: none"> • Appears when Auto Idle Stop does not activate because the battery charge level is low. • Appears when the battery is low performance. <ul style="list-style-type: none"> • Appears when the system is under the following conditions while Auto Idle Stop activates: <ul style="list-style-type: none"> - The battery charge level is low. 	<ul style="list-style-type: none"> • Comes on even though the battery is fully charged <ul style="list-style-type: none"> - The system may not read the battery amount correctly. Drive for a few minutes. • Comes on after charging the battery or jump starting - Disconnect the negative ⊖ cable once and reconnect it again to the battery. Drive for a few minutes. <ul style="list-style-type: none"> ➤ Auto Idle Stop P. 404, 409 • The engine restarts automatically in a few seconds.
	<ul style="list-style-type: none"> • Appears when the bonnet is opened. 	<ul style="list-style-type: none"> • Close the bonnet.

Continuously variable transmission models

Message	Condition	Explanation
	<ul style="list-style-type: none"> Appears if you press the ENGINE START/STOP button to turn the engine off without the shift lever in P. 	<ul style="list-style-type: none"> Press the ENGINE START/STOP button twice with your foot off the brake pedal, after moving the shift lever to P.
	<ul style="list-style-type: none"> Appears when the engine stops without the shift lever in P, and does not restart automatically. Appears if you open the bonnet with Auto Idle Stop activated. 	<ul style="list-style-type: none"> If you want to turn the ignition switch to ON II*1, move the shift lever to P. If you want to start the engine, follow the normal procedure. <p>▶ Starting the Engine P. 386, 389</p>
	<ul style="list-style-type: none"> Appears when Auto Idle Stop does not activate because the pressure to the brake pedal is not enough. 	<ul style="list-style-type: none"> Depress the brake pedal firmly.

*1: Models with the keyless access system have an **ENGINE START/STOP** button instead of an ignition switch.

Manual transmission models



Message	Condition	Explanation
	<ul style="list-style-type: none"> Appears when the shift lever is in any position except N. 	<ul style="list-style-type: none"> Shift to N.  Auto Idle Stop Activates When: P. 411
	<ul style="list-style-type: none"> Appears in white when you turn the ignition switch to START III*1 before fully depressing the clutch pedal. <p>Models with climate control system</p> <ul style="list-style-type: none"> Blinks when the ambient conditions may cause the windows to fog up. Blinks when the ambient conditions may become different from the climate control settings you have selected.  (windscreen demister) is touched. <p>Models with heating and cooling system</p> <ul style="list-style-type: none"> Blinks when the fan is turned on and the mode control dial is turned to . 	<ul style="list-style-type: none"> Depress the clutch pedal. Depress the clutch pedal. The engine automatically restarts.  Auto Idle Stop P. 409
	<ul style="list-style-type: none"> Appears in amber when the following conditions are kept while Auto Idle Stop is in operation: <ul style="list-style-type: none"> - You are not wearing a seat belt. - The shift lever is in any position except N. 	<ul style="list-style-type: none"> Depress the clutch pedal. Wear the seat belt immediately, and continue to keep the shift lever in N next time Auto Idle Stop activates.

*1: Models with the keyless access system have an **ENGINE START/STOP** button instead of an ignition switch.





Models with high beam support system

Message	Condition	Explanation
	<ul style="list-style-type: none"> • Appears when there is a problem with the high beam support system. • Appears when the high beam support system camera lens gets dirty. 	<ul style="list-style-type: none"> • Manually operate the headlight switch. • If you are driving with the high beam headlights when this happens, the headlights are changed to low beams. • Stop in a safe place and clean the camera lens with a soft cloth. • If the message does not disappear after cleaning the lens, have your vehicle checked by a dealer.

Models with service reminder system

Message	Condition	Explanation
	<ul style="list-style-type: none"> • Appears when any of the service items is required in less than 30 days. The remaining days are estimated based on your driving conditions. 	<ul style="list-style-type: none"> • The remaining days will be counted down per day. ➤ Service Reminder System * P. 473
	<ul style="list-style-type: none"> • Appears when any of the service items is required in less than 10 days. The remaining days are estimated based on your driving conditions. 	<ul style="list-style-type: none"> • Have the indicated service performed as soon as possible. ➤ Service Reminder System * P. 473
	<ul style="list-style-type: none"> • Appears when the indicated maintenance service is still not done after the remaining days reach 0. 	<ul style="list-style-type: none"> • Your vehicle has passed the service required point. Immediately have the service performed and make sure to reset the service reminder. ➤ Service Reminder System * P. 473





Models without keyless access system

Message	Condition	Explanation
	<ul style="list-style-type: none"> Appears when the ignition key is turned to ACCESSORY [I] from ON [II]. (The driver's door is closed.) 	—
	<ul style="list-style-type: none"> Appears when you open the driver's door while the ignition key is in ACCESSORY [I]. 	<ul style="list-style-type: none"> Turn the ignition switch to LOCK [0], then remove the key.
	<ul style="list-style-type: none"> Appears when you open the driver's door while the ignition key is in LOCK [0]. 	<ul style="list-style-type: none"> Remove the key from the ignition switch.
<div style="display: flex; flex-direction: column;"> <div style="display: flex; align-items: center;">  *1 </div> <div style="display: flex; align-items: center;">  *2 </div> </div>	<ul style="list-style-type: none"> Appears in white when you turn the ignition switch to START [III] before fully depressing the clutch pedal. Appears in amber when the engine does not restart automatically due to the following reasons: <ul style="list-style-type: none"> - The bonnet is open. - There is a problem in the system that disables Auto Idle Stop. 	<ul style="list-style-type: none"> Turn the ignition switch after fully depressing the clutch pedal. Follow the normal procedure to start the engine. <ul style="list-style-type: none"> ▶ Starting the Engine P. 386



*1: Manual transmission models



*2: Continuously variable transmission models

Models with keyless access system

Message	Condition	Explanation
 *1	<ul style="list-style-type: none"> • Appears in white after you unlock and open the driver's door. • Appears in white when you set the power mode to ACCESSORY or ON. 	<p>➤ Starting the Engine P. 389</p>
 *2	<ul style="list-style-type: none"> • Appears in amber when the engine does not restart automatically due to the following reasons: <ul style="list-style-type: none"> - The bonnet is open. - There is a problem in the system that disables Auto Idle Stop. 	<ul style="list-style-type: none"> • Follow the normal procedure to start the engine. <ul style="list-style-type: none"> ➤ Starting the Engine P. 389
 (White)	<ul style="list-style-type: none"> • Appears when the power mode is in ACCESSORY. 	<p>—</p>
 (Amber)	<ul style="list-style-type: none"> • Appears after the driver's door is opened when the power mode is in ACCESSORY. 	<ul style="list-style-type: none"> • Press the ENGINE START/STOP button twice with your foot off the brake pedal to change the power mode to VEHICLE OFF (LOCK).

*1 : Continuously variable transmission models
 *2 : Manual transmission models

Message	Condition	Explanation
	<ul style="list-style-type: none"> • Appears when you close the door with the power mode in ON without the keyless remote inside the vehicle. 	<ul style="list-style-type: none"> • Disappears when you bring the keyless remote back inside the vehicle and close the door. <ul style="list-style-type: none"> ➤ Keyless Remote Reminder P. 164
	<ul style="list-style-type: none"> • Appears when the keyless remote battery becomes weak. 	<ul style="list-style-type: none"> • Replace the battery as soon as possible. <ul style="list-style-type: none"> ➤ Replacing the Button Battery P. 520
	<ul style="list-style-type: none"> • Appears if the keyless remote battery is too weak to start the engine or the key is not within operating range to start the engine. A beeper sounds six times. 	<ul style="list-style-type: none"> ➤ If the Keyless Remote Battery is Weak P. 552

Message	Condition	Explanation
	<ul style="list-style-type: none"> Appears if the starting system has a problem. 	<ul style="list-style-type: none"> As a temporary measure, press and hold the ENGINE START/STOP button for 15 seconds while pressing the brake pedal and manually start the engine. Have your vehicle checked by a dealer.
	<p>Continuously variable transmission models</p> <ul style="list-style-type: none"> Appears if you press the ENGINE START/STOP button to turn the engine off without the shift lever in P. 	<ul style="list-style-type: none"> Press the ENGINE START/STOP button twice after moving the shift lever to P.
	<ul style="list-style-type: none"> Appears when the steering wheel is locked. 	<ul style="list-style-type: none"> Move the steering wheel left and right while pressing the ENGINE START/STOP button.

Models with forward collision warning



Message	Condition	Explanation
	<ul style="list-style-type: none"> Flashes when the system senses a likely collision with a vehicle in front of you. The beeper sounds. 	<ul style="list-style-type: none"> Take the appropriate means to prevent a collision (apply the brakes, change lanes, etc.) ➤ Forward Collision Warning* P. 428

Models with lane departure warning

Message	Condition	Explanation
	<ul style="list-style-type: none"> Appears when your vehicle is too close to the traffic lane lines. The beeper sounds. 	<ul style="list-style-type: none"> Take appropriate action to keep your vehicle within the lane lines. ➤ Lane Departure Warning* P. 432

* Not available on all models

Models with parking sensor system

Message	Condition	Explanation
	<ul style="list-style-type: none"> • Appears if there is a problem with the parking sensor system. 	<ul style="list-style-type: none"> • Check if the area around the sensor(s) is covered with mud, ice, snow, etc. If the indicator(s) stays on even after you clean the area, have the system checked by a dealer.
	<ul style="list-style-type: none"> • If there is a problem with any of the sensors, the appropriate sensor indicator(s) comes on. 	

Gauges

Gauges include the speedometer, tachometer, and related indicators. They are displayed when the ignition switch is in ON *1.

Speedometer

Right-hand drive type

Displays your driving speed in km/h and mph.

Left-hand drive type

Displays your driving speed in km/h.

Tachometer

Shows the number of engine revolutions per minute.

Ambient Meter

Changes colour to reflect your driving style.

Green: Fuel efficient driving

Blue green: Moderate acceleration/deceleration

Blue: Aggressive acceleration/deceleration

The ambient meter colour changes in accordance with your brake or accelerator pedal operation.

*1: Models with the keyless access system have an **ENGINE START/STOP** button instead of an ignition switch.

Multi-Information Display

The multi-information display shows the odometer, trip meter, outside temperature, fuel gauge, and other gauges. It also displays important messages such as warnings and other helpful information.

Switching the Display

Main displays

Press the (information) button to change the display.

Switching the Display

Right-hand drive type

Switch between km/h and mph by using the customized features on the multi-information display.

Customized Features P. 129

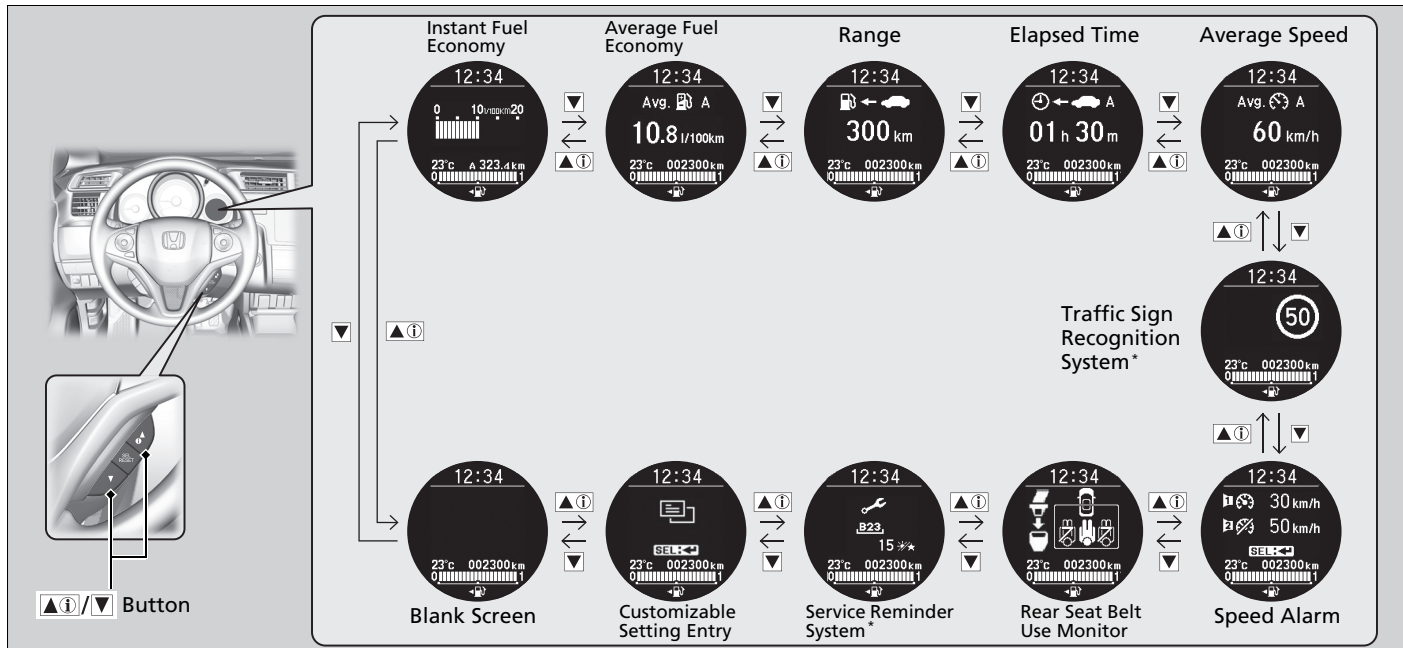

■ Lower displays

Press the **SEL/RESET** button to change the display.

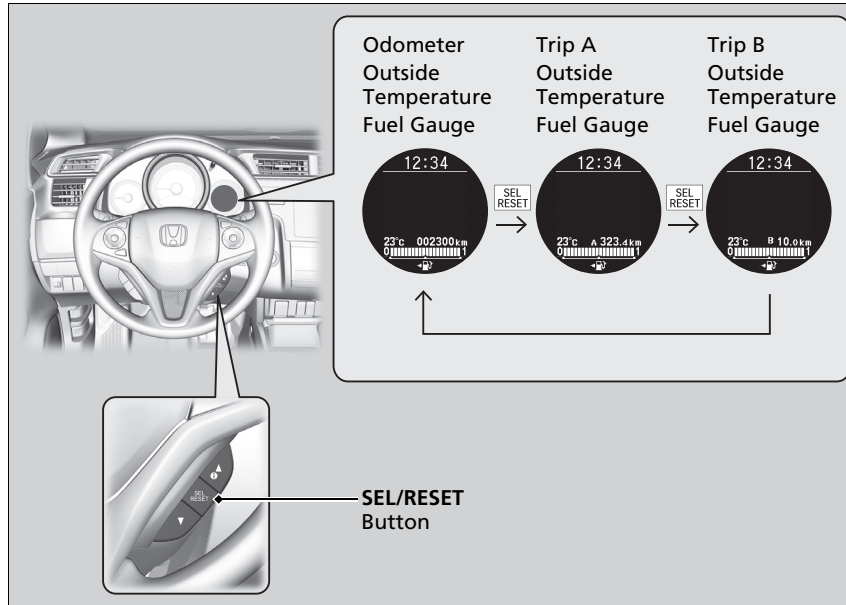

▶ Switching the Display

▶ Adjusting the Clock P. 138

Models with display audio system

Some of the items on the information display also appear on the audio/information screen. They also change along with the information display changes while the fuel consumption is shown.

■ Odometer

Shows the total number of kilometres or miles* that your vehicle has accumulated.

■ Trip Meter

Shows the total number of kilometres or miles* driven since the last reset. Trip A and B can be used to measure two separate trips.

■ Resetting a trip meter

To reset a trip meter, display it, then press and hold the **SEL/RESET** button. The trip meter is reset to **0.0**.

■ Average Fuel Economy

Shows the estimated average fuel economy of each trip meter in l/100 km or mpg*. The display is updated at set intervals. When a trip meter is reset, the average fuel economy is also reset.

■ Range

Shows the estimated distance you can travel on the remaining fuel. This distance is estimated from the fuel economy of your previous trips.

■ Elapsed Time

Shows the time elapsed since trip A or trip B was reset.

▶▶ Trip Meter

Switch between trip A and B by pressing the **SEL/RESET** button.

▶▶ Average Fuel Economy

You can change when to reset the average fuel economy.

▶▶ **Customized Features** P. 129

▶▶ Elapsed Time

You can change when to reset the elapsed time.

▶▶ **Customized Features** P. 129

■ Average Speed

Shows the average speed in km/h or mph* since trip A or trip B was reset.

■ Instant Fuel Economy

Shows the instant fuel economy as a bar graph in l/100 km or mpg*.

■ Outside Temperature

Shows the outside temperature in Celsius.

If the outside temperature has been below 3°C at the time you turn the ignition switch to ON *, the outside temperature indicator blinks for 10 seconds.

■ Adjusting the outside temperature display

Adjust the temperature reading up to ±3°C if the temperature reading seems incorrect.

■ Rear Seat Belt Use Monitor

Shows the rear seat belt use.

 **Seat Belt Reminder** P. 40

⊗ Average Speed

You can change when to reset the average speed.

 **Customized Features** P. 129

⊗ Outside Temperature

The temperature sensor is in the front bumper. Road heat and exhaust from another vehicle can affect the temperature reading when your vehicle speed is less than 30 km/h (19 mph).

It may take several minutes for the display to be updated after the temperature reading has stabilized.

Use the multi-information display's customized features to correct the temperature.

 **Customized Features** P. 129

*1: Models with the keyless access system have an **ENGINE START/STOP** button instead of an ignition switch.

* Not available on all models

■ Fuel Gauge

Displays the amount of fuel left in the fuel tank.

■ Traffic Sign Recognition System *

Shows the traffic sign recognition system.

📖 **Traffic Sign Recognition System** * P. 436

■ Service Reminder System *

Shows the service reminder system.

📖 **Service Reminder System** * P. 473

📖 Fuel Gauge

NOTICE

You should refuel when the reading approaches $\boxed{0}$. Running out of fuel can cause the engine to misfire, damaging the catalytic converter.

The actual amount of remaining fuel may differ from the fuel gauge reading.

■ Speed Alarm Setting

Sets the speed alarm on and changes the speed alarm setting.

■ To set the speed alarm



1. Press the /▼ button until the speed alarm setting screen appears on the display, then press the **SEL/RESET** button.

2. Press the /▼ button and select (speed alarm 1) or (speed alarm 2), then press the **SEL/RESET** button.
 - ▶ (off) switches to (on), then the display returns to the normal screen.
 - ▶ If the speed alarm is (on), it switches to (off).

⌘ Speed Alarm Setting

The default settings for (speed alarm 1) and (speed alarm 2) are (off).

You can also return to the normal screen by selecting (exit).

■ To change the speed setting

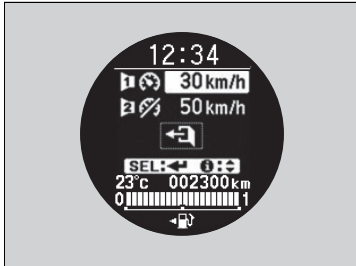

1. Press the button until the speed alarm setting menu appears on the display, then press the **SEL/RESET** button.
2. Press the button and select the speed alarm 1 speed setting or speed alarm 2 speed setting, then press the **SEL/RESET** button.
3. Press the button and select the speed, then press the **SEL/RESET** button.
 - ▶ The speed setting is set, then the display returns to the normal screen.
 - ▶ You can set the speed setting over 5 km/h (mph) with 1 km/h (mph) steps.



▶▶ Speed Alarm Setting

You cannot change the speed setting while driving.

■ Customized Features

Use the multi-information display to customize certain features.

■ How to customize

Select the  (Customize Settings) screen by pressing the  button while the ignition switch is in ON *1, the vehicle is at a complete stop, and the shift lever is in **P** (continuously variable transmission), and the parking brake is set (manual transmission). Press the **SEL/RESET** button to enter the customizing mode.

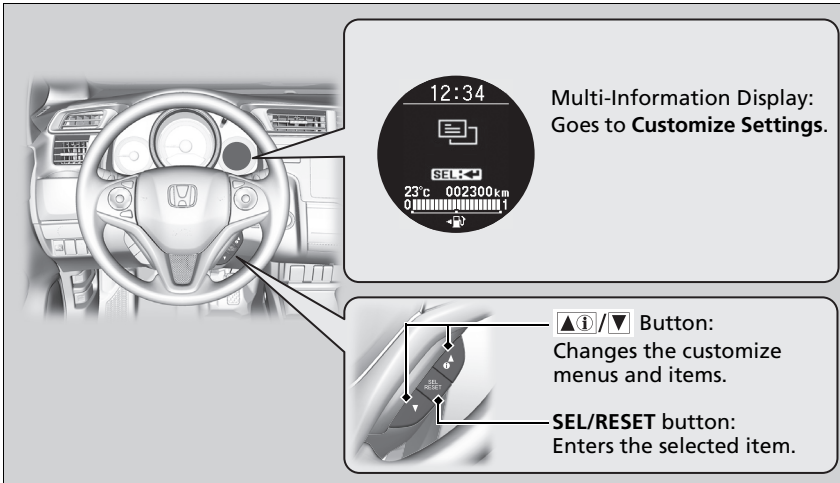

*1: Models with the keyless access system have an **ENGINE START/STOP** button instead of an ignition switch.

Customized Features

To customize other features, press the  button.

 **List of customizable options** P. 132

 **Example of customization settings** P. 135

When you customize settings:

Continuously variable transmission models

Shift to **P**.

Manual transmission models

Set the parking brake.

■ Customization flow

Press the ▲i/▼ button.

Instrument Panel

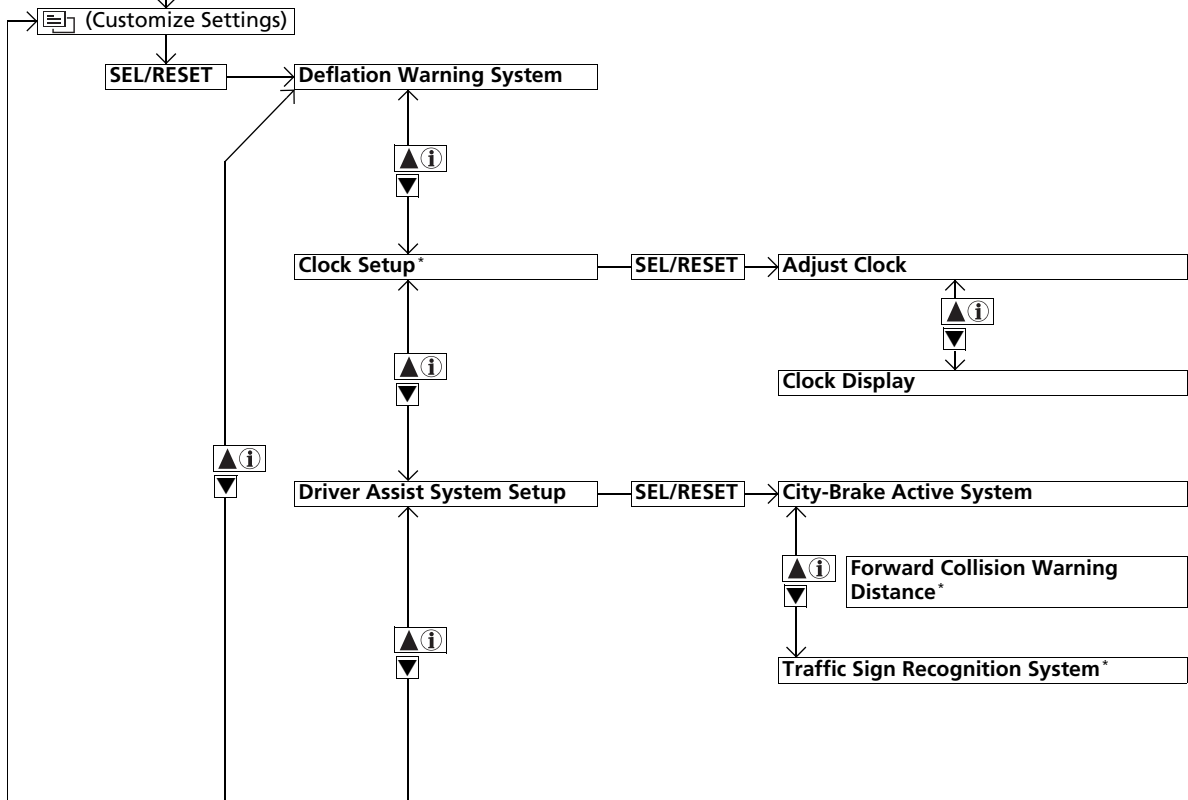

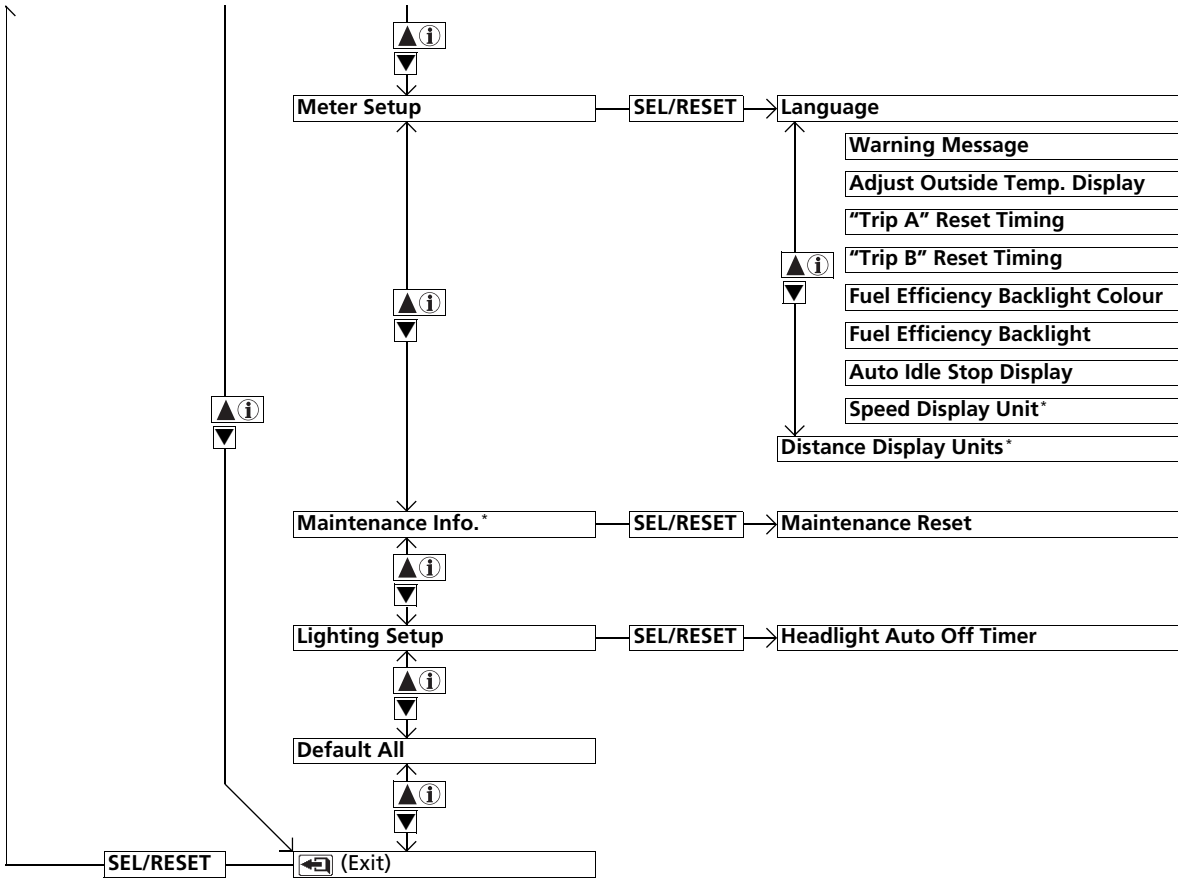

* Not available on all models

■ List of customizable options

Setup Group	Customizable Features	Description	Selectable Settings
Deflation Warning System		Initialises the deflation warning system	Cancel/Initialise
Clock Setup*	Adjust Clock	Adjusts the time.	
	Clock Display	Sets time display 12 hour, 24 hour, or OFF.	12h^{*1}/24h/OFF
Driver Assist System Setup	City-Brake Active System	Turns the City-Brake Active system feature on and off.	On^{*1}/Off
	Forward Collision Warning Distance*	Changes at which distance forward collision warning alerts, or turns the system on and off.	Far/Normal^{*1}/Near/Off
	Traffic Sign Recognition System*	Selects whether the traffic sign small icons come on.	Small Icon ON^{*1}/Small Icon OFF

*1: Default Setting

Setup Group	Customizable Features	Description	Selectable Settings
Meter Setup	Language	Changes the displayed language.	English*¹/German/Italian/ French/Spanish/Polish/ Portuguese/Dutch/Danish/ Swedish/Norwegian/Finnish/ Russian
	Warning Message	Switches warning message to be displayed or not.	On/Off*¹
	Adjust Outside Temp. Display	Adjusts the temperature reading by a few degrees.	-3°C ~ ±0°C*¹ ~ +3°C
	“Trip A” Reset Timing	Changes the setting of how to reset trip meter A, average fuel economy A, average speed A, and elapsed time A.	When Refueled/When Ignition Is Turned Off/ Manual Reset*¹
	“Trip B” Reset Timing	Changes the setting of how to reset trip meter B, average fuel economy B, average speed B, and elapsed time B.	When Refueled/When Ignition Is Turned Off/ Manual Reset*¹
	Fuel Efficiency Backlight Colour	Changes the ambient meter colour.	Random/Blue/Violet/Pink/ Red/Amber/Yellow/White*¹
	Fuel Efficiency Backlight	Turns the ambient meter feature on and off.	On*¹/Off

*1: Default Setting

Setup Group	Customizable Features	Description	Selectable Settings
Meter Setup	Auto Idle Stop Display	Selects whether the Auto Idle Stop display comes on or not.	On*¹/Off
	Speed Display Unit*	Changes the displayed measurement of the vehicle speed on the multi-information display.	km/h/mph*¹
	Distance Display Units*	Changes the displayed measurement on the multi-information display.	km/miles*¹
Maintenance Info.*	Maintenance Reset	Reset the service reminder item(s).	Cancel/All Due Items/ Item A Only/Item B Only/ Item 0 Only/Item 1 Only/ Item 2 Only/Item 3 Only/ Item 4 Only/Item 5 Only/ Item 6 Only/Item 7 Only/ Item 8 Only/Item 9 Only
Lighting Setup	Headlight Auto Off Timer	Changes the length of time the exterior lights stay on after you close the driver's door.	60sec/30sec/15sec*¹/0sec
Default All	—	Cancels/Resets all the customized settings as default.	Cancel/Ok

*1: Default Setting

■ Example of customization settings

The steps for changing the “Trip A” Reset Timing setting to **When Refueled** are shown below. The default setting for “Trip A” Reset Timing is **Manual Reset**.

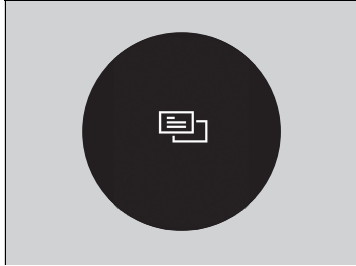

1. Press the /▼ button until (customize settings) appears on the display, then press the **SEL/RESET** button.

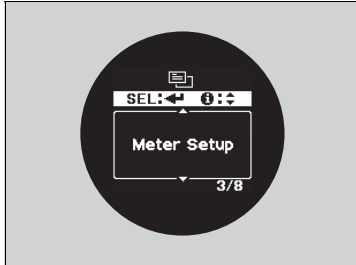

2. Press the /▼ button until **Meter Setup** appears on the display.
3. Press the **SEL/RESET** button.

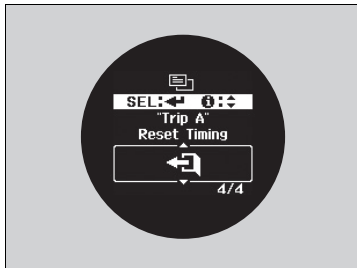
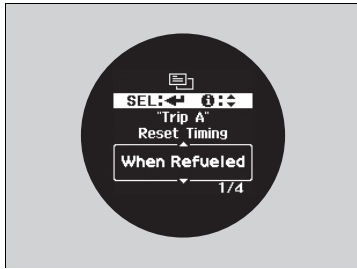

4. Press the /▼ button until **"Trip A" Reset Timing** appears on the display, then press the **SEL/RESET** button.

► The display switches to the customization setup screen, where you can select **When Refueled, When Ignition Is Turned Off, Manual Reset**, or (Exit).

5. Press the /▼ button and select **When Refueled**, then press the **SEL/RESET** button.

► The **When Refueled Setup** screen appears, then the display returns to the customization menu screen.

6. Press the /▼ button until (Exit) appears on the display, then press the **SEL/RESET** button.

7. Repeat Step 6 until you return to the normal screen.

Controls

This chapter explains how to operate the various controls necessary for driving.



Clock	138
Locking and Unlocking the Doors	
Key Types and Functions	140
Low Keyless Remote Signal Strength*	143
Locking/Unlocking the Doors from the Outside	144
Locking/Unlocking the Doors from the Inside	150
Childproof Door Locks	152
Opening and Closing the Tailgate	153
Security System	
Immobilizer System	156
Security System Alarm*	156
Super Locking*	158
Opening and Closing the Windows	159

Operating the Switches Around the Steering Wheel	
Models without keyless access system	
Ignition Switch.....	161
Models with keyless access system	
ENGINE START/STOP Button	162
Ignition Switch and Power Mode Comparison	165
Turn Signals.....	166
Light Switches	167
Fog Lights	169
High Beam Support System*	172
Daytime Running Lights	174
Headlight Adjuster	171
Wipers and Washers	175

Brightness Control.....	178
Rear Demister/Heated Door Mirror*	179
Adjusting the Steering Wheel	180
Adjusting the Mirrors	
Interior Rearview Mirror.....	181
Power Door Mirrors	182
Adjusting the Seats	
Adjusting the Seat Positions.....	183
Rear Seats	190
Interior Lights/Interior Convenience Items	194
Heating and Cooling System*	
Using Vents, Heating and A/C	204
Climate Control System*	
Using Automatic Climate Control	208
Automatic Climate Control Sensors.....	212

* Not available on all models

Adjusting the Clock



You can adjust the time in the clock display with the ignition switch in ON *1.

Adjusting the Time

Models with display audio system

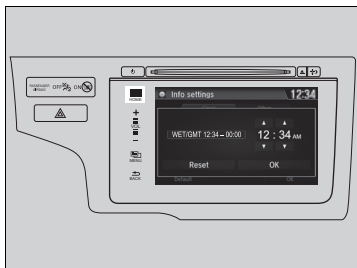
Using the settings menu on the audio/information screen



1. Select the  (HOME) icon, then select **Settings**.
2. Select **Info, Clock**, then **Clock Adjustment**.
3. Adjust the hours and minutes by selecting  / .
4. Select **OK** to set the time.

Adjusting the Clock

Models with display audio system

The clock in the multi-information display is automatically adjusted along with the audio system's clock display.

You can customize the clock display to show the 12 hour clock or 24 hour clock.

 **Customized Features** P. 316

You can turn the clock display on and off.

 **Customized Features** P. 316

The clock is automatically updated when your smartphone is connected to the audio system.

*1 : Models with the keyless access system have an **ENGINE START/STOP** button instead of an ignition switch.

Models with colour audio system

■ Using the MENU/CLOCK button

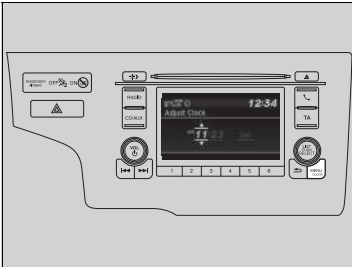

1. Press and hold the **MENU/CLOCK** button.
▶ **Adjust clock** is selected.
2. Rotate to change hour, then press .
3. Rotate to change minute, then press .
4. To enter the selection, rotate and select **Set**, then press .

▶▶ Adjusting the Time

Models with colour audio system

These indications are used to show how to operate the **LIST/SELECT** (Selector) knob.

Rotate to select.

Press to enter.

You can customize the clock display to show the 12 hour clock or 24 hour clock.

▶ **Customized Features** P. 307

You can turn the clock display on and off.

▶ **Customized Features** P. 307

You can also select **Adjust clock** by pressing the **MENU/CLOCK** button.

Rotate to select **Adjust clock**, then press .

The clock in the multi-information display is automatically adjusted along with the audio system's clock display.

■ Setting the Time Zone

Models with display audio system

■ Using the settings menu on the audio/information screen

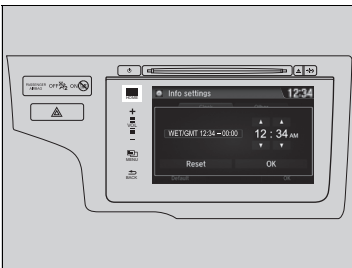

1. Select the (**HOME**) icon, then select **Settings**.
2. Select **Info**, **Clock**, then **Time Zone**.
3. Select your time zone.

Key Types and Functions

This vehicle comes with the following keys:

Keys

Keyless Remote*



Retractable Key*



Use the key to start and stop the engine, and to lock and unlock* all the doors and tailgate. You can also use the remote transmitter or keyless access system* to lock and unlock all the doors and tailgate.

Key Types and Functions

All the keys have an immobilizer system. The immobilizer system helps to protect against vehicle theft.

Immobilizer System P. 156

The keys contain precision electronics.

Adhere to the following advice to prevent damage to the electronics:

- Do not leave the keys in direct sunlight, or in locations with high temperature or high humidity.
- Do not drop the keys or set heavy objects on them.
- Keep the keys away from liquids.
- Do not take the keys apart except for replacing the battery.

If the circuits in the keys are damaged, the engine may not start, and the remote transmitter/keyless access system* may not work.

If the keys do not work properly, have them inspected by a dealer.

■ **Keyless remote***

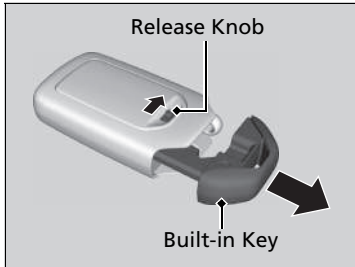

The built-in key can be used to lock/unlock the doors when the keyless remote battery becomes weak and the power door lock/unlock operation is disabled.

To remove the built-in key, pull it out while sliding the release knob. To reinstall the built-in key, push the built-in key into the keyless remote until it clicks.

■ **Retractable keys***

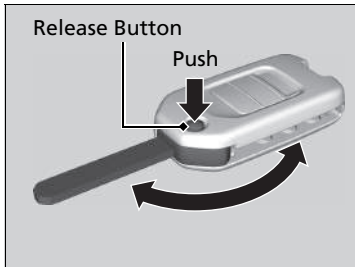

The key folds up inside the remote transmitter.

1. Press the release button to release the key out from the transmitter.
 - ▶ Make sure to fully extend the key.
2. To close the key, press the release button then push the key inside the transmitter until you hear a click.

▣ Retractable keys*

If the key is not fully extended, the immobilizer system may not work properly, and the engine may not start. Avoid contact with the key whenever it extends or retracts.

* Not available on all models

■ Key Number Tag

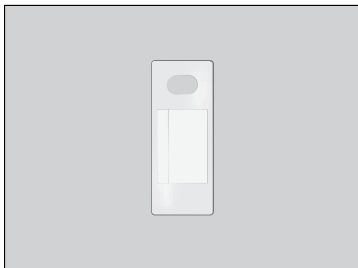

Contains a number that you will need if you purchase a replacement key.

☒ Key Number Tag

Keep the key number tag separate from the key in a safe place outside of your vehicle.
If you wish to purchase an additional key, contact a dealer.

If you lose your key and you cannot start the engine, contact a dealer.

Low Keyless Remote Signal Strength*

The vehicle transmits radio waves to locate the keyless remote when locking/unlocking the doors and tailgate, or to start the engine.

In the following cases, locking/unlocking the doors and tailgate, or starting the engine may be inhibited or operation may be unstable:

- Strong radio waves are being transmitted by nearby equipment.
- You are carrying the keyless remote together with telecommunications equipment, laptop computers, mobile phones, or wireless devices.
- A metallic object is touching or covering the keyless remote.

ⓘ Low Keyless Remote Signal Strength*

Communication between the keyless remote and the vehicle consumes the keyless remote's battery. Battery life is about two years, but this varies depending on regularity of use. The battery is consumed whenever the keyless remote is receiving strong radio waves. Avoid placing it near electrical appliances such as televisions and personal computers.

* Not available on all models

Locking/Unlocking the Doors from the Outside

■ Using the Keyless Access System *

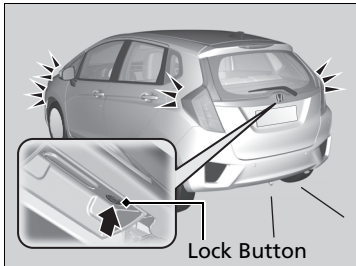
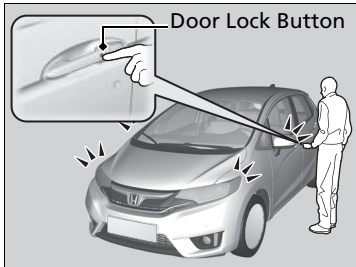
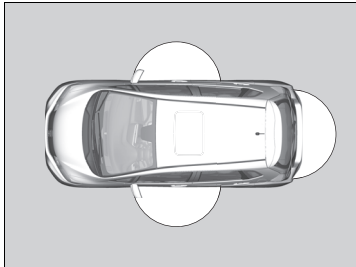

When you carry the keyless remote, you can lock/unlock the doors and tailgate. You can lock/unlock the doors and the tailgate within a radius of about 80 cm (32 inches) of the outside door handle. You can open the tailgate within about 80 cm (32 inches) radius from the tailgate release button.

■ Locking the doors and tailgate

Press the door lock button on the front door or the tailgate.

- ▶ Some exterior lights flash three times; all the doors and tailgate lock; and the security system sets.

☒ Using the Keyless Access System *

- Do not leave the keyless remote in the vehicle when you get out. Carry it with you.
- Even if you are not carrying the keyless remote, you can lock/unlock the doors and the tailgate while someone else with the remote is within range.
- The door may be unlocked if the door handle is covered with water in heavy rain or in a car wash if the keyless remote is within range.
- If you grip a front door handle wearing gloves, the door sensor may be slow to respond or may not respond by unlocking the doors.
- You cannot unlock the door by gripping the handle after two seconds of locking it.
- The door may not open if you pull it immediately after gripping the door handle. Grip the handle again and confirm that the door is unlocked before pulling the handle.
- Even within the 80 cm (32 inches) radius, you may not be able to lock/unlock the doors and the tailgate with the keyless remote if it is above or below the outside handle.
- The keyless remote may not operate if it is too close to the door and door glass.

If the distance at which the remote transmitter works varies, the battery is probably low. Replace the button battery as soon as possible.

If the LED does not come on when you press a button, the battery is dead.

☒ **Replacing the Button Battery** P. 521

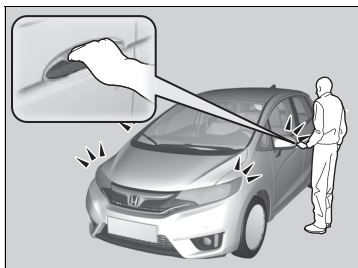

■ Unlocking the doors and the tailgate

Grab the front door handle:

- ▶ All the doors and tailgate unlock.
- ▶ Some exterior lights flash once.

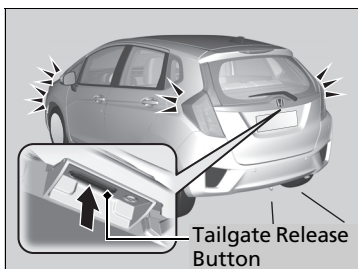

Press the tailgate release button:

- ▶ All the doors and tailgate unlock.
- ▶ Some exterior lights flash once.

☑ **Using the Tailgate Outer Handle/Release Button** P. 154

☒ Using the Keyless Access System*

If you do not open a door or the tailgate within 30 seconds of unlocking the vehicle, the doors and tailgate will automatically relock.

* Not available on all models

■ Using the Remote Transmitter

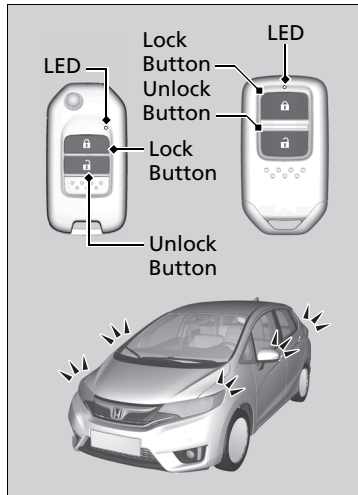

■ Locking the doors

Press the lock button.

- ▶ Some exterior lights flash three times, all the doors and tailgate lock, and the security system* sets.

▶▶ Using the Remote Transmitter

If you do not open a door or the tailgate within 30 seconds of unlocking the vehicle with the remote transmitter, the doors and tailgate will automatically relock.

If the interior light switch is in the door activated position, the interior lights come on when you press the unlock button.

No doors opened: The lights fade out after 30 seconds.

Doors relocked with the remote transmitter: The lights go off immediately.

▶ **Interior Lights** P. 194

■ Unlocking the doors

Press the unlock button.

- ▶ Some exterior lights flash once, and all doors and the tailgate unlock.

☒ Using the Remote Transmitter

The remote transmitter uses low-power signals, so the operating range may vary depending on the surroundings.

Models without keyless access system

The remote transmitter will not work when the key is in the ignition switch.

Models with keyless access system

You can lock or unlock doors using the remote transmitter or keyless access system only when the power mode is in VEHICLE OFF.

All models

The remote transmitter will not lock the vehicle when a door or the tailgate is open.

If the distance at which the remote transmitter works varies, the battery is probably low. Replace the button battery as soon as possible.

If the LED does not come on when you press a button, the battery is dead.

☒ **Replacing the Button Battery** P. 520

Locking/Unlocking the Doors Using a Key

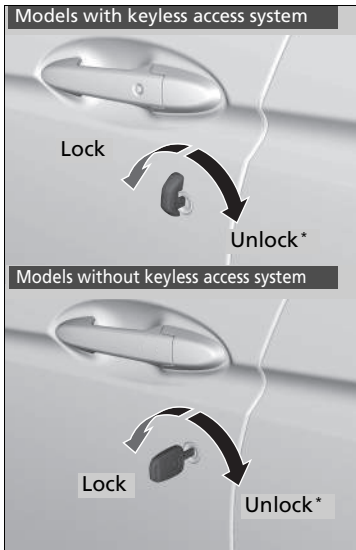

Fully insert the key and turn it.

Locking/Unlocking the Doors Using a Key

When you lock/unlock* the driver's door with the key, all the other doors and the tailgate lock/unlock* at the same time.

Unlocking the doors with the key will cause the security system* to alarm. Always unlock the doors with the remote transmitter or keyless access system*.

Models with retractable key

If you are using the retractable key, make sure it is fully extended.

■ Locking a Door Without Using a Key

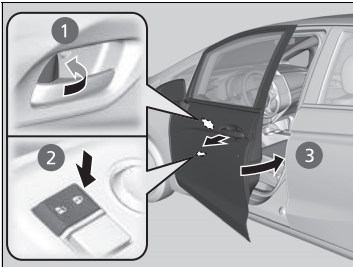

■ Locking the driver's door

Push the lock tab forward ① or push the master door lock switch in the lock direction ②, then pull and hold the outside door handle ③. Close the door, then release the handle.

■ Locking the passengers' doors

Push the lock tab forward and close the door.

■ Lockout prevention system

Models without keyless access system

The doors and the tailgate cannot be locked when the key is in the ignition switch.

Models with keyless access system

The doors and the tailgate cannot be locked when the keyless remote is inside the vehicle.

☒ Locking a Door Without Using a Key

When you lock the driver's door, all the other doors and tailgate lock at the same time.

Make sure you have the key in your hand before locking the door to prevent it from being locked in the vehicle.

Locking/Unlocking the Doors from the Inside

■ Using the Lock Tab

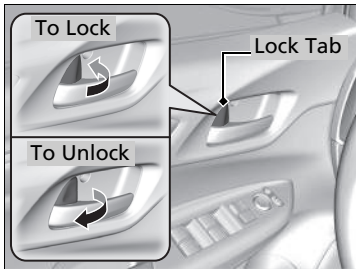

■ Locking a door

Push the lock tab forward.

■ Unlocking a door

Pull the lock tab rearward.

☞ Using the Lock Tab

When you lock/unlock the door using the lock tab on the driver's door, all the other doors and the tailgate lock/unlock at the same time.

■ Unlocking Using the Front Door Inner Handle

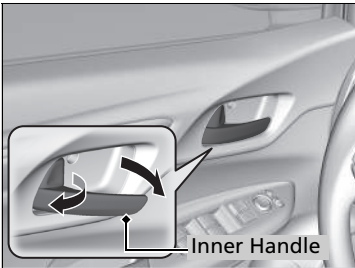

Pull the front door inner handle.

- ▶ The door unlocks and opens in one motion.

Unlocking and opening the driver's door from the inner handle unlocks all the other doors.

■ Using the Master Door Lock Switch

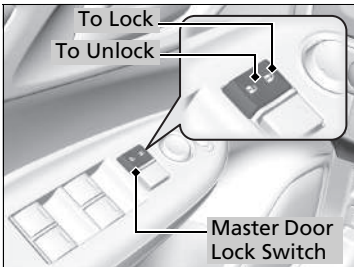

Press the master door lock switch in as shown to lock or unlock all doors and the tailgate.

☒ Unlocking Using the Front Door Inner Handle

The front door inner handles are designed to allow the front seat occupants to open the door in one motion.

However, this feature requires that front seat occupants never pull a front door inner handle while the vehicle is in motion.

Children should always ride in a rear seat where childproof door locks are provided.

☒ **Childproof Door Locks** P. 152

☒ Using the Master Door Lock Switch

When you lock/unlock the driver's door using the master lock switch, all the other doors and the tailgate lock/unlock at the same time.

Childproof Door Locks

The childproof door locks prevent the rear doors from being opened from the inside regardless of the position of the lock tab.

■ Setting the Childproof Door Locks

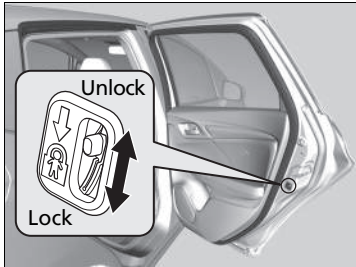

Slide the lever in the rear door to the lock position, and close the door.

■ When opening the door

Open the door using the outside door handle.

☒ Childproof Door Locks

To open the door from the inside when the childproof door lock is on, put the lock tab in the unlock position, lower the rear window, put your hand out of the window, and pull the outside door handle.

Precautions for Opening/Closing the Tailgate

Always make sure individuals and objects are clear of the tailgate before opening or closing it.

■ Opening the tailgate

- Open the tailgate all the way.
 - ▶ If it is not fully opened, the tailgate may come down accidentally by its own weight.
- Be careful when it is windy. The wind may cause the tailgate to close.

■ Closing the tailgate

Keep the tailgate closed while driving to:

- ▶ Avoid possible damage.
- ▶ Prevent exhaust gas from leaking into the vehicle.
 - **Carbon Monoxide Gas** P. 81

⚠ Precautions for Opening/Closing the Tailgate

Be careful not to hit your head on the tailgate or to put your hands between the tailgate and the luggage area when closing the tailgate.

When you are storing or picking up luggage from the luggage area while the engine is idling, do not stand in front of the exhaust pipe. You may get burned.

Do not allow any passenger in the luggage space. They may get hurt during hard braking, a sudden acceleration, or a crash.

Using the Tailgate Outer Handle/Release Button



Models with keyless access system

When all the doors are unlocked, the tailgate is unlocked. Press the tailgate release button and lift open the tailgate.

Even if the tailgate is locked, you can open the tailgate if you carry the keyless remote.



Models without keyless access system

When all the doors are unlocked, the tailgate is unlocked.

Pull up the tailgate outer handle and lift open the tailgate.

►► Using the Tailgate Outer Handle/Release Button

Models with keyless access system

- Do not leave the keyless remote in the vehicle when you get out. Carry it with you.
- A person who is not carrying the keyless remote can unlock the tailgate if a person who is carrying it is within range.

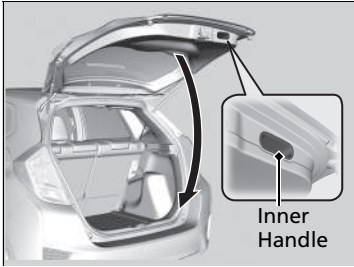

All models

To close the tailgate, grab the inner handle, pull the tailgate down, and push it closed from outside.

Immobilizer System

The immobilizer system prevents a key that has not been pre-registered from starting the engine. Each key contains electronic transmitters that use electronic signals to verify the key.

Pay attention to the following when inserting the key into the ignition switch or pressing the **ENGINE START/STOP** button:

- Do not allow objects that emit strong radio waves near the ignition switch or the **ENGINE START/STOP** button.
- Make sure the key is not covered by or touching a metal object.
- Do not bring a key from another vehicle's immobilizer system near the ignition switch.

Security System Alarm *

The security system alarm activates when the doors, tailgate, or bonnet are opened without the remote transmitter or keyless access system.

■ When the security system alarm activates

The horn sounds intermittently and the turn signal lights flash.

■ To deactivate the security system alarm

Unlock the vehicle using the remote transmitter or keyless access system, or turn the ignition switch to ON *1. The system, along with the horn and flashing lights, is deactivated.

*1 : Models with the keyless access system have an **ENGINE START/STOP** button instead of an ignition switch.

* Not available on all models

» Immobilizer System

NOTICE

Leaving the ignition key in the vehicle can result in theft or accidental movement of the vehicle. Always take the ignition key with you whenever you leave the vehicle unattended.

If the system repeatedly does not recognize the coding of your key, contact your dealer. If you have lost your key and cannot start your engine, contact your dealer.

Do not alter the system or add other devices to it. Doing so may damage the system and make your vehicle inoperable.

» Security System Alarm *

The security alarm continues for 30 seconds, then the system resets. If the cause of the alarm continues, alarming will repeat several times at about 5 second intervals.

■ Setting the security system alarm

The security system alarm automatically sets when the following conditions have been met:

- The ignition switch is in LOCK *1.
- The bonnet and tailgate are closed.
- All doors and the tailgate are locked from outside with the key, the remote transmitter, or keyless access system.

Models without keyless access system

- The key has been removed from the ignition switch.

■ When the security system alarm sets

The security system alarm indicator in the instrument panel blinks. When the blinking interval changes after about 15 seconds, the security system alarm is set.

■ To cancel the security system alarm

The security system alarm is cancelled when the vehicle is unlocked using the remote transmitter, keyless access system or the ignition switch is turned to ON *1. The security system alarm indicator goes off at the same time.

*1: Models with the keyless access system have an **ENGINE START/STOP** button instead of an ignition switch.

* Not available on all models

Security System Alarm*

Do not set the security system alarm when someone is in the vehicle or a window is open. The system can accidentally activate when the door is unlocked with the lock tab.

If the battery goes dead after you have set the security system alarm, the security alarm may go off once the battery is recharged or replaced. If this occurs, deactivate the security system alarm by unlocking a door using the remote transmitter or keyless access system.

Do not attempt to alter this system or add another device to it.

Do not unlock the door using the key. The security system alarm goes off.

Super Locking*

The super locking function disables the lock tabs on all doors.

■ To activate the super locking function

- Turn the key in the driver's door towards the vehicle front twice within five seconds.
- Press the lock button on the remote transmitter twice within five seconds.

Models with keyless access system

- Press the door lock button on the door handle or the tailgate twice within five seconds.

■ To cancel the super locking function

Unlock the driver's door with the remote transmitter or keyless access system.

Super Locking*

WARNING

No one must be inside the vehicle with the super locking set. Persons locked in can get seriously sick or die from the heat built inside the vehicle if left in the sun.

Make sure there is no one inside the vehicle before setting the super locking.

Do not unlock the door using the key. The security system alarm goes off.

Opening/Closing the Power Windows

The power windows can be opened and closed when the ignition switch is in ON ^{*1}, using the switches on the doors. The driver's side switches can be used to open and close all of the windows.

The power window lock button on the driver's side must be switched off (not pushed in, indicator off) to open and close the windows from anywhere other than the driver's seat.

When the power window lock button is pushed in, the indicator comes on and you can only operate the driver's window. Turn the power window lock button on when children are in the vehicle.

Opening/Closing Windows with Auto-Open/Close Function

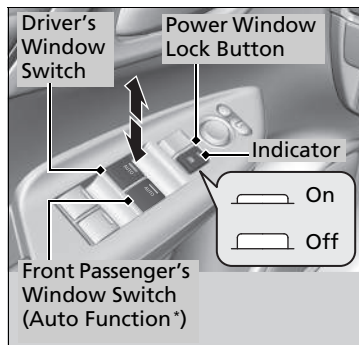

Automatic operation

To open: Push the switch down firmly.

To close: Pull the switch up firmly.

The window opens or closes completely. To stop the window at any time, push or pull the switch briefly.

Manual operation

To open: Push the switch down lightly, and hold it until the desired position is reached.

To close: Pull the switch up lightly, and hold it until the desired position is reached.

*1: Models with the keyless access system have an **ENGINE START/STOP** button instead of an ignition switch.

* Not available on all models

Opening/Closing the Power Windows

WARNING

Closing a power window on someone's hands or fingers can cause serious injury.

Make sure your passengers are away from the windows before closing them.

WARNING: Always take the ignition key with you whenever you leave the vehicle alone (with other occupants).

The power windows can be operated for up to 10 minutes after you turn the ignition switch to LOCK ^{*1}. Opening either front door cancels this function.

Auto Reverse

If a power window senses resistance when closing automatically, it will stop closing and reverse direction.

The driver's window auto reverse function is disabled when you continuously pull up the switch.

The auto reverse function stops sensing when the window is almost closed to ensure that it fully closes.

■ Opening/Closing Windows without Auto-Open/Close Function

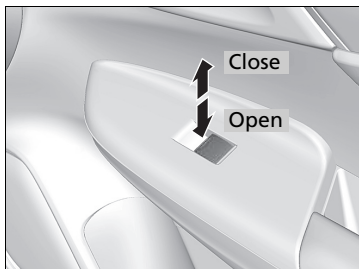

To open: Push the switch down lightly, and hold it until the desired position is reached.

To close: Pull the switch up lightly, and hold it until the desired position is reached.

Operating the Switches Around the Steering Wheel

Models without keyless access system

Ignition Switch

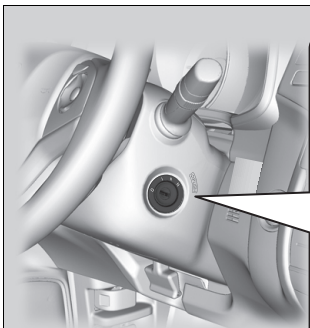

- 0** LOCK: Insert and remove the key in this position.
- I** ACCESSORY: Operate the audio system and other accessories in this position.
- II** ON: This is the position when driving.
- III** START: This position is for starting the engine. The switch returns to ON **II** when you let go of the key.

Ignition Switch

Manual transmission models

⚠ WARNING

Removing the key from the ignition switch while driving locks the steering. This can cause you to lose control of the vehicle.



Remove the key from the ignition switch only when parked.

Continuously variable transmission models

You cannot take the key out unless the shift lever is in **P**.

All models

If you open the driver's door when the key is in LOCK **0** or ACCESSORY **I**, the following symbol appears on the multi-information display:

- In LOCK **0**: symbol 
- In ACCESSORY **I**: symbol 

If the key won't turn from LOCK **0** to ACCESSORY **I**, turn the key while moving the steering wheel left and right. The steering wheel will unlock, allowing the key to turn.

Models with keyless access system

ENGINE START/STOP Button

■ Changing the Power Mode

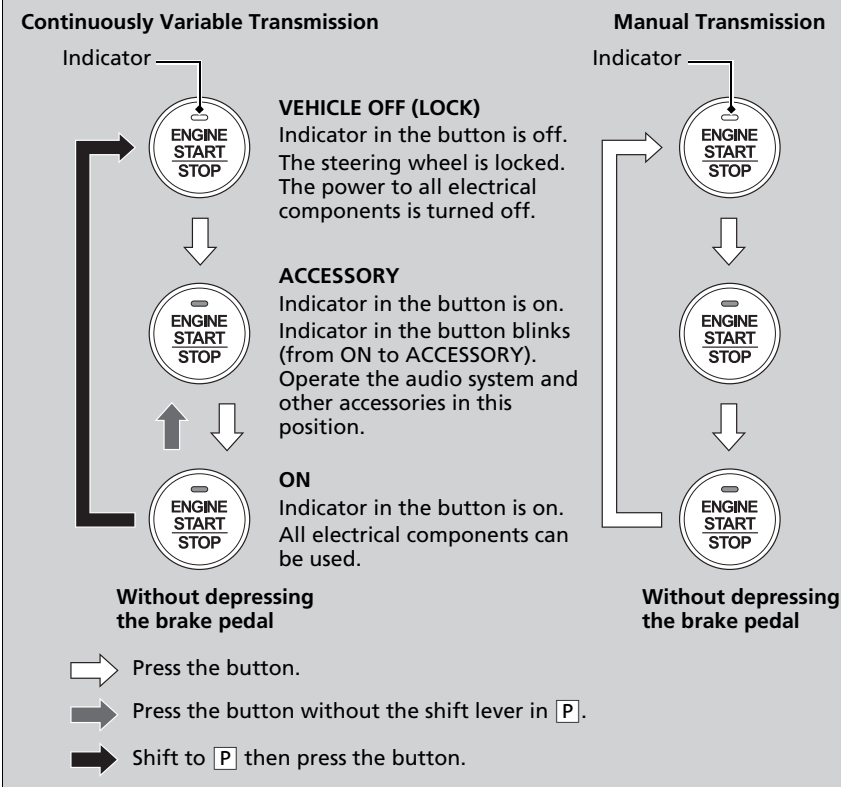

▶▶ ENGINE START/STOP Button

ENGINE START/STOP Button Operating Range

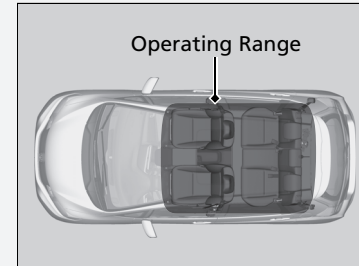

You can start the engine when the keyless remote is inside the vehicle.

The engine may also run if the keyless remote is close to the door or window, even if it is outside the vehicle.

ON mode:

Indicator in the button is off, if the engine is running.

If the keyless remote battery is weak, beeper sounds and  appears on the multi-information display.

▶▶ If the Keyless Remote Battery is Weak

P. 552

Automatic Power Off

If you leave the vehicle for 30 to 60 minutes with the shift lever in **P***1 and the power mode in ACCESSORY, the vehicle automatically goes into the mode similar to VEHICLE OFF (LOCK) to avoid the battery drain.

When in this mode:

The steering wheel does not lock.

You cannot lock or unlock doors with the remote transmitter or the keyless access system.

Press the **ENGINE START/STOP** button to switch the mode to VEHICLE OFF (LOCK).

🔧 **Changing the Power Mode** P. 162

ENGINE START/STOP Button

Do not leave the power mode in ACCESSORY or ON when you get out.

If the power mode does not change from VEHICLE OFF to ACCESSORY, press the **ENGINE START/STOP** button while moving the steering wheel left and right. The steering wheel will unlock, allowing the mode to change.

*1: Continuously variable transmission models

■ Power Mode Reminder

If you open the driver's door when the power mode is set to ACCESSORY, a warning buzzer sounds.

■ Keyless Remote Reminder



Warning buzzers may sound from inside or/ and outside the vehicle to remind you that the keyless remote is out of the vehicle. If the buzzer continues even after the remote is put back inside, place it to be within its operational range.

■ When the power mode is in ON

If the keyless remote is taken out of the vehicle, and the driver's door is closed, warning buzzers sound from both inside and outside the vehicle. A warning symbol on the multi-information display notifies the driver inside that the remote is out.

■ When the power mode is in ACCESSORY

If the keyless remote is taken out of the vehicle, and all the doors are closed, a warning buzzer sounds from outside the vehicle.

☒ Keyless Remote Reminder

When the keyless remote is within the system's operational range, and the driver's door is closed, the warning function cancels.

If the keyless remote is taken out of the vehicle after the engine has been started, you can no longer change the **ENGINE START/STOP** button mode or restart the engine. Always make sure if the remote is in your vehicle when you operate the **ENGINE START/STOP** button.

Removing the keyless remote from the vehicle through a window does not activate the warning buzzer.

Do not put the keyless remote on the dashboard or in the glove box. It may cause the warning buzzer to go off. Under some other conditions that can prevent the vehicle from locating the remote, the warning buzzer may also go off even if the remote is within the system's operational range.

Ignition Switch and Power Mode Comparison

Ignition Switch Position	LOCK 0 (with/without the key)	ACCESSORY I	ON II	START III
Without Keyless Access System	<ul style="list-style-type: none"> • Engine is turned off and power is shut down. • The steering wheel is locked. • No electrical components can be used. 	<ul style="list-style-type: none"> • Engine is turned off. • Some electrical components such as the audio system and the accessory power socket can be operated. 	<ul style="list-style-type: none"> • Normal key position while driving. • All electrical components can be used. 	<ul style="list-style-type: none"> • Use this position to start the engine. • The ignition switch returns to ON II position when you release the key.
Power Mode	VEHICLE OFF (LOCK)	ACCESSORY	ON	START
With Keyless Access System and ENGINE START/STOP Button	Indicator-Off <ul style="list-style-type: none"> • Engine is turned off and power is shut down. • The steering wheel is locked. • No electrical components can be used. 	Indicator-On or blinking <ul style="list-style-type: none"> • Engine is turned off. • Some electrical components such as the audio system and the accessory power socket can be operated. 	Indicator-On (engine is turned off) Indicator-Off (engine is running) <ul style="list-style-type: none"> • All electrical components can be used. 	Indicator-Off <ul style="list-style-type: none"> • The mode automatically returns to ON after the engine starts.

Turn Signals

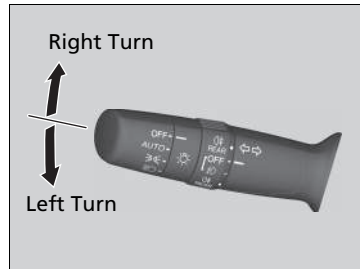

The turn signals can be used when the ignition switch is in ON **II***1.

■ One-push turn signal

When you lightly push up or down and release the turn signal lever, the exterior turn signals and turn signal indicator blink three times.

This feature can be used when signalling for a lane change.

*1 : Models with the keyless access system have an **ENGINE START/STOP** button instead of an ignition switch.

Light Switches

Manual Operation

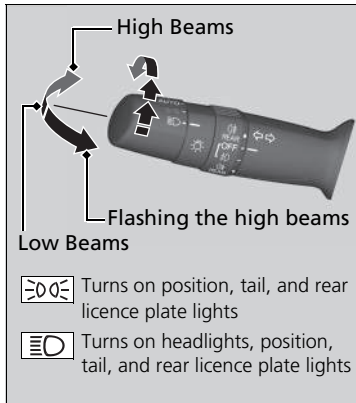

Rotating the light switch turns the lights on and off, regardless of the position of the ignition switch*1.

High beams

Push the lever forward until you hear a click.

Low beams

When in high beams, pull the lever back to return to low beams.

Flashing the high beams

Pull the lever back, and release it.

Light Switches

Models without keyless access system

If you remove the key from the ignition switch while the lights are on, a chime sounds when the driver's door is opened.

Models with keyless access system

If you leave the power mode in VEHICLE OFF (LOCK) while the lights are on, a chime sounds when the driver's door is opened.

If you sense that the level of the headlights is abnormal, have your vehicle inspected by a dealer.

Do not leave the lights on when the engine is off because it will cause the battery to discharge.

*1: Models with the keyless access system have an **ENGINE START/STOP** button instead of an ignition switch.

■ Automatic Lighting Control

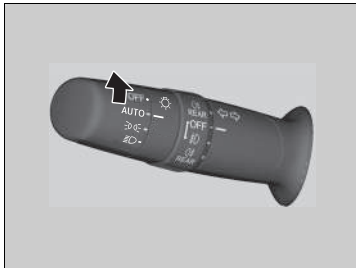



Automatic lighting control can be used when the ignition switch is in ON *1.

When you turn the light switch to **AUTO**, the headlights and other exterior lights will switch on and off automatically depending on the ambient brightness.

■ Automatic Lighting Off Feature

The headlights, all other exterior lights, and the instrument panel lights turn off 15 seconds after you remove the key or set the power mode to VEHICLE OFF (LOCK), take the remote with you, and close the driver's door.

However, when the switch is in , the position lights remain on.

If you turn the ignition switch to LOCK *1 with the headlight switch on, but do not open the door, the lights turn off after 10 minutes (3 minutes, if the switch is in the **AUTO** position).

The lights turn on again when you unlock or open the driver's door. If you unlock the door, but do not open it within 15 seconds, the lights go off. If you open the driver's door, you will hear a lights on reminder chime.

*1 : Models with the keyless access system have an **ENGINE START/STOP** button instead of an ignition switch.

▶▶ Automatic Lighting Control

We recommend that you turn on the lights manually when driving at night, in a dense fog, or in dark areas such as long tunnels or parking facilities.

The light sensor is in the location shown below. Do not cover this light sensor with anything; otherwise, the automatic lighting system may not work properly.

Models with automatic intermittent wipers

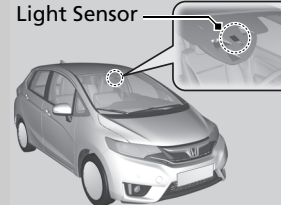

Models without automatic intermittent wipers

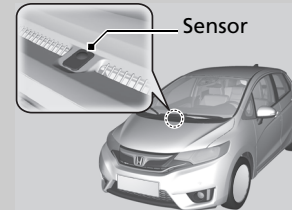

▶▶ Automatic Lighting Off Feature

You can change the headlight auto off timer setting.

 **Customized Features** P. 129

Fog Lights

■ Front fog lights*

Can be used when the position lights or the headlights are on.



■ Rear fog light

Can be used when the headlights or the front fog lights are on.

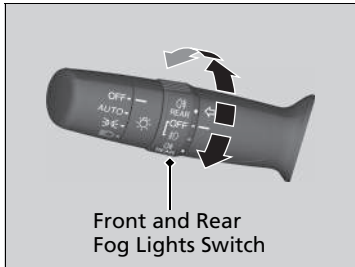

■ Front and Rear Fog Lights Switch *



■ To turn the front fog lights on

Rotate the switch up from the **OFF** position to the  position. The  indicator comes on.

■ To turn the front and rear fog lights on

Rotate the switch one position up from the  position. The  and  indicator comes on.

■ To turn the rear fog light on



Rotate the switch down from the **OFF** position. The  indicator comes on.

* Not available on all models

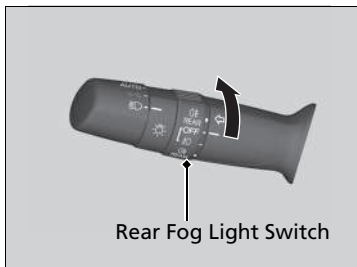
■ Rear Fog Lights*



■ To turn the rear fog light on

Rotate the switch to . The  indicator comes on.

Headlight Adjuster

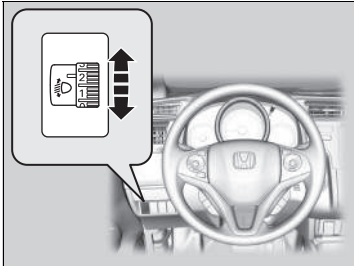

You can adjust the vertical angle of the low beam headlights when the ignition switch is in ON *1.

The larger dial number indicates the lower angle.

■ To select the adjusting dial position

Refer to the below table for the appropriate dial position for your vehicle's riding and loading conditions.

Condition	Dial position
A driver	0
A driver and a front passenger	0
Five persons in the front and rear seats	1
Five persons in the front and rear seats and luggage in the luggage area, within the limit of maximum permissible axle weight and maximum permissible vehicle weight	2
A driver and luggage in the luggage area, within the limits of maximum permissible axle weight and maximum permissible vehicle weight	3

*1: Models with the keyless access system have an **ENGINE START/STOP** button instead of an ignition switch.

Headlight Adjuster

You may need to alter the headlight beam distribution.

▶ **Adjusting Headlight Distribution** P. 445

High Beam Support System*

Uses the camera attached, monitors the space ahead of your vehicle, and automatically changes the low beam headlights to high beam headlights when necessary.

The system operates when:

- The headlight switch is in **AUTO**.
- The lever is in the low beam position.
- The system recognises that you are driving at night and the low beam headlights come on.
- The vehicle speed is above 40 km/h (25 mph).

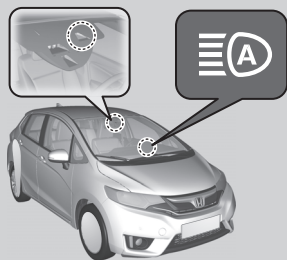

The system changes between high and low beam headlights when:

The camera is not detecting any lights coming from preceding or oncoming vehicles: The headlights change to high beams.

The camera detects lights coming from a preceding or oncoming vehicle: The headlights are returned to low beams.

The camera monitors the range within the 38-degree view angle. The distance that the camera can detect lights ahead differs depending on conditions, such as the brightness of the lights and the weather.

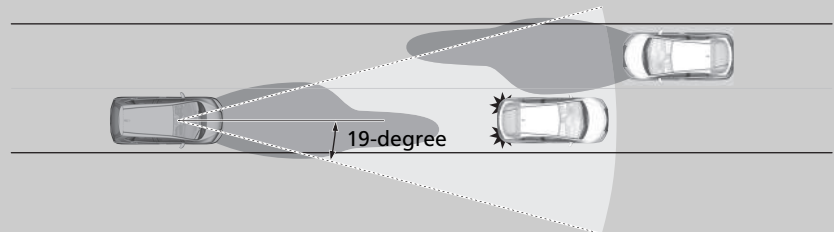

High Beam Support System*

The high beam support system determines when to change the headlight beams by responding to the brightness of the lights ahead of your vehicle. In the following cases, the system may not respond to the lights properly:

- The brightness of the lights from the preceding or oncoming vehicle is intense or poor.
- Visibility is poor due to the weather (rain, snow, fog, windscreen frost, etc.).
- Other light sources, such as streetlights and electric billboards are illuminating the road ahead.
- The brightness level of the road ahead constantly changes.
- The road is bumpy or with many curves.
- A vehicle cuts in front of you, or a vehicle in front of you is not in the preceding or oncoming direction.
- Your vehicle is tilted with a heavy load in the rear.

If you find the timing of beam changes inconvenient for driving, change the headlight beams manually.

If you do not want the system to be activated at any time when the headlight switch is in **AUTO**, consult a dealer.

■ To Operate the System

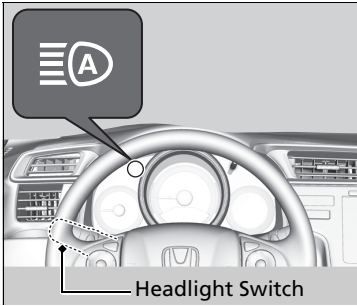

Turn the headlight switch in **AUTO** and pull the headlight lever to low beam.

📖 **Light Switches** P. 167

The high beam support system indicator comes on.

■ Temporary cancellation

The high beam support system operation is temporarily cancelled while:

- You are continuously driving at a speed below 24 km/h (15 mph).
- The vehicle speed is below 10 km/h (6 mph).
- The windscreen wipers run at high speed for more than a few seconds.

The system operation resumes once the condition that caused it to cancel improves.

📖 To Operate the System

For the high beam support system to work properly:

- Do not place an object that reflects light on the dashboard.
- Keep the windscreen around the camera clean. When cleaning the windscreen, be careful not to apply the windscreen cleanser to the camera lens.
- Do not attach an object, sticker or film in the area around the camera.
- Do not touch the camera lens.

If the camera receives a strong impact, or repairing of the area near the camera is required, consult a dealer.

To help reduce the likelihood that high interior temperatures will cause the camera system to shut off, when parking, find a shady area or face the front of the vehicle away from the sun.

If you use a reflective sun shade, do not allow it to cover the camera housing. Covering the camera can concentrate heat on the camera.

If the  message appears:

- Use the heating and cooling system*/climate control system* to cool down the interior and, if necessary, the demister mode when windows are fogged.
- Start driving the vehicle to lower the windscreen temperature, which cools down the area around the camera.

* Not available on all models

■ To manually cancel the system temporarily

You can cancel the operation when you manually change the headlights to high beams. Push the lever forward until you hear a click, or lightly pull the lever towards you to flash high beams. The high beam support system indicator goes off.

If you want the high beam support system operation to resume at once, pull and hold the lever towards you for a few seconds.

Daytime Running Lights

The daytime running lights come on when the following conditions have been met:

- The ignition switch is in ON *1.
- The headlight switch is off.

🔧 To Operate the System

If the  message appears:
Park your vehicle in a safe place. Wipe away debris blocking the windscreen, then start driving again. If the message remains on even after driving for a while with the clean windscreen, have your vehicle checked by a dealer.

*1 : Models with the keyless access system have an **ENGINE START/STOP** button instead of an ignition switch.

Wipers and Washers

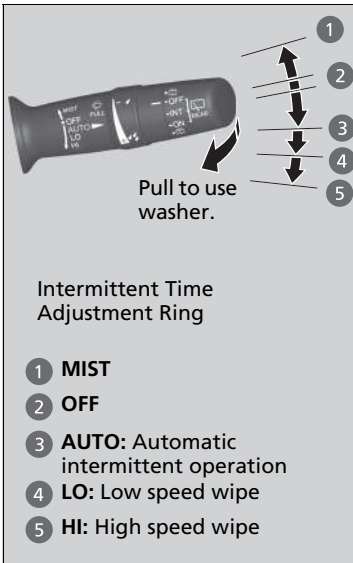

The windscreen wipers and washers can be used when the ignition switch is in ON **II***1.

■ MIST

The wipers run at high speed until you release the lever.

■ Wiper switch (OFF, AUTO, LO, HI)

Change the wiper switch setting according to the amount of rain.

🔍 **Automatic Intermittent Wipers** P. 176

■ Washer

Sprays while you pull the lever toward you. When you release the lever for more than one second, the spray stops, the wipers sweep two or three more times to clear the windscreen, then stop.

🔍 Wipers and Washers

NOTICE

Do not use the wipers when the windscreen is dry. The windscreen will get scratched, or the rubber blades will get damaged.

NOTICE

In cold weather, the blades may freeze to the windscreen, becoming stuck. Operating the wipers in this condition may damage the wipers. Use the demister to warm the windscreen, then turn the wipers on.

Turn the washers off if no washer fluid comes out. The pump may get damaged.

The wiper motor is equipped with a breaker that may stop motor operation temporarily to prevent an overload. Wiper operation will return to normal within a few minutes, once the circuit has returned to normal.

If the wipers stop operating due to any obstacle such as the build-up of snow, park the vehicle in a safe place.

Rotate the wiper switch to **OFF**, and turn the ignition switch to ACCESSORY **I** or LOCK **0***1, then remove the obstacle.

*1: Models with the keyless access system have an **ENGINE START/STOP** button instead of an ignition switch.

■ Automatic Intermittent Wipers

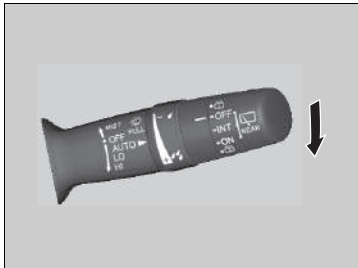

When you push the lever down to **AUTO**, the windscreen wipers sweep once, and go into the automatic mode.

The wipers operate intermittently, at low speed, or at high speed and stops in accordance with the amount of rainfall the rainfall sensor detects.

■ AUTO sensitivity adjustment

When in **AUTO**, you can also adjust the rainfall sensor sensitivity using the intermittent time adjustment ring.

Sensor sensitivity



Low sensitivity:
Lower speed, fewer sweeps

High sensitivity:
Higher speed, more sweeps

▶▶ Automatic Intermittent Wipers

The rainfall sensor is in the location shown below.

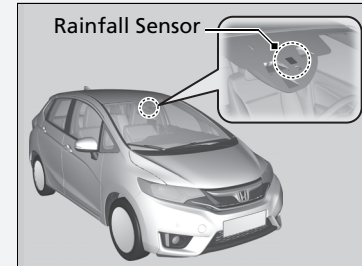

Do not put the wiper lever in **AUTO** when cleaning the windscreen or driving through a car wash. If the wiper lever is in **AUTO**, and the ignition switch is in ON **II**^{*1}, the rainfall sensor may respond to your hand or car wash liquids, and the wipers may operate automatically.

*1: Models with the keyless access system have an **ENGINE START/STOP** button instead of an ignition switch.

■ Rear Wiper/Washer

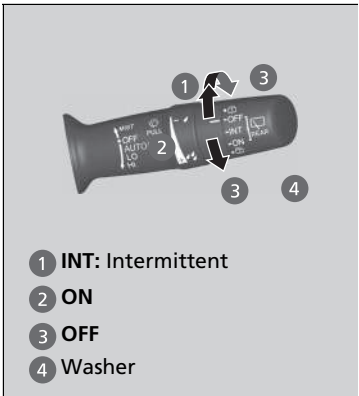

- 1 INT: Intermittent
- 2 ON
- 3 OFF
- 4 Washer

The rear wiper and washer can be used when the ignition switch is in ON *1.

■ Wiper switch (OFF, INT, ON)

The wiper operates intermittently after completing a few sweeps.

■ Washer ()

Sprays while you rotate the switch to this position.
Hold it to activate the wiper and to spray the washer. Once released, it stops operating after a few more sweeps.

■ Operating in reverse



When you shift the transmission to R with the windscreen wipers activated, the rear wiper operates automatically as follows even if its switch is off.

Front Wiper Position	Rear Wiper Operation
AUTO (Intermittent)	Intermittent
LO (Low speed wipe)	Continuous
HI (High speed wipe)	

*1: Models with the keyless access system have an **ENGINE START/STOP** button instead of an ignition switch.

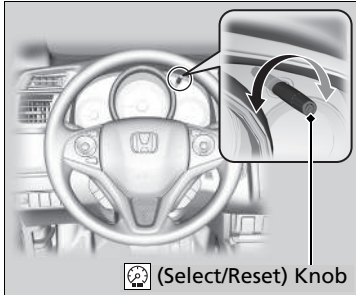
Brightness Control



When the ignition switch is in ON *1, you can use the  (Select/Reset) knob to adjust instrument panel brightness.

Brighten: Turn the knob to the right.

Dim: Turn the knob to the left.

The multi-information display will return to its original state several seconds after you adjust the brightness.

■ Brightness level indicator

The brightness level is shown on the multi-information display while you are adjusting it.



▶▶ Brightness Control

Instrument panel brightness varies, depending on whether the exterior lights are on or off. The instrument panel dims to reduce glare when they are on.

Pressing the  knob switches the display.

Turn the knob to the right until the brightness display is up to max. This cancels the reduced instrument panel brightness when the exterior lights are on.

The brightness can be set differently for when the exterior lights are on, and when they are off.

*1 : Models with the keyless access system have an **ENGINE START/STOP** button instead of an ignition switch.

Rear Demister/Heated Door Mirror*

Press the rear demister and heated door mirror button or touch the icon to defog the rear window and mirrors when the ignition switch is in ON *1.

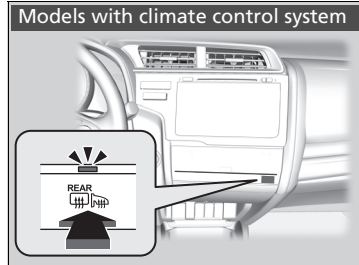
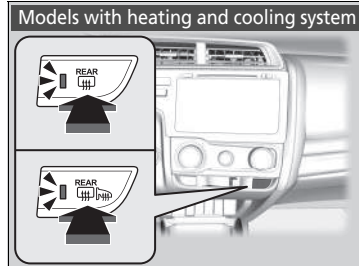

Models with climate control system

The rear demister and heated door mirrors automatically switch off after 10-30 minutes depending on the outside temperature. However, if the outside temperature is 0°C or below, they do not automatically switch off.

⊗ Rear Demister/Heated Door Mirror*

NOTICE

When cleaning the inside of the rear window, be careful not to damage the heating wires. It is critical to wipe the window from side to side along the demister heating wires.

This system consumes a lot of power, so turn it off when the window has been defogged. Also, do not use the system for a long period when the engine is idling. This may weaken the battery, making it difficult to start the engine.

*1: Models with the keyless access system have an **ENGINE START/STOP** button instead of an ignition switch.

* Not available on all models

Adjusting the Steering Wheel

The steering wheel height and distance from your body can be adjusted so that you can comfortably grip the steering wheel in an appropriate driving posture.

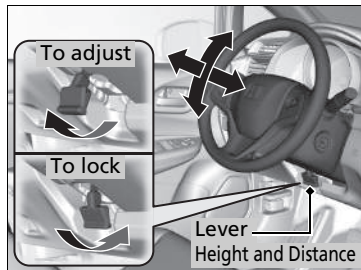

1. Pull the steering wheel adjustment lever up.
 - ▶ The steering wheel adjustment lever is under the steering column.
2. Move the steering wheel up or down, and in or out.
 - ▶ Make sure you can see the instrument panel gauges and indicators.
3. Push the steering wheel adjustment lever down to lock the steering wheel in position.
 - ▶ After adjusting the position, make sure you have securely locked the steering wheel in place by trying to move it up, down, in, and out.

Adjusting the Steering Wheel

WARNING

Adjusting the steering wheel position while driving may cause you to lose control of the vehicle and be seriously injured in a crash.

Adjust the steering wheel only when the vehicle is stopped.

Make any steering wheel adjustments before you start driving.

Interior Rearview Mirror

Adjust the angle of the rearview mirror when you are sitting in the correct driving position.

Rearview Mirror with Day and Night Positions

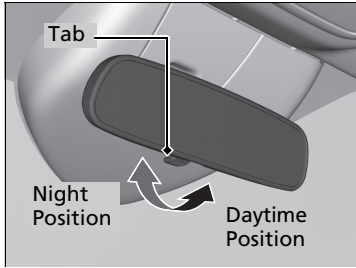

Flip the tab to switch the position. The night position will help to reduce the glare from headlights behind you when driving after dark.

Adjusting the Mirrors

Keep the inside and outside mirrors clean and adjusted for best visibility.

Adjust the mirrors before you start driving.

➤ **Adjusting the Seat Positions** P. 183

Power Door Mirrors

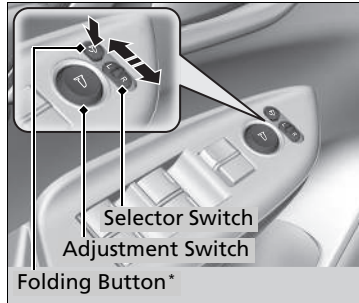

You can adjust the door mirrors when the ignition switch is in ON *1.

■ Mirror position adjustment

L/R selector switch: Select the left or right mirror. After adjusting the mirror, return the switch to the centre position.

Mirror position adjustment switch: Press the switch left, right, up, or down to move the mirror.

■ Folding door mirrors*

Press the folding button to fold in and out the door mirrors.

*1: Models with the keyless access system have an **ENGINE START/STOP** button instead of an ignition switch.

* Not available on all models

Adjusting the Seat Positions

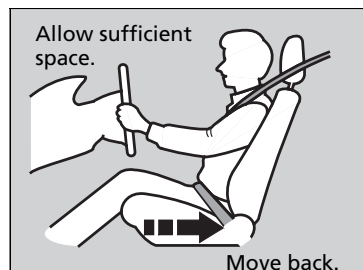

Adjust the driver's seat as far back as possible while allowing you to maintain full control of the vehicle. You should be able to sit upright, well back in the seat and be able to adequately press the pedals without leaning forward, and grip the steering wheel comfortably. The passenger's seat should be adjusted in a similar manner, so that it is as far back from the front airbag in the dashboard as possible.

■ Adjusting the front seat

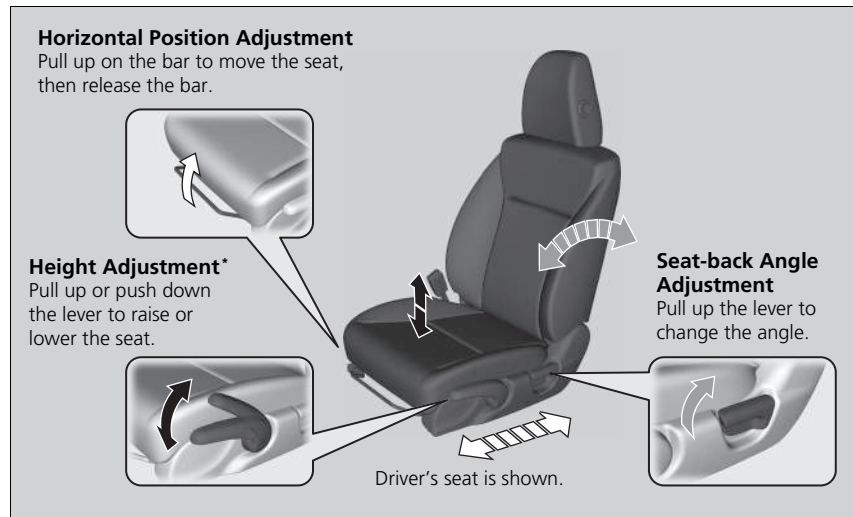

* Not available on all models

Continued

Adjusting the Seats

⚠ WARNING

Sitting too close to a front airbag can result in serious injury or death if the front airbags inflate.

Always sit as far back from the front airbags as possible while maintaining control of the vehicle.

In addition to the seat adjustment, you can adjust the steering wheel up and down, in and out. Allow at least 25 cm (10 inches) between the centre of the steering wheel and the chest.

Always make seat adjustments before driving.

Once a seat is adjusted correctly, rock it back and forth to make sure it is locked in position.

■ Adjusting the Seat-Backs

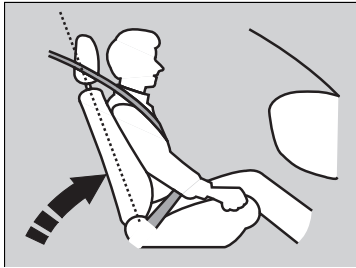

Adjust the driver's seat-back to a comfortable, upright position, leaving ample space between your chest and the airbag cover in the centre of the steering wheel.

The front seat passenger should also adjust their seat-back to a comfortable, upright position.

Reclining a seat-back so that the shoulder part of the belt no longer rests against the occupant's chest reduces the protective capability of the belt. It also increases the chance of sliding under the belt in a crash and being seriously injured. The farther a seat-back is reclined, the greater the risk of injury.

► Adjusting the Seat-Backs

⚠ WARNING

Reclining the seat-back too far can result in serious injury or death in a crash.

Adjust the seat-back to an upright position, and sit well back in the seat.

Do not put a cushion, or other object, between the seat-back and your back.

Doing so may interfere with proper seat belt or airbag operation.

If you cannot get far enough away from the steering wheel and still reach the controls, we recommend that you investigate whether some type of adaptive equipment may help.

Adjusting the Head Restraints

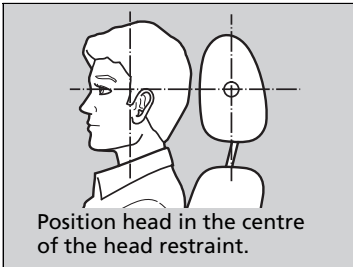

Your vehicle is equipped with head restraints in all seating positions.

Head restraints are most effective for protection against whiplash and other rear-impact crash injuries when the centre of the back of the occupant's head rests against the centre of the restraint. The tops of the occupant's ears should be level with the centre height of the restraint.

The front head restraints can also be tilted to adjust its position properly.

Adjusting the Head Restraints

⚠ WARNING

Improperly positioning head restraints reduces their effectiveness and increases the likelihood of serious injury in a crash.

Make sure head restraints are in place and positioned properly before driving.

For head restraint system to work properly.

- Do not hang any items on the head restraints, or from the restraint legs.
- Do not place any object between an occupant and the seat-back.
- Install each restraint in its proper location.

■ Adjusting the front head restraint positions

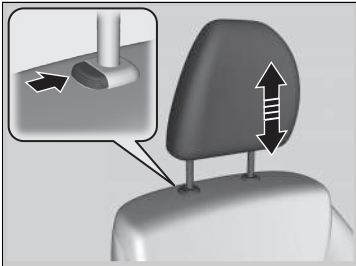

To raise the head restraint: Pull it upward.

To lower the head restraint: Push it down while pressing the release button.

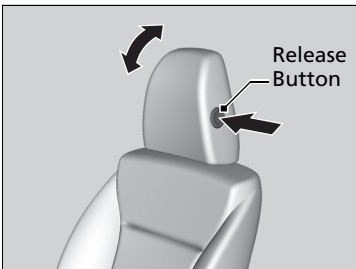

To tilt the head restraint: Pivot it while pressing the release button.

■ Changing the Rear Seat Head Restraint Positions

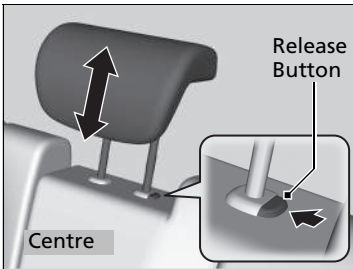
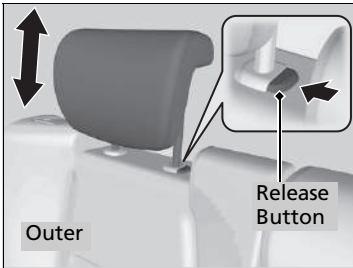

A passenger sitting in a back seating position should adjust the height of their head restraint to an appropriate position before the vehicle begins moving.

To raise the head restraint:

Pull it upward.

To lower the head restraint:

Push it down while pressing the release button.

☒ Changing the Rear Seat Head Restraint Positions

When you use the head restraint in a rear seating position, pull up the head restraint to its highest position. Do not use it in any lower position.

■ Removing and Reinstalling the Head Restraints

Head restraints can be removed for cleaning or repair.

To remove a head restraint:

Pull the restraint up as far as it will go. Then push the release button, and pull the restraint up and out.

To reinstall a head restraint:

Insert the legs back in place, then adjust the head restraint to an appropriate height while pressing the release button. Pull up on the restraint to make sure it is locked in position.

■ Maintain a Proper Sitting Position

After all occupants have adjusted their seats and head restraints, and put on their seat belts, it is very important that they continue to sit upright, well back in their seats, with their feet on the floor, until the vehicle is safely parked and the engine is off.

Sitting improperly can increase the chance of injury during a crash. For example, if an occupant slouches, lies down, turns sideways, sits forward, leans forward or sideways, or puts one or both feet up, the chance of injury during a crash is greatly increased.

In addition, an occupant who is out of position in the front seat can be seriously or fatally injured in a crash by striking interior parts of the vehicle or being struck by an inflating front airbag.

⌘ Removing and Reinstalling the Head Restraints

WARNING

Failure to reinstall, or correctly reinstall, the head restraints can result in severe injury during a crash.

Always replace the head restraints before driving.

⌘ Maintain a Proper Sitting Position

WARNING

Sitting improperly or out of position can result in serious injury or death in a crash.

Always sit upright, well back in the seat, with your feet on the floor.

Reclining the Front Seats

Reclining the seat-backs on the front seats until they are level with the rear seat cushions provides a large cushioned area that can (and should only) be used when the vehicle is safely parked.

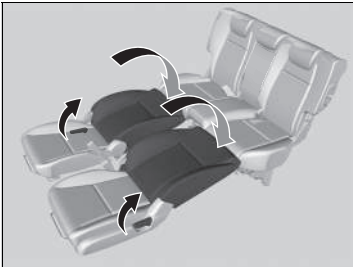

1. Remove the front head restraints while pushing the release button.
▶ Store the head restraints in the luggage area.
2. Adjust the front seats forward as far as possible.
3. While pulling the seat-back angle adjustment lever, pivot the seat-back backward until it is level with the rear seat cushion.
4. Move the front seat backward until it touches the rear seat.
5. Unlatch the detachable anchor from the anchor buckle, and store the rear centre seat belt.
▶ **Seat Belt with Detachable Anchor** P. 45
6. Adjust the rear seat-back to the desired position.

To return the front seats and rear centre seat belt to their original positions, reverse this procedure.

When you return a seat-back to its upright position, hold the seat-back to keep it from going up too quickly.

Reclining the Front Seats

Both front seats must be returned to their normal upright position, and the head restraints reinstalled and properly adjusted before driving.

▶ Removing and Reinstalling the Head Restraints P. 188

Rear Seats

■ Adjusting the Rear Seat-Backs

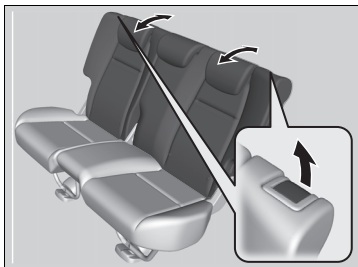

Pull the lever on the right to change the angle of the right half of the seat-back, and left for the left half.

Folding Down the Rear Seats

The rear seats can be folded down separately to allow for additional storage space.

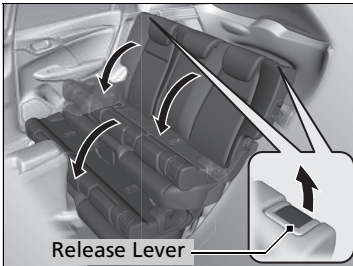
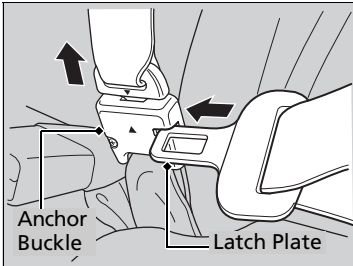

To fold down the seat

1. Store the centre seat belt first. Insert the latch plate into the slot on the side of the anchor buckle.
2. Retract the seat belt into the holder on the ceiling.
- Seat Belt with Detachable Anchor** P. 45
3. Lower the head restraint to its lowest position.
4. Pull the release lever and fold down the seat-back.

To return the seat to the original position, pull up the seat-back in the upright position.

Folding Down the Rear Seats

Make sure all items in the luggage area or items extending to the rear seats are properly secured. Loose items can fly forward if you have to brake hard.

Remove any items from the rear seat cushion and floor before you fold down the rear seat.

To lock the seat-back upright, push it backwards until it locks.

Make sure the seat-back, head restraints and seat cushion are securely latched back into place before driving. Also, make sure all rear shoulder belts are positioned in front of the seat-back, and the centre shoulder belt is re-positioned in the holding slot.

■ Folding the Rear Seat Up

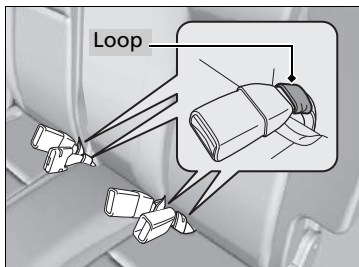

Separately lift up the left and right halves of the rear seat cushions to make room for luggage area.

■ Lifting up the seat cushion

1. Make sure the seat belt buckles are in their loops on the seat.
2. Pull up the rear seat cushion.
3. Fold the seat leg down while pushing the seat cushion firmly against the seat-back to lock it.

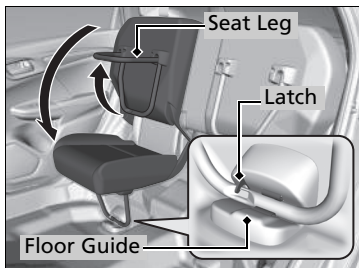
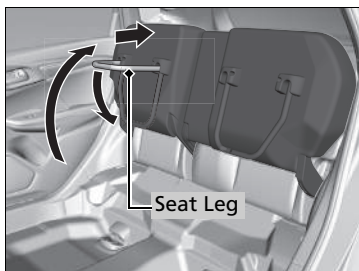

■ Putting the seat in the original position

1. Hold the seat cushion in the upright position, and pull up the seat leg fully.
 - The seat cushion can abruptly fall down once you pull up the seat leg.
2. Slowly put down the seat cushion and set the seat leg in the floor guide.
 - A latch comes out when the leg is set properly.

► Folding the Rear Seat Up

After you fold the seat up, or put it back in the original position, make sure the seat is firmly secured by rocking it forward and back.

Check if there are any items on the seat before you pull the seat cushion up. Check if there are any obstacles around the floor guide before you put the seat back in the original position.

Armrest*

■ Using the Front Seat Armrest

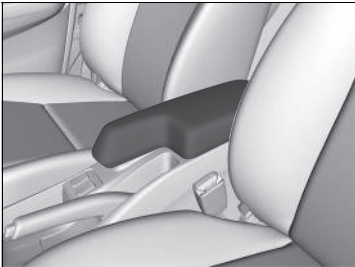

The console lid can be used as an armrest.

* Not available on all models

Interior Lights

Interior Light Switch

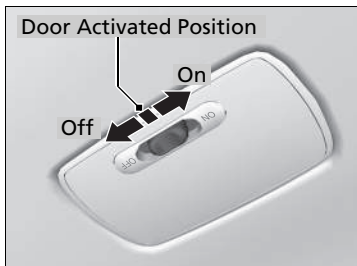

■ ON

The interior light comes on regardless of whether the doors are open or closed.

■ Door activated

The interior light comes on in the following situations:

- When any of the doors are opened.
- You unlock the driver's door.

Models without keyless access system

- You remove the key from the ignition switch.

Models with keyless access system

- When the power mode is set to VEHICLE OFF (LOCK).

Only the luggage area light comes on when the tailgate is opened

■ OFF

The interior light remains off regardless of whether the doors are open or closed.

Interior Light Switch

In the door activated position, the interior light fades out and goes off about 30 seconds after the doors are closed.

The light goes off after 30 seconds in the following situations:

- When you unlock the driver's door but do not open it.

Models without keyless access system

- When you remove the key from the ignition switch but do not open a door.

Models with keyless access system

- When you set the power mode to VEHICLE OFF (LOCK), but do not open a door.

The interior light goes off immediately in the following situations:

- When you lock the driver's door.
- When you turn the ignition switch to ON **II***1.

Models without keyless access system

- When you close the driver's door with the key in the ignition switch.

Models with keyless access system

- When you close the driver's door in ACCESSORY mode.

If you leave any of the doors open in VEHICLE OFF (LOCK) mode, or without the key in the ignition switch, the interior light goes off after about 15 minutes.

*1: Models with the keyless access system have an **ENGINE START/STOP** button instead of an ignition switch.

Map Lights

Models with display audio system

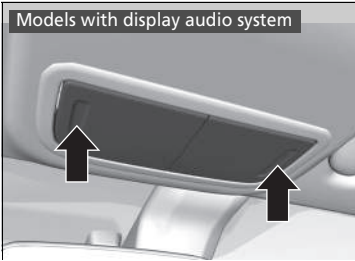

Models with colour audio system

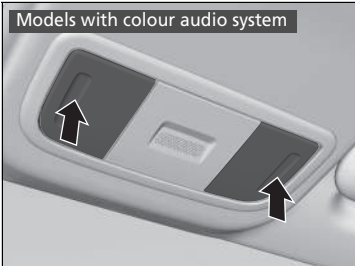

The map lights can be turned on and off by pressing the lenses.

■ Luggage Area Light

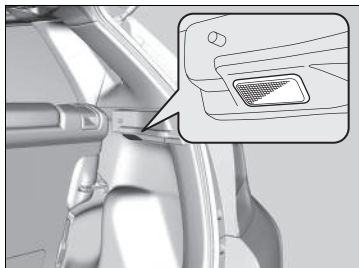

The light comes on when you open the tailgate.

Interior Convenience Items

■ Glove Box

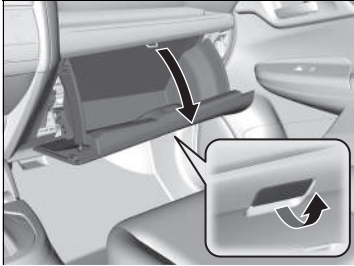

Pull the handle to open the glove box.

■ Console Compartment*

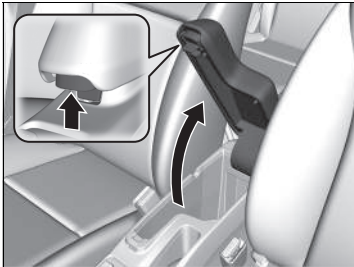

Pull the handle to open the console compartment.

» Glove Box

⚠ WARNING

An open glove box can cause serious injury to your passenger in a crash, even if the passenger is wearing the seat belt.

Always keep the glove box closed while driving.

* Not available on all models

■ Beverage Holders

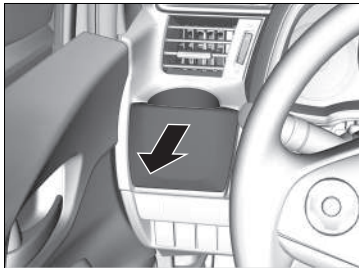

■ Front seat beverage holders

Pull the lid backward to use the front panel beverage holder.

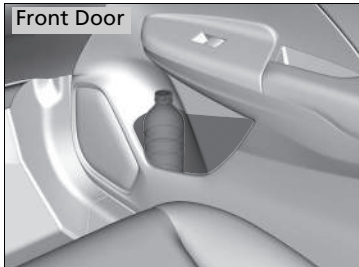
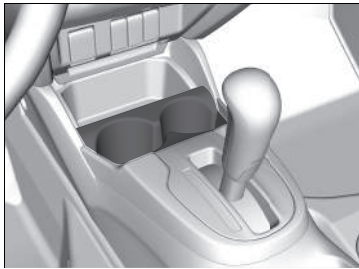

► Beverage Holders

NOTICE

Spilled liquids damage the upholstery, carpeting, and electrical components in the interior.

Be careful when you are using the beverage holders. Hot liquid can scald you.

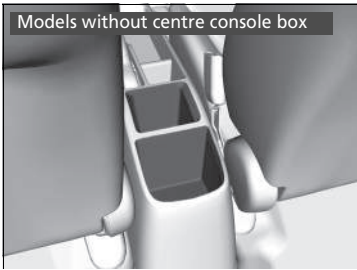

■ Rear seat beverage holders

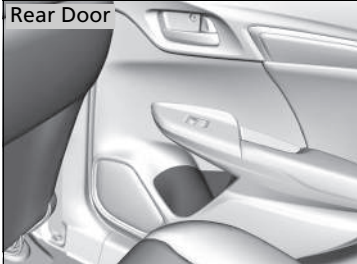

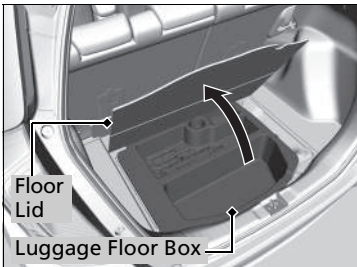

■ Luggage Floor Box

Pull up the luggage area floor lid.



Continued

■ Accessory Power Socket(s)

The accessory power socket can be used when the ignition switch is in ACCESSORY  or ON *1.

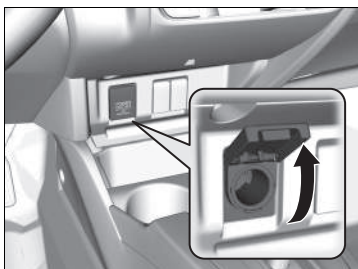

■ Accessory power socket (console panel)

Open the cover to use it.

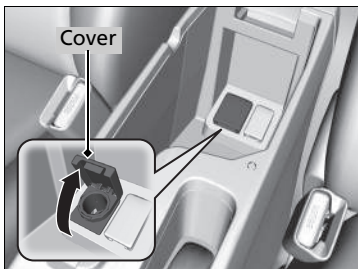

■ Accessory power socket (console compartment)*

Open the console lid and the cover to use it.

▶▶ Accessory Power Socket(s)

NOTICE

Do not insert an automotive type cigarette lighter element.

This can overheat the power socket.

Each accessory power socket is designed to supply power for 12 volt DC accessories that are rated 180 watts or less (15 amps).

To prevent battery drain, only use the power socket with the engine running.

*1 : Models with the keyless access system have an **ENGINE START/STOP** button instead of an ignition switch.

* Not available on all models

■ Coat Hook



There is a coat hook on the rear driver's side grab handle. Pull it down to use it.

■ Tie-down Anchors

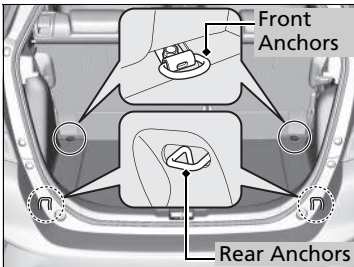

The tie-down anchors on the luggage area floor can be used to install a net for securing items.

☒ Coat Hook

The coat hook is not designed for large or heavy items.

■ Luggage Area Cover*

The luggage area cover may be removed to give you more luggage room.

■ To remove the luggage area cover



1. Open the tailgate.
2. Remove the strap on each side of the tailgate.

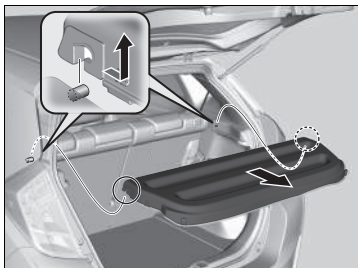

3. Disengage the support rods, then remove the luggage area cover.

Reverse this procedure to install the luggage area cover.

After reinstalling the luggage area cover, make sure it is latched securely.

▣ Luggage Area Cover*

Do not place items on the luggage area cover, or stack objects higher than the top of the back seat. They could block your view and be thrown around the vehicle during a crash or sudden stop.

Do not apply excessive pressure to the cover, such as leaning on it to retrieve an item.

Seat Heaters*



The ignition switch must be in ON **II***1 to use the seat heaters. The **HI** setting heats the seats faster than the **LO** setting.

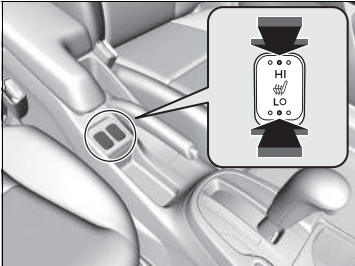

While in **HI**, the heater cycles on and off.

- The appropriate indicator will be on while the seat heater is on. Briefly press the switch on the opposite side to turn the heater off. The indicator will be off. When a comfortable temperature is reached, select **LO** to keep the seat warm.

Seat Heaters*

⚠ WARNING

Heat induced burns are possible when using seat heaters.

Persons with a diminished ability to sense temperature (e.g., persons with diabetes, lower-limb nerve damage, or paralysis) or with sensitive skin should not use seat heaters.

Do not use the seat heaters even in **LO** when the engine is off. Under such conditions, the battery may be weakened, making the engine difficult to start.

In the **LO** setting, the heater runs continuously and does not automatically turn off.

*1: Models with the keyless access system have an **ENGINE START/STOP** button instead of an ignition switch.

* Not available on all models

Using Vents, Heating and A/C

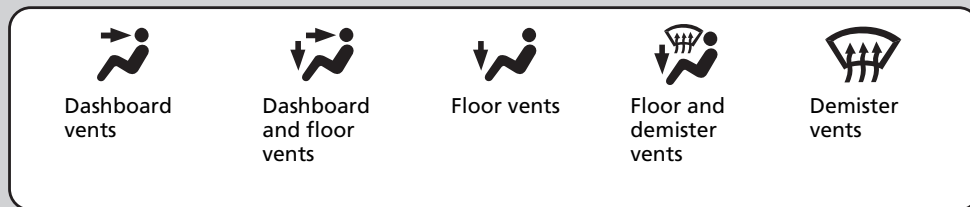

Controls

Fan Control Dial

Adjusts the fan speed. Rotate the dial all the way to **OFF** to turn everything off.

Temperature Control Dial

Adjusts the interior temperature.

Mode Control Dial

Changes airflow.

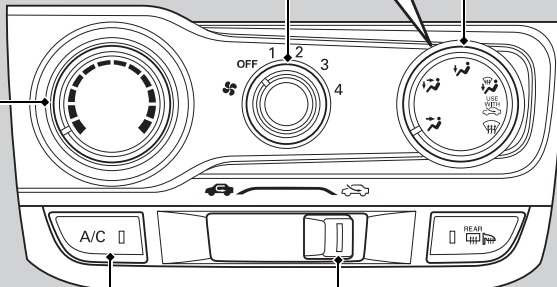

A/C Button

Press to cool the interior or dehumidify while heating.

Fresh Air/Recirculation Lever

This lever controls the source of the air going into the system.



(Recirculation) Mode:
Recirculates air from the vehicle's interior through the system.





(Fresh Air) Mode:
Maintains outside ventilation. Keep the system in fresh air mode in normal situations.

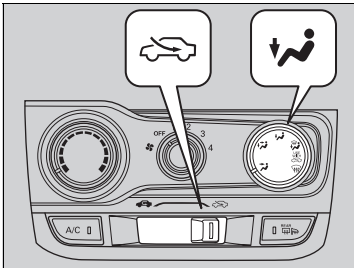

■ Heating



The heater uses heat from the engine coolant to warm the air.



1. Adjust the fan speed using the fan control dial.
2. Select  and .
3. Adjust the temperature using the temperature control dial.

■ To rapidly warm up the interior

1. Set the fan to the maximum speed.
2. Select .
3. Set the temperature to maximum warm.
4. Select .

■ To dehumidify the interior

When used in combination with the heater, the air conditioning system makes the interior warm and dry and can prevent the windows from fogging up.



1. Turn the fan on.
2. Press the **A/C** button to turn on the air conditioning.
3. Select  and . Adjust the temperature to your preference.

☒ To rapidly warm up the interior

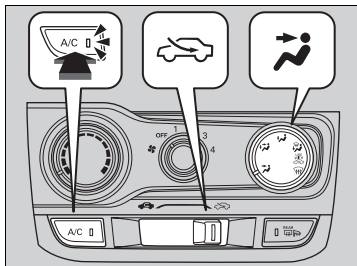

Change to fresh air mode as soon as the interior gets warm enough. The windows may fog up if kept in recirculation mode.

■ Cooling



1. Adjust the fan speed using the fan control dial.
2. Select  and .
3. Adjust the temperature using the temperature control dial.
4. Press the **A/C** button (indicator on).

■ To rapidly cool down the interior

1. Set the fan to the maximum speed.
2. Select .
3. Set the temperature to maximum cool.
4. Press the **A/C** button (indicator on).
5. Select .

►► To rapidly cool down the interior



If the interior is very warm, you can cool it down more rapidly by partially opening the windows.

During the Auto Idle Stop, the air conditioning system will be turned off. To keep the air conditioning on, press  to turn off the Auto Idle Stop system.

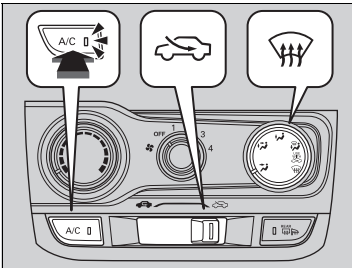

 **Auto Idle Stop System ON/OFF** P. 405, 410

Defrosting the Windscreen and Windows



1. Set the fan to the high speed.
2. Select .
3. Select .
4. Press the **A/C** button (indicator on).

■ To rapidly defrost the windows

1. Set the fan to the maximum speed.
2. Select .
3. Press the **A/C** button (indicator on).
4. Select .
5. Set the temperature to maximum warm.

☒ Defrosting the Windscreen and Windows

For your safety, make sure you have a clear view through all the windows before driving.

Do not set the temperature near the upper or lower limit.

When cold air hits the windscreen, the outside of the windscreen may fog up.

If the side windows fog up, adjust the vents so that the air hits the side windows.

Continuously variable transmission models

Selecting  with the fan on restarts the engine during the Auto Idle Stop activated.

Manual transmission models

To defrost the windscreen during the Auto Idle Stop activated, restart the engine as follows:

1. Make sure the shift lever is in the **N** position.
2. Depress the clutch pedal fully.
3. Select .

☒ To rapidly defrost the windows

After defrosting the windows, switch over to fresh air mode.

If you keep the system in recirculation mode, the windows may fog up from humidity. This impedes visibility.

Using Automatic Climate Control

The automatic climate control system maintains the interior temperature you select. The system also selects the proper mix of heated or cooled air that raises or lowers the interior temperature to your preference as quickly as possible.

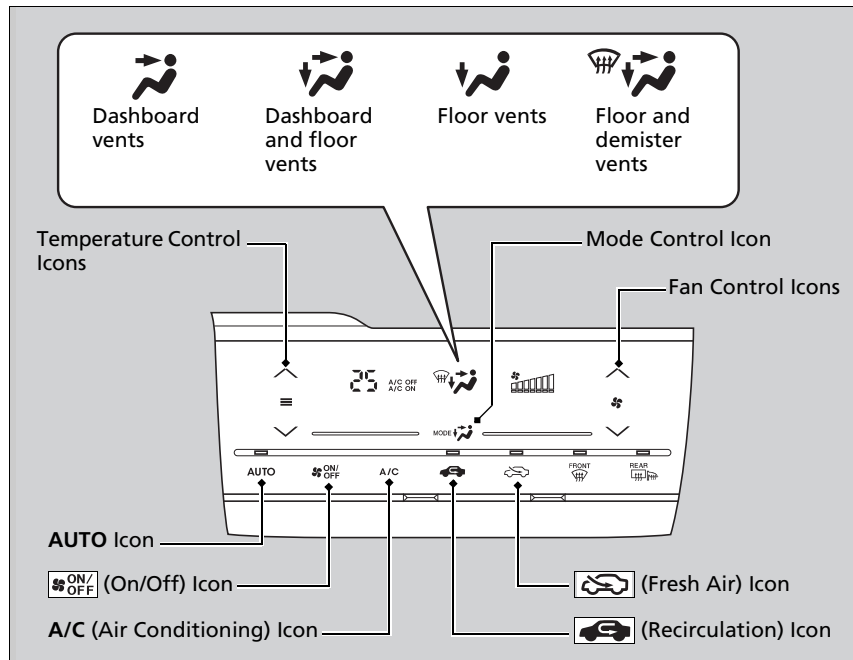

Use the system when the engine is running.

1. Select the **AUTO** icon.
2. Adjust the interior temperature using the temperature control icons.
3. Select the **ON/OFF** icon to cancel.

* Not available on all models

Using Automatic Climate Control

If any icons are selected while using the climate control system in auto, the function of the icon that was selected will take priority. The **AUTO** indicator will go off, but functions unrelated to the icon that was selected will be controlled automatically.

To prevent cold air from blowing in from outside, the fan may not start immediately when the **AUTO** icon is selected.



If the interior is very warm, you can cool it down more rapidly by partially opening the windows, turning the system on auto, and setting the temperature to low. Change the fresh mode to recirculation mode until the temperature cools down.

When you set the temperature to the lower or upper limit, **Lo** or **Hi** is displayed.

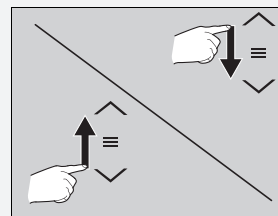
You can raise or lower the temperature or fan speed setting flicking either control icon.



■ Switching between the recirculation and fresh air modes

Select the  or  icon to switch the mode depending on environmental conditions.

 Recirculation mode (indicator on): Recirculates air from the vehicle's interior through the system.

 Fresh air mode (indicator on): Maintains outside ventilation. Keep the system in fresh air mode in normal situations.

☒ Using Automatic Climate Control

Selecting the  icon switches the climate control system between on and off. When turned on, the system returns to your last selection.

During the Auto Idle Stop, the air conditioning system will be turned off.

The air conditioning system may also be turned off when driving uphill.

■ Defrosting the Windscreen and Windows

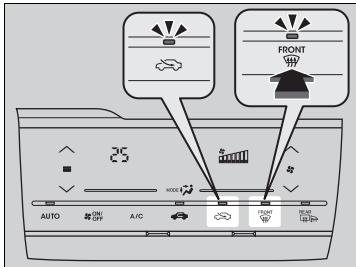

Select the  icon to turn the air conditioning system on and automatically switch the system to fresh air mode.

Select the  icon again to turn off, the system returns to the previous settings.

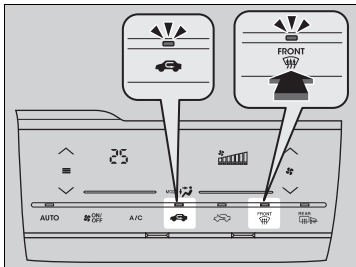

■ To rapidly defrost the windows

1. Select the  icon.
2. Select the  icon.

►► Defrosting the Windscreen and Windows

For your safety, make sure you have a clear view through all the windows before driving.

Do not set the temperature near the upper or lower limit.

When cold air hits the windscreen, the outside of the windscreen may fog up.

If the side windows fog up, adjust the vents so that the air hits the side windows.

Continuously variable transmission models

Selecting  restarts the engine automatically during the Auto Idle Stop.

Manual transmission models

To defrost the windscreen during the Auto Idle Stop activated, restart the engine as follows:

1. Make sure the shift lever is in the **N** position.
2. Depress the clutch pedal fully.
3. Select the  icon.

►► To rapidly defrost the windows



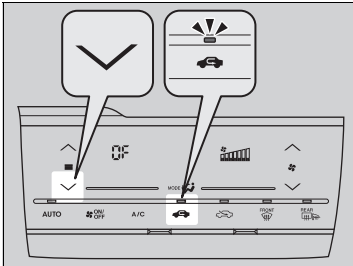

After defrosting the windows, switch over to fresh air mode. If you keep the system in recirculation mode, the windows may fog up from humidity. This impedes visibility.

■ Turning On and Off the Touch Screen Beep

You hear the beep when operating the climate control system on the touch screen. This can be turned on and off.





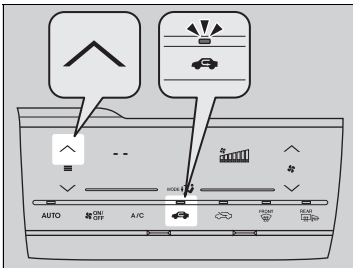

To turn off the beep:

1. Turn the ignition switch to ON *1.
2. Touch the  of the temperature control icon five times while pressing and holding the .
3. Release the , after -- blinks five times and **OF** is displayed.



To turn on the beep:

1. Turn the ignition switch to ON *1.
2. Touch the  of the temperature control icon five times while pressing and holding the .
3. Release the , after **OF** blinks five times and -- is displayed.

☒ Turning On and Off the Touch Screen Beep

If you touch any other icons during this procedure, the setting may fail. In this case, once you turn the ignition switch to LOCK *1, then follow this procedure again.

*1: Models with the keyless access system have an **ENGINE START/STOP** button instead of an ignition switch.

Automatic Climate Control Sensors

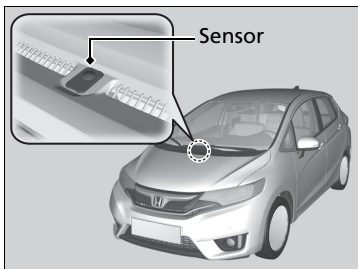

The automatic climate control system is equipped with sensors. Do not cover or spill any liquid on them.

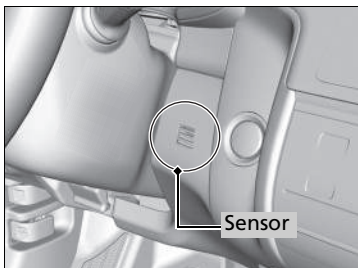

Features

This chapter describes how to operate technology features.

Audio System		
About Your Audio System	214	
USB Port(s)	215	
HDMI™ Port*	216	
Auxiliary Input Jack*	216	
Audio Antenna	217	
Audio System Theft Protection	218	
Audio Remote Controls	219	
Models with colour audio system		
Audio System Basic Operation	221	
Audio/Information Screen	222	
Adjusting the Sound	226	
Display Setup	227	
Playing AM/FM Radio	228	
Playing DAB (Digital Audio Broadcasting)*	235	
Playing a CD	239	
Playing an iPod	242	
Playing a USB Flash Drive	245	
Playing <i>Bluetooth</i> ® Audio	248	
Models with display audio system		
Audio System Basic Operation	251	
Audio/Information Screen	252	
Adjusting the Sound	268	
Display Setup	269	
Playing AM/FM Radio	271	
Playing DAB (Digital Audio Broadcasting)*	276	
Playing a CD	279	
Playing an iPod	282	
Playing a USB Flash Drive	285	
Playing <i>Bluetooth</i> ® Audio	288	
Playing a Video Using the HDMI™	290	
On Board Apps	292	
Smartphone Connection	293	
Wi-Fi Connection	296	
Siri Eyes Free	298	
Audio Error Messages	299	
General Information on the Audio System	302	
Customized Features	307	
Models with colour audio system		
Hands-Free Telephone System	333	
Models with display audio system		
Hands-Free Telephone System	356	

* Not available on all models

About Your Audio System

The audio system features AM/FM radio. It can also play audio CDs, WMA/MP3/AAC files, USB flash drives, and iPod, iPhone and *Bluetooth*[®] devices.

You can operate the audio system from the buttons and switches on the panel, the remote controls on the steering wheel, or the icons on the touchscreen interface*.

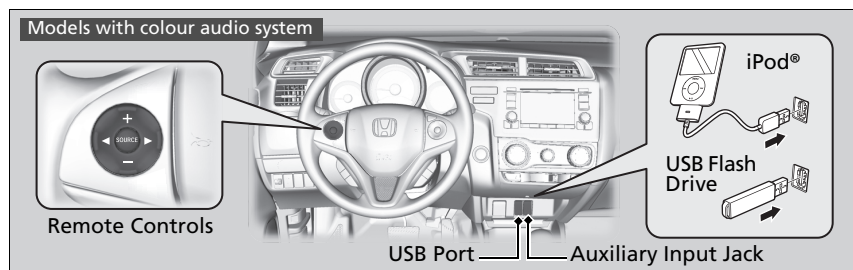
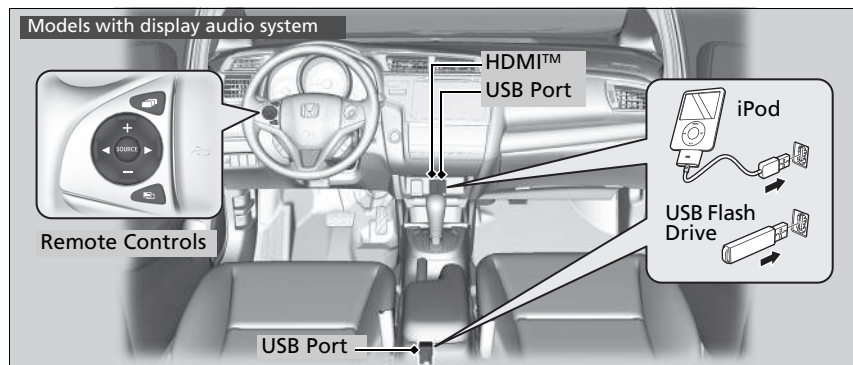

About Your Audio System

Video CDs, DVDs, and 8-cm mini CDs are not supported.

iPod, iPhone and iTunes are trademarks of Apple Inc.

Place your phone where you can get good reception.

Models with display audio system

After you turn the ignition switch to LOCK [0]*¹, you can use the audio system for up to 30 minutes per driving cycle. However, whether you can continue using the audio system depends on the battery condition. Repeatedly using this feature may drain the battery.

*1: Models with the keyless access system have an **ENGINE START/STOP** button instead of an ignition switch.

USB Port(s)

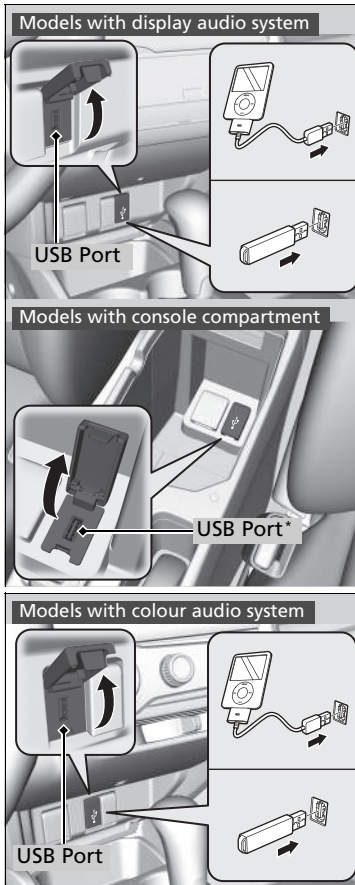

1. Open the cover.
2. Install the iPod dock connector or the USB flash drive to the USB port.

USB Port(s)

- Do not leave the iPod or USB flash drive in the vehicle. Direct sunlight and high temperatures may damage it.
- We recommend using an extension cable with the USB port.
- Do not connect the iPod or USB flash drive using a hub.
- Do not use a device such as a card reader or hard disk drive, as the device or your files may be damaged.
- We recommend backing up your data before using the device in your vehicle.
- Displayed messages may vary depending on the device model and software version.

If the audio system does not recognize the iPod, try reconnecting it a few times or reboot the device. To reboot, follow the manufacturer's instructions provided with the iPod or visit www.apple.com/ipod.

* Not available on all models

HDMI™ Port*

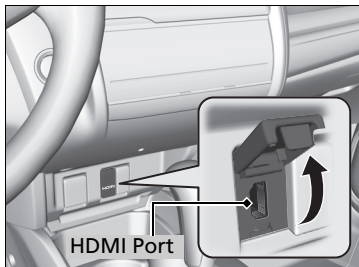

1. Open the cover.
2. Install the HDMI™ cable to the HDMI™ port.

⊗ HDMI™ Port*

- Do not leave the HDMI™ connected device in the vehicle. Direct sunlight and high temperatures may damage it.
- We recommend backing up your data before using the device in your vehicle.
- Displayed messages may vary depending on the device model and software version.

The terms HDMI and HDMI High-Definition Multimedia Interface, and the HDMI Logo are trademarks or registered trademarks of HDMI Licensing LLC in the United States and other countries.

Auxiliary Input Jack*

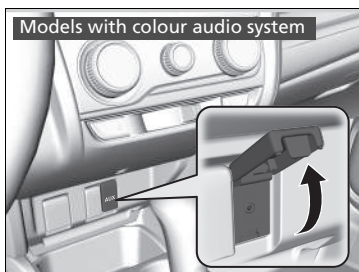

Use the jack to connect standard audio devices.

1. Open the **AUX** cover.
2. Connect a standard audio device to the input jack using a 3.5 mm (1/8 inch) stereo miniplug.
 - ▶ The audio system automatically switches to the AUX mode.

⊗ Auxiliary Input Jack*

To switch the mode, press any of the audio mode buttons. You can return to AUX mode by pressing the **CD/AUX** button.

Audio Antenna

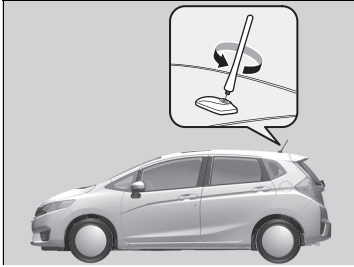

Rear fixed antenna type

Your vehicle is equipped with a removable antenna at the rear of the roof.

▶▶ Audio Antenna

Rear fixed antenna type

NOTICE

Before using a "drive-through" car wash, remove the antenna by unscrewing it by hand. This prevents the antenna from being damaged by the car wash brushes.

Audio System Theft Protection

The audio system is disabled when it is disconnected from the power source, such as when the battery is disconnected or goes dead. In certain conditions, the system may display a pass code input mode. If this occurs, reactivate the audio system.

■ Reactivating the audio system

1. Turn the ignition switch to ON *1.
2. Turn on the audio system.
3. Press and hold the audio system power button for more than two seconds.
 - ▶ The audio system is reactivated when the audio control unit establishes a connection with the vehicle control unit. If the control unit fails to recognise the audio unit, you must go to a dealer and have the audio unit checked.

*1 : Models with the keyless access system have an **ENGINE START/STOP** button instead of an ignition switch.

Audio Remote Controls

Allows you to operate the audio system while driving.

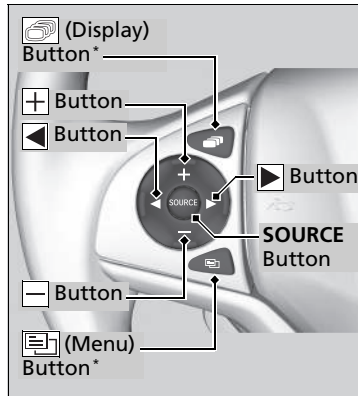

SOURCE Button

Cycles through the audio modes as follows:

Models with colour audio system

FM1→FM2→DAB1*→DAB2*→LW→MW→
CD→USB→iPod→*Bluetooth*® Audio→
AUX

Models with display audio system

FM→LW→MW→DAB*→CD→USB→iPod→
Apps→*Bluetooth*® Audio→AUX HDMI™

(Volume) Buttons

Press : To increase the volume.

Press : To decrease the volume.

< > Buttons

- When listening to the radio
 - Press** : To select the next preset radio station.
 - Press** : To select the previous preset radio station.
 - Press and hold** : To select the next strong station.
To select the next service (DAB*).
 - Press and hold** : To select the previous strong station.
To select the previous service (DAB*).
- When listening to a CD, iPod, USB flash drive, or *Bluetooth*® Audio
 - Press** : To skip to the next song.
 - Press** : To go back to the beginning of the current or previous song.
- When listening to a CD or USB flash drive
 - Press and hold** : To skip to the next folder.
 - Press and hold** : To go back to the previous folder.

* Not available on all models





Continued

Audio Remote Controls

Some mode appears only when an appropriate device or medium is used.

Models with display audio system

Steering Wheel  (Menu) Button

- When listening to the radio
Press : To display the menu items. You can select **Scan**, **Save Preset**, or **Seek**.
- When listening to a CD or USB flash drive
Press : To display the menu items. You can select **Scan**, **Repeat**, or **Random**.
- When listening to an iPod
Press : To display the menu items. You can select **Repeat** or **Shuffle**.
- When listening to a *Bluetooth*[®] Audio
Press : To display the menu items. You can select **Pause** or **Play**.
- When watching a video
Press : To display the menu items. You can select **Scan**, **Repeat**, **Random** or **Play/Pause**.

 **(Display) Button**

Cycles through the displays as follows:

Navigation* → Phone → Audio

▶▶ Audio Remote Controls

The  button is available only when the audio mode is FM, DAB*, LW, MW, CD, USB, iPod, or *Bluetooth*[®] Audio.

Models with colour audio system

To use the audio system function, the ignition switch must be in ACCESSORY **I** or ON **II**.

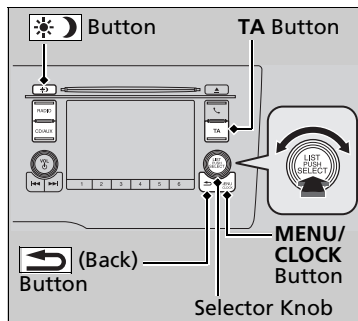

Use the selector knob or **MENU/CLOCK** button to access some audio functions.

Press to switch between the normal and extended display for some functions.

Selector knob: Rotate left or right to scroll through the available choices. Press to set your selection.

MENU/CLOCK button: Press to select any mode.

The available mode includes the wallpaper, display, clock, language setup, sound settings, RDS settings, and play modes. Play modes can be also selected from scan, random, repeat, and so on.

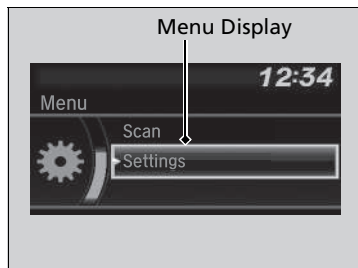

(Back) button: Press to go back to the previous display.

TA button: Press to select the traffic announcement mode.

button: Press to change the audio/information screen brightness.

Press , then adjust the brightness using .

- ▶ Each time you press , the mode switches between the daytime mode, nighttime mode and **OFF** mode.

Audio System Basic Operation

These indications are used to show how to operate the selector knob.

Rotate to select.

Press to enter.

Press the **SOURCE**, , , or button on the steering wheel to change any audio setting.

▶ **Audio Remote Controls** P. 219

Audio Menu Items

▶ **Adjust Clock** P. 139

▶ **Wallpaper Setup** P. 224

▶ **Display Setup** P. 227

▶ **Sound Settings** P. 226

▶ **Scan** P. 241, 247

▶ **Play Mode** P. 241, 244, 247

▶ **RDS Settings** P. 229

▶ **DAB Settings** P. 238

▶ **Bluetooth** P. 248

One of the operating systems used in this unit is eCos.

For software license terms and condition, visit their website (eCos license URL:

<http://ecos.sourceforge.org/license-overview.html>)

For source code disclosure and other details regarding eCos, visit:

<http://www.hondaopensource2.com>

Audio/Information Screen

Displays the audio status and wallpaper. From this screen, you can go to various setup options.

■ Switching the Display

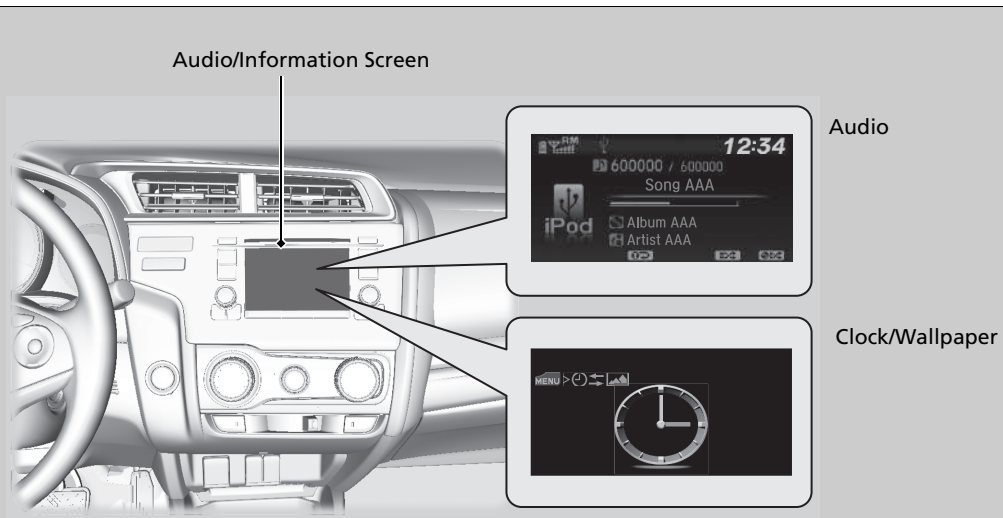







■ Audio

Shows the current audio information.

■ Clock/Wallpaper

Shows a clock screen or an image you import.

■ Change display

1. Press the **MENU/CLOCK** button.
2. Rotate  to select **Settings**, then press .
3. Rotate  to select **Display change**, then press .
4. Rotate  to select **Wallpaper**, then press .
 - ▶ If you want to return to the audio display, select **Audio**.

Wallpaper Setup

You can change, store, and delete the wallpaper on the audio/information screen.

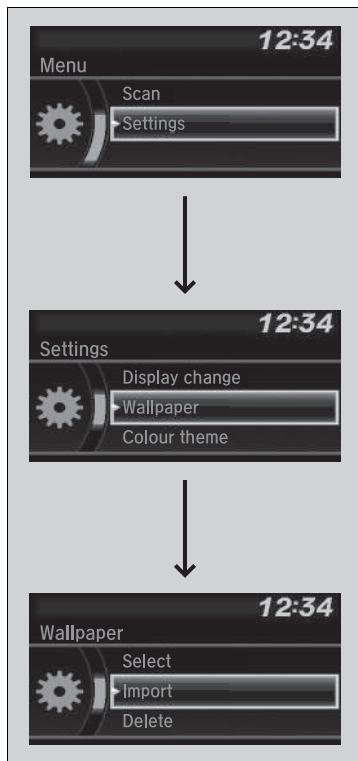

■ Import wallpaper









You can import up to three images, one at a time, for wallpaper from a USB flash drive.

1. Connect the USB flash drive to the USB port.
 ▶ **USB Port(s)** P. 215
2. Press the **MENU/CLOCK** button.
3. Rotate to select **Settings**, then press .
4. Rotate to select **Wallpaper**, then press .
5. Rotate to select **Import**, then press .
 - ▶ The picture name is displayed on the list.
6. Rotate to select a desired picture, then press .
 - ▶ The selected picture is displayed.
7. Press to save the picture.
8. Press to select **OK**.
9. Rotate to select a location to save the picture, then press .
 - ▶ The display will return to the wallpaper setting screen.



▶▶ Wallpaper Setup

- When importing wallpaper files, the image must be in the USB flash drive's root directory. Images in a folder cannot be imported.
- The file name must be fewer than 64 characters.
- The file format of the image that can be imported is BMP (bmp) or JPEG (jpg).
- The individual file size limit is 2 MB.
- The maximum image size is 1,920 x 936 pixels. If the image size is less than 420 x 234 pixels, the image is displayed in the middle of the screen with the extra area appearing in black.
- Up to 255 files can be selected.

■ Select wallpaper

1. Press the **MENU/CLOCK** button.
2. Rotate  to select **Settings**, then press .
3. Rotate  to select **Wallpaper**, then press .
4. Rotate  to select **Select**, then press .
 - ▶ The screen changes to the wallpaper list.
5. Rotate  to select a desired wallpaper, then press .

■ Delete wallpaper

1. Press the **MENU/CLOCK** button.
2. Rotate  to select **Settings**, then press .
3. Rotate  to select **Wallpaper**, then press .
4. Rotate  to select **Delete**, then press .
 - ▶ The screen changes to the wallpaper list.
5. Rotate  to select a wallpaper that you want to delete, then press .
6. Rotate  to select **Yes**, then press .
 - ▶ The display will return to the wallpaper setting screen.

Wallpaper Setup

To go back to the previous screen, press the  (Back) button.

When the file size is large, it takes a while to be previewed.

Adjusting the Sound

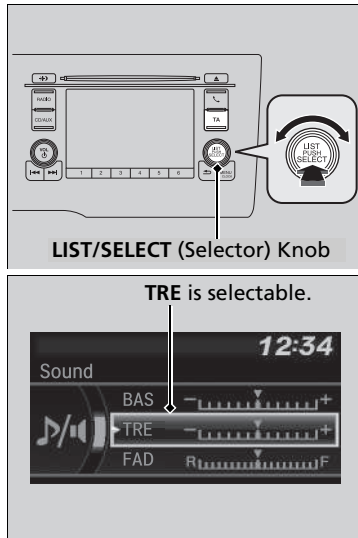

1. Press the **MENU/CLOCK** button.
2. Rotate to select **Sound**, then press .
3. Rotate to scroll through the following choices:

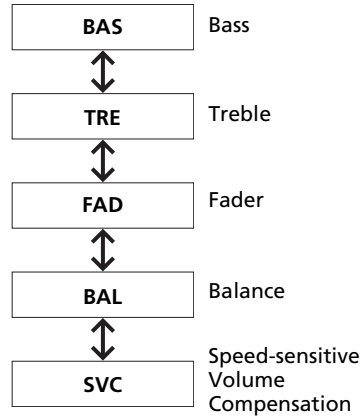

Rotate to adjust the sound setting, then press .

▶▶ Adjusting the Sound

The SVC has four modes: **Off**, **Low**, **Mid**, and **High**. SVC adjusts the volume level based on the vehicle speed. As you go faster, audio volume increases. As you slow down, audio volume decreases.

Display Setup

You can change the brightness or colour theme of the audio/information screen.

Changing the Screen Brightness

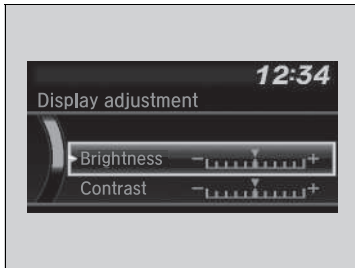

1. Press the **MENU/CLOCK** button.
2. Rotate to select **Settings**, then press .
3. Rotate to select **Display adjustment**, then press .
4. Rotate to select **Brightness**, then press .
5. Rotate to adjust the setting, then press .

Changing the Screen's Colour Theme

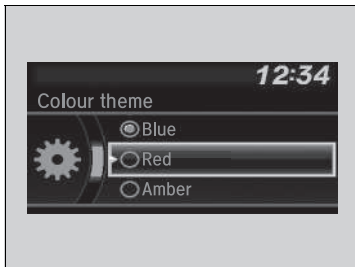

1. Press the **MENU/CLOCK** button.
2. Rotate to select **Settings**, then press .
3. Rotate to select **Colour theme**, then press .
4. Rotate to select the setting you want, then press .

Changing the Screen Brightness

You can change the **Contrast** and **Black level** settings in the same manner.

Playing AM/FM Radio

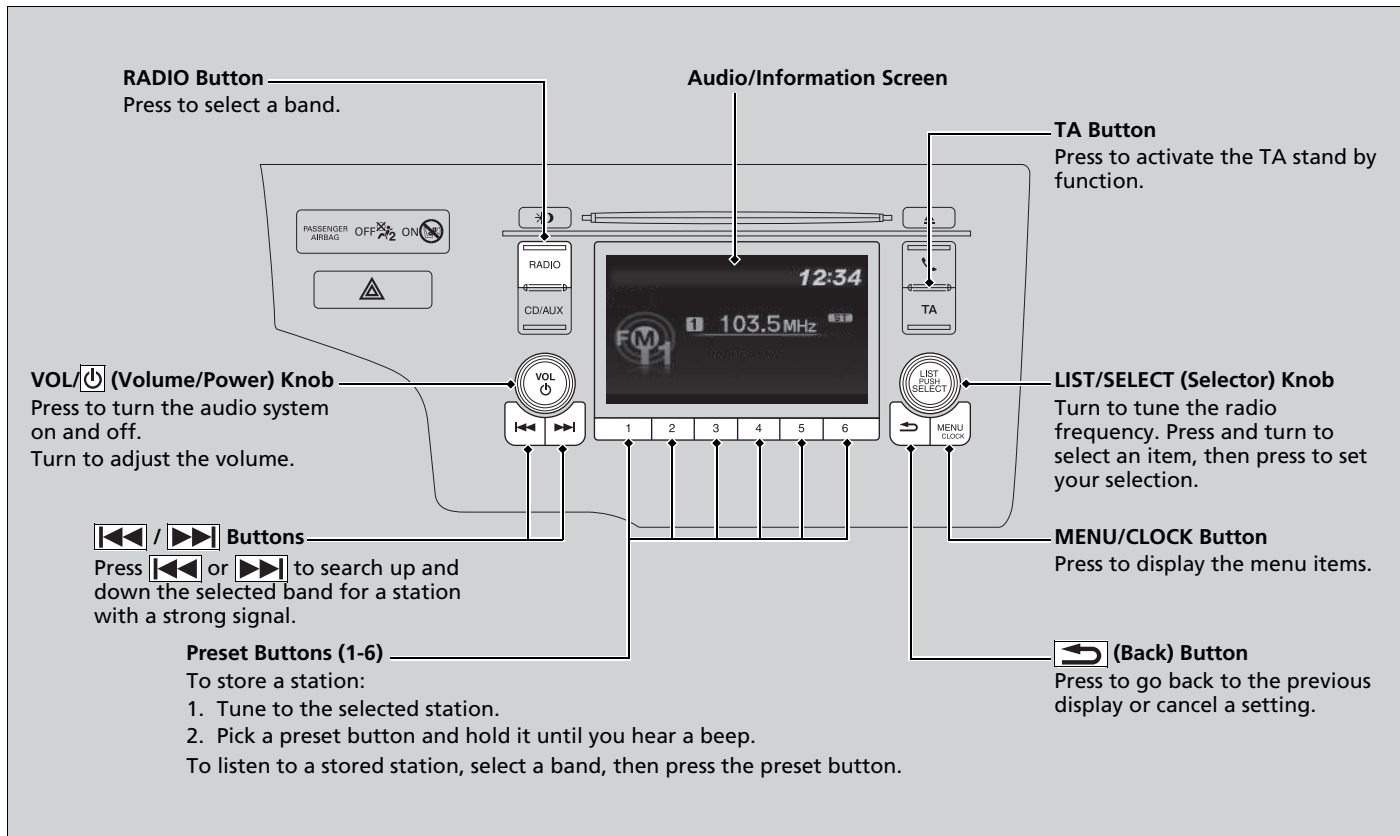

FM mode

■ Radio Data System (RDS)*

Provides convenient automated services related to your selected RDS-capable FM station.

■ To find an RDS station from Station List



1. Press while listening to an FM station.
2. Rotate to select the station, then press .

■ Manual Update

Updates your available station list at any time.

1. Press while listening to an FM station.
2. Rotate to select **Update list**, then press .

▶▶ Playing AM/FM Radio

The **ST** indicator appears on the display indicating stereo FM broadcasts.
Stereo reproduction in AM is not available.

Switching the Audio Mode

Press the **SOURCE** button on the steering wheel.

Audio Remote Controls P. 219

You can store 12 AM stations and 12 FM stations into the preset button memory. AM has two types of frequencies LW and MW, and each lets you store six stations. FM1 and FM2 let you store six stations each.

▶▶ Radio Data System (RDS)*

When you select an RDS-capable FM station, the RDS automatically turns on, and the frequency display changes to the station name. However, when the signals of that station become weak, the display changes from the station name to the frequency.

■ Available RDS functions

Alternative Frequency (AF):

Automatically changes the frequency of the same programme as you enter different regions.

Regional Programme (REG):



Keeps the same frequency of the stations within that region even if the signal gets weak.

Except AM/FM/DAB* mode

News Programme (NEWS):

Automatically tunes to the news programme.

⊞ Radio Data System (RDS)*

While listening to an FM station on **Station list**, pressing  /  (Seek/Skip) button changes the station.

■ Selecting the RDS functions

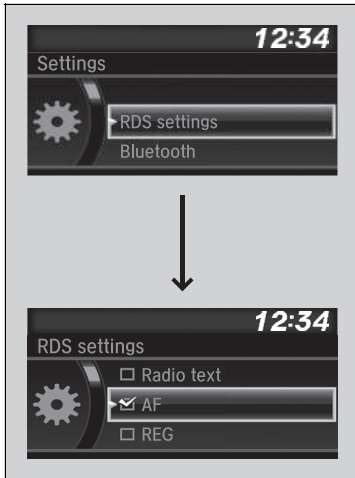

1. Press the **MENU/CLOCK** button with the FM selected.
2. Rotate to select **RDS settings** and press .
3. Each RDS function is displayed every time you rotate .
4. Press to select a function.

▶▶ Radio Data System (RDS)*

Turning the Alternative Frequency (AF) function on and off turns the RDS on and off.

Pressing switches the function between on and off.

* Not available on all models

■ Traffic announcement (TA) button

TA standby function allows the system to stand by for traffic announcements in any mode. The last tuned station must be an RDS-capable traffic programme station.

To turn the function on: Press the **TA** button. When a traffic announcement begins on your last tuned station, the system automatically switches to the FM mode. **TA-INFO** appears on the display. The system returns to your last selected mode after the traffic announcement is finished.

If you want to go back to your last selected mode during the traffic announcement, press the **TA** button again.

To cancel the function: Press the **TA** button.

Except AM/FM/DAB* mode

■ Programme type (PTY)/News interrupt function

Allows the system to interrupt with a newscast in any mode. The last tuned station must be the NEWS PTY coded station.

To activate the function: Select **NEWS** from **RDS settings** and display the NEWS PTY before changing to other modes. When a newscast begins on your last tuned station, the system automatically switches to the FM mode.

▶ **Selecting the RDS functions** P. 231

The system returns to your last selected mode if changed to another programme, or signal gets weak.

▶▶ Radio Data System (RDS)*

TA

When you press the **TA** button, the **TA** indicator appears on the display.

If you select **SCAN** while the TA standby function is on, the system searches TP station only.



Pressing the **TA** button while the traffic announcement is on does not cancel the TA standby function.

■ PTY alarm

When the PTY code for emergency announcements, such as natural disasters, is received, **ALARM** appears on the display and the system interrupts your audio operation.

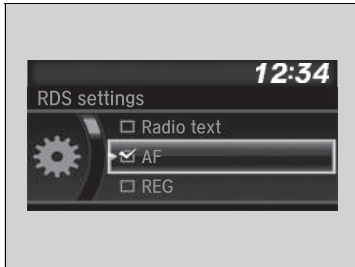
■ Radio Text



1. Press the **MENU/CLOCK** button with the FM selected.
2. Rotate  to select **Radio text** and press .

▶▶ Radio Text



The **TEXT** indicator appears on the display indicating radio text information.

Continued

AM (MW/LW) mode



Station List

Lists the strongest stations on the selected band.

1. Press the **RADIO** button to switch to a mode.
2. Press  to switch to the station list mode.
3. Rotate  to select the station, then press .

Manual update

Updates your available station list at any time.

1. Press the **RADIO** button to switch to a mode.
2. Press  to switch to the station list mode.
3. Rotate  to select **Update list**, then press .



Scan

Samples each of the strongest stations on the selected band for 10 seconds.

1. Press the **MENU/CLOCK** button.
2. Rotate  to select **Scan**, then press .

To turn off scan, press .

Station List

If the system cannot find any station on **Station list**, a confirmation message for updating the list appears. Rotate  to select **Yes**, then press  to update the list.

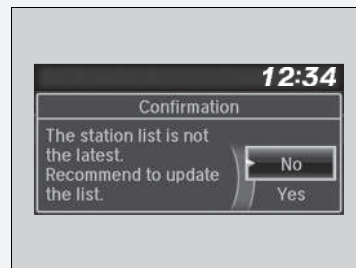



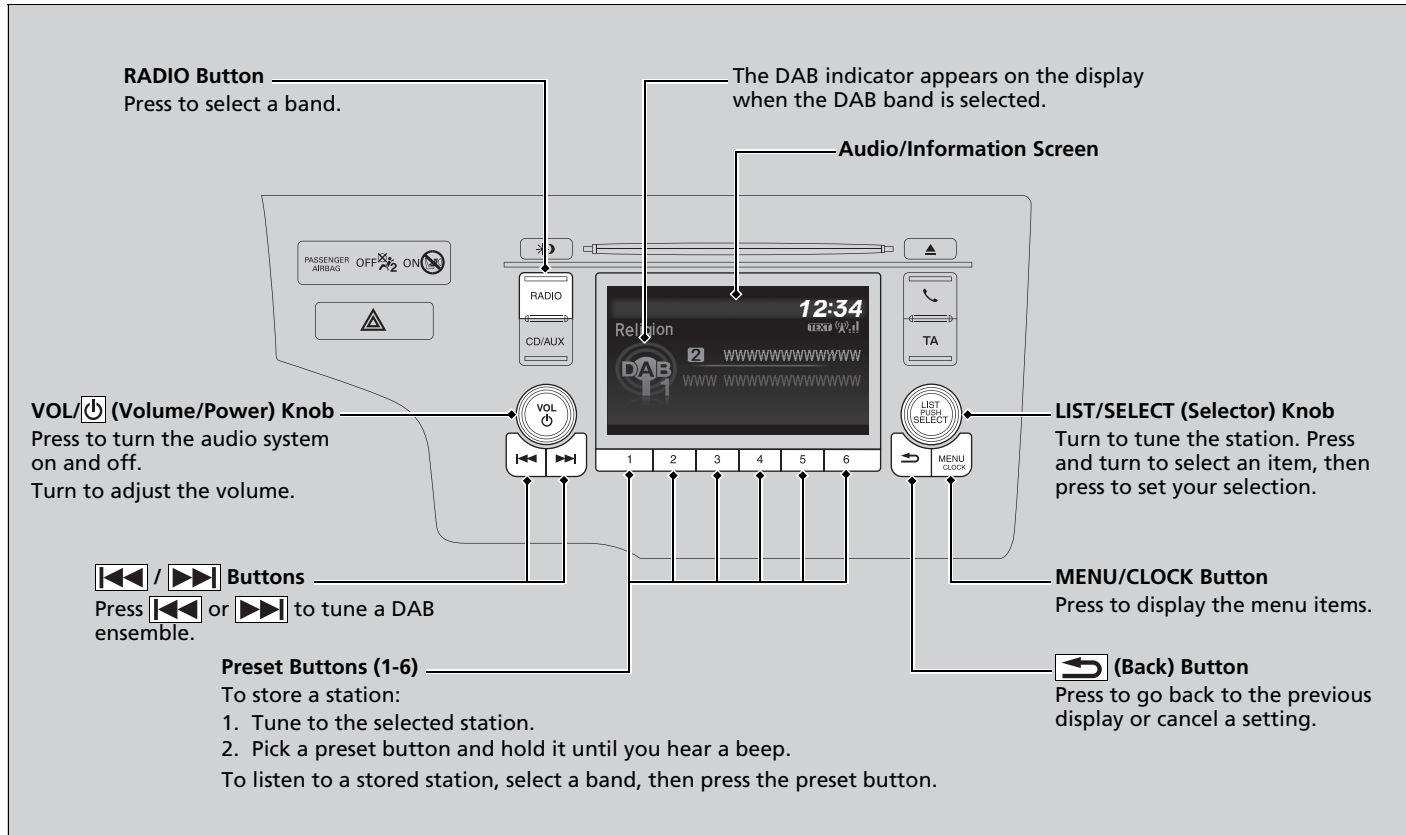

Playing DAB (Digital Audio Broadcasting)*



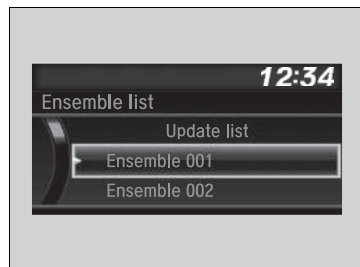

* Not available on all models

■ To find a DAB station from Service List or Ensemble List



1. Press  while selecting the DAB mode.
 2. Rotate  to select the station, then press .
- ▶ If you select **Update list**, the system updates the station list.





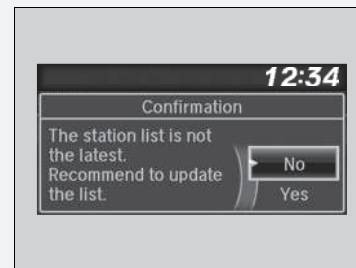

▶▶ To find a DAB station from Service List or Ensemble List

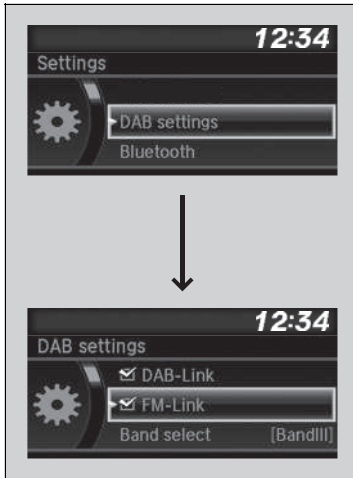
If the system cannot find a station, a confirmation message for updating the list appears. Rotate  to select **Yes**, then press  to update the list.



■ Setting the DAB functions



1. Press the **MENU/CLOCK** button with the DAB selected.
2. Rotate  to select **DAB settings** and press .
3. Each DAB function is displayed every time you rotate .
4. Press  to select a function.
5. Rotate  to select a setting, then press .

■ DAB Settings

■ DAB-Link:

Automatically searches for the same station from Ensembles, and switches to it.

■ FM-Link:



If the system finds the same station from an FM band, it automatically switches the band.

■ Band select:

You can select specific bands. This can reduce the time to update the lists, and search for a station.

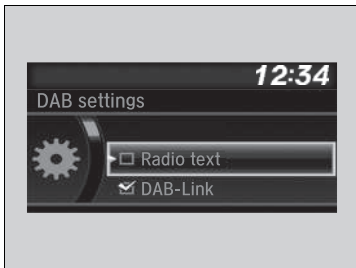
■ Radio Text



1. Press the **MENU/CLOCK** button with the DAB selected.
2. Rotate  to select **Radio text** and press .

☒ Radio Text

The **TEXT** indicator appears on the display indicating radio text information.

Playing a CD

Your audio system supports audio CDs, CD-Rs and CD-RWs in either MP3, WMA, or AAC*1 format. With the CD loaded, press the **CD/AUX** button.

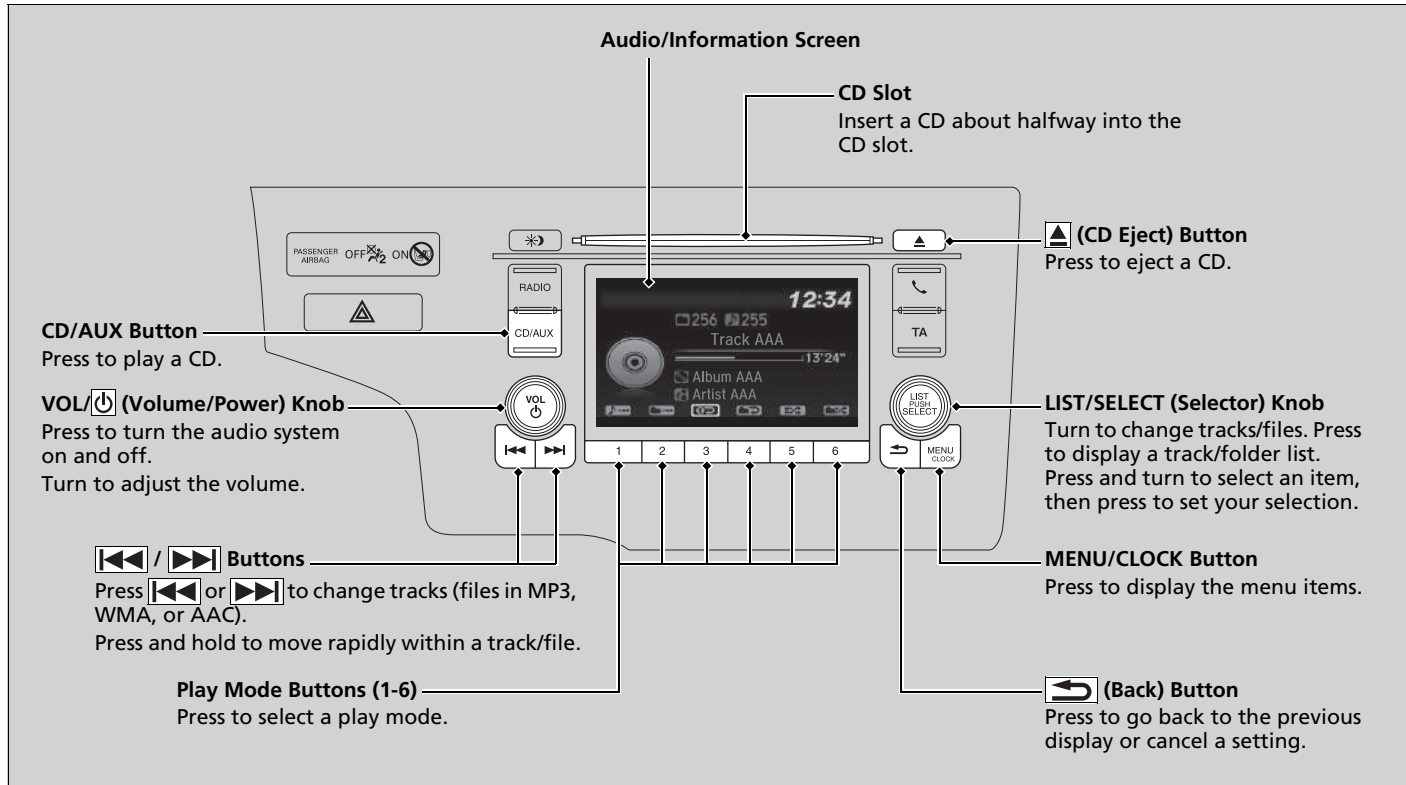

*1: Only AAC format files recorded with iTunes are playable on this unit.

How to Select a File from a Folder with the Selector Knob (MP3/WMA/AAC)

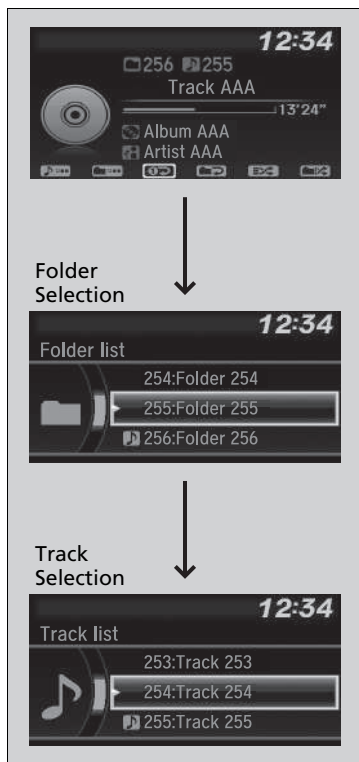

1. Press to switch the display to a folder list.

2. Rotate to select a folder.

3. Press to display a list of files in that folder.

4. Rotate to select a track, then press .

▶▶ Playing a CD

NOTICE

Do not use CDs with adhesive labels. The label can cause the CD to jam in the unit.

WMA files protected by digital rights management (DRM) cannot be played.

The audio system displays **Unplayable file**, then skips to the next file.

Text data appears on the display under the following circumstances:

- When you select a new folder, file, or track.
- When you change the audio mode to CD.
- When you insert a CD.

If you eject the CD but do not remove it from the slot, the system reloads the CD automatically after several seconds.

How to Select a Play Mode

You can select repeat, random, and scan modes when playing a track or file.

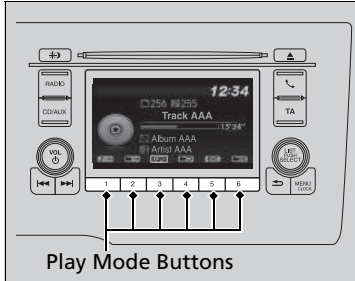

Available mode icons appear above the play mode buttons.

Press the button corresponding to the mode you want to select.

To turn off a play mode

Press the selected button.

How to Select a Play Mode

Play Mode Menu Items

Repeat

 **Repeat one folder** (MP3/WMA/AAC): Repeats all files in the current folder.

 **Repeat one track**: Repeats the current track/file.

Random

 **Random in folder** (MP3/WMA/AAC): Plays all files in the current folder in random order.

 **Random all**: Plays all tracks/files in random order.



Scan



 **Scan folders** (MP3/WMA/AAC): Provides 10-second sampling of the first file in each of the main folders.

 **Scan tracks**: Provides 10-second sampling of all tracks on the CD (all files in the current folder in MP3, WMA, or AAC).

You can also select a play mode by pressing the **MENU/CLOCK** button.

Rotate  to select **Play mode**, then press .

Rotate  to select a mode, then press .

To turn it off, rotate  to select **Normal play**, then press .

Playing an iPod

Connect the iPod using your dock connector to the USB port, then press the **CD/AUX** button.

➤ **USB Port(s)** P. 215

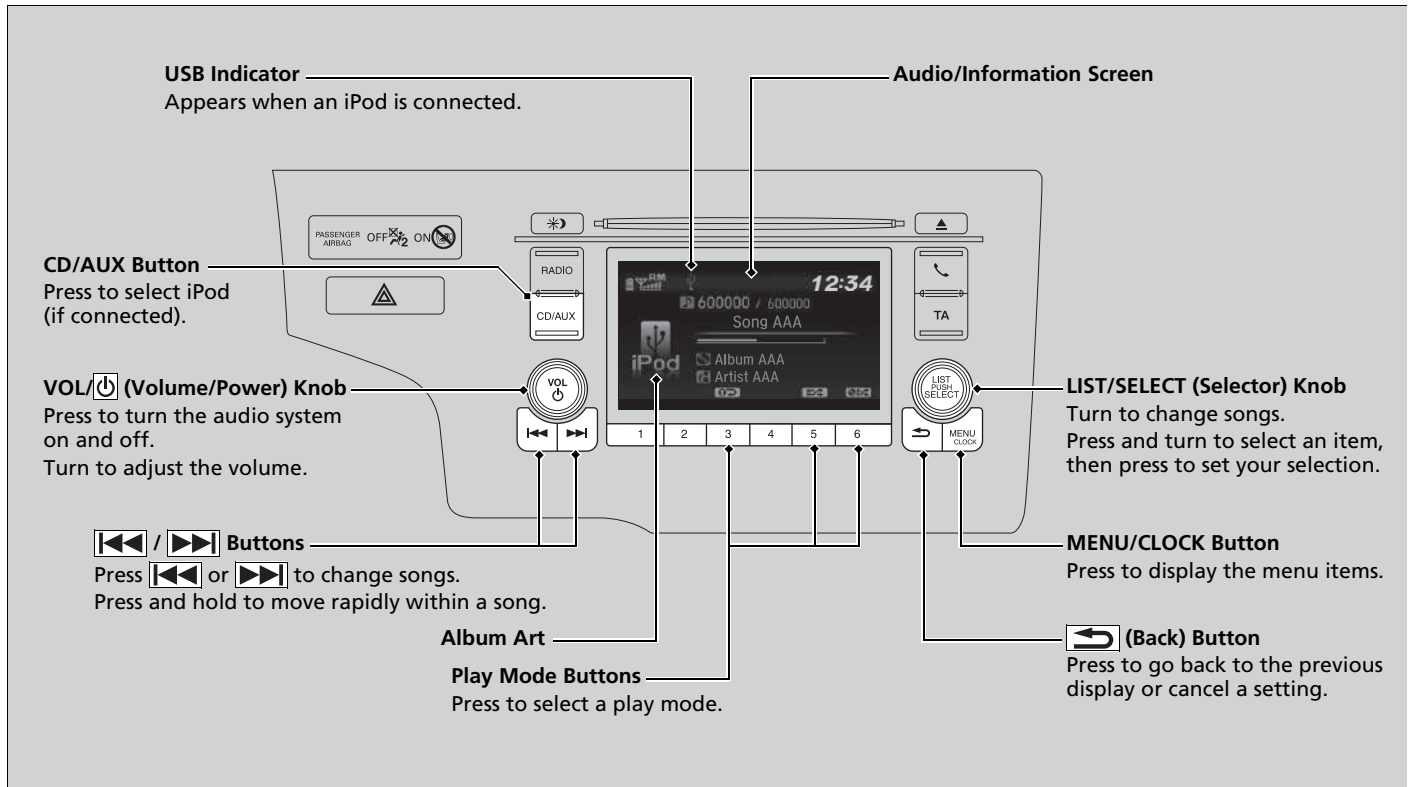

How to Select a Song from the iPod Music List with the Selector Knob

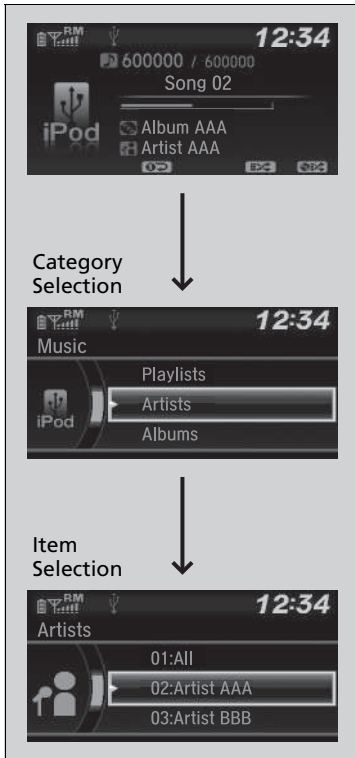

1. Press to display the iPod music list.

2. Rotate to select a category.

3. Press to display a list of items in the category.

4. Rotate to select an item, then press .
▶ Press and rotate repeatedly until a desired item you want to listen is displayed.

▶▶ Playing an iPod

Available operating functions vary on models or versions. Some functions may not be available on the vehicle's audio system.

If there is a problem, you may see an error message on the audio/information screen.

iPod/USB Flash Drive P. 300

Continued

■ How to Select a Play Mode

You can select repeat and shuffle modes when playing a song.

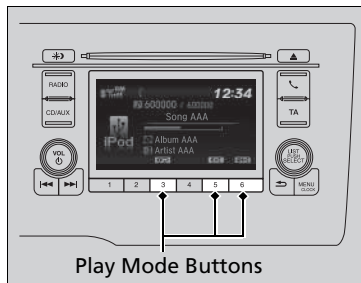

Available mode icons appear above the play mode buttons.

Press the button corresponding to the mode you want to select.

■ To turn off a play mode

Press the selected button.

▶▶ How to Select a Play Mode

Play Mode Menu Items



 **Shuffle albums:** Plays all available albums in a selected category (playlists, artists, albums, songs, genres, or composers) in random order.



 **Shuffle all:** Plays all available songs in a selected category (playlists, artists, albums, songs, genres, or composers) in random order.

 **Repeat one track:** Repeats the current song.

You can also select a play mode by pressing the **MENU/CLOCK** button.

Rotate  to select **Play mode**, then press .

Rotate  to select a mode, then press .

To turn it off, rotate  to select **Normal play**, then press .

Playing a USB Flash Drive

Your audio system reads and plays sound files on a USB flash drive in either MP3, WMA or AAC*1 format.

Connect your USB flash drive to the USB port, then press the **CD/AUX** button.

📌 **USB Port(s)** P. 215

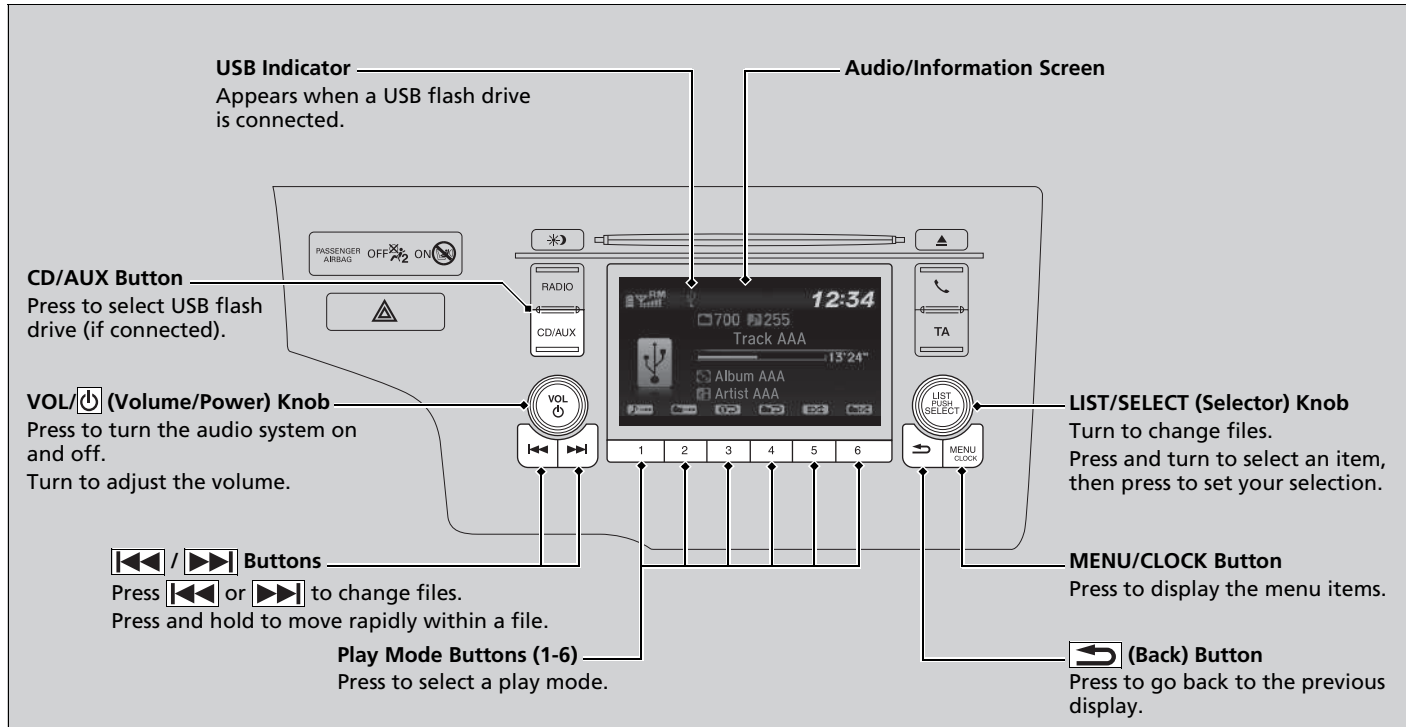

*1: Only AAC format files recorded with iTunes are playable on this unit.

How to Select a File from a Folder with the Selector Knob

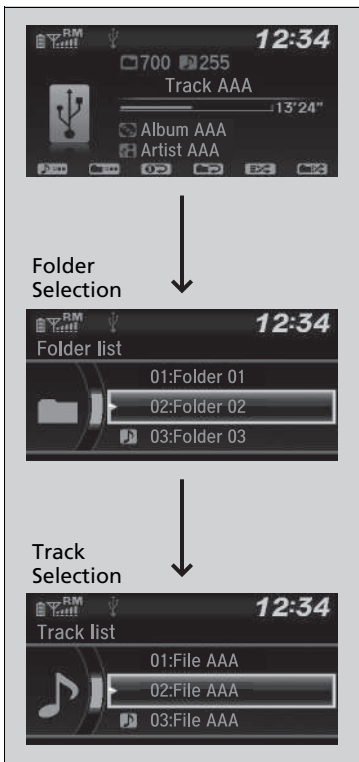

1. Press to display a folder list.
2. Rotate to select a folder.
3. Press to display a list of files in that folder.
4. Rotate to select a file, then press .

▶▶ Playing a USB Flash Drive

Use the recommended USB flash drives.
▶ **General Information on the Audio System**
P. 305

Files in WMA format protected by digital rights management (DRM) cannot be played. The audio system displays **Unplayable file**, and then skips to the next file.

If there is a problem, you may see an error message on the audio/information screen.
▶ **iPod/USB Flash Drive** P. 300

How to Select a Play Mode

You can select repeat, random, and scan modes when playing a file.

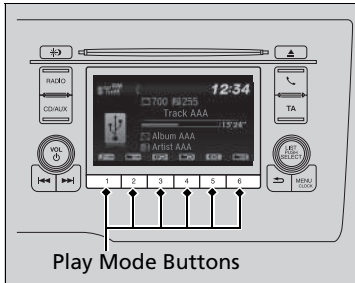

Available mode icons appear above the play mode buttons.

Press the button corresponding to the mode you want to select.

To turn off a play mode

Press the selected button.

How to Select a Play Mode

Play Mode Menu Items

Repeat

Repeat one folder: Repeats all files in the current folder.

Repeat one track: Repeats the current file.

Random

Random in folder: Plays all files in the current folder in random order.

Random all: Plays all files in random order.

Scan

Scan folders: Provides 10-second sampling of the first file in each of the main folders.

Scan tracks: Provides 10-second sampling of all files in the current folder.

You can also select a play mode by pressing the **MENU/CLOCK** button.

Rotate to select **Play mode**, then press .

Rotate to select a mode, then press .

To turn it off, rotate to select **Normal play**, then press .

Playing *Bluetooth*® Audio

Your audio system allows you to listen to music from your *Bluetooth*-compatible phone.

This function is available when the phone is paired and connected to the vehicle's Hands-Free Telephone (HFT) system.

📄 **Phone Setup** P. 340

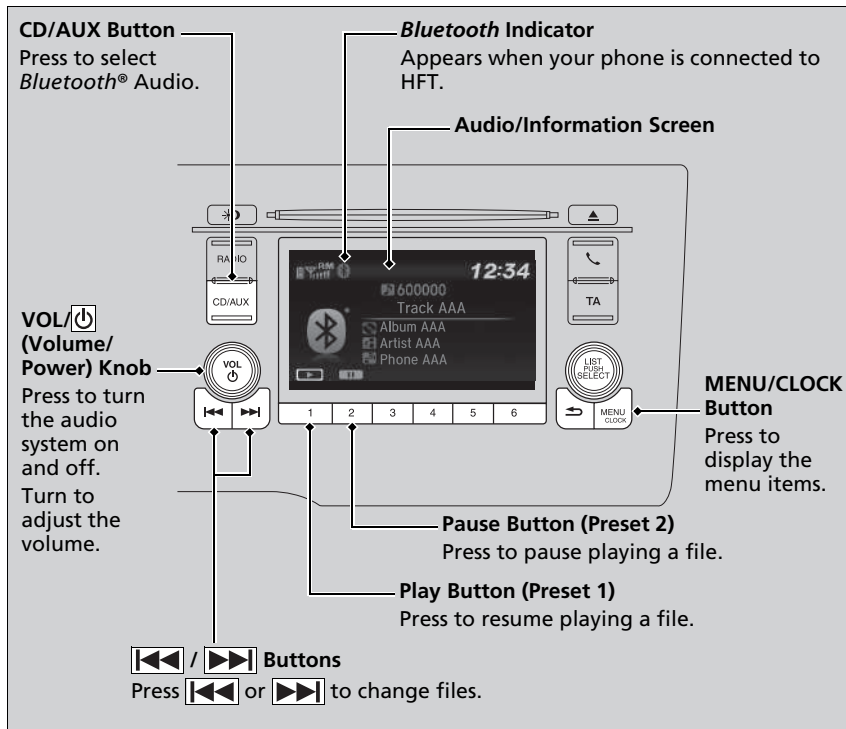

▶▶ Playing *Bluetooth*® Audio

Not all *Bluetooth*-enabled phones with streaming audio capabilities are compatible with the system. To check if your phone is compatible, ask a dealer.

In some countries, it may be illegal to perform some data device functions while driving.

Only one phone can be used with HFT at a time. When there are more than two paired phones in the vehicle, the first paired phone the system finds is automatically connected.

If more than one phone is paired to the system, there will be a delay before the system begins to play.

In some cases, the name of the artist, album, or track may not appear correctly.

Some functions may not be available on some devices.

■ To Play *Bluetooth*® Audio Files

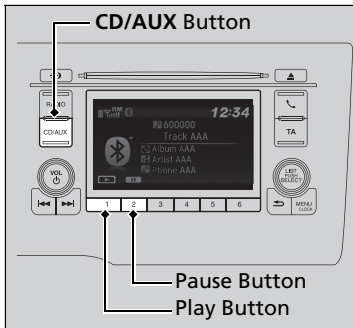

1. Make sure that your phone is paired and connected to the system.
2. Press the **CD/AUX** button.

If the phone is not recognized, another HFT-compatible phone, which is not compatible for *Bluetooth*® Audio, may already be connected.

■ To pause or resume a file

Press a **Play** or **Pause** button to select a mode.

▶▶ To Play *Bluetooth*® Audio Files

To play the audio files, you may need to operate your phone. If so, follow the phone maker's operating instructions.

The pause function may not be available on some phones.

If any audio device is connected to the auxiliary input jack or USB port, you may need to press the **CD/AUX** button repeatedly to select the *Bluetooth*® Audio system.

Switching to another mode pauses the music playing from your phone.

How to Select a Song from the Music Search List with the Selector Knob

▶▶ How to Select a Song from the Music Search List with the Selector Knob

Depending on the *Bluetooth*® device you connect, some or all of the categories may not be displayed.



1. Press to display the music search list.

Category Selection

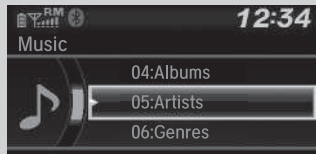

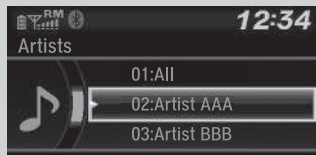

- 2. Rotate to select a category.
- 3. Press to display a list of items in the category.

Item Selection



- 4. Rotate to select an item, then press .
- ▶ Press and rotate repeatedly until a desired item you want to listen is displayed.

Models with display audio system

To use the audio system function, the ignition switch must be in ACCESSORY  or ON *1.

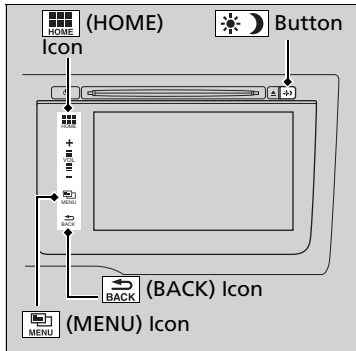



: Select to go to the **HOME** screen.

: **Switching the Display** P. 252



: Touch to select any mode.

The available mode includes **Change Source, Station List, Save Preset, Radio Text, Music Search**, and play modes. Play modes can be also selected from **Scan, Random/Repeat**, and so on.

: Select to go back to the previous display when it is displayed.

 **button**:

Press to change the audio/information screen brightness.

Press  once and select  or  to make an adjustment.

▶ Each time you press , the mode switches between the daytime mode, nighttime mode and **OFF** mode.

Audio System Basic Operation

Audio Menu Items

 **Station List** P. 273

 **Music Search** P. 280, 283, 286

 **Random/Repeat** P. 281, 287

 **Scan** P. 273, 281, 287

When the battery has been reconnected or replaced, the next start-up may take a few minutes for the audio system to start. Wait a few moments while the system is starting up.

Press and hold the  (Power) button for approximately 10 seconds to reset the system. When the system is reset and started up, you are required to input the password.

 **Audio System Theft Protection** P. 218

*1: Models with the keyless access system have an **ENGINE START/STOP** button instead of an ignition switch.

Audio/Information Screen

Displays the audio status and wallpaper. From this screen, you can go to various setup options.

■ Switching the Display

Using the  button

Press the  (display) button on the steering wheel to change the display.

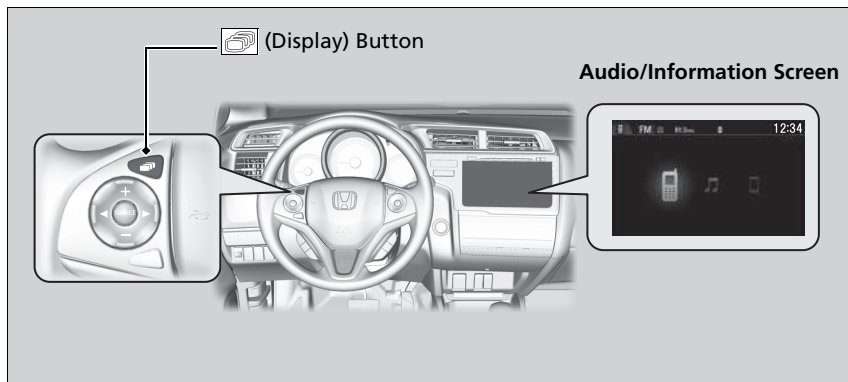

Using the HOME screen

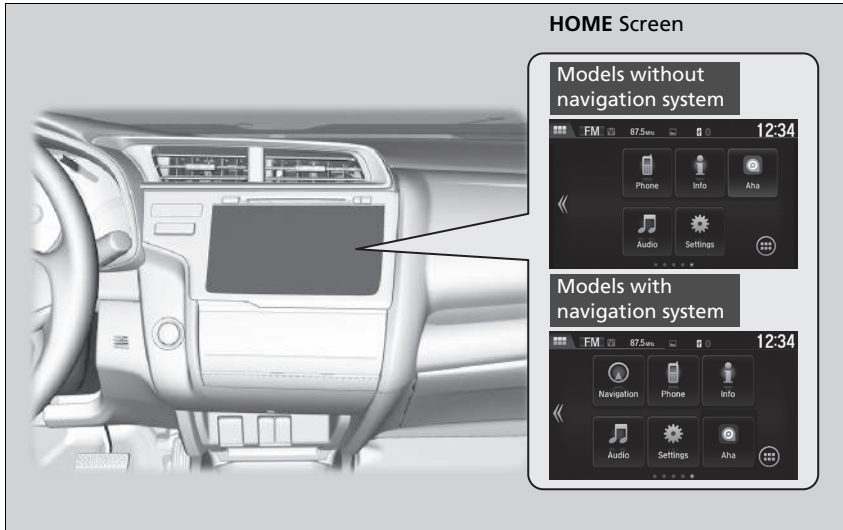

Select **HOME** to go to the **HOME** screen.
 Select **Phone**, **Info**, **Audio**, **Settings** or **Navigation***.

■ Phone

Shows the HFT information.

📞 **Hands-Free Telephone System** P. 356

* Not available on all models

■ Info

To see all available information, **Trip Computer**, **Clock/Wallpaper**, or **System/Device Information**, select **MENU**.

Trip Computer:

- **Current Drive** tab: Displays the current trip information.
- **History of Trip A** tab: Displays information for the three previous drives. The information is stored every time you reset Trip A.

Clock/Wallpaper: Displays the clock and wallpaper.

System/Device Information:

- **Version Information:** Displays the software version of the audio system.
- **USB Device Information:** Displays the memory usage of the USB device.
- **USB Device Change:** Connects or disconnects USB device to this audio system.

■ Audio

Shows the current audio information.

■ Settings

Enters the customizing menu screen.

- **Customized Features** P. 316

■ Navigation*

Displays the navigation screen.

- **Refer to the Navigation System Manual**

Changing the Home Screen Icon Layout



1. Select **HOME**.
2. Select **Settings**.
3. Select **System**.
4. Select the **HOME** tab.
5. Select **Home icon position**.
6. Select and hold the icon then, drag it to the desired position.

■ Wallpaper Setup

You can change, store, and delete the wallpaper on the audio/information screen.

■ Import wallpaper

You can import up to five images, one at a time, for wallpaper from a USB flash drive.

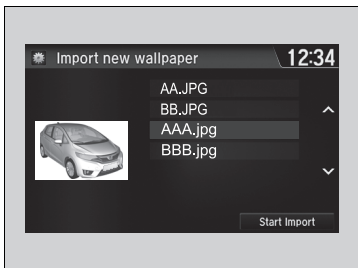
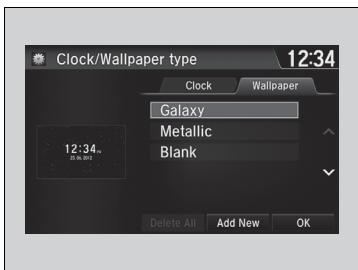

1. Connect the USB flash drive to the USB port.

▶ **USB Port(s)** P. 215

2. Select **Settings** to go to the **Settings** screen.

3. Select **Info**.

4. Select **Clock/Wallpaper Type**, then the **Wallpaper** tab.

5. Select **Add New**.

▶ The picture name is displayed on the list.

6. Select a desired picture.

▶ The preview is displayed on the left side on the screen.

7. Select **Start Import** to save the data.

▶ Then the display will return to the wallpaper list.

▶▶ Wallpaper Setup

- When importing wallpaper files, the image must be in the USB flash drive's root directory. Images in a folder cannot be imported.
- The file name must be fewer than 64 characters.
- The file format of the image that can be imported is BMP (bmp) or JPEG (jpg).
- The individual file size limit is 5 MB.
- The maximum image size is 4,096 × 4,096 pixels. If the image size is less than 800 × 480 pixels, the image is displayed in the middle of the screen with the extra area appearing in black.
- Up to 5 files can be selected.
- If the USB flash drive does not have any pictures, the **No files detected** message appears.

■ Select wallpaper

1. Select **Settings** to go to the **Settings** screen.
2. Select **Info**.
3. Select **Clock/Wallpaper Type**, then the **Wallpaper** tab.
 - ▶ The screen changes to the wallpaper list.
4. Select a desired wallpaper.
 - ▶ The preview is displayed on the left side on the screen.
 - ▶ The pop-up menu appears on the screen.
5. Select **Set**.
 - ▶ The display will return to the wallpaper list.

■ Delete wallpaper

1. Select **Settings** to go to the **Settings** screen.
2. Select **Info**.
3. Select **Clock/Wallpaper Type**, then the **Wallpaper** tab.
 - ▶ The screen changes to the wallpaper list.
4. Select a wallpaper that you want to delete.
 - ▶ The preview is displayed on the left side on the screen.
 - ▶ The pop-up menu appears on the screen.
5. Select **Delete**.
 - ▶ The confirmation message will appear.
6. Select **Yes** to delete completely.
 - ▶ The display will return to the wallpaper list.

Wallpaper Setup

From the pop-up menu, select **Preview** to see a preview at full-size screen.

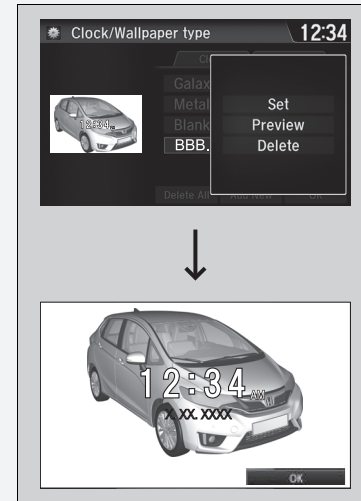

To go back to the previous screen, select **OK**, or **BACK**.



When the file size is large, it takes a while to be previewed.

To delete all wallpapers you add, select **Delete All**, then **Yes**.

■ Home Screen

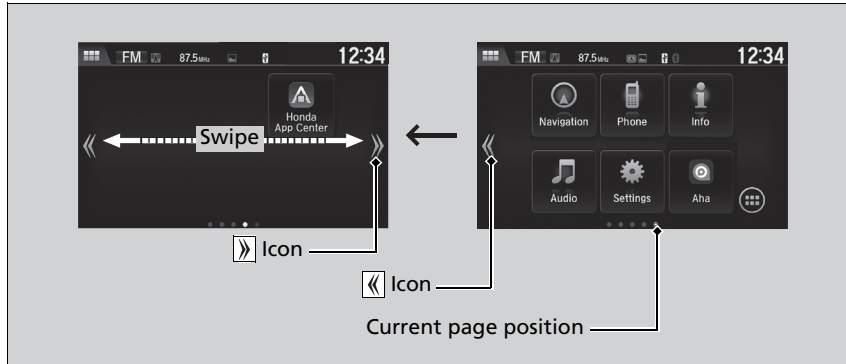
■ To change to a next screen



Selecting  or , or swiping the screen left or right changes to the next screen.

▶ Home Screen

The home screen has 5 pages (fixed). You cannot add any more pages.

■ To use apps or widgets



1. Select .
 - ▶ The **App/Widget List** screen appears.
2. Select the app or widget you want to use.

Preinstall app list:

- **Aha Radio**: Starts up Aha Radio app.
- **Browser**: Displays the web browser utilized by smartphone and Wi-Fi connection.
- **Calculator**: Displays Calculator.
- **Calendar**: Displays Calendar.
- **Clock**: Displays Clock.
- **Downloads**: Displays the data downloaded from the web browser and so on.
- **Gallery**: Displays the image list stored in the audio system.
- **Germin Navigator**: Starts up navigation app.
- **Honda App Center**: Displays Honda App Center.
- **Install App**: Installs and updates app stored in the USB flash drive. However, you can install and update app only through Honda App Center.
- **Music**: Displays the music list stored in the audio system.
- **Search**: Displays various retrieval screens.
- **Settings**: Displays the Android setting screen.

▶▶ To use apps or widgets

Select and hold a selected app or widget to add that app's or widget's shortcut on the home screen.

If preinstall apps do not startup normally, try **Factory Data Reset**.

In case those apps still do not startup normally even after **Factory Data Reset**, contact your dealer.

If you perform **Factory Data Reset**, it may reset all the settings to their factory default.

▶ **Defaulting All the Settings** P. 332

■ To add app or widget icons on the home screen

App or widget icons can be added on the home screen.



1. Select and hold empty space on the home screen.
 - ▶ The pop-up menu appears on the screen.
2. Select **Add App** or **Add Widget**.
 - ▶ The **Add App/Widget** screen appears.



3. Select and hold an app or widget icon you want to add.

▶ The screen switches to the **Home customize** screen.

4. Drag and drop the icon to where you want it to be.

5. Select **OK**.

▶ The screen will return to the home screen.

■ To move icons on the home screen

You can change location on the home screen.



1. Select and hold an icon.
 - ▶ The screen switches to the **Home customize** screen.
2. Drag and drop the icon to where you want it to be.
3. Select **OK**.
 - ▶ The screen will return to the home screen.

▶▶ To move icons on the home screen

You can also move the **Phone**, **Info**, **Audio**, **Settings**, and **Navigation*** icons in the same manner.

■ To delete icons on the home screen

You can delete the icons on the home screen.



1. Select and hold an icon.
 - ▶ The screen switches to the **Home customize** screen.
2. Drag and drop the icon you want to delete to waste basket icon.
 - ▶ The icon is deleted.
3. Select **OK**.
 - ▶ The screen will return to the home screen.

☒ To delete icons on the home screen

You cannot delete the **Phone**, **Info**, **Audio**, **Settings**, and **Navigation*** icons.

Apps or widgets will not be deleted by deleting the icon on the home screen.

* Not available on all models

■ To change a wallpaper of the home screen

You can change a wallpaper of the home screen.

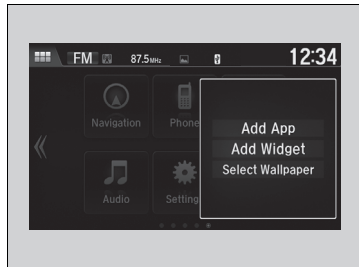

1. Select and hold empty space on the home screen.
 - ▶ The pop-up menu appears on the screen.
2. Select **Select Wallpaper**.
 - ▶ The pop-up menu appears on the screen.

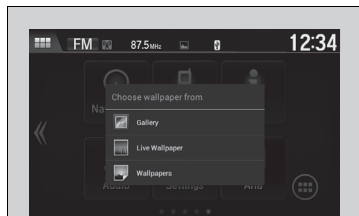

3. Select an app for selecting wallpapers.
4. Select the wallpaper you want to change.
5. Select **Set wallpaper**.
 - ▶ The wallpaper is changed, then the screen will return to the home screen.

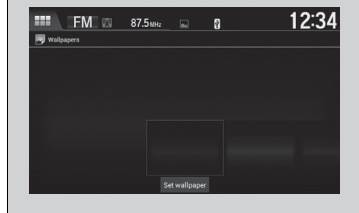



Status Area



Swipe the upper area of the screen.

▶ The status area appears.

Select an item to see the details.

Select  or swipe up the  icon to close the area.

■ Changing the Screen Interface

You can change the screen interface design.



1. Select **HOME**.
2. Select **Settings**.
3. Select **System**.
4. Select the **Others** tab.
5. Select **Skin Change**.
6. A confirmation message appears on the screen. Select **Yes**.

▶▶ Changing the Screen Interface

You need to reboot the system after changing the interface design. Wait a few moments while the system is starting up.

You can change the wallpaper on the audio/information screen.

▶ **Wallpaper Setup** P. 256

If you change the screen interface, some of the setting items will change.

▶ **Customized Features** P. 316

Closing Apps

You can close apps running in the background on the system.

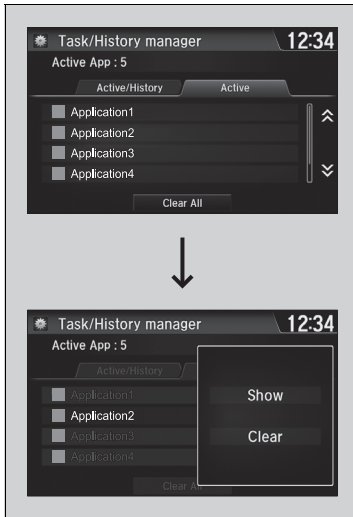

1. Select **HOME**.
2. Select the **Active** tab.
 - ▶ If you select the **Active/History** tab, you can close the apps that are currently running and delete the app activity history simultaneously.
3. Select an app you want to close.
4. Select **Clear**.
 - ▶ The display will return to the app list.

Closing Apps

If you leave the apps used open in the background, some apps may stop operating properly next time using them.

If this happens close unused apps.

To close all apps on the system, select **Clear All**, then **Yes**.

Adjusting the Sound

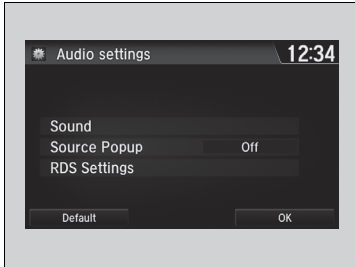

1. Select **HOME**.
2. Select **Settings**.
3. Select **Audio**.
4. Select **Sound**.

Select the tabs to adjust the following choices:
**BASS, TREBLE, FADER, BALANCE, Speed
Volume Compensation (SVC)**

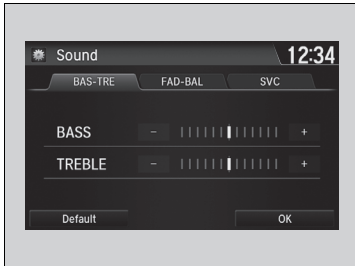

▶▶ Adjusting the Sound

The SVC has four modes: **Off, Low, Mid, and High**. SVC adjusts the volume level based on the vehicle speed. As you go faster, audio volume increases. As you slow down, audio volume decreases.

Display Setup

You can change the brightness or colour theme of the audio/information screen.

Changing the Screen Brightness

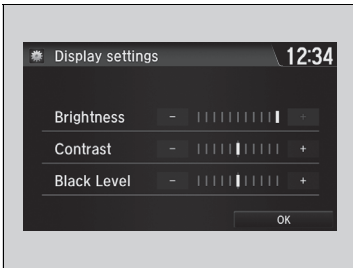

1. Select **HOME**.
2. Select **Settings** to go to the **Settings** screen.
3. Select **System**.
4. Select the **Display** tab.
5. Select **Display Settings**.
6. Select the setting you want.
7. Select **OK**.

Changing the Screen's Colour Theme

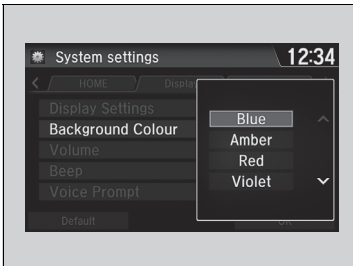

1. Select **HOME**.
2. Select **Settings** to go to the **Settings** screen.
3. Select **System**.
4. Select the **Display** tab.
5. Select **Background Colour**.
6. Select the setting you want.
7. Select **OK**.

▶▶ Changing the Screen Brightness

You can change the **Contrast** and **Black Level** settings in the same manner.

▶▶ Changing the Screen's Colour Theme

Reboot may take a few minutes.

If you default the **System** settings when the colour theme is changed from its default colour, the system reboots.

▶▶ **Customized Features** P. 316

■ Selecting an Audio Source

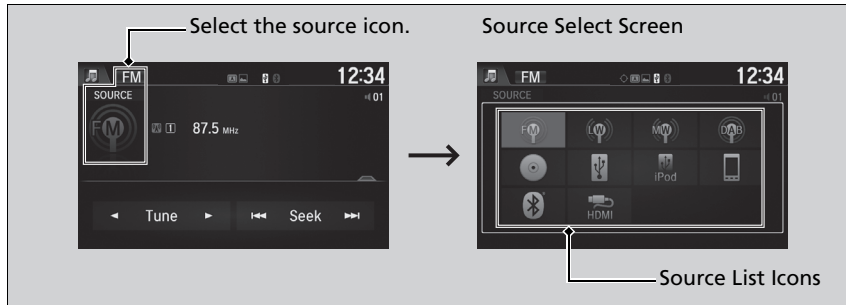

Select the current source icon, then select an icon on the source list to switch the audio source.

■ Limitations for Manual Operation

Certain manual functions are disabled or inoperable while the vehicle is in motion. You cannot select a grayed-out option until the vehicle is stopped.

▶▶ Selecting an Audio Source

If you startup preinstalled audio apps, **AUDIO Apps** is displayed on the upper left of the screen. These preinstalled apps cannot be displayed on the source select screen. You can startup those audio apps from **App/Widget List**.

Playing AM/FM Radio

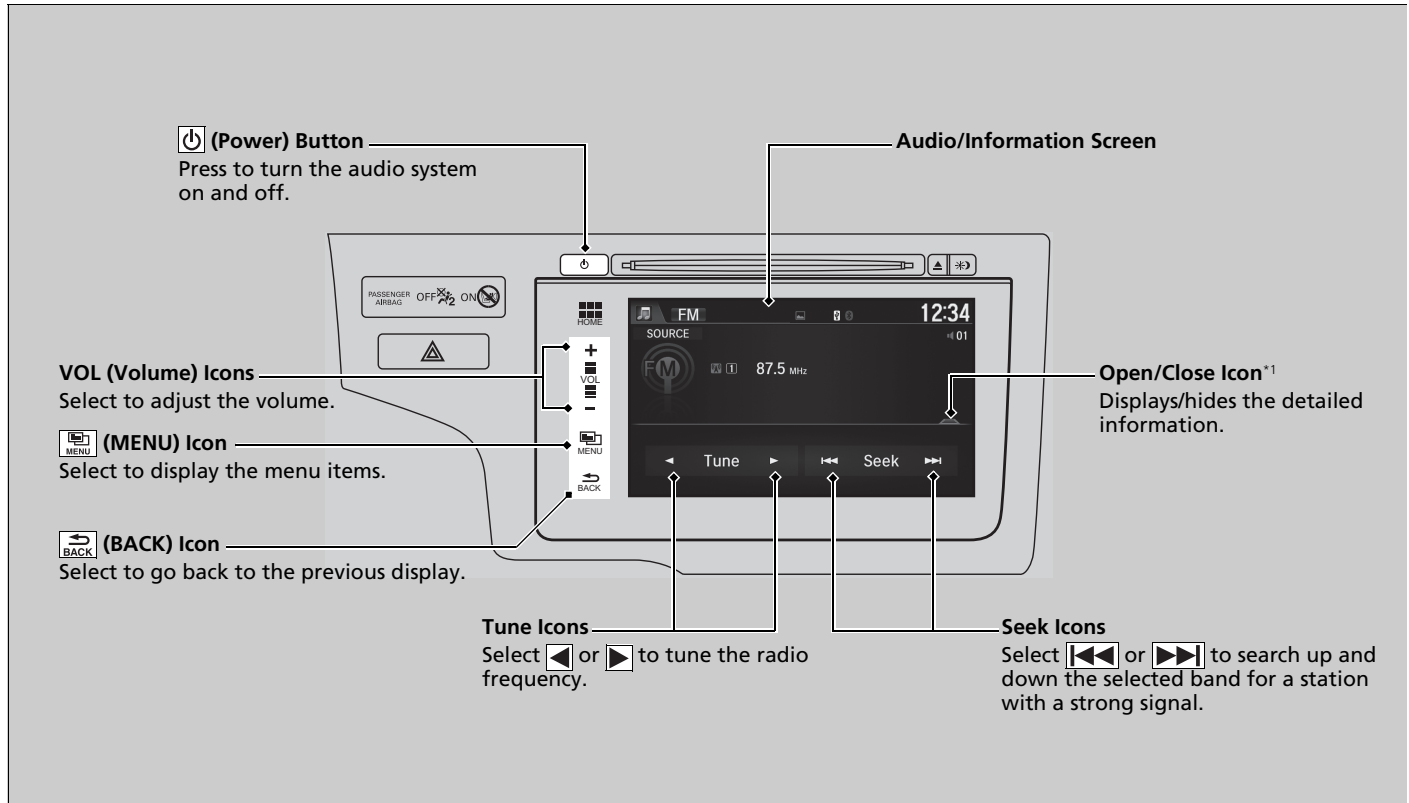

*1:Some or all of the lists may not be displayed.

■ Preset Memory

To store a station:

1. Tune to the selected station.
2. Select **MENU**.
3. Select **Save Preset**.
4. Select the preset number you want to store that station.

▶▶ Playing AM/FM Radio

The **ST** indicator appears on the display indicating stereo FM broadcasts. Stereo reproduction in AM is not available.

Switching the Audio Mode

Press the **SOURCE** button on the steering wheel or select **SOURCE** on the list.

▶ **Audio Remote Controls** P. 219

You can also switch the mode by selecting **Change Source** on the **Audio menu** screen.

You can store 12 AM stations and 12 FM stations into the preset memory. AM has two types of frequencies LW and MW, and each lets you store six stations.

■ Station List

Lists the strongest stations on the selected band.

1. Select **MENU** to switch to the **Audio menu** screen.
2. Select **Station List**.
3. Select the station.

■ Manual update

Updates your available station list at any time.

1. Select **MENU** to switch to the **Audio menu** screen.
2. Select **Station List**.
3. Select **Refresh**.

■ Scan

Samples each of the strongest stations on the selected band for 10 seconds.

1. Select **MENU**.
2. Select **Scan**.

To turn off scan, select **Cancel**.

■ Radio Data System (RDS)*

Provides text data information related to your selected RDS-capable FM station.

■ To find an RDS station from Station List

1. Select **MENU** while listening to an FM station.
2. Select **Station List**.
3. Select the station.

■ Manual update

Updates your available station list at any time.

1. Select **MENU** while listening to an FM station.
2. Select **Station List**.
3. Select **Update List**.

☒ Radio Data System (RDS)*

When you select an RDS-capable FM station, the RDS automatically turns on, and the frequency display changes to the station name. However, when the signals of that station become weak, the display changes from the station name to the frequency.

■ Radio text

Displays the radio text information of the selected RDS station.

1. Select **MENU**.
2. Select **Radio Text**.

■ Scan

Samples each of the strongest stations on the selected band for 10 seconds.

1. Select **MENU**.
2. Select **Scan**.

To turn off scan, select **Cancel Scan**.

Playing DAB (Digital Audio Broadcasting)*

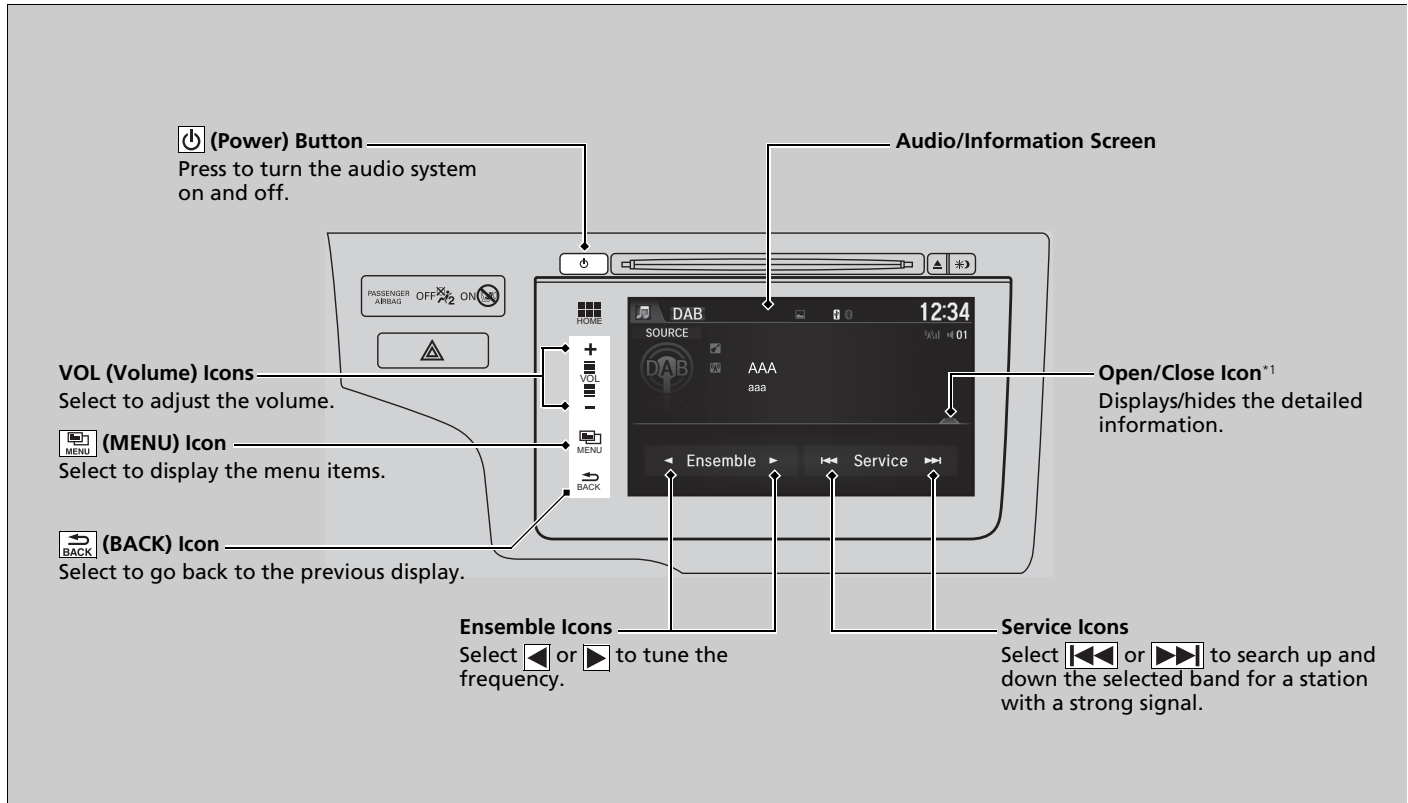

*1: Some or all of the lists may not be displayed.

■ Preset Memory

Stores a station:

1. Tune to the selected station.
2. Select **MENU**.
3. Select **Save Preset**.
4. Select the preset number for the station you want to store.

■ Ensemble List

Lists the strongest stations.

1. Select **MENU**.
2. Select **Ensemble List**.
3. Select the station.

■ Manual update

Updates your available station list at any time.

1. Select **MENU**.
2. Select **Ensemble List**.
3. Select **Update List**.

■ Scan

Samples each of the strongest stations on the selected band for 10 seconds.

1. Select **MENU**.
2. Select **Scan**.
3. Select **Scan Ensemble** or **Scan Service**.

To turn off scan, select **Cancel Scan**.

▶▶ Playing DAB (Digital Audio Broadcasting)*

Switching the Audio Mode

Press the **SOURCE** button on the steering wheel or select **SOURCE** on the screen.

▶ **Audio Remote Controls** P. 219

You can also switch the mode by selecting **Change Source** on the **Audio menu** screen.

You can store 12 DAB stations into preset memory.

■ Radio text

Displays the radio text information of the selected DAB station.

1. Select **MENU**.
2. Select **Radio Text**.

Playing a CD

Your audio system supports audio CDs, CD-Rs and CD-RWs in either MP3, WMA, or AAC*1 format. With the CD loaded, select the CD mode.

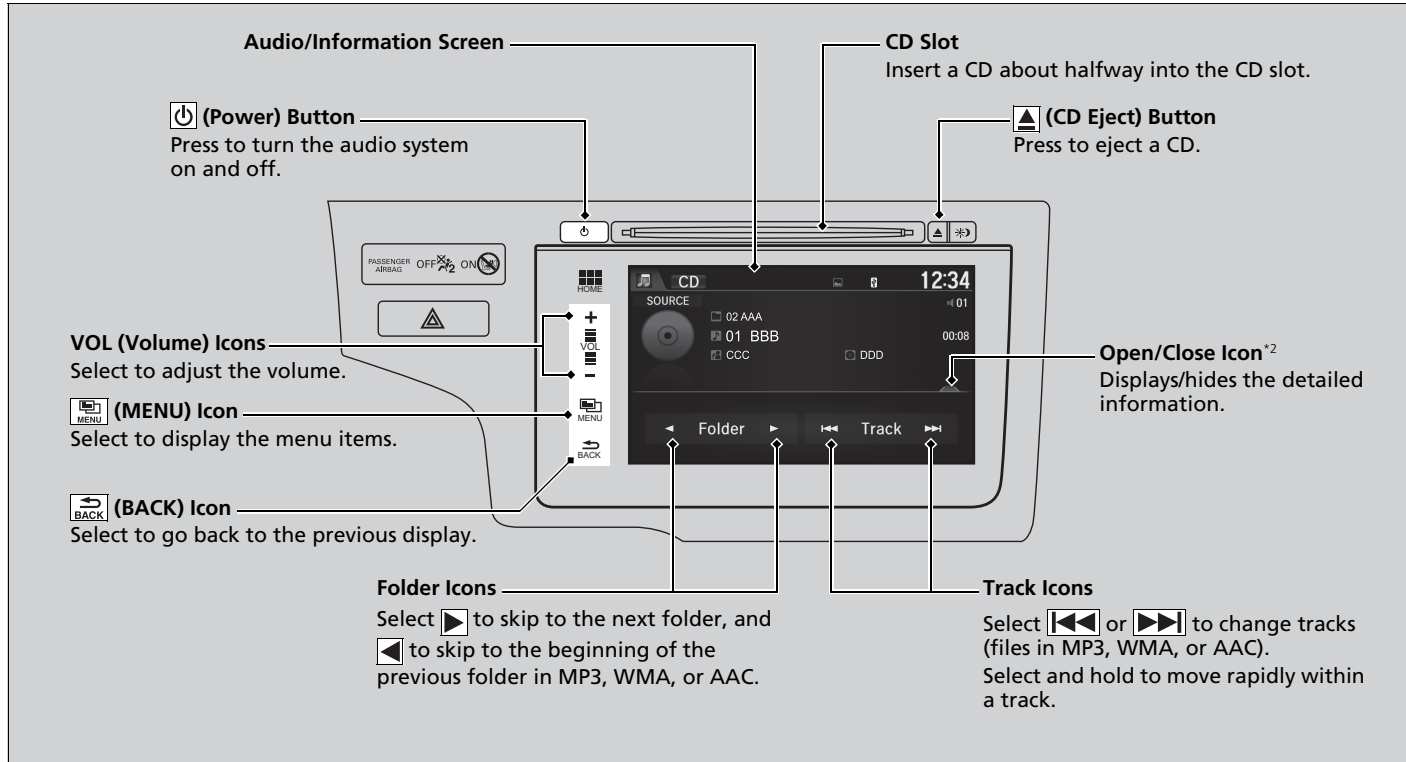

*1: Only AAC format files recorded with iTunes are playable on this unit.

*2: Some or all of the lists may not be displayed.

How to Select a File from the Music Search List (MP3/WMA/AAC)

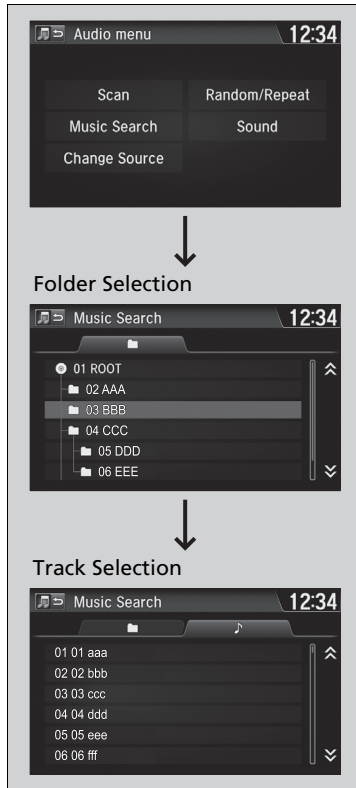

1. Select **MENU** and select **Music Search**.

2. Select a folder.

3. Select a track.

▶▶ Playing a CD

NOTICE

Do not use CDs with adhesive labels. The label can cause the CD to jam in the unit.

WMA files protected by digital rights management (DRM) cannot be played.

The audio system displays **Unplayable File**, then skips to the next file.

Text data appears on the display under the following circumstances:

- When you select a new folder, file, or track.
- When you change the audio mode to CD.
- When you insert a CD.

If you eject the CD but do not remove it from the slot, the system reloads the CD automatically after several seconds.

How to Select a Play Mode

You can select scan, repeat, and random modes when playing a track or file.

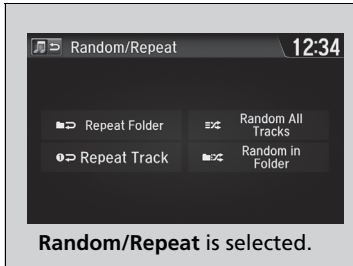

1. Select **MENU**.
2. Select **Scan** or **Random/Repeat**.
3. Select a mode.

To turn off a play mode

1. Select **MENU**.
2. Select the mode you want to turn off.

How to Select a Play Mode

Play Mode Menu Items

Scan

Scan Folders (MP3/WMA/AAC): Provides 10-second sampling of the first file in each of the main folders.

Scan Tracks: Provides 10-second sampling of all tracks on the CD (all files in the current folder in MP3, WMA, or AAC).

Random/Repeat

Repeat Folder (MP3/WMA/AAC): Repeats all files in the current folder.

Repeat Track: Repeats the current track/file.

Random in Folder (MP3/WMA/AAC): Plays all files in the current folder in random order.

Random All Tracks: Plays all tracks/files in random order.

Playing an iPod

Connect the iPod using your dock connector to the USB port, then select the iPod mode.

➤ **USB Port(s)** P. 215

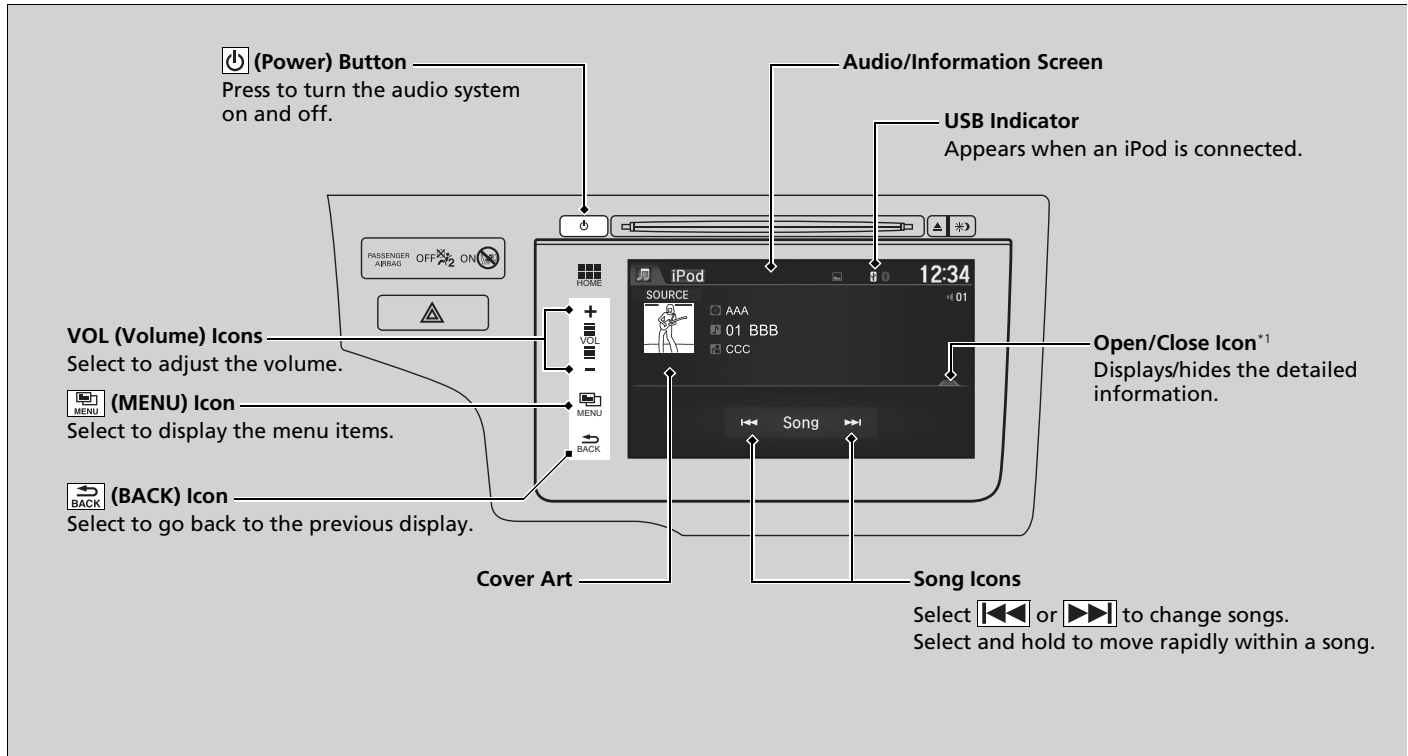

*1: Some or all of the lists may not be displayed.

How to Select a Song from the Music Search List

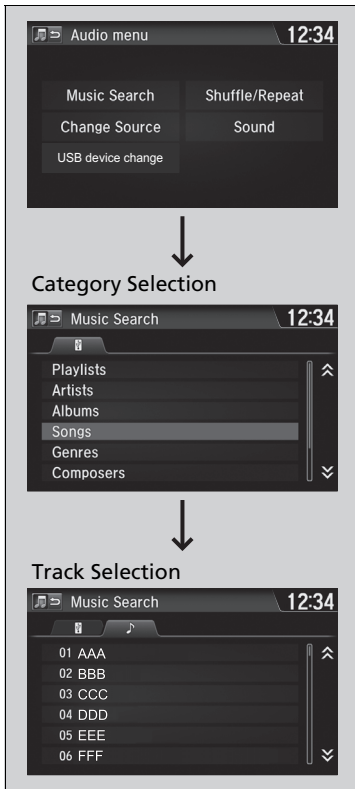

1. Select **MENU** and select **Music Search**.
2. Select the items on that menu.

How to Select a Song from the Music Search List

Available operating functions vary on models or versions. Some functions may not be available on the vehicle's audio system.

If there is a problem, you may see an error message on the audio/information screen.

▶ **iPod/USB Flash Drive** P. 300

If you operate the music app on your iPhone/iPod while the phone is connected to the display audio system, you may no longer be able to operate the same app on the display audio. Reconnect the device if necessary.

Select **USB device change** in the **Audio menu** screen to switch to another USB device.

■ How to Select a Play Mode

You can select repeat and shuffle modes when playing a file.

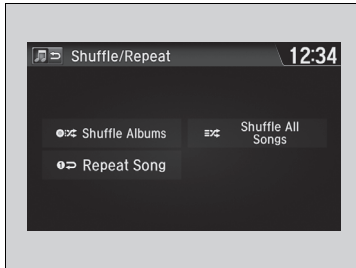

1. Select **MENU**.
2. Select **Shuffle/Repeat**.
3. Select a mode.

■ To turn off a play mode

1. Select **MENU**.
2. Select the mode you want to turn off.

▶▶ How to Select a Play Mode

Play Mode Menu Items

Shuffle Albums: Plays all available albums in a selected list (playlists, artists, albums, songs, podcasts, genres, composers, or audiobooks) in random order.

Shuffle All Songs: Plays all available files in a selected list (playlists, artists, albums, songs, podcasts, genres, composers, or audiobooks) in random order.

Repeat Song: Repeats the current file.

Playing a USB Flash Drive

Your audio system reads and plays sound files on a USB flash drive in either MP3, WMA, AAC*1, or WAV format.

Connect your USB flash drive to the USB port, then select the USB mode.

📌 **USB Port(s)** P. 215

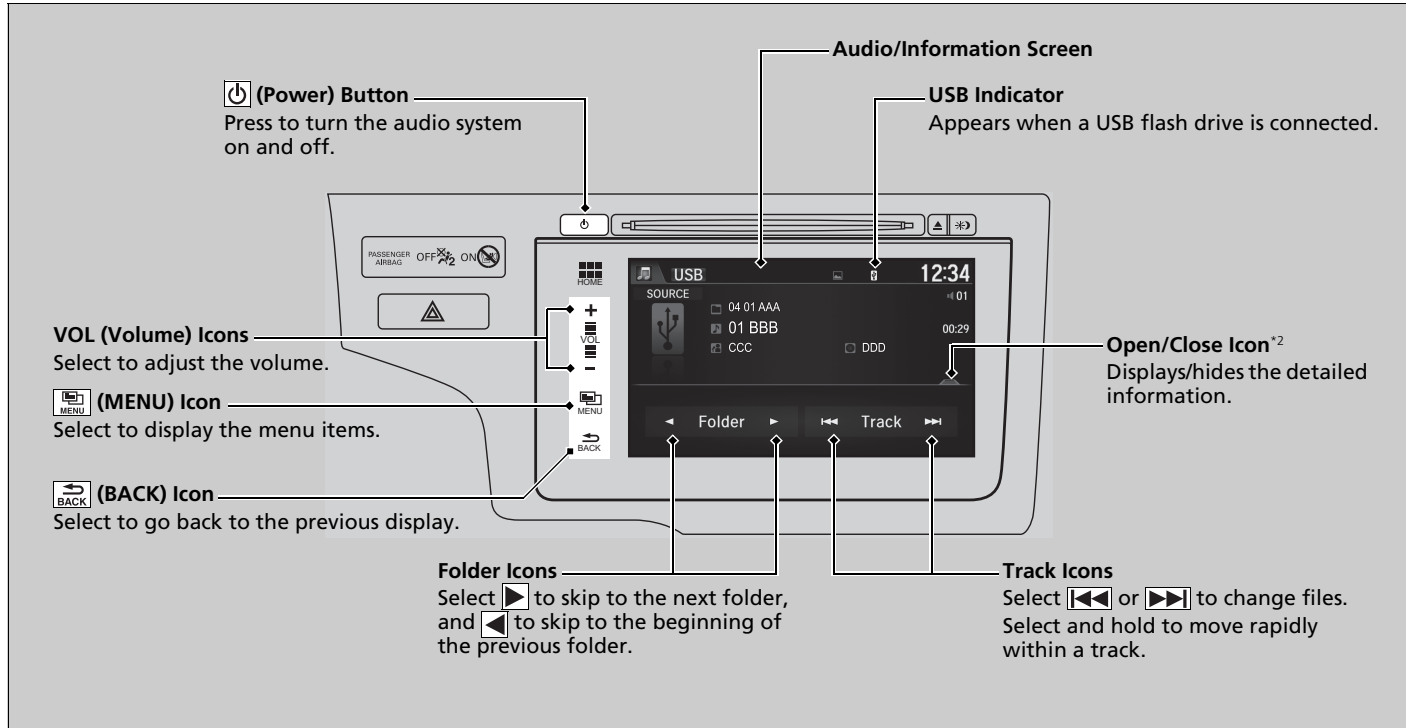

*1: Only AAC format files recorded with iTunes are playable on this unit.

*2: Some or all of the lists may not be displayed.

How to Select a File from the Music Search List

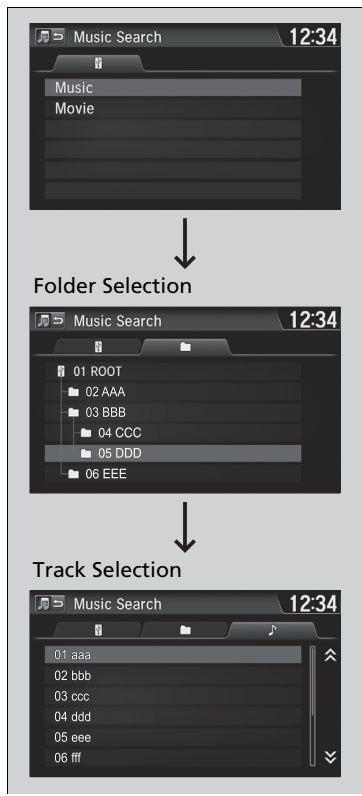

1. Select **MENU** and select **Music Search**.
2. Select **Music** or **Movie**.

3. Select a folder.

4. Select a track.

▶▶ Playing a USB Flash Drive

Use the recommended USB flash drives.

▶ **General Information on the Audio System**
P. 305

Files in WMA format protected by digital rights management (DRM) are not played.

The audio system displays **Unplayable File**, and then skips to the next file.

If there is a problem, you may see an error message on the audio/information screen.

▶ **iPod/USB Flash Drive** P. 300

Select **USB device change** in the **Audio menu** screen to switch to another USB device.

How to Select a Play Mode

You can select scan, repeat, and random modes when playing a file.

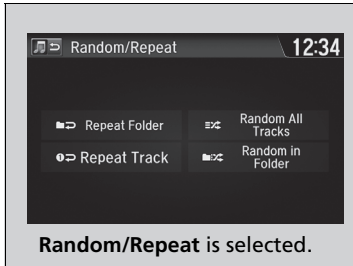

1. Select **MENU**.
2. Select **Scan** or **Random/Repeat**.
3. Select a mode.

To turn off a play mode

1. Select **MENU**.
2. Select the mode you want to turn off.

How to Select a Play Mode

Play Mode Menu Items

Scan

Scan Folders: Provides 10-second sampling of the first file in each of the main folders.

Scan Tracks (Scan Movies*1): Provides 10-second sampling of all files in the current folder.

Random/Repeat

Repeat Folder: Repeats all files in the current folder.

Repeat Track (Repeat Movies*1): Repeats the current file.

Random in Folder: Plays all files in the current folder in random order.

Random All Tracks (Random All Movies*1): Plays all files in random order.

When playing a video file:

Play/Pause: Select to resume or play a file.

Stop: Select to stop a file.

*1: When playing a video file

Playing *Bluetooth*® Audio

Your audio system allows you to listen to music from your *Bluetooth*-compatible phone.

This function is available when the phone is paired and connected to the vehicle's Hands-Free Telephone (HFT) system.

☑ **Phone Setup** P. 362

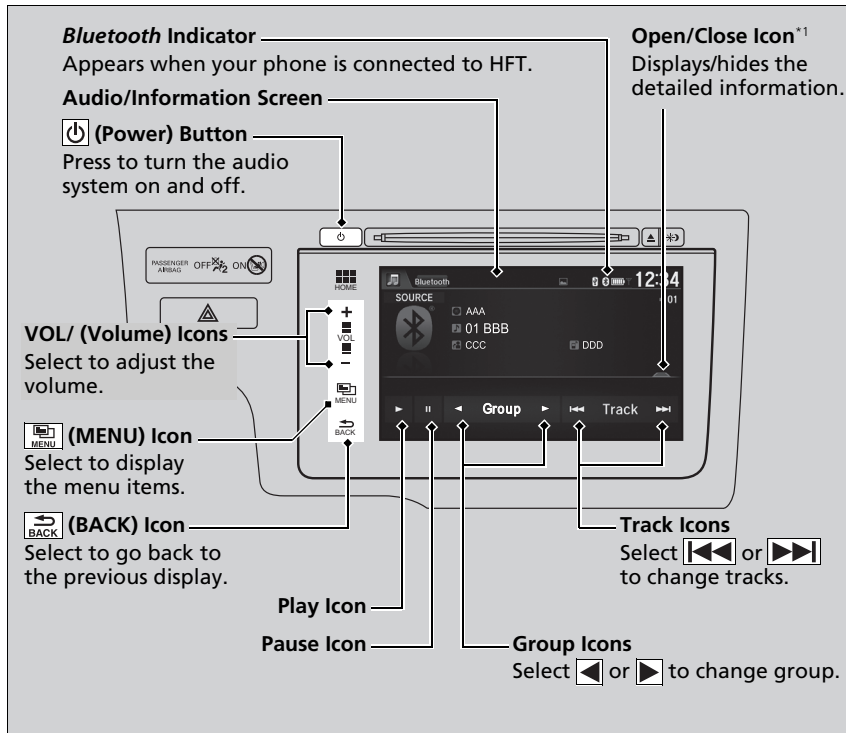

▶▶ Playing *Bluetooth*® Audio

Not all *Bluetooth*-enabled phones with streaming audio capabilities are compatible with the system. To check if your phone is compatible, ask a dealer.

It may be illegal to perform some data device functions while driving.

Only one phone can be used with HFT at a time. When there are more than two paired phones in the vehicle, the first paired phone the system finds is automatically linked.

If more than one phone is paired to the HFT system, there may be a delay before the system begins to play.

In some cases, the name of the artist, album, or track may not appear correctly.

A **No Device Connected** message may be displayed if:

- The phone is not linked to HFT.
- The phone is not turned on.
- The phone is not in the vehicle.
- An incompatible phone is connected.

Some functions may not be available on some devices.

*1: Depending on the *Bluetooth*® device you connect, some or all of the lists may not be displayed.

To Play *Bluetooth*® Audio Files

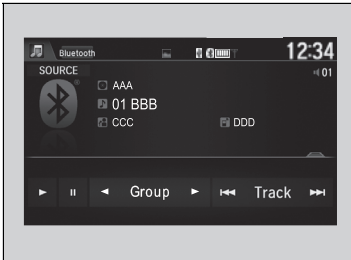

1. Make sure that your phone is paired and connected to the system.
2. Select the *Bluetooth*® Audio mode.

If the phone is not recognized, another HFT-compatible phone, which is not compatible for *Bluetooth*® Audio, may already be connected.

■ To pause or resume a file

Select the play icon or pause icon.

Searching for Music

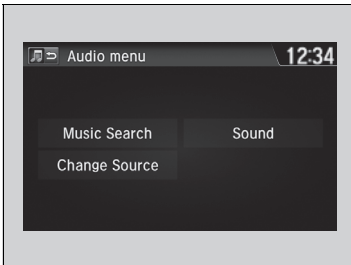

1. Select **MENU**.
2. Select **Music Search**.
3. Select a search category (e.g., Albums).
4. Select an item.
 - ▶ The selection begins playing.

☒ To Play *Bluetooth*® Audio Files

To play the audio files, you may need to operate your phone. If so, follow the phone maker's operating instructions.

Switching to another mode pauses the music playing from your phone.

☒ Searching for Music

Depending on the *Bluetooth*® device you connect, some or all of the lists may not be displayed.

Playing a Video Using the HDMI™

Your audio system allows you to play videos from an HDMI™-compatible device. Connect the device, using an HDMI™ cable, then select the HDMI™ mode.

➤ **HDMI™ Port*** P. 216

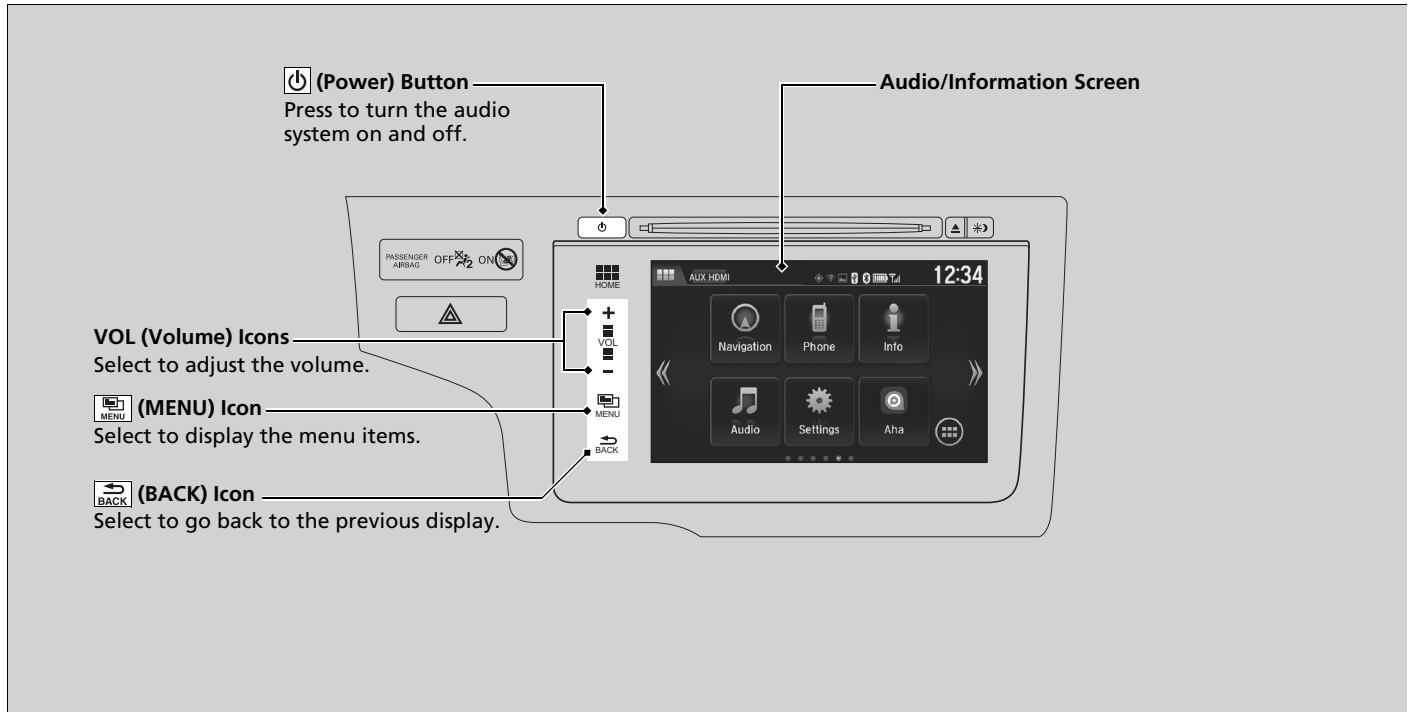

Changing the Screen Aspect



1. Select **HOME**.
2. Select **Settings** to go to the **Settings** screen.
3. Select **Audio**.
4. Select **Aspect Adjustment**.
5. Select the setting you want.
6. Select **OK**.

▶▶ Playing a Video Using the HDMI™

This feature is limited while driving. To play videos, stop your vehicle and apply the parking brake.

On Board Apps

Honda Connect has the capability of On Board Apps which may be created by Honda or by 3rd parties. Apps may be already installed or can be downloaded through Honda App Center. Some Apps require internet access which can be established by Wi-Fi Connection.

➤ **Wi-Fi Connection** P. 296

Please visit the below web address for further information:

<https://livhs.os.ixonos.com/honda/help>

▶▶ On Board Apps

Make sure the GPS setting is turned on before using Honda App center.

➤ **Customized Features** P. 316

Even if you change **Background Colour** on the **System settings** screen, it will not be reflected on the Honda App Center screen.

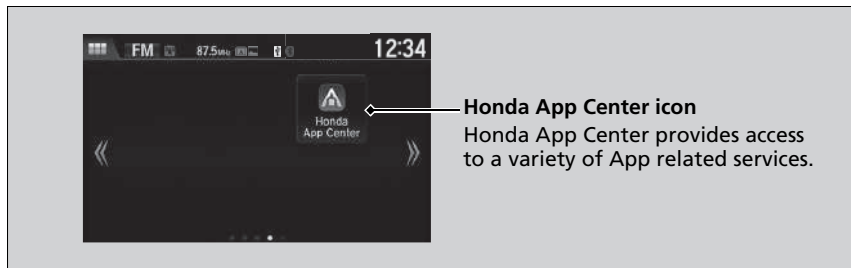

- Using the Display Audio system while driving can take your attention away from the road, causing a crash in which you could be seriously injured or killed. Only operate system controls when the conditions permit you to safely do so. **Please always adhere to the laws of the territory when operating this device.**
- Applications on the head unit are subject to change at anytime. This may mean that they are not available or operate differently. Honda shall not be liable to you in such instances.
- Applications available on the device may be provided by parties other than Honda to which 3rd party software licences and charges may apply.
- Data usage and roaming charges may result in using applications on the device in conjunction with your mobile phone and Honda is not liable for any costs you might incur from such use. Honda recommends you consult your mobile phone network provider in advance.
- Downloading applications from the Honda App Center will be subject to Terms and Conditions which can be found at: <https://livhs.os.ixonos.com/honda/help>, and may also incur charges.

Smartphone Connection

Some of your smartphone apps can be displayed and operated on the audio/information screen when the phone is connected to the audio system. You can connect your phone using a cable, or wirelessly.

📌 **Connecting Your iPhone** P. 295

📌 **Wi-Fi mode (setting for the first time)** P. 296

Smartphone Connection

Park in a safe place before connecting your phone and while operating the displayed apps.

Not all phones are compatible with the system. The system does not display all the available apps on smartphone, and some apps need to be preinstalled. Ask a dealer for details.

You need to switch the *Bluetooth*® connection to your smartphone if another electronic device is connected.

📌 **To change the currently paired phone**
P. 363

The following may vary by phone type:

- Connection methods.
- How to connect a smartphone to the system.
- Apps that can be operated on the screen.
- Display response time/update time

We do not support every app operation on the display audio.

Ask the app provider for any questions on the app's features.

Do not get drawn into the display while operating a vehicle.

To use smartphone connection, you need to first pair your smartphone to the audio system via *Bluetooth*®.

➔ **Phone Setup** P. 362

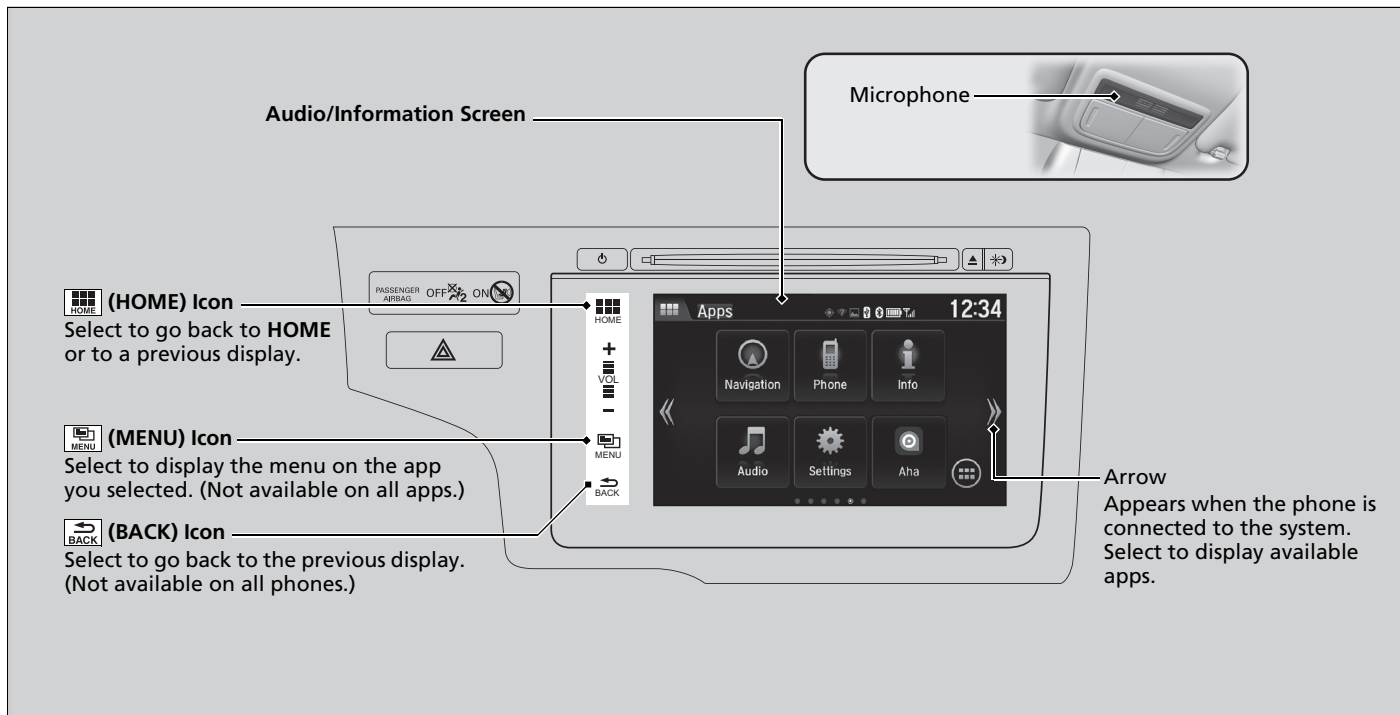

■ Connecting Your iPhone

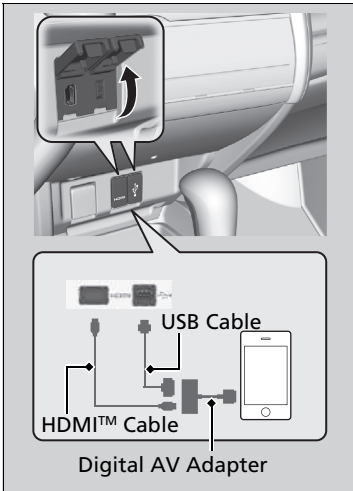

1. Connect your phone to the display audio via *Bluetooth*®.
 - ▶ **Phone Setup** P. 362
2. Plug in the digital AV adapter to the HDMI™ jack.
3. Connect the digital AV adapter to your iPhone.
 - ▶ Wait until an arrow appears on the home screen.
4. Select the arrow to display the available smartphone apps on the audio/information screen.
 - ▶ You may need to operate from the phone.
5. Select an app you want to operate from the audio/information screen.
 - ▶ To go back to the previous screen, select **HOME**.

☒ Connecting Your iPhone

Make sure to plug in the digital AV adapter to the HDMI™ jack first. If not, smartphone connection may not work properly.

To recharge your phone, connect it to the USB jack, too.

Contact a dealer for the digital AV adapter or HDMI™ cable purchasing information.

Wi-Fi Connection

You can connect the display audio system to the Internet using Wi-Fi and browse websites or use online services on the audio/information screen. If your phone has mobile hotspot capabilities, the system can be tethered to the phone. Go through the following steps for a setup.

Wi-Fi mode (setting for the first time)



1. Select **HOME**.
2. Select **Settings**.
3. Select **Bluetooth / Wi-Fi**.
4. Select the **Wi-Fi** tab.
5. Select **Wi-Fi On/Off Status**, then **On**.
6. Select **Wi-Fi Device List**.
 - ▶ Make sure your phone's Wi-Fi setting is in access point (tethering) mode.
 - ▶ Select the phone you want to connect to the system.
 - ▶ If you do not find the phone you want to connect in the list, select **Scan**.

Wi-Fi mode (setting for the first time)

You cannot go through the setting procedure while a vehicle is moving. Park in a safe place to set the audio system in Wi-Fi mode.

Some telecom carriers charge for tethering. Check your phone's subscribed package.

Check your phone manual to find out if the phone has Wi-Fi connectivity.

You can confirm whether Wi-Fi connection is on or off with the  icon on **Wi-Fi Device list**. Transmission speed and others will not be displayed on this screen.



7. Select **Connect**.

- ▶ Enter a password for your phone, and select **Done**.
- ▶ If you cannot enter the password on the displayed keyboard, change the keyboard to the one in which you can enter from the Android setting.
 - ▣ **Customized Features** P. 316
- ▶ When the connection is successful, the  icon is displayed on the list.

8. Select **HOME** to go back to the home screen.

Wi-Fi mode (after the initial setting has been made)

Make sure your phone's Wi-Fi setting is in access point (tethering) mode.

▶▶ Wi-Fi mode (setting for the first time)

If you cannot enter the password on the displayed keyboard, change the keyboard to the one in which you can enter from the following order:

Settings→**Android**→**Language & input**→select  next to **Android keyboard**→**Input language**→uncheck the box next to **Use system language**→select the keyboard languages that you can enter.

▶▶ Wi-Fi mode (after the initial setting has been made)

iPhone users

You may need to go through an initial setup for Wi-Fi connection again after you boot your phone.

Siri Eyes Free

You can talk to Siri using the  (Talk) button on the steering wheel when your iPhone is paired to the Hands-Free Telephone (HFT) System.

➔ **Phone Setup** P. 362

Using Siri Eyes Free

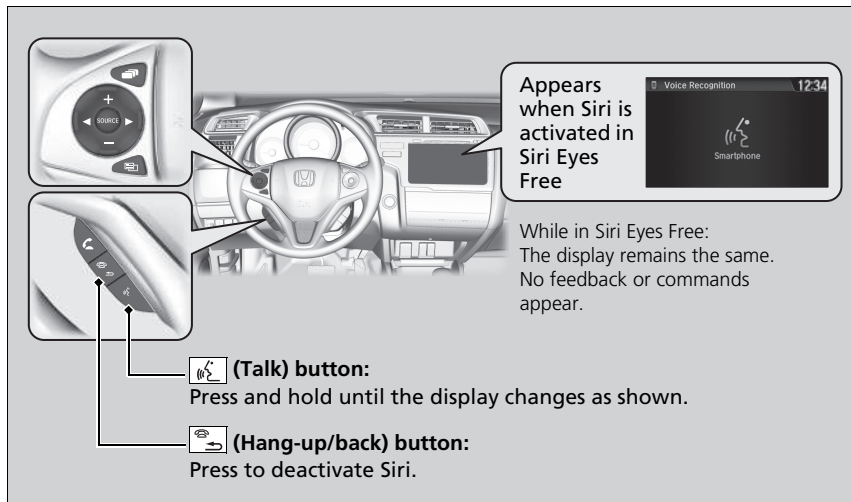

▶▶ Siri Eyes Free

Siri is a trademark of Apple Inc.

Check Apple Inc, website for features available for Siri.





We recommend against using Siri other than in Siri Eyes Free while operating a vehicle.

▶▶ Using Siri Eyes Free

Some commands work only on specific phone features or apps.

CD Player

If a disc error occurs, you may see the following error messages.

Error Message	Cause	Solution
Unplayable file* ¹ Unplayable File* ²	Track/file format not supported	<ul style="list-style-type: none"> Current track/file will be skipped. The next supported track/file plays automatically.
Bad disc Please check owners manual Push eject* ¹ Bad Disc Please Check Owner's Manual Push Eject* ²	Mechanical error	<ul style="list-style-type: none"> Press the  (eject) button and remove the disc, and check that the error message is cleared. Check that the disc is not damaged or deformed, and insert the disc again. <ul style="list-style-type: none">  Protecting CDs P. 303 If the error message reappears, press the  button, and pull out the disc. Insert a different disc. <ul style="list-style-type: none"> If the new disc plays, there is a problem with the first disc. If the error message repeats, or the disc cannot be removed, contact a dealer. <ul style="list-style-type: none"> Do not try to force the disc out of the player.
Mechanical error* ¹ Mecha Error* ²		
Bad disc Please check owners manual* ¹ Bad Disc Please Check Owner's Manual* ²	Servo error	<ul style="list-style-type: none"> If the error message repeats, or the disc cannot be removed, contact a dealer. <ul style="list-style-type: none"> Do not try to force the disc out of the player.
Check disc* ¹ Check Disc* ²	Disc error	<ul style="list-style-type: none"> Check that the disc is not damaged or deformed. <ul style="list-style-type: none">  Protecting CDs P. 303
Heat error* ¹ Heat Error* ²	High temperature	<ul style="list-style-type: none"> Turn the audio system off and allow the player to cool down until the error message is cleared.

*1: Colour audio system

*2: Display audio system

iPod/USB Flash Drive

If an error occurs while playing an iPod or USB flash drive, you may see the following error messages. If you cannot clear the error message, contact a dealer.

Error Message	Solution
USB error ^{*1} USB Error ^{*2}	Appears when there is a problem with the USB adapter unit. Check if the device is compatible with the USB adapter unit.
Incompatible USB device Please check owner's manual ^{*1} Bad USB Device Please Check Owners Manual ^{*2}	Appears when an incompatible device is connected. Disconnect the device. Then turn the audio system off, and turn it on again. Do not reconnect the device that caused the error.
Unsupported ver ^{*1} Unsupported Version ^{*2}	Appears when an unsupported iPod is connected. If it appears when a supported iPod is connected, update the iPod software to the newer version.
Retry connection ^{*1} Connect Retry ^{*2}	Appears when the system does not acknowledge the iPod. Reconnect the iPod.
Unplayable file ^{*1} Unplayable File ^{*2}	Appears when the files in the USB flash drive are DRM or an unsupported format. This error message appears for about three seconds, then plays the next song.
No data ^{*1} No song ^{*1} No Data ^{*2}	<p>iPod Appears when the iPod is empty.</p> <p>USB flash drive Appears when the USB flash drive is empty or there are no MP3, WMA, or AAC files in the USB flash drive.</p> <p>iPod and USB flash drive Check that compatible files are stored on the device.</p>
Unsupported	Appears when an unsupported device is connected. If it appears when a supported device is connected, reconnect the device.





*1 : Colour audio system

*2 : Display audio system

Models with display audio system

Android/Apps

If an error occurs while using the audio system or apps, you may see the following error messages. If you cannot clear the error message, contact a dealer.

Error Message* ¹	Solution
Unfortunately, **** has stopped.	<p>Error has occurred within app, select OK on the screen to close the app. Unless it is a fatal error, it would return to normal if you startup the app.</p> <p>If it does not return to normal even after starting up the app, press and hold the  (power) button to perform the forced reset. If it still does not get back to normal, you need Factory Data Reset.</p> <p> Defaulting All the Settings P. 332</p>
**** is not responding. Would you like to close it?	<p>App is in a busy state.</p> <p>Select Wait if you can wait for a response from app a little longer. If it does not respond even if you keep waiting, select OK to close the app and start it up. When it does not return to normal, press and hold the  (power) button to perform the forced reset. You also need Factory Data Reset.</p> <p> Defaulting All the Settings P. 332</p>
Security warning	<p>Occurs if you open the browser when the system date is older than the certificate date information. It also occurs when you are in the area where GPS reception is unavailable or GPS setting of the Android setting is turned off.</p> <ul style="list-style-type: none"> • Turn on GPS setting of the Android setting. • Move to the area where GPS reception is available. <p> Customized Features P. 316</p>

*1: ****part is variable characters, and will change depending upon where an error occurs.

Recommended CDs

- Use only high-quality CD-R or CD-RW discs labeled for audio use.
- Use only CD-R or CD-RW discs on which the recordings are closed.
- Play only standard round-shaped CDs.

The CD packages or jackets should have one of these marks.



CDs with MP3, WMA, or AAC files

- Some software files may not allow for audio play or text data display.
- Some versions of MP3, WMA, or AAC formats may be unsupported.

Recommended CDs

A Dual-disc cannot play on this audio unit. If recorded under certain conditions, a CD-R or CD-RW may not play either.

■ Protecting CDs

Follow these precautions when handling or storing CDs:

- Store a CD in its case when it is not being played.
- When wiping a CD, use a soft clean cloth from the centre to the outside edge.
- Handle a CD by its edge. Never touch either surface.
- Never insert foreign objects into the CD player.
- Keep CDs out of direct sunlight and extreme heat.
- Do not place stabilizer rings or labels on the CD.
- Avoid fingerprints, liquids, and felt-tip pens on the CD.

▶▶ Protecting CDs

NOTICE

Do not insert a damaged CD. It may be stuck inside and damage the audio unit.

Examples:

- Bubbled, wrinkled, labeled, and excessively thick CDs

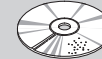

Bubbled/
Wrinkled

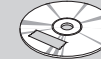

With Label/
Sticker



Using
Printer Label
Kit

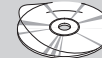

Sealed

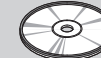

With Plastic Ring

- Damaged CDs

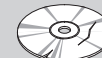

Chipped/
Cracked

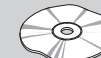

Warped

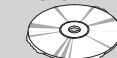

Burrs

- Poor quality CDs

- Small CDs



8-cm
CD

Compatible iPod, iPhone, and USB Flash Drives

■ iPod and iPhone Model Compatibility

Model
iPod (5th generation)
iPod classic 80GB/160GB (launch in 2007)
iPod classic 120GB (launch in 2008)
iPod classic 160GB (launch in 2009)
iPod nano (1st to 6th generation) launch in 2010
iPod nano (7th generation) launch in 2012
iPod touch (1st to 4th generation) launch in 2010
iPod touch (5th generation) launch in 2012
iPhone 3G/iPhone 3GS/iPhone 4/iPhone 4s/iPhone 5/iPhone 5c*1/iPhone 5s*1

*1 : Display audio system

⌘ iPod and iPhone Model Compatibility

This system may not work with all software versions of these devices.

USB Flash Drives

- Use a recommended USB flash drive of 256 MB or higher.
- Some digital audio players may not be compatible.
- Some USB flash drives (e.g., a device with security lockout) may not work.
- Some software files may not allow for audio play or text data display.
- Some versions of MP3, WMA, AAC or WAV* formats may be unsupported.

Models with display audio system

Recommended Devices

Media	CD-R/CD-RW/USB Flash Drive	
Profile (MP4 version)	Baseline Level 3 (MPEG4-AVC), Simple Level 5 (MPEG4)	
File extension (MP4 version)	.mp4/.m4v	
Compatible audio codec	MPEG4-AVC (H.264)	MPEG4 (ISO/IEC 14496 Part.2)
Bit rate	10 Mbps (MPEG4-AVC)	8 Mbps (MPEG4)
Maximum image	720 X 576 pixels	

* Not available on all models

USB Flash Drives

Files on the USB flash drive are played in their stored order. This order may be different from the order displayed on your PC or device.

Models with display audio system



About Open Source Licences

To see the open source licence information, follow these steps.

1. Select **HOME**.
2. Select **Settings**.
3. Select **Android**.
4. Select **About device**.
5. Select **Legal information**.
6. Select **Open source licences**.

▶▶ About Open Source Licences

You can also go to step 4 when you:

- Swipe down from the top.
 - ▶ Select  appears on the screen.
- Select , then select **Settings** on the **App** tab.

Customized Features

Models with colour audio system

Use the audio/information screen to customize certain features.

■ How to customize

While the vehicle is at a complete stop with the ignition switch in ON [II], press the **MENU/CLOCK** button, then select **Settings**. To customize the phone settings, press the  button, then select **Phone setup**.

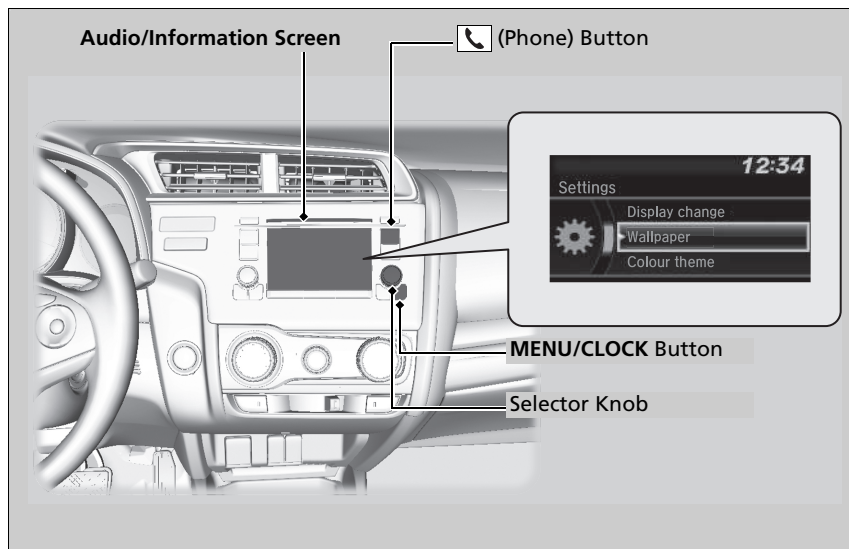

Customized Features

When you customize settings:

- Make sure that the vehicle is at a complete stop.

Continuously variable transmission models

- Shift to [P].

Manual transmission models



- Set the parking brake.

How to customize

These indications are used to show how to operate the selector knob.

Rotate  to select.

Press  to enter.

To customize other features, select **Settings**, rotate , and press .

➤ **List of customizable options** P. 312

Continued

■ Customization flow

Press the **MENU/CLOCK** button.

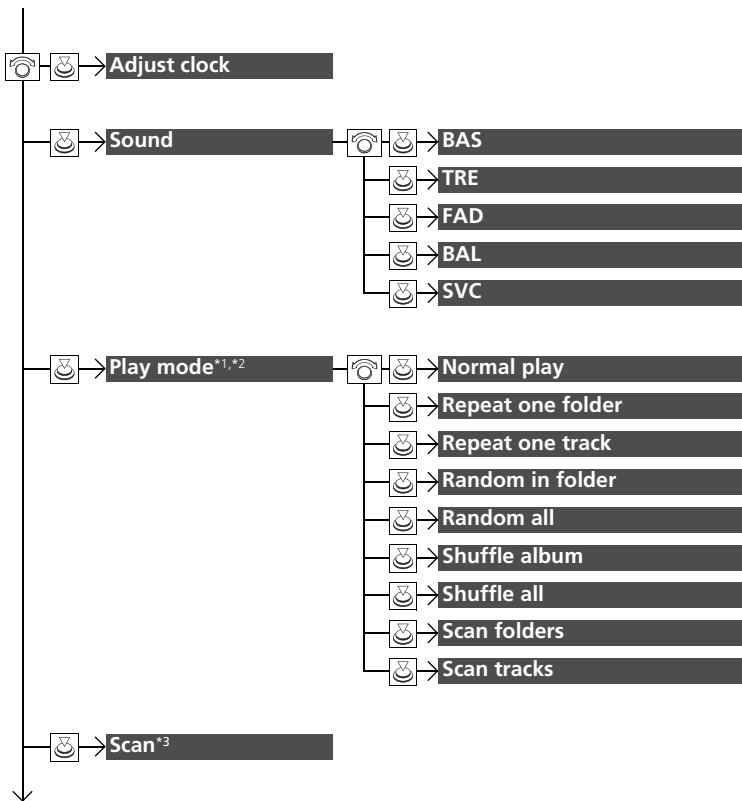

*1: The items of play mode depend on audio modes.

*2: CD/iPod/USB mode

3: AM/FM/DAB mode

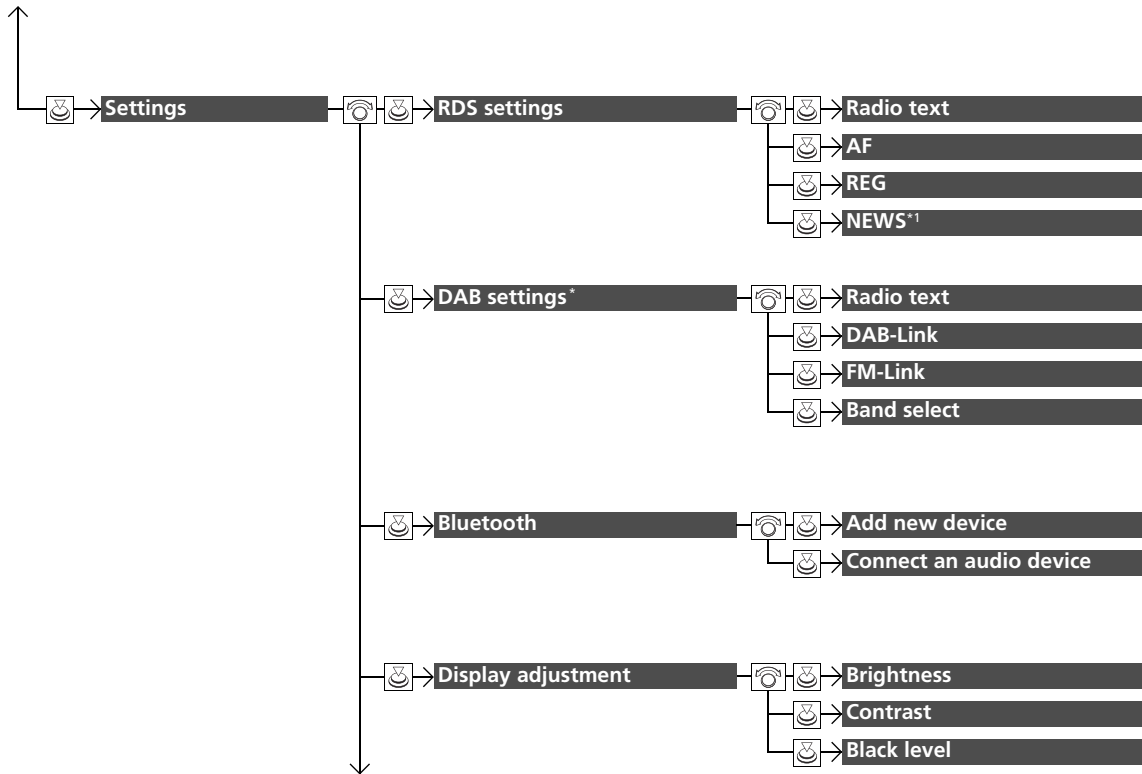

1: Except AM/FM/DAB mode

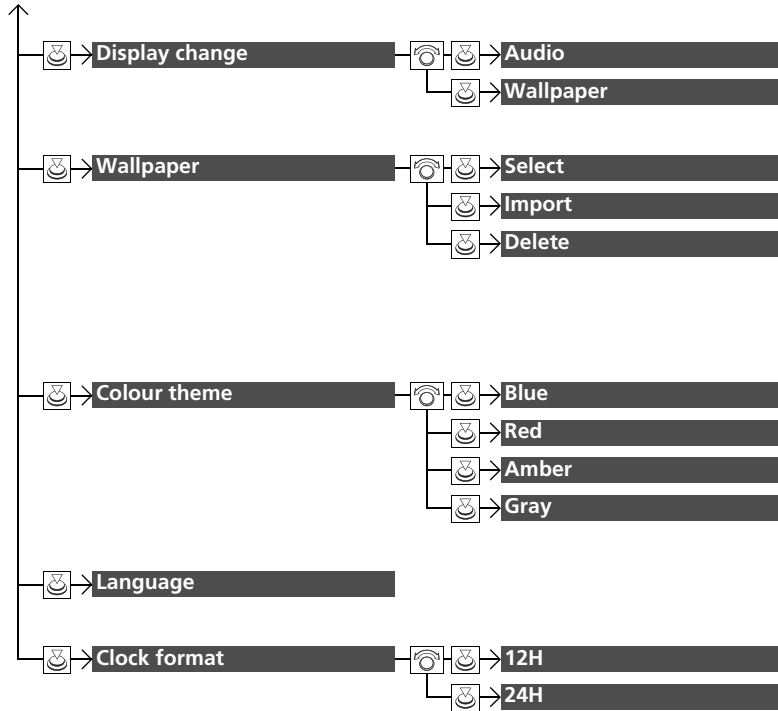

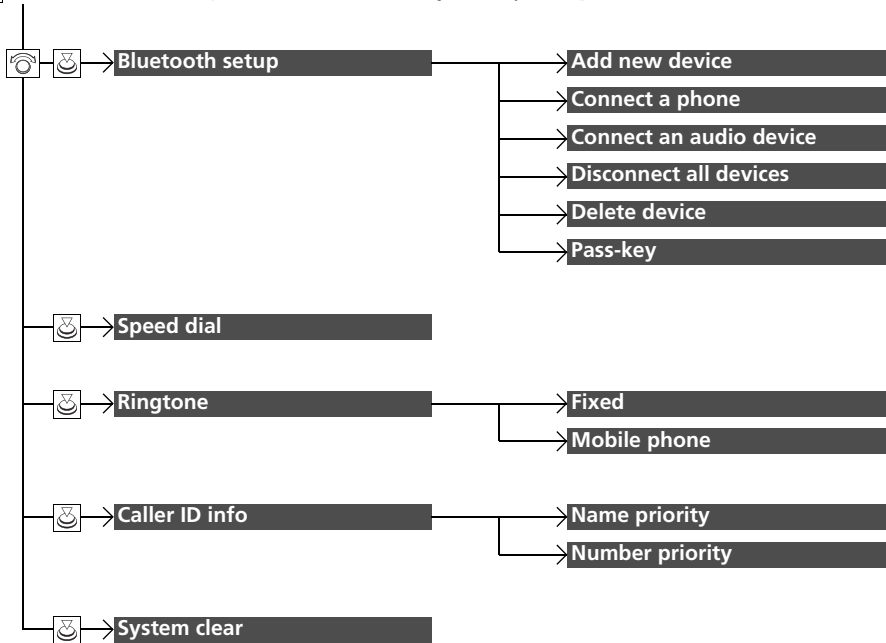

Press the  button and rotate  to select **Phone setup**, then press .



■ List of customizable options

Setup Group	Customizable Features	Description	Selectable Settings
Adjust clock		Adjust Clock.	—
		➤ Clock P. 139	
Sound	BAS		
	TRE		
	FAD	Adjusts the settings of the audio speaker's sound.	—
	BAL	➤ Adjusting the Sound P. 226	
	SVC		
Play mode	Normal play		
	CD/USB mode		
	Repeat one folder		
	CD/iPod/USB mode		
	Repeat one track		
	CD/USB mode		
	Random in folder		
	CD/USB mode		
	Random all	Selects a play mode.	—
	iPod mode	➤ How to Select a Play Mode P. 241, 244, 247	
	Shuffle album		
	iPod mode		
	Shuffle all		
CD/USB mode			
Scan folders			
CD/USB mode			
Scan tracks			

*1 : Default Setting

Setup Group	Customizable Features	Description	Selectable Settings	
Settings	AM/FM/DAB* mode	Selects the scan mode.  Scan P. 241, 247	—	
	RDS settings	Radio text	Turns on and off the radio text information.	On/Off ^{*1}
		AF	Turns on and off Alternative Frequency (AF).	On ^{*1} / Off
		REG	Turns on and off Regional Programme (REG).	On ^{*1} / Off
	DAB settings*	NEWS <small>Except AM/FM/DAB* mode</small>	Turns on and off to automatically to tune to the news programme.	On/Off ^{*1}
		Radio text	Turns on and off the radio text information.	On/Off ^{*1}
		DAB-Link	Selects whether the system automatically searches for the same station from Ensembles, and switches to it.	On ^{*1} / Off
		FM-Link	Selects whether the system finds the same station from an FM band, and automatically switches the band.	On ^{*1} / Off
	Bluetooth	Band select	Selects specific bands to reduce the time to update the lists, and search for a station.	Both ^{*1} / BandIII/L-Band
		Add new device	Pairs a new phone to HFT, edits and deletes a paired phone, and create a code for a paired phone.  Phone Setup P. 340	—
		Connect an audio device	Connects, disconnects or pairs a <i>Bluetooth</i> [®] Audio device to HFT.	—

*1: Default Setting

* Not available on all models

Setup Group	Customizable Features	Description	Selectable Settings
Settings	Display adjustment	Brightness	Changes the brightness of the audio/information screen. —
		Contrast	Changes the contrast of the audio/information screen. —
		Black level	Changes the black level of the audio/information screen. —
	Display change	Changes the display type. Audio*¹/Wallpaper	
	Wallpaper	Select	Changes the display type. Clock*¹/Image1/Image2/Image3
		Import	Imports an image file for a new wallpaper.  Wallpaper Setup P. 224 —
		Delete	Deletes an image file for a wallpaper. Image1*¹/Image2/Image3
	Colour theme	Changes the background colour of the audio/information screen. Blue*¹/Red/Amber/Grey	
	Language	Changes the display language. English*¹ /Other selectable language is shown on the screen.	
	Clock format	Selects the digital clock display from 12H to 24H. 12H*¹/24H	

*1: Default Setting

Setup Group	Customizable Features	Description	Selectable Settings
Phone setup	Add new device	Pairs a new phone to HFT. ➤ Phone Setup P. 340	—
	Connect a phone	Pairs a new phone or connects a paired phone to HFT. ➤ Phone Setup P. 340	—
	Connect an audio device	Connects a <i>Bluetooth</i> ® Audio device to HFT.	—
	Disconnect all devices	Disconnects a paired phone from HFT.	—
	Delete device	Deletes a paired phone.	—
	Pass-key	Inputs and changes a code for a paired phone.	—
	Speed dial	Edits, adds or deletes a speed dial entry. ➤ Speed Dial P. 349	—
	Ringtone	Selects the ring tone.	Fixed *1/ Mobile phone
	Caller ID info	Prioritizes the caller's name or phone number as the caller ID.	Name priority *1/ Number priority
	System clear	Cancels/Resets all customized items in the Phone setup group as default.	—

*1: Default Setting

Models with display audio system

Use the audio/information screen to customize certain features.

■ How to customize

While the vehicle is at a complete stop with the ignition switch in ON *1, select **Settings**, then select a setting item.

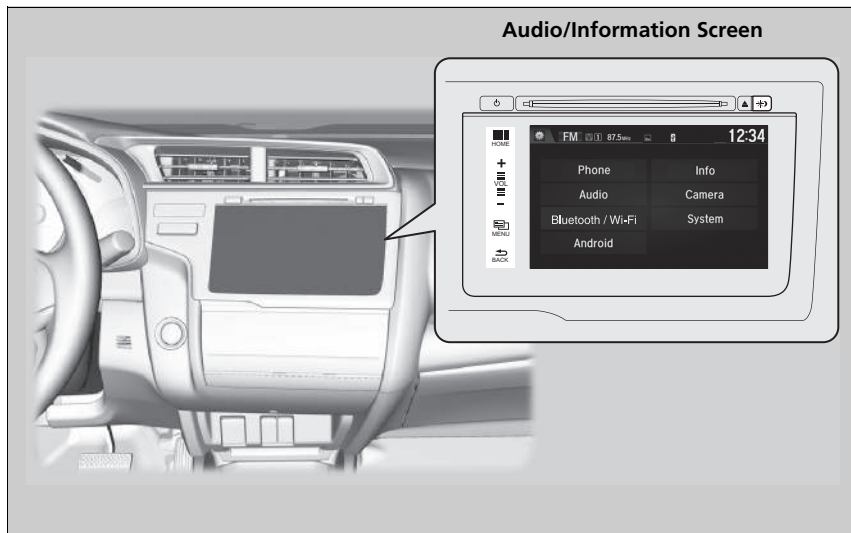

▶▶ Customized Features

When you customize settings:

- Make sure that the vehicle is at a complete stop.
- **Continuously variable transmission models**
Shift to **P**.
- **Manual transmission models**
Set the parking brake.

▶▶ How to customize

To customize other features, select **Settings**.

➔ **List of customizable options** P. 322

If you press and hold the  (power) button when resetting the system, it may restore the customized value to its default value depending on the setting items.

*1: Models with the keyless access system have an **ENGINE START/STOP** button instead of an ignition switch.

■ Customization flow

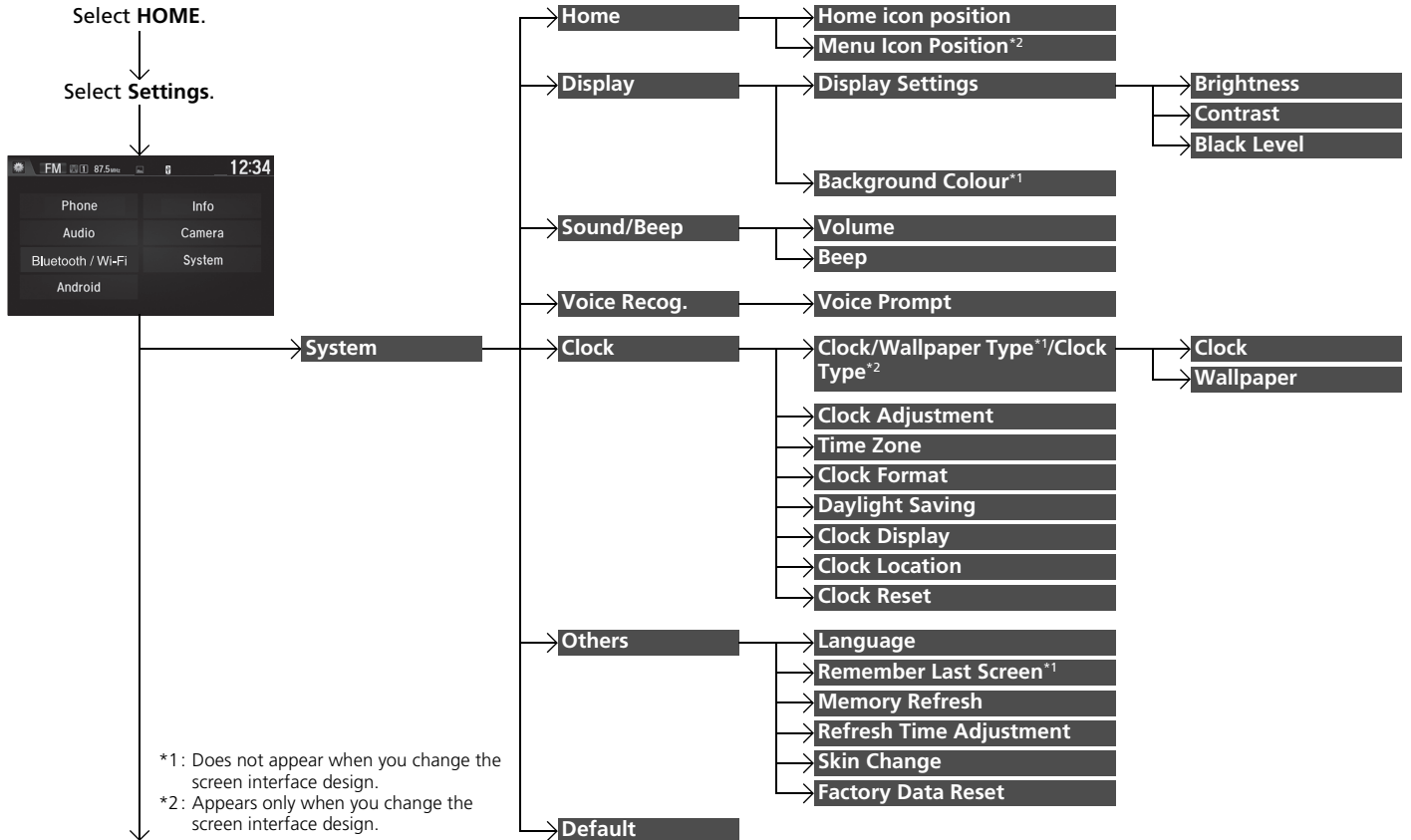

Features

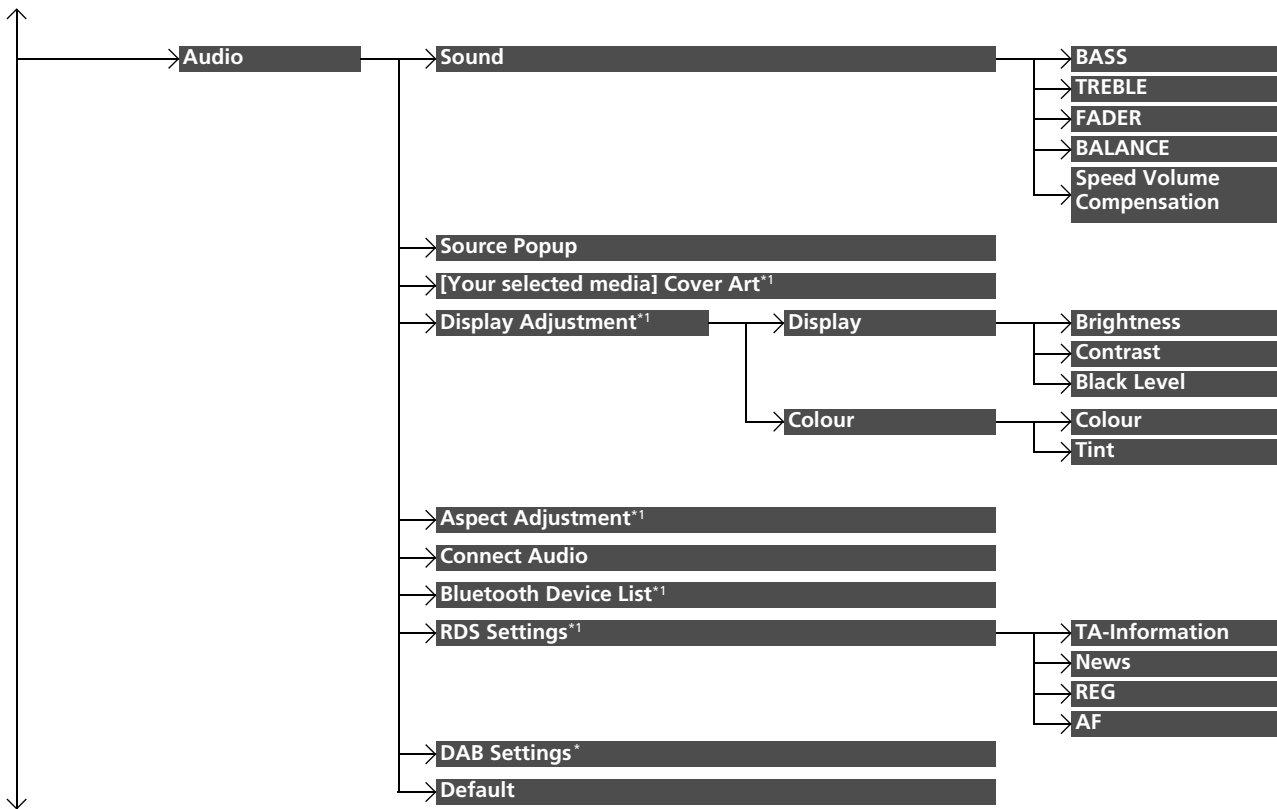

*1: May change depending on your currently selected source.

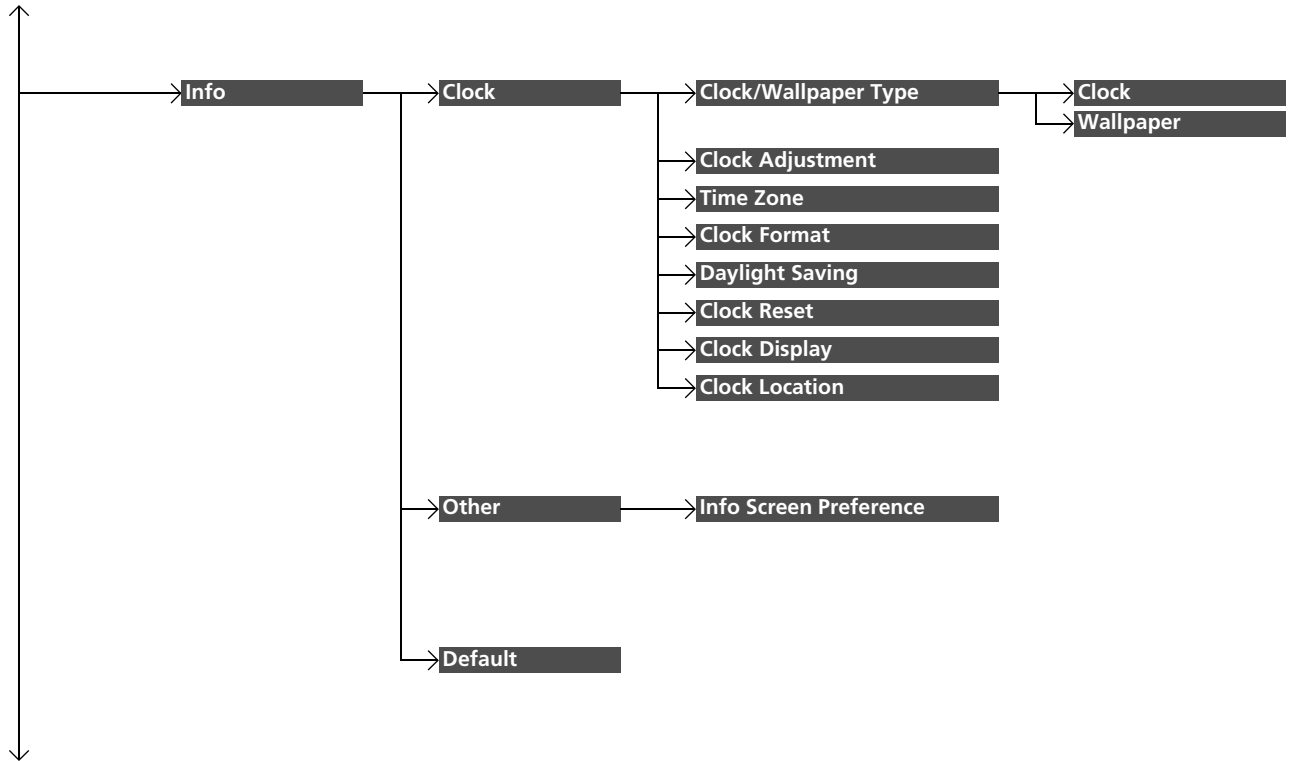

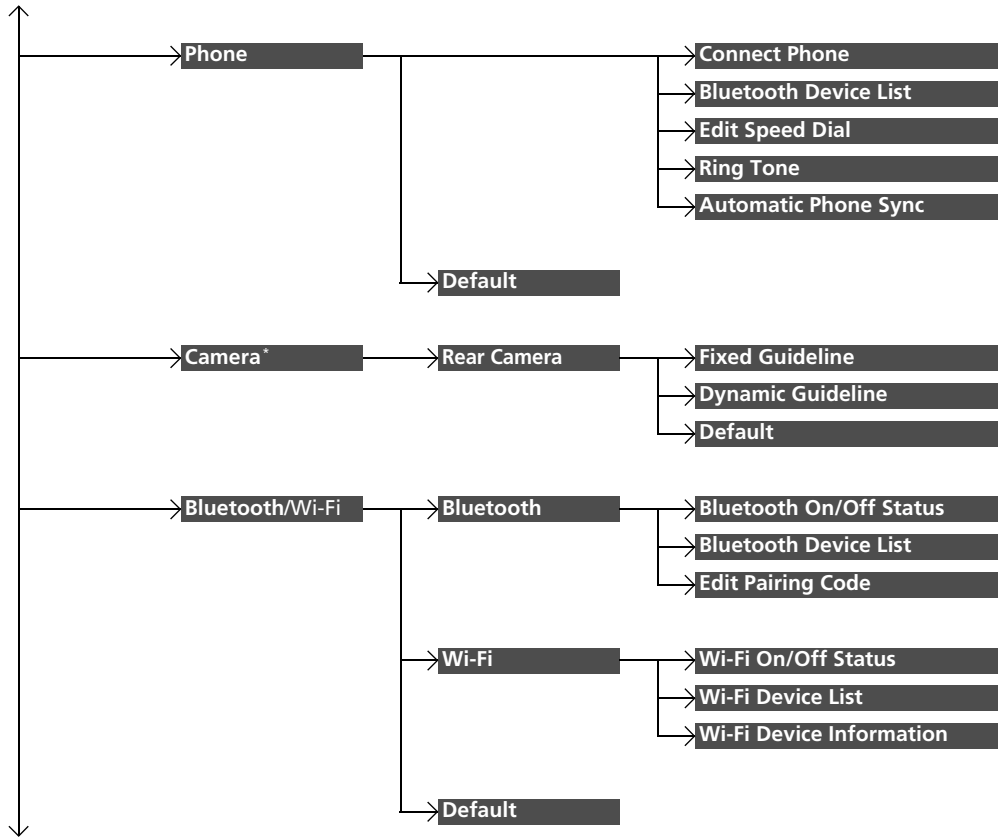

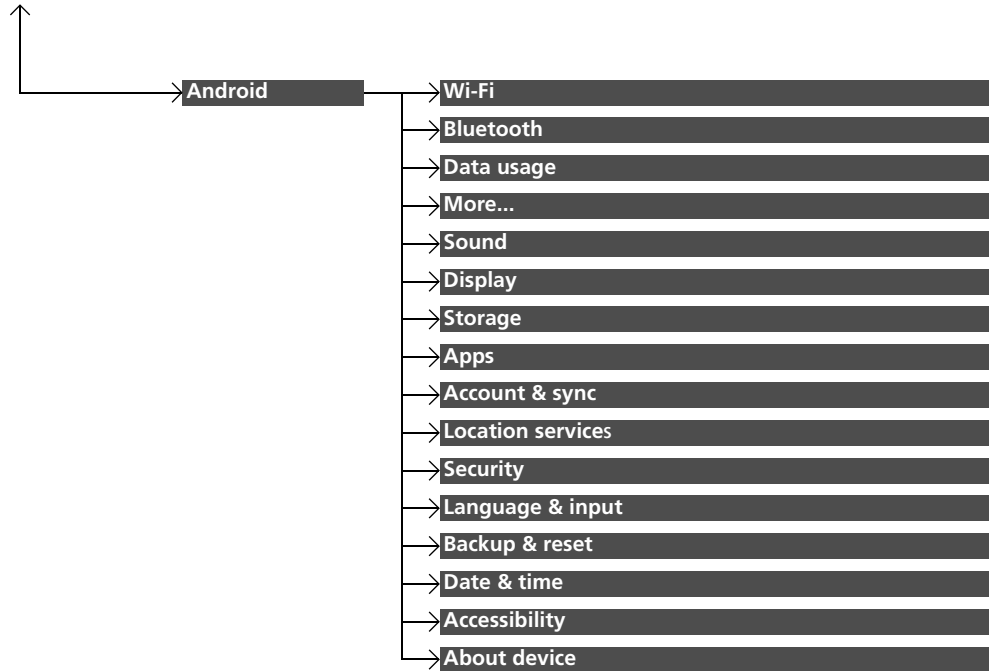

■ List of customizable options

Setup Group	Customizable Features	Description	Selectable Settings		
System	HOME	Home icon position	Changes the home screen icon layout.	—	
		Menu Icon Position ^{*3}	Changes the home screen icon layout.	—	
	Display	Display Settings	Brightness	Changes the brightness of the audio/information screen.	—
			Contrast	Changes the contrast of the audio/information screen.	—
			Black Level	Changes the black level of the audio/information screen.	—
			Background Colour ^{*2}	Changes the background colour of the audio/information screen	Blue ^{*1} / Amber/Red/Violet
	Sound/Beep	Volume	Changes the sound volume. Adjusts the guidance volume of the navigation system*.	0~6 ^{*1} ~ 11	
		Beep	Changes the beep volume.	OFF/1/2 ^{*1} / 3	
	Voice Recog.	Voice Prompt	Turns the voice prompt on and off.	On ^{*1} / Off	

*1 : Default Setting

*2 : Does not appear when you change the screen interface design.



*3 : Appears only when you change the screen interface design.

Setup Group	Customizable Features	Description	Selectable Settings	
System	Clock/ Wallpaper Type* ² / Clock Type* ³	Clock	Changes the clock display type.	Analog/Digital* ¹ /Small Digital/Off
		Wallpaper* ²	<ul style="list-style-type: none"> Changes the wallpaper type. Imports an image file for a new wallpaper. Deletes an image file for a wallpaper. 📄 Wallpaper Setup P. 256	Blank/Galaxy* ¹ /Metallic
	Clock Adjustment	Adjusts Clock. 📄 Clock P. 138	—	
	Time Zone	Changes the time zones.	WET/GMT* ¹	
	Clock Format	Selects the digital clock display from 12H to 24H.	12H* ¹ /24H	
	Daylight Saving	Adjusts the clock automatically when a summer time change occurs.	On* ¹ /Off	
	Clock Display	Selects whether the clock display comes on.	On* ¹ /Off	
	Clock Location	Changes the clock display layout.	Right upper* ¹ /Left upper/ Right lower/Left lower/Off	
Clock Reset	Resets the clock settings to the factory default.	—		

*1: Default Setting



*2: Does not appear when you change the screen interface design.

*3: Appears only when you change the screen interface design.

Setup Group	Customizable Features	Description	Selectable Settings
System	Others	Language	Changes the display language. English (United Kingdom)^{*1} : See other selectable languages on the screen.
		Remember Last Screen	Selects whether the device remembers the last screen. On/Off^{*1}
		Memory Refresh	Turns on the audio system automatically and restores the fragmentation of a memory when the ignition switch is LOCK <input type="checkbox"/> ^{*2} . On^{*1}/Off
		Refresh Time Adjustment	Sets the time for Memory Fresh . 00:00 ~ 02:00^{*1} ~ 23:59
		Skin Change	Changes the screen interface design. —
		Factory Data Reset	Resets all the settings to their factory default.  Defaulting All the Settings P. 332 Yes/No
	Default	Cancels/Resets all customized items in the System group as default. Yes/No	
Audio	Sound	Adjusts the settings of the audio speaker's sound  Adjusting the Sound P. 268	-6 ~ 0^{*1} ~ +6 (BASS and TREBLE), RR9~0^{*1}~FR9 (FADER), L9~0^{*1}~R9 (BALANCE), Off/Low/Mid^{*1}/High (SVC)
	Source Popup	Selects whether the list of selectable audio sources comes on or not when Audio is selected on the HOME screen. On/Off^{*1}	

*1 : Default Setting

*2 : Models with the keyless access system have an **ENGINE START/STOP** button instead of an ignition switch.

Setup Group	Customizable Features	Description	Selectable Settings	
Audio	CD, iPod or USB mode [Your selected media] Cover Art	Turns on and off the cover art display.	On^{*1}/Off	
	Display Adjustment	Brightness	 System P. 322	
		Contrast		
	Display Adjustment	Black Level		
		Colour	Colour	Changes the colour of the audio/information screen. —
			Tint	Changes the tint of the audio/information screen. —
	USB, HDMI™ mode Aspect Adjustment	Changes the aspect ratio and zoom settings of the audio/information screen.	Original (only USB)^{*1}/ Normal/Full^{*1}/Zoom	
	Bluetooth® Audio mode Connect Audio	Connects, disconnects or pairs a <i>Bluetooth®</i> Audio device to HFT.	—	
	Bluetooth® Audio mode Bluetooth Device List	Pairs a new phone to HFT, edits or deletes a paired phone.  Phone Setup P. 362	—	

*1: Default Setting

* Not available on all models

Setup Group	Customizable Features	Description	Selectable Settings
Audio	RDS Settings*		
	TA-Information	Turns on and off the traffic announcement function.	On/Off*¹
	News	Turns on and off the interruption news function.	On/Off*¹
	REG	Turns on and off the regional function.	On*¹/Off
	AF	Turns on and off the alternative frequency function.	On*¹/Off
	DAB Settings*		
	DAB-DAB Link	Selects whether the system automatically searches for the same station from Ensembles, and switches to it.	On*¹/Off
	DAB-FM Link	Selects whether the system finds the same station from an FM band, and automatically switches the band.	On*¹/Off
	Band select	Selects specific bands to reduce the time to update the lists, and search for a station.	BOTH*¹/BAND III/L-BAND
	Default	Cancels/Resets all customized items in the Audio group as default.	Yes/No

* 1 : Default Setting

Setup Group	Customizable Features	Description	Selectable Settings	
Info	Clock/ Wallpaper type^{*2/} Clock Type^{*3}	Clock <hr/> Wallpaper^{*2}		
		Clock Adjustment		
	Clock	Time Zone	📄 System P. 322	
		Clock Format		
		Daylight Saving		
		Clock Reset		
		Clock Display		
		Clock Location		
	Other	Info Screen Preference	Changes the Info screen type.	Info Top/Info Menu/Off^{*1}
	Default		Cancels/Resets all customized items in the Info group as default.	Yes/No

*1: Default Setting

*2: Does not appear when you change the screen interface design.

*3: Appears only when you change the screen interface design.

Setup Group	Customizable Features	Description	Selectable Settings
Phone	Connect Phone	Pairs a new phone to HFT, connects or disconnects a paired phone. ➤ Phone Setup P. 362	—
	Bluetooth Device List	Pairs a new phone to HFT, edits or deletes a paired phone. ➤ Phone Setup P. 362	—
	Edit Speed Dial	Edits, adds or deletes a speed dial entry. ➤ Speed Dial P. 368	—
	Ring Tone	Selects the ring tone.	Fixed/Mobile Phone *1
	Automatic Phone Sync	Sets a phonebook and call history data to be automatically imported when a phone is paired to HFT.	On/Off
	Default	Cancels/Resets all customized items in the Phone group as default.	Yes/No

*1: Default Setting

Setup Group	Customizable Features	Description	Selectable Settings
Camera*	Rear Camera	Fixed Guideline Selects whether the fixed guidelines come on on the rear camera monitor. ➤ Multi-View Rear Camera* P. 462	On*/Off
		Dynamic Guideline Selects whether the dynamic guidelines come on on the rear camera monitor. ➤ Multi-View Rear Camera* P. 462	On*/Off
		Default Cancels/Resets all customized items in the Rear Camera group as default.	Yes/No
Bluetooth /Wi-Fi	Bluetooth	Bluetooth On/Off Status Changes the <i>Bluetooth</i> ® status.	On*/Off
		Bluetooth Device List Pairs a new phone to HFT, edits or deletes a paired phone, or creates a security PIN. ➤ Phone Setup P. 362	—
		Edit Pairing Code Edits Pairing Code . ➤ To change the pairing code setting P. 363	Random/Fixed*1

*1: Default Setting

* Not available on all models

Setup Group	Customizable Features	Description	Selectable Settings
Bluetooth /Wi-Fi	Wi-Fi On/Off Status	Changes the Wi-Fi mode.	On*¹/Off
	Wi-Fi Device List	Connects, disconnects, or deletes the Wi-Fi device.	—
	Wi-Fi Device Information	Shows the Wi-Fi information of the device.	—
	Default	Cancels/Resets all customized items in the Bluetooth/Wi-Fi group as default.	Yes/No
Android	Wi-Fi	Shows the status of the Wi-Fi connection (On/Off) and adds new Wi-Fi networks.	On*¹/Off
	Bluetooth	Shows the status of the <i>Bluetooth</i> [®] connection (On/Off) and adds new <i>Bluetooth</i> [®] devices.	On*¹/Off
	Data usage	Shows the data usage of the system.	—
	More...	Adds VPN (Virtual Private Network).	—
	Sound	Adjusts the alarm volume and selects the favorite sound.	—
	Display	Sets up the wallpaper and changes the font size.	—

*1: Default Setting

Setup Group	Customizable Features	Description	Selectable Settings
Android	Storage	Shows the storage capacity of the system and the USB capacity.	—
	Apps	Shows the status of the installed apps.	—
	Account & sync	Adds the additional account information.	—
	Location services	Turn on/off the GPS setting before using apps.	—
	Security	Shows the security status of the system.	—
	Language & input	Changes the display language of the system and the input keyboard.	—
	Backup & reset	Resets the system.	—
	Date & time	Changes the date, the time zones, and the clock format.	—
	Accessibility	Changes the display font of the system and the voice guidance of the password.	—
	About device	Shows the status of the system, the Android version, the legal information, and so on.	—

*1: Default Setting

Defaulting All the Settings

Reset all the menu and customized settings as the factory defaults.

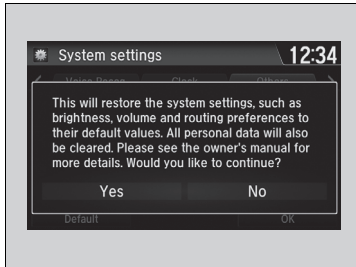

1. Select **HOME**.
2. Select **Settings**.
3. Select **System**.
4. Select the **Others** tab.
5. Select **Factory Data Reset**.
 - The confirmation message will appear.
6. Select **Yes** to reset the settings.
7. Select **Yes** again to reset the settings.
 - The confirmation message will appear. Select **OK**.

►► Defaulting All the Settings

When you transfer the vehicle to a third party, reset all settings to default and delete all personal data.

The following settings will be reset:

- Audio preset settings
- Phonebook entries
- Other display and personal settings.

Hands-Free Telephone System

Models with colour audio system

The Hands-Free Telephone (HFT) System allows you to place and receive phone calls using your vehicle's audio system, without handling your mobile phone.

Using HFT

HFT Buttons

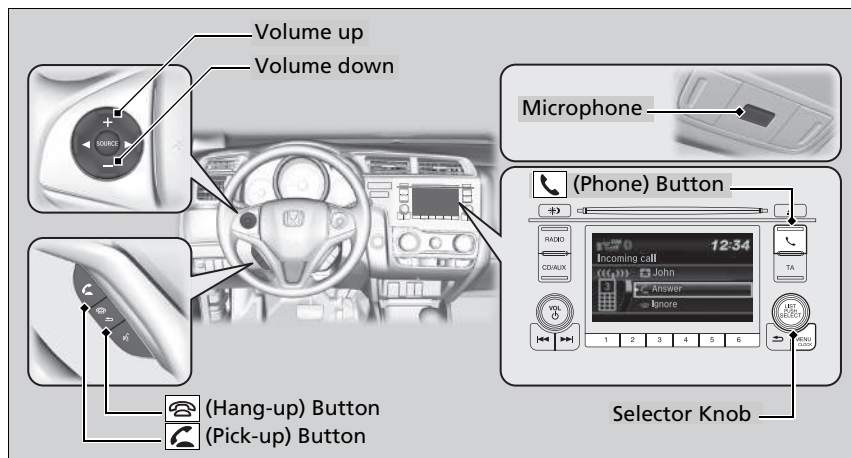

Hands-Free Telephone System

To use HFT, you need a *Bluetooth*-compatible mobile phone. For a list of compatible phones, pairing procedures, and special feature capabilities, ask a dealer or your local Honda.

Voice control tips

- Aim the vents away from the ceiling and close the windows, as noise coming from them may interfere with the microphone.
- To change the volume level, use the audio system's volume knob or the remote audio controls on the steering wheel.

If you receive a call while using the audio system, the system resumes its operation after ending the call.



Up to 20 speed dial entries can be stored. If there is no entry in the system, Speed dial is disabled.

➤ **Speed Dial** P. 349

Up to 20 call histories can be stored. If there is no call history, Call history is disabled.

Continued

 **(Phone) button:** Press to go directly to the **Phone** screen.

LIST/SELECT (Selector) knob: Rotate  to select an item on the screen, then press .

 **(Pick-up) button:** Press to go directly to the **Phone** screen or to answer an incoming call.

 **(Hang-up) button:** Press to end a call.

HFT Status Display

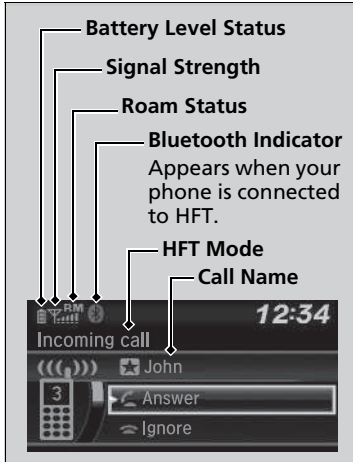

The audio/information screen notifies you when there is an incoming call.

Limitations for Manual Operation

Certain manual functions are disabled or inoperable while the vehicle is in motion. You cannot select a grayed-out option until the vehicle is stopped.

Hands-Free Telephone System

Bluetooth® Wireless Technology

The *Bluetooth*® word mark and logos are registered trademarks owned by Bluetooth SIG, Inc., and any use of such marks by Honda Motor Co., Ltd., is under licence. Other trademarks and trade names are those of their respective owners.

HFT Limitations

An incoming call on HFT will interrupt the audio system when it is playing. It will resume when the call is ended.

See the following URLs for Declaration of conformity (DoC) of Hands Free Telephone:
<http://www.ptc.panasonic.eu/>

HFT Status Display

The information that appears on the audio/information screen varies between phone models.

You can change the system language.

▶ **Customized Features** P. 307

HFT Menu

The ignition switch must be in ACCESSORY **I** or ON **II** to use the system.

HFT Menu
 To use HFT, you must first pair your *Bluetooth*-compatible mobile phone to the system while the vehicle is parked.
 Some functions are limited while driving.

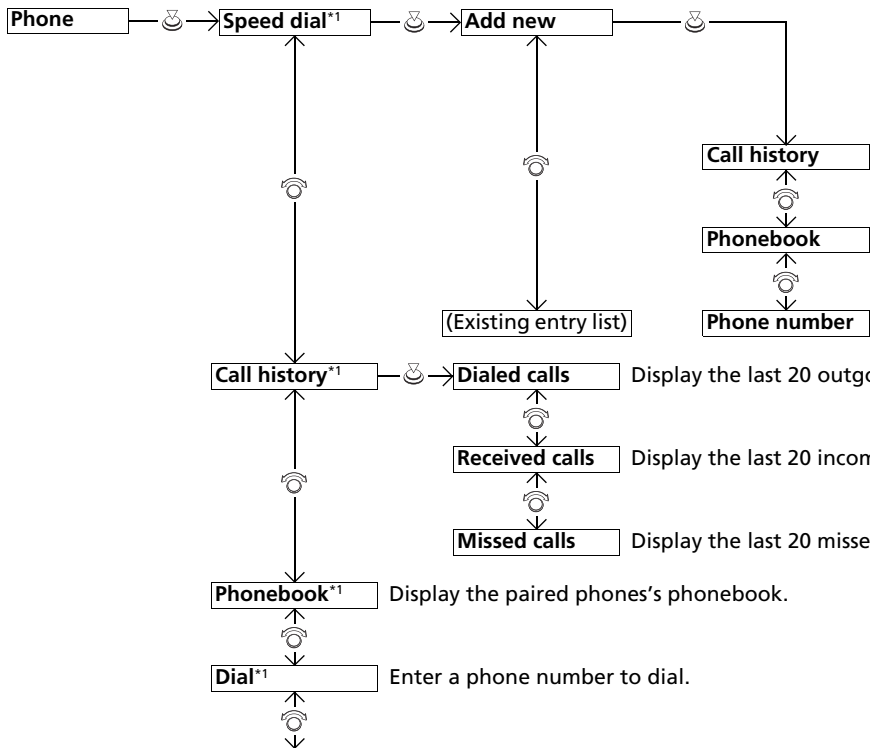
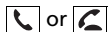

Select a phone number from the call history to store as a speed dial number.

Select a phone number from the phonebook to store as a speed dial number.

Enter a phone number to store as a speed dial number.

Display the last 20 outgoing calls.

Display the last 20 incoming calls.

Display the last 20 missed calls.

Display the paired phones's phonebook.

Enter a phone number to dial.

*1 : Appears only when a phone is connected to the system.

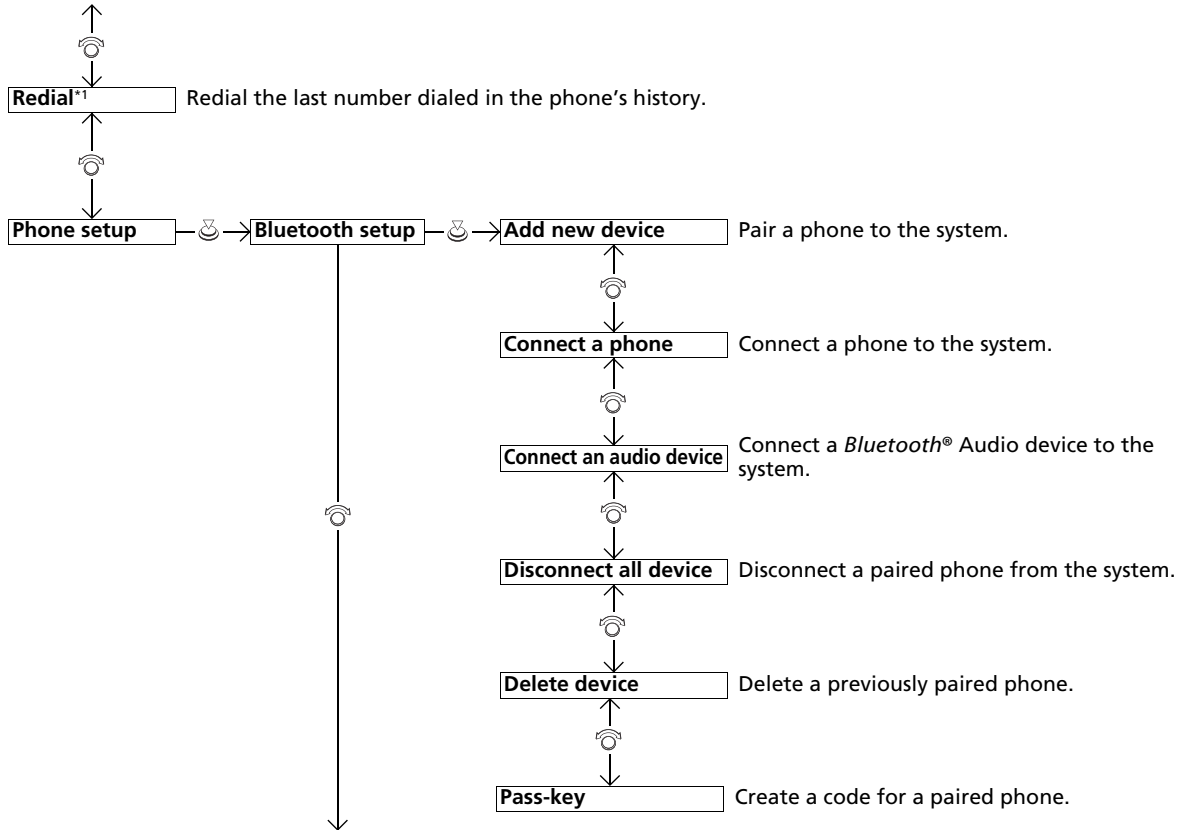

*1: Appears only when a phone is connected to the system.

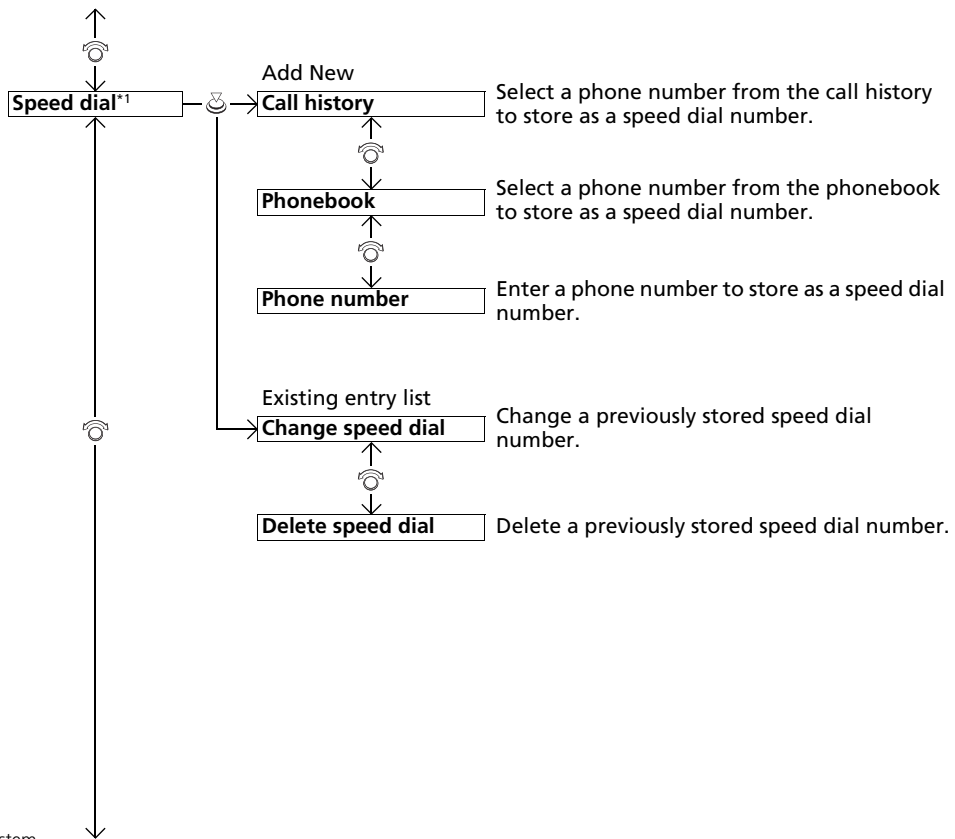

*1: Appears only when a phone is connected to the system.

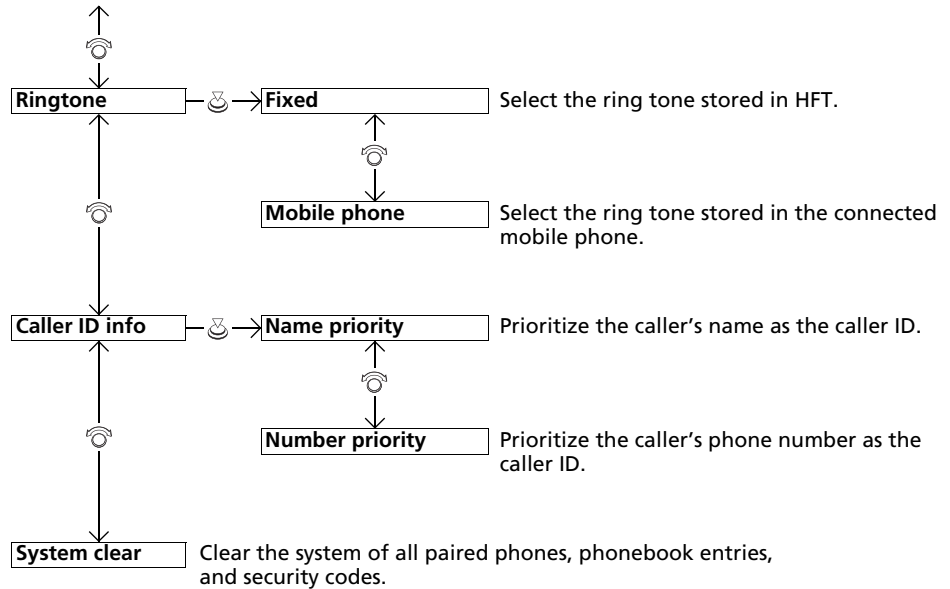

Phone Setup

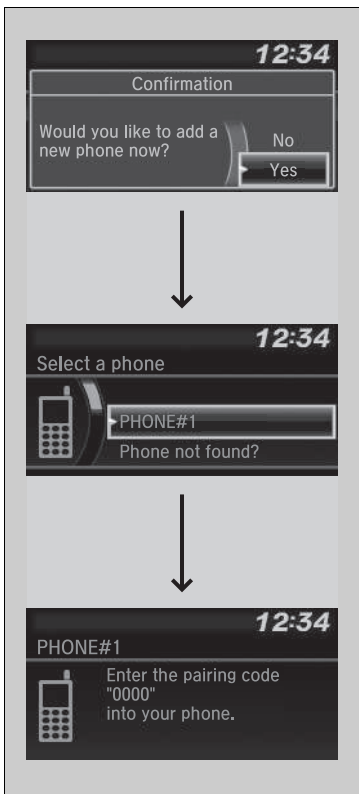

■ To pair a mobile phone (No phone has been paired to the system)

1. Press the button or the button.
2. Rotate to select **Yes**, then press .
3. Make sure your phone is in search or discoverable mode, then press .
 - ▶ HFT automatically searches for a *Bluetooth*® device.
4. When your phone appears on the list, select it by pressing .
 - ▶ If your phone doesn't appear, select **Phone not found?** and search for *Bluetooth*® devices using your phone. From your phone, select **Honda HFT**.
5. The system gives you a pairing code on the audio/information screen.
 - ▶ Confirm if the pairing code on the screen and your phone match. This may vary by phone.
6. A notification appears on the screen if pairing is successful.

Phone Setup

Your *Bluetooth*-compatible phone must be paired to the system before you can make and receive hands-free calls.

Phone Pairing Tips:

- You cannot pair your phone while the vehicle is moving.
- Up to six phones can be paired.
- Your phone's battery may drain faster when it is connected to the system.
- If your phone is not ready for pairing or not found by the system within three minutes, the system will time out and return to idle.









Once you have paired a phone, you can see it displayed on the screen with one or two icons on the right side.

These icons indicate the following:

- : The phone can be used with HFT.
- : The phone is compatible with *Bluetooth*® Audio.



■ **To pair a mobile phone (when a phone has already been paired to the system)**

1. Press the  button or the  button.
 - ▶ If a prompt appears asking to connect to a phone, select **No** and proceed with step 2.
2. Rotate  to select **Phone setup**, then press .
3. Rotate  to select **Bluetooth setup**, then press .
4. Rotate  to select **Add New device**, then press .
 - ▶ The screen changes to device list.
5. Rotate  to select **Add new**, then press .

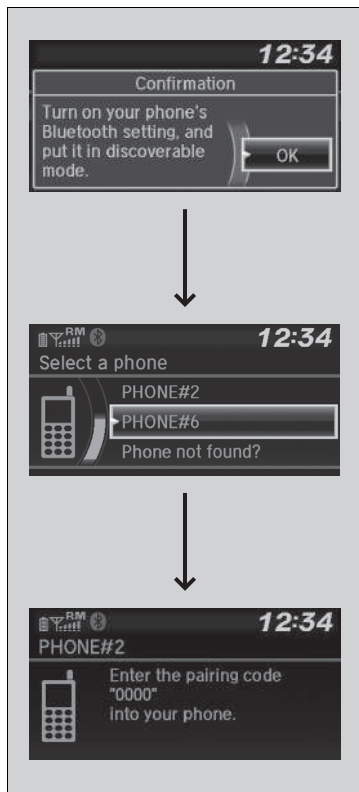

6. Make sure your phone is in search or discoverable mode, then press .
 - ▶ HFT automatically searches for a *Bluetooth*® device.

7. When your phone appears on the list, select it by pressing .
 - ▶ If your phone does not appear, select **Phone not found?** and search for *Bluetooth*® devices using your phone. From your phone, select **Honda HFT**.

8. The system gives you a pairing code on the audio display.
 - ▶ Confirm if the pairing code on the screen and your phone match. This may vary by phone.

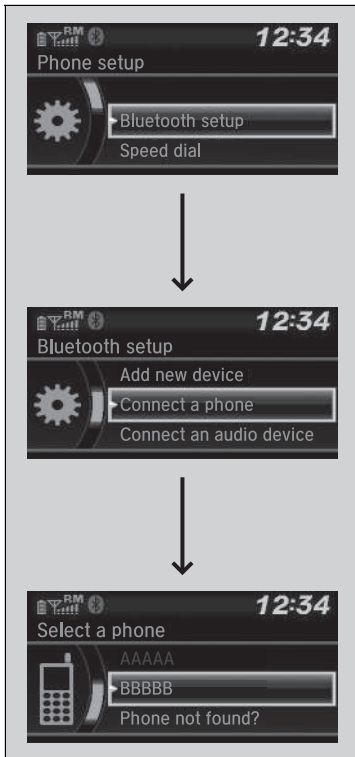

■ To Change the currently paired phone

1. Press the button or the button.
2. Rotate to select **Phone setup**, then press .
3. Rotate to select **Bluetooth setup**, then press .
4. Rotate to select **Connect a phone**, then press .
 - ▶ The screen changes to a device list.
5. Rotate to select a desired device name, then press .
 - ▶ The system disconnects the connected phone and starts searching for another paired phone.

Continued

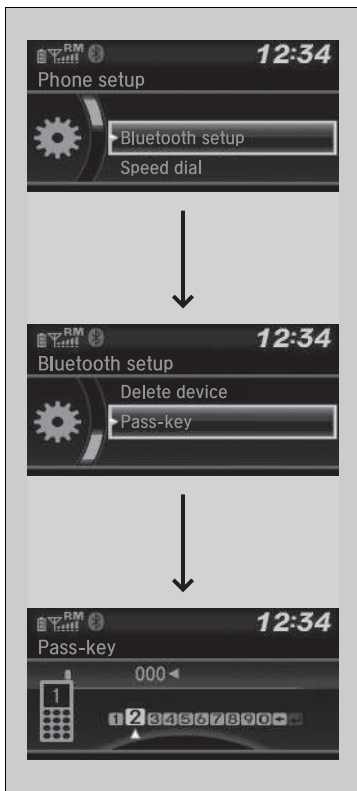

■ **To change the pairing code setting**

1. Press the button or the button.
2. Rotate to select **Phone setup**, then press .
3. Rotate to select **Bluetooth setup**, then press .
4. Rotate to select **Pass-key**, then press .
5. Input a new pairing code, then press .

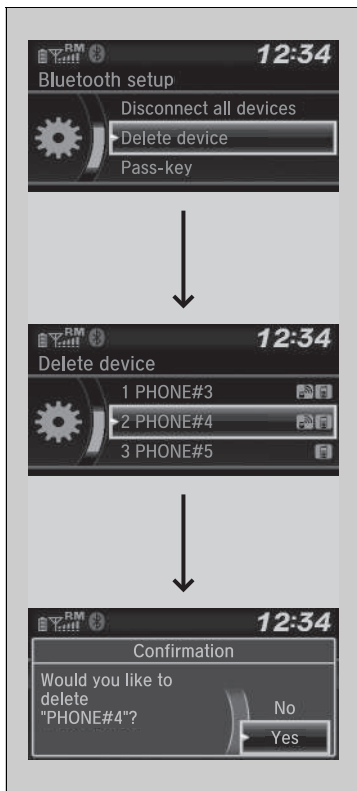

■ To delete a paired phone

1. Press the button or the button.
2. Rotate to select **Phone setup**, then press .
3. Rotate to select **Bluetooth setup**, then press .
4. Rotate to select **Delete device**, then press .
 - ▶ The screen changes to a device list.
5. Rotate to select a phone you want to delete, then press .
6. A confirmation message appears on the screen. Rotate to select **Yes**, then press .

■ Ring Tone

You can change the ring tone setting.



1. Press the button or the button.
2. Rotate to select **Phone setup**, then press .
3. Rotate to select **Ringtone**, then press .
4. Rotate to select **Fixed** or **Mobile phone**, then press .

■ Caller's ID Information

You can select a caller's information to be displayed when you have an incoming call.

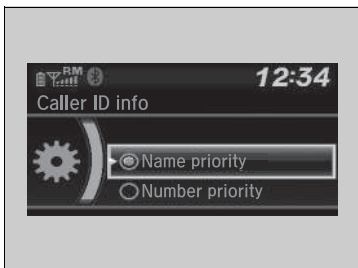

1. Press the button or the button.
2. Rotate to select **Phone setup**, then press .
3. Rotate to select **Caller ID info**, then press .
4. Rotate to select a mode you want, then press .

▶▶ Ring Tone

Fixed: The fixed ring tone sounds from the speakers.

Mobile phone: The ring tone stored in the connected mobile phone sounds from the speakers.

▶▶ Caller's ID Information

Name priority: A caller's name is displayed if it is stored in the phonebook.

Number priority: A caller's phone number is displayed.

To Clear the System

Pairing codes, paired phones, all speed dial entries, all call history data, and all imported phonebook data are erased.

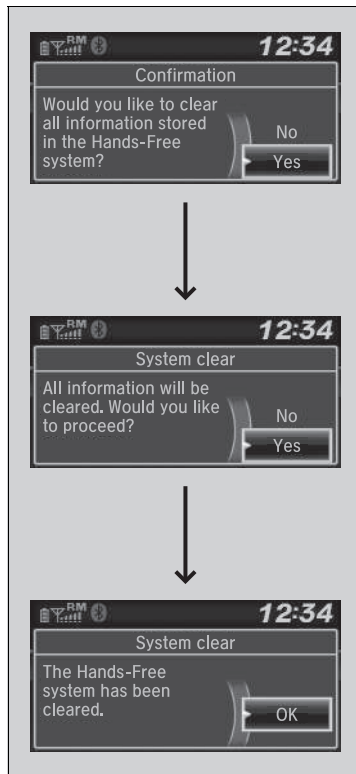

1. Press the button or the button.
2. Rotate to select **Phone setup**, then press .
3. Rotate to select **System clear**, then press .
4. Rotate to select **Yes**, then press .
5. A confirmation message appears on the screen. Rotate to select **Yes**, then press .
6. A confirmation appears on the screen. Press .

Continued

■ Automatic Import of Mobile Phonebook and Call History

When your phone is paired, the contents of its phonebook and call history are automatically imported to the system.



▶ Automatic Import of Mobile Phonebook and Call History

When you select a person from the list in the mobile phonebook, you can see up to three category icons. The icons indicate what types of numbers are stored for that name.

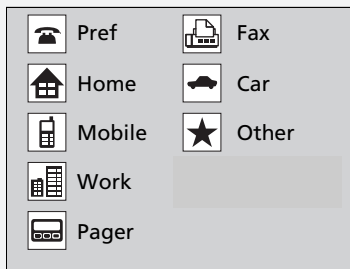

If a name has four or more numbers, ... appears instead of category icons.

On some phones, it may not be possible to import the category icons to the system.

The phonebook is updated after every connection. Call history is updated after every connection or call.

Speed Dial

Up to 20 speed dial numbers can be stored per phone.

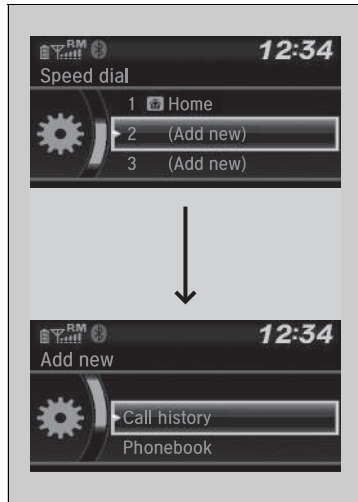

To store a speed dial number:

1. Press the button or the button.
2. Rotate to select **Speed dial**, then press .
3. Rotate to select **Add new**, then press .
4. Rotate to select a place to choose a number from, then press .
 - From **Call history**:
 - ▶ Select a number from the call history.
 - From **Phonebook**:
 - ▶ Select a number from the connected cell phone's imported phonebook.
 - From **Phone number**:
 - ▶ Input the number manually.

Speed Dial

You can use the audio preset buttons during a call to store a speed dial number:

1. Press and hold the desired audio preset button during a call.
2. The contact information for the active call will be stored for the corresponding speed dial.

Continued



■ **To edit a speed dial**

1. Press the button or the button.
2. Rotate to select **Phone setup**, then press .
3. Rotate to select **Speed dial**, then press .
4. Select an existing speed dial entry.
5. Rotate to select **Change speed dial**, then press .
6. Select a new speed dial number, then press .



■ **To delete a speed dial number**

1. Press the button or the button.
2. Rotate to select **Phone setup**, then press .
3. Rotate to select **Speed dial**, then press .
4. Select an existing speed dial entry.
5. Rotate to select **Delete speed dial**, then press .
 - ▶ A confirmation message appears on the screen. Rotate to select **Yes**, then press .

Making a Call

You can make calls by inputting any phone number, or by using the imported phonebook, call history, speed dial entries, or redial.



▶▶ Making a Call

The maximum range between your phone and vehicles is 10 metres (30 feet).

Once a call is connected, you can hear the voice of the person you are calling through the audio speakers.

Continued

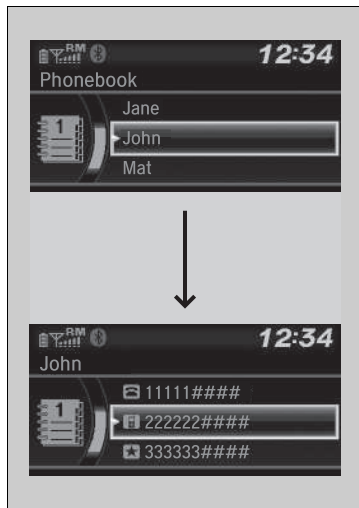

■ **To make a call using the imported phonebook**

When your phone is paired, the contents of its phonebook are automatically imported to the system.

1. Press the button or the button.
 2. Rotate to select **Phonebook**, then press .
 3. The phonebook is stored alphabetically. Rotate to select the initial, then press .
 4. Rotate to select a name, then press .
 5. Rotate to select a number, then press .
- ▶ Dialing starts automatically.

■ **To make a call using a phone number**

1. Press the button or the button.
 2. Rotate to select **Dial**, then press .
 3. Rotate to select a number, then press .
 4. Rotate to select , then press .
- ▶ Dialing starts automatically.

⌘ **To make a call using the imported phonebook**

This function is disabled while the vehicle is moving.

⌘ **To make a call using a phone number**

This function is disabled while the vehicle is moving.



■ To make a call using redial

1. Press the button or the button.
2. Rotate to select **Redial**, then press .
 - ▶ Dialing starts automatically.

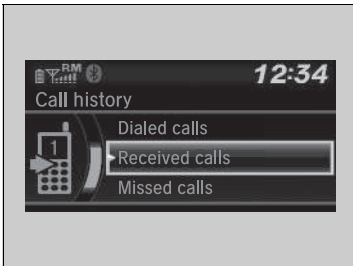

■ To make a call using the call history

Call history is stored by **Dialed calls**, **Received calls**, and **Missed calls**.

1. Press the button or the button.
2. Rotate to select **Call history**, then press .
3. Rotate to select **Dialed calls**, **Received calls**, or **Missed calls**, then press .
4. Rotate to select a number, then press .
 - ▶ Dialing starts automatically.

☒ To make a call using redial

Press and hold the button to redial the last number dialed in your phone's call history.

☒ To make a call using the call history

The call history appears only when a phone is connected to the system, and displays the last 20 dialed, received, or missed calls.

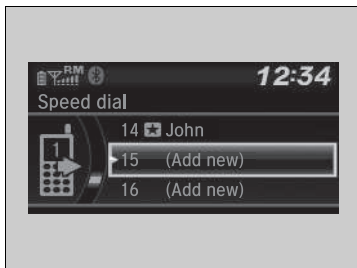

■ To make a call using a speed dial entry

1. Press the button or the button.
2. Rotate to select **Speed dial**, then press .
3. Rotate to select a number, then press .
 - ▶ Dialing starts automatically.

▶▶ To make a call using a speed dial entry

On the **Phone** screen, the first six speed dials on the list can be directly selected by pressing the corresponding audio preset buttons (1-6).

■ Receiving a Call

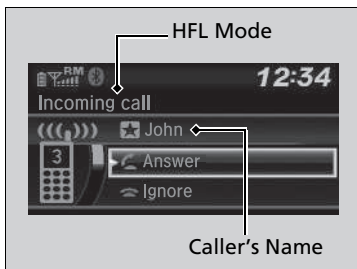

When there is an incoming call, an audible notification sounds and the **Incoming call** screen appears.

- Press the button to answer the call.
 Press the button to decline or end the call.

▶▶ Receiving a Call

Call Waiting

Press the button to put the current call on hold to answer the incoming call.

Press the button again to return to the current call.

Select **Ignore** to ignore the incoming call if you do not want to answer it.

Press the button if you want to hang up the current call.

You can select the icons on the audio/information screen instead of the and buttons. Rotate to select the icon, then press .

Options During a Call

The following options are available during a call.



Swap call: Put the current call on hold to answer the incoming call.

Mute: Mute your voice.

Transfer call: Transfer a call from the system to your phone.

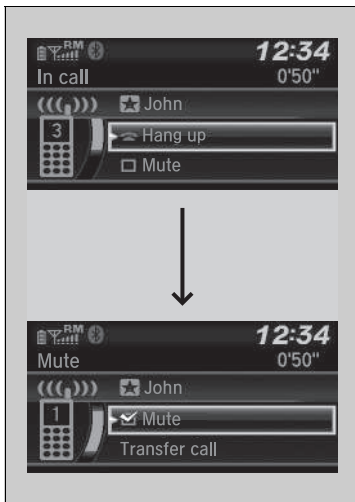
Dial tones: Send numbers during a call. This is useful when you call a menu-driven phone system.



1. To view the available options, press the  button.
2. Rotate  to select the option, then press .
 - ▶ The check box is checked when **Mute** is selected. Select **Mute** again to turn it off.

Options During a Call

Dial tones: Available on some phones.

Models with display audio system

HFT (Hands-Free Telephone) System allows you to place and receive phone calls using your vehicle's audio system, without handling your mobile phone.

Using HFT

HFT Buttons

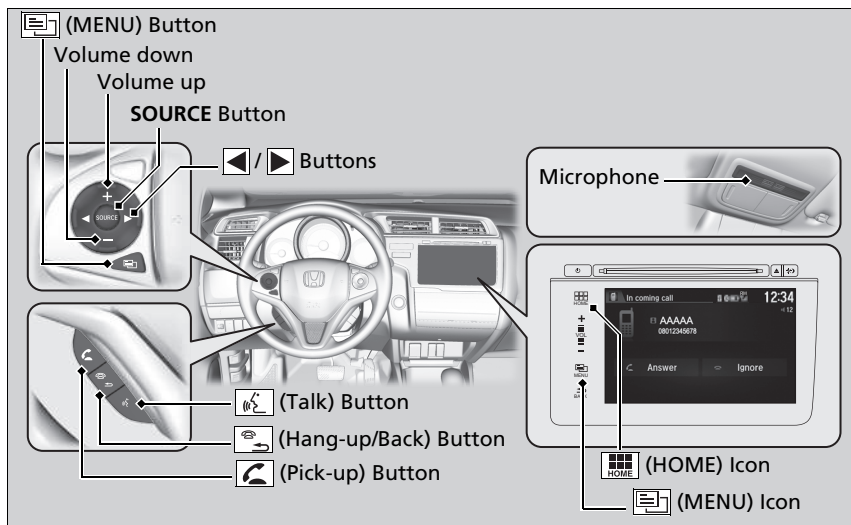

(Pick-up) button: Press to go directly to the **Phone** screen, or to answer an incoming call.

(Hang-up/Back) button: Press to end a call, go back to the previous command, or cancel a command.

Hands-Free Telephone System

To use HFT, you need a *Bluetooth*-compatible mobile phone. For a list of compatible phones, pairing procedures, and special feature capabilities, ask a dealer or your local Honda.

To use the system, the **Bluetooth On/Off Status** setting must be **On**.

➤ **Customized Features** P. 316



Voice control tips

- Aim the vents away from the ceiling and close the windows, as noise coming from them may interfere with the microphone.
- Press and release the  button when you want to call a number using a stored voice tag. Speak clearly and naturally after a beep.
- If the microphone picks up voices other than yours, the command may be misinterpreted.
- To change the volume level, select the audio system's **VOL** (Volume) or use the remote audio controls on the steering wheel.

Up to 6 speed dial entries can be display among a total of 20 that can be entered. If there is no entries in the system, Speed Dial is disabled.

➤ **Speed Dial** P. 368

Up to six call histories can be displayed. If there is no call histories, Call History is disabled.

-  **(Talk) button:** Press to call a number with a stored voice tag.
-  **(Menu) button:** Press to display **Speed Dial**, **Call History**, or **Redial** on the **Phone** screen.
-  **button:** Press to select an item displayed on the **Phone** screen.
- SOURCE button:** Press to call a number listed in the selected item on the **Phone** screen.

To go to the **Phone Menu** screen:

1. Select **HOME**.
2. Select **Phone** to switch the display to the **Phone** screen.
3. Select **MENU**.

■ HFT Status Display

The audio/information screen notifies you when there is an incoming call.

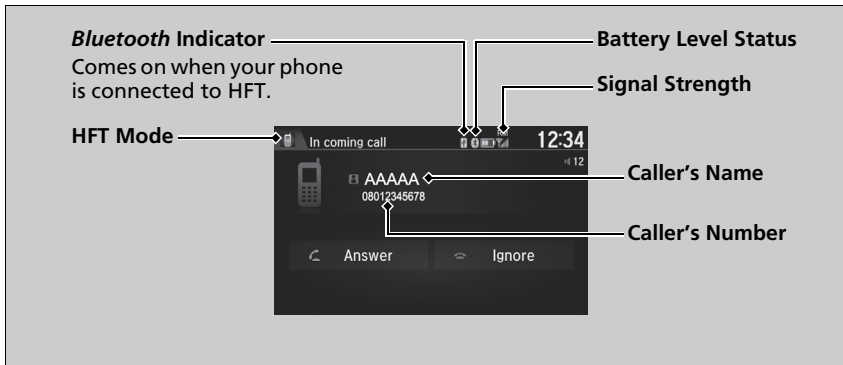

Continued

▶▶ Hands-Free Telephone System

Bluetooth® Wireless Technology

The *Bluetooth*® word mark and logos are registered trademarks owned by *Bluetooth SIG, Inc.*, and any use of such marks by Honda Motor Co., Ltd., is under licence. Other trademarks and trade names are those of their respective owners.

HFT Limitations

An incoming call on HFT will interrupt the audio system when it is playing. It will resume when the call is ended.

▶▶ HFT Status Display

The information that appears on the audio/information screen varies between phone models.

You can change the system language.

 **Customized Features** P. 316

■ Limitations for Manual Operation

Certain manual functions are disabled or inoperable while the vehicle is in motion. You cannot select a grayed-out option until the vehicle is stopped.

Only previously stored speed dial entries with voice tags, phonebook names, or numbers can be called using voice commands while the vehicle is in motion.

➤ **Speed Dial** P. 368

HFT Menus

The ignition switch must be in ACCESSORY  or ON *1 to use the system.

■ Phone settings screen



1. Select **HOME**.
2. Select **Settings**.
3. Select **Phone**.

 **HFT Menu**

To use HFT, you must first pair your *Bluetooth*-compatible mobile phone to the system while the vehicle is parked.

Some functions are limited while driving.

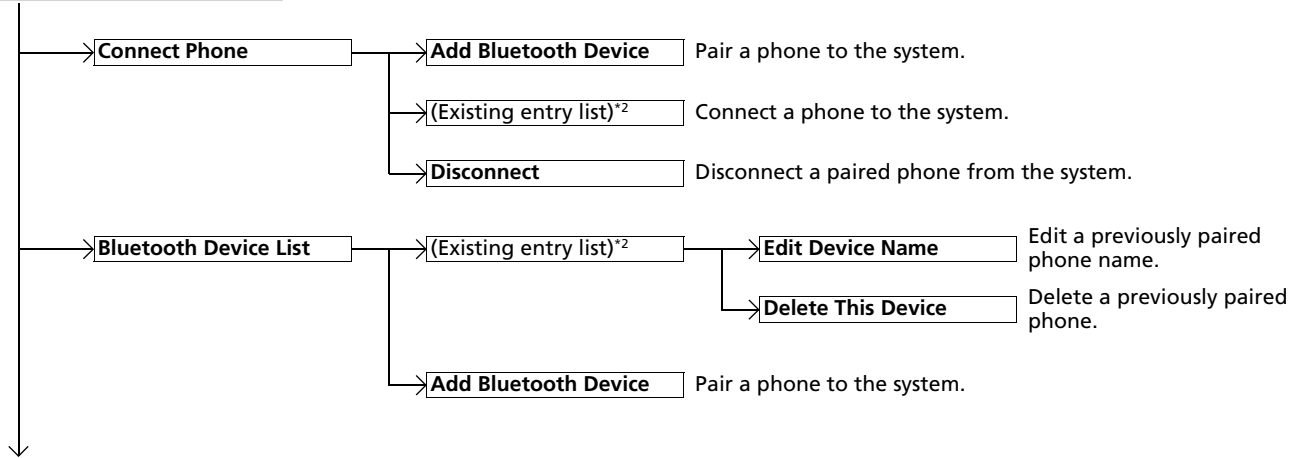

*1: Models with the keyless access system have an **ENGINE START/STOP** button instead of an ignition switch.

*2: Appears only when a phone is connected to the system.

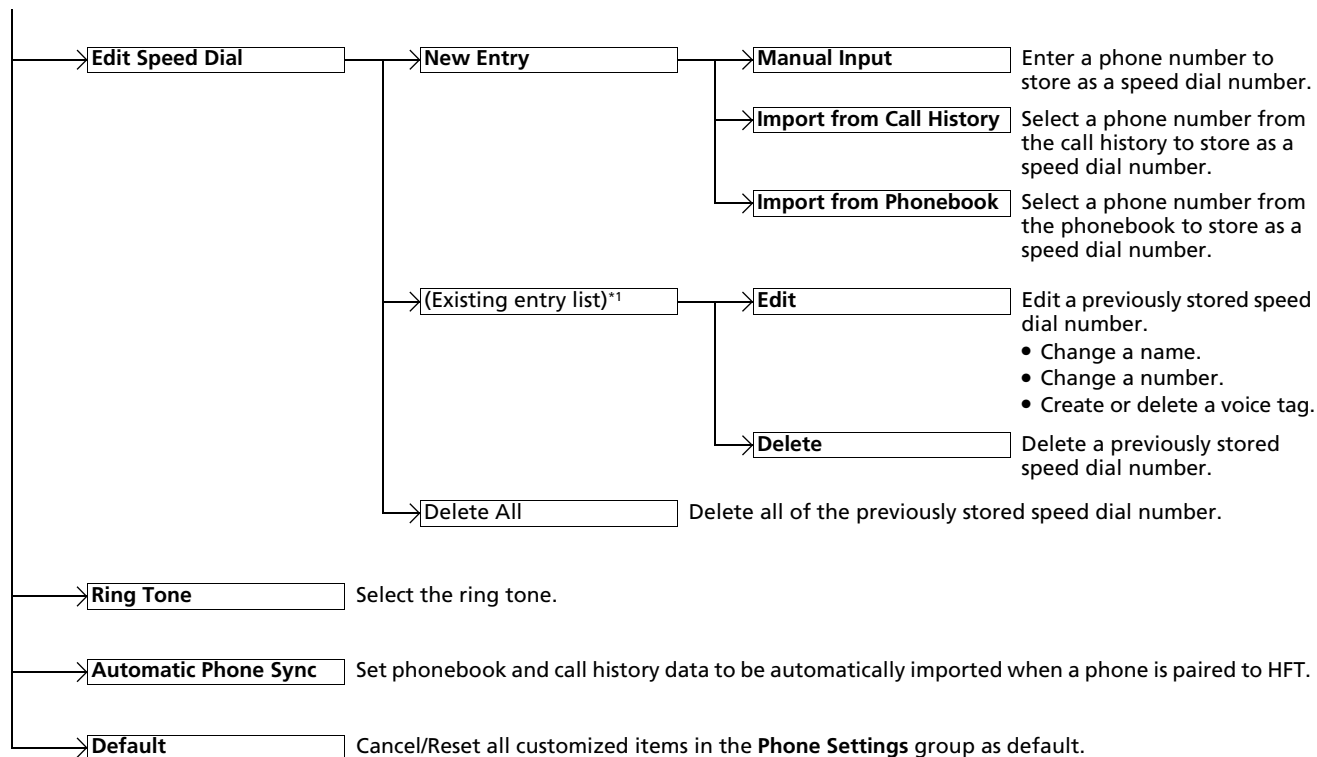

*1: Appears only when a phone is connected to the system.

■ Phone menu screen

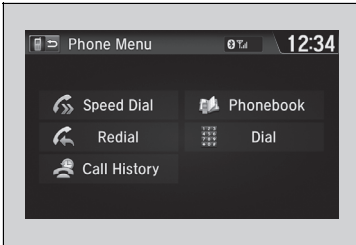

1. Press , or select **HOME**, then select **Phone**.
2. Press (MENU) on the steering wheel, or select **MENU**.

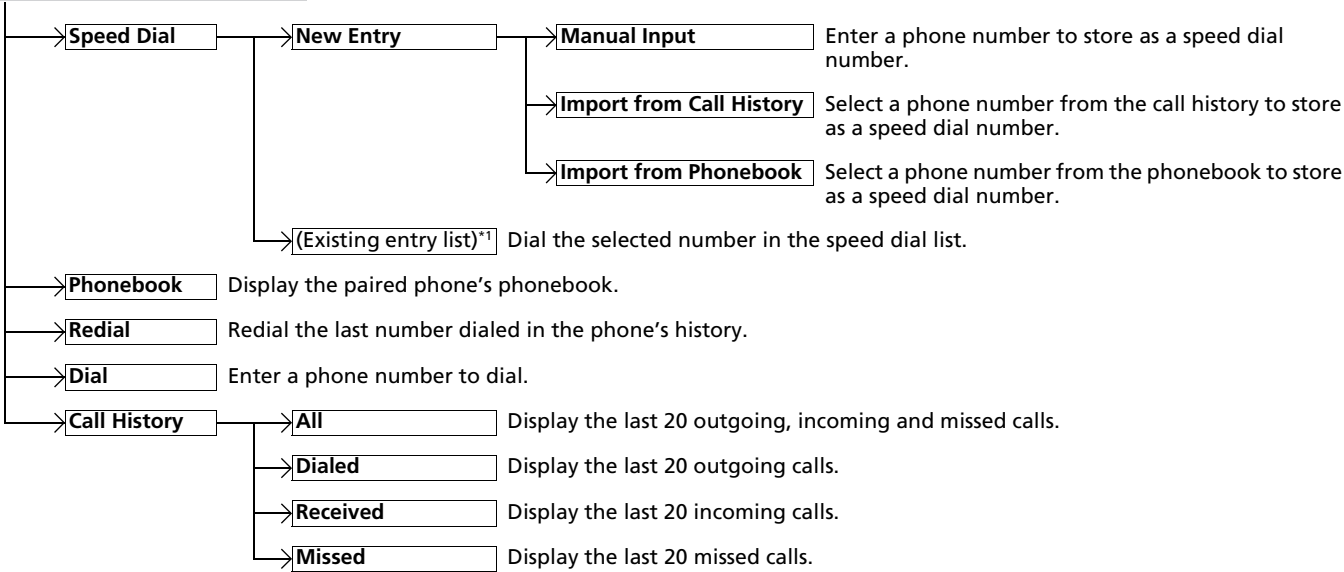

*1: Appears only when a phone is connected to the system.

Phone Setup

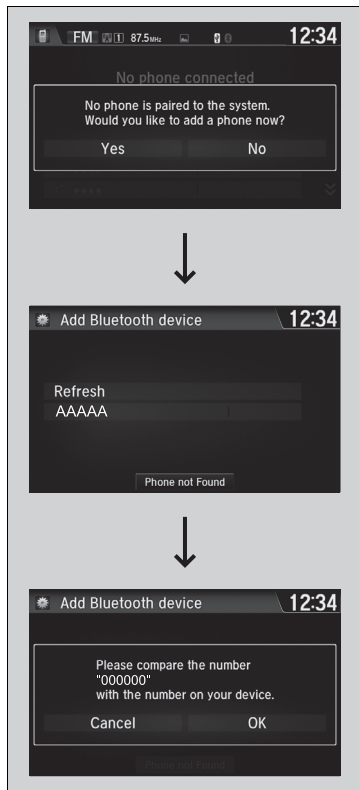

■ To pair a mobile phone (when there is no phone paired to the system)

1. Select **Phone**.
2. Select **Yes**.
3. Make sure your phone is search or discoverable mode, then select **Continue**.
 - ▶ HFT automatically searches for a *Bluetooth* device.
4. Select your phone when it appears on the list.
 - ▶ If your phone does not appear, you can select **Refresh** to search again.
 - ▶ If your phone still does not appear, select **Phone not found** and search for *Bluetooth* devices using your phone. From your phone, search for **Honda HFT**.
5. The system gives you a pairing code on the audio/information screen.
 - ▶ Confirm if the pairing code on the screen and your phone match. This may vary by phone.

☞ Phone Setup

Your *Bluetooth*-compatible phone must be paired to the system before you can make and receive hands-free calls.

Phone Pairing Tips:

- You cannot pair your phone while the vehicle is moving.
- Up to six phones can be paired.
- Your phone's battery may drain faster when it is paired to the system.
- If your phone is not ready for pairing or not found by the system, the system will return to the previous screen.

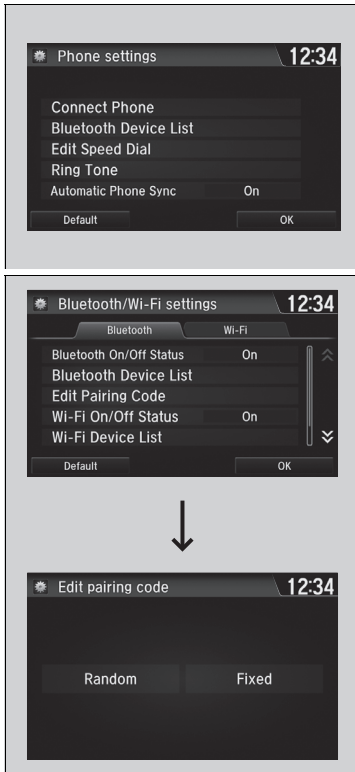

■ To change the currently paired phone

1. Go to the **Phone settings** screen.
 - ▶ **Phone settings screen** P. 359
2. Select **Connect Phone**.
3. Select a phone to connect.
 - ▶ HFT disconnects the current phone and starts searching for another paired phone.

■ To change the pairing code setting

1. Select **HOME**.
2. Select **Settings**.
3. Select **Bluetooth/Wi-Fi**.
4. Select **Bluetooth** tab.
5. Select **Edit Pairing Code**.
6. Select **Fixed** or **Random**.

▶▶ To change the currently paired phone

If no other phones are found or paired when trying to switch to another phone, HFT will inform you that the original phone is connected again.

To pair other phones, select **Add Bluetooth Device** from the **Connect Phone** screen.

▶▶ To change the pairing code setting

The default pairing code is **0000** until you change the setting.

To create your own, select **Fixed**, and delete the current code, then enter a new one.

For a randomly generated pairing code each time you pair a phone, select **Random**.

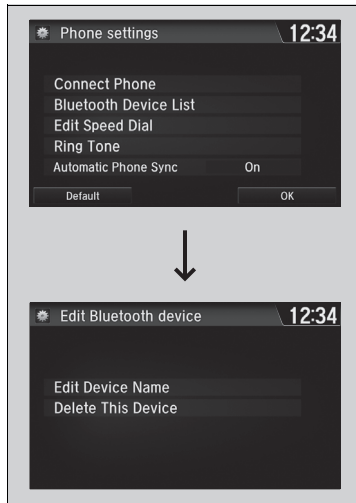

■ **To edit an already-paired phone name**

1. Go to the **Phone settings** screen.
 - ▶ **Phone settings screen** P. 359
2. Select **Bluetooth Device List**.
3. Select a paired phone you want to edit.

4. Select **Edit Device Name**.
5. Edit the name and select **OK**.
6. A notification appears if the change is successful.

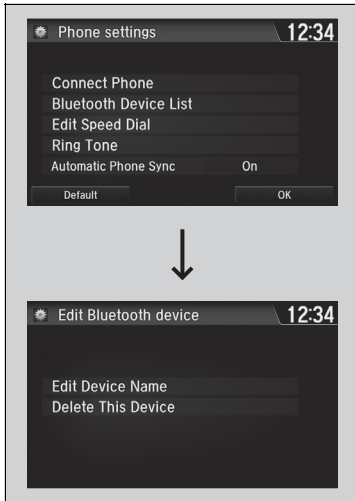

■ To delete a paired phone

1. Go to the **Phone settings** screen.
 - ▶ **Phone settings screen** P. 359
2. Select **Bluetooth Device List**.
3. Select a phone you want to delete.
4. Select **Delete This Device**.
5. You will receive a confirmation message on the screen. Select **Yes**.
6. A notification appears if the deletion is successful.

■ Ring Tone

You can change the ring tone setting.

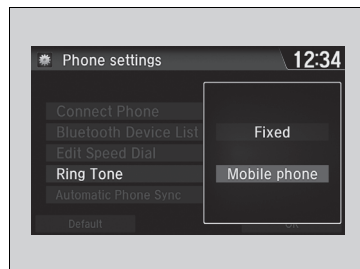

1. Go to the **Phone settings** screen.
 - ▶ **Phone settings screen** P. 359
2. Select **Ring Tone**.
3. Select **Fixed** or **Mobile Phone**.

▶▶ Ring Tone

Fixed: The fixed ring tone sounds from the speaker.

Mobile Phone: The ring tone stored in the connected mobile phone sounds from the speaker.

Automatic Import of Cellular Phonebook and Call History

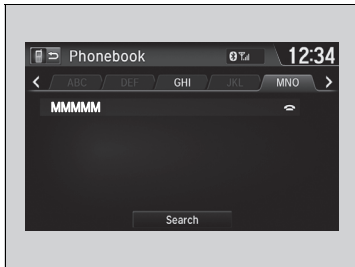

■ When Automatic Phone Sync is set to On:

When your phone is paired, the contents of its phonebook and call history are automatically imported to the system.

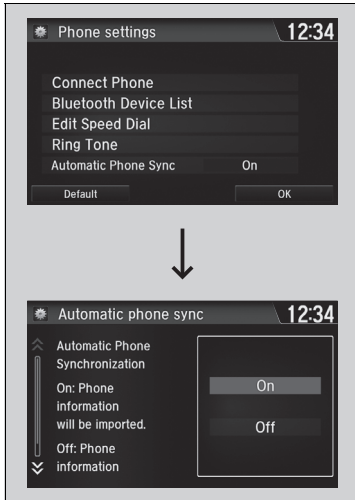

■ Changing the Automatic Phone Sync setting

1. Go to the **Phone settings** screen.
 - ▶ **Phone settings screen** P. 359
2. Select **Automatic Phone Sync**.
3. Select **On** or **Off**.

⊠ Automatic Import of Cellular Phonebook and Call History

When you select a person from the list in the cellular phonebook, you can see up to three category icons. The icons indicate what types of numbers are stored for that name.

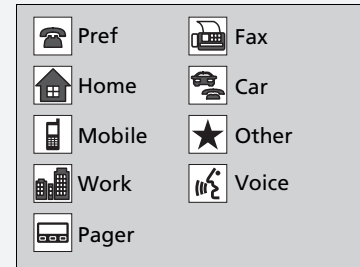

On some phones, it may not be possible to import the category icons to the system.

The phonebook is updated after every connection. Call history is updated after every connection or call.

Speed Dial

Up to 20 speed dial numbers can be stored per phone.

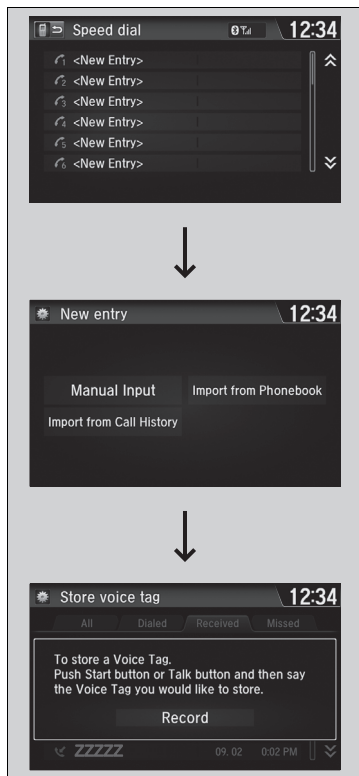

To store a speed dial number:

1. Go to the **Phone menu** screen.
 - ▶ **Phone menu screen** P. 361
2. Select **Speed Dial**.
3. Select **New Entry**.
4. Select a place to choose a number.
 - From **Import from Call History**:
 - ▶ Select a number from the call history.
 - From **Manual Input**:
 - ▶ Input the number manually.
 - From **Import from Phonebook**:
 - ▶ Select a number from the connected mobile phone's imported phonebook.
5. When the speed dial is successfully stored, you are asked to create a voice tag for the number. Select **Yes** or **No**.
6. Select **Record** to store a voice tag for the speed dial entry.
 - ▶ Using the  button, follow the prompts to store a voice tag for the speed dial entry.

Speed Dial

When a voice tag is stored, press the  button to call the number using the voice tag. Say the voice tag name.

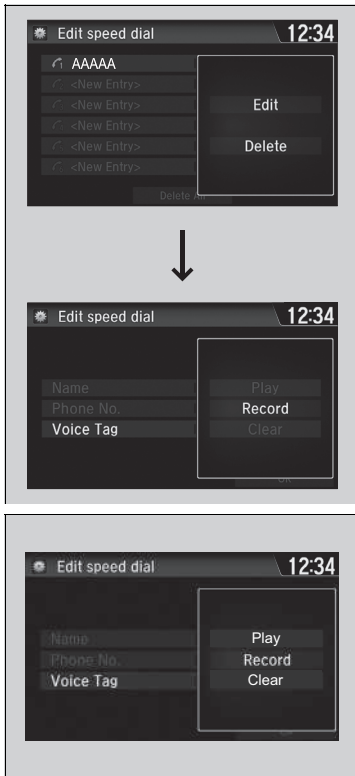

■ To add a voice tag to a stored speed dial number

1. Go to the **Phone settings** screen.
▶ **Phone settings screen** P. 359
2. Select **Edit Speed Dial**.
3. Select an existing speed dial entry.
▶ From the pop-up menu, select **Edit**.
4. Select **Voice Tag**.
▶ From the pop-up menu, select **Record**.
5. Select **Record** to store the voice tag.
6. Using the  button, follow the prompts to complete the voice tag.

■ To delete a voice tag

1. Go to the **Phone settings** screen.
▶ **Phone settings screen** P. 359
2. Select **Edit Speed Dial**.
3. Select an existing speed dial entry.
▶ From the pop-up menu, select **Edit**.
4. Select **Voice Tag**.
▶ From the pop-up menu, select **Clear**.
5. A confirmation message appears on the screen. Select **Yes**.

☒ Speed Dial

Avoid using duplicate voice tags.
Avoid using "home" as a voice tag.
It is easier for the system to recognize a longer name.
For example, use "John Smith" instead of "John."

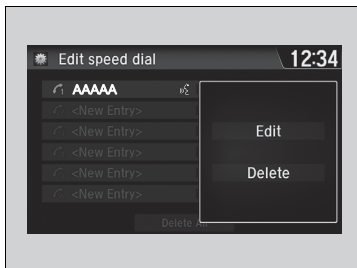

■ To edit a speed dial

1. Go to the **Phone settings** screen.
 - ▶ **Phone settings screen** P. 359
2. Select **Edit Speed Dial**.
3. Select an existing speed dial entry.
 - ▶ From the pop-up menu, select **Edit**.
4. Select a setting you want.

■ To delete a speed dial

1. Go to the **Phone settings** screen.
 - ▶ **Phone settings screen** P. 359
2. Select **Edit Speed Dial**.
3. Select an existing speed dial entry.
 - ▶ From the pop-up menu, select **Delete**.
4. A confirmation message appears on the screen. Select **Yes**.

■ Making a Call

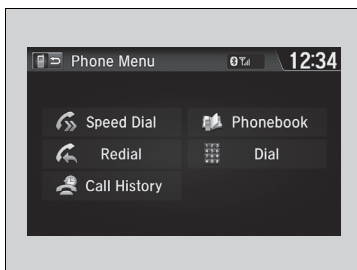

You can make calls by inputting any phone number, or by using the imported phonebook, call history, speed dial entries, or redial.

▶ Making a Call

Any voice-tagged speed dial entry can be dialed by voice from most screens.

Press the  button and say the voice tag name.

The maximum range between your phone and vehicles is 10 metres (30 feet).

Once a call is connected, you can hear the voice of the person you are calling through the audio speakers.

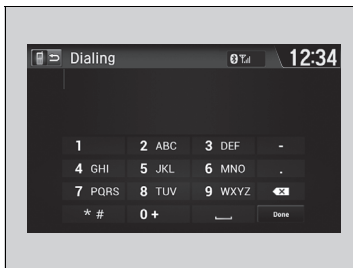
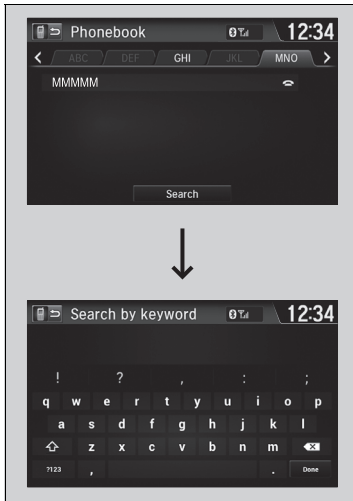

■ To make a call using the imported phonebook

1. Go to the **Phone menu** screen.
 - ▶ **Phone menu screen** P. 361
2. Select **PhoneBook**.
3. Select a name.
 - ▶ You can also search by letter. Select **Search**.
 - ▶ Use the keyboard on the touch screen for entering letters.
4. Select a number.
 - ▶ Dialing starts automatically.

■ To make a call using a phone number

1. Go to the **Phone menu** screen.
 - ▶ **Phone menu screen** P. 361
2. Select **Dial**.
3. Select a number.
 - ▶ Use the keyboard on the touch screen for entering numbers.
4. Select **Done**.
 - ▶ Dialing starts automatically.

☒ To make a call using the imported phonebook

This function is disabled while the vehicle is moving. However, you can call a stored voice-tagged speed dial number using voice commands.

- ▶ **Limitations for Manual Operation** P. 358
- ▶ **Speed Dial** P. 368

☒ To make a call using a phone number

This function is disabled while the vehicle is moving. However, you can call a stored voice-tagged speed dial number using voice commands.

- ▶ **Limitations for Manual Operation** P. 358
- ▶ **Speed Dial** P. 368

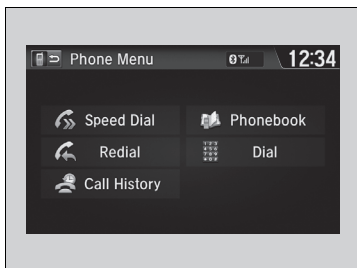

■ **To make a call using redial**

1. Go to the **Phone menu** screen.
 - ▶ **Phone menu screen** P. 361
2. Select **Redial**.
 - ▶ Dialing starts automatically.

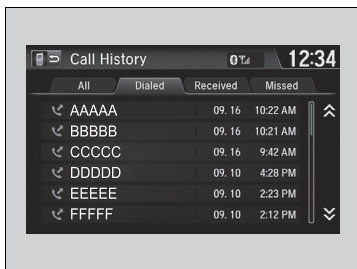

■ **To make a call using the call history**

Call history is stored by **All, Dialed, Received, and Missed.**

1. Go to the **Phone menu** screen.
 - ▶ **Phone menu screen** P. 361
2. Select **Call History**.
3. Select **All, Dialed, Received, or Missed.**
4. Select a number.
 - ▶ Dialing starts automatically.

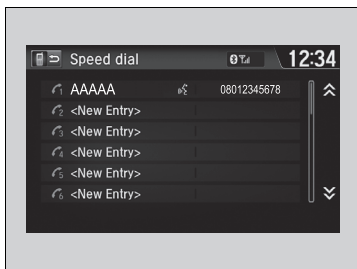

■ **To make a call using a speed dial entry**

1. Go to the **Phone menu** screen.
 - ▶ **Phone menu screen** P. 361
2. Select **Speed Dial**.
3. Select a number.
 - ▶ Dialing starts automatically.

▶▶ To make a call using redial

Press and hold the button to redial the last number dialed in your phone's history.

▶▶ To make a call using the call history

The call history displays the last 20 dialed, received, or missed calls. (Appears only when a phone is connected to the system.)

▶▶ To make a call using a speed dial entry

When a voice tag is stored, press the button to call the number using the voice tag.

▶ **Speed Dial** P. 368



Any voice-tagged speed dial entry can be dialed by voice from any screen.

Press the button and follow the prompts.

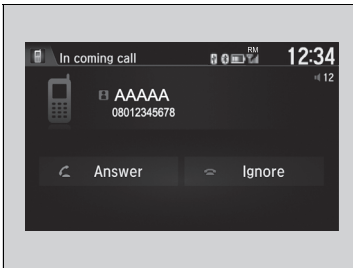
Receiving a Call



When there is an incoming call, an audible notification sounds and the **Incoming call** screen appears.

Press the  button to answer the call.
Press the  button to decline or end the call.

Options During a Call

The following options are available during a call.

Mute: Mute your voice.

▶ The mute icon appears when **Mute** is selected. Select **Mute** again to turn it off.

Transfer: Transfer a call from the system to your phone.

Touch Tones: Send numbers during a call. This is useful when you call a menu-driven phone system.

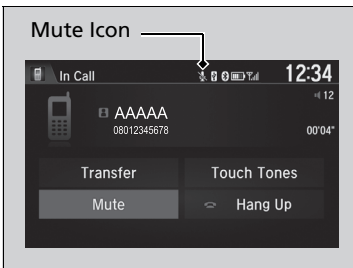

The available options are shown on the lower half of the screen.

Select the option.

▶ The mute icon appears when **Mute** is selected. Select **Mute** again to turn it off.

Receiving a Call



Call Waiting

Press the  button to put the current call on hold to answer the incoming call.

Press the  button again to return to the current call.

Select **Ignore** to ignore the incoming call if you do not want to answer it.

Press the  button if you want to hang up the current call.

You can select the icons on the touch screen instead of the  and  buttons.

Options During a Call

Touch Tones: Available on some phones.

You can select the icons on the touch screen.

Driving



This chapter discusses driving, refueling, and information on items such as accessories.

Before Driving	376
Towing a Trailer	380
When Driving	
Models without keyless access system	
Starting the Engine	386
Models with keyless access system	
Starting the Engine	389
Precautions While Driving	393
Continuously Variable Transmission*	395
Continuously variable transmission models	
Shifting	396
Manual transmission models	
Shifting	401
Continuously variable transmission models	
Auto Idle Stop	404

Manual transmission models	
Auto Idle Stop	409
Cruise Control	414
Adjustable Speed Limiter	417
Intelligent Speed Limiter	421
Forward Collision Warning*	428
Lane Departure Warning*	432
Traffic Sign Recognition System*	436
Vehicle Stability Assist (VSA) System	440
Agile Handling Assist System	442
Deflation Warning System	443
Adjusting Headlight Distribution	445
Braking	
Brake System	446
Anti-lock Brake System (ABS)	448

Brake Assist System	449
City-Brake Active system	450
Emergency Stop Signal	455
Parking Your Vehicle	
When Stopped	456
Parking Sensor System*	457
Multi-View Rear Camera*	
About Your Multi-View Rear Camera....	462
Refueling	
Fuel Information	464
How to Refuel	465
Fuel Economy	
Improving Fuel Economy	466
Accessories and Modifications	
Accessories	467
Modifications	467

* Not available on all models

Driving Preparation

Check the following items before you start driving.

Exterior Checks

- Make sure there are no obstructions on the windows, door mirrors, exterior lights, or other parts of the vehicle.
 - ▶ Remove any frost, snow, or ice.
 - ▶ Remove any snow on the roof, as this can slip down and obstruct your field of vision while driving. If frozen solid, remove ice once it has softened.
 - ▶ When removing ice from around the wheels, be sure not to damage the wheel or wheel components.
- Make sure the bonnet is securely closed.
 - ▶ If the bonnet opens while driving, your front view will be blocked.
- Make sure the tyres are in good condition.
 - ▶ Check air pressures, check for damage and excessive wear.
 - ✎ **Checking and Maintaining Tyres** P. 508
- Make sure there are no people or objects behind or around the vehicle.
 - ▶ There are blind spots from the inside.

Exterior Checks

NOTICE

When doors are frozen shut, use warm water around the door edges to melt any ice. Do not try to force them open, as this can damage the rubber trim around the doors. When done, wipe dry to avoid further freezing.

Do not pour warm water into the key cylinder. You will be unable to insert the key if the water freezes in the hole.

Heat from the engine and exhaust can ignite flammable materials left under the bonnet, causing a fire. If you've parked your vehicle for an extended period, inspect and remove any debris that may have collected, such as dried grass and leaves that have fallen or have been carried in for use as a nest by a small animal. Also check under the bonnet for leftover flammable materials after you or someone else has performed maintenance on your vehicle.

Interior Checks

- Store or secure all items on board properly.
 - ▶ Carrying too much luggage, or improperly storing it, can affect your vehicle's handling, stability, stopping distance, and tyres, and make it unsafe.
 - **Load Limit** P. 379
- Do not pile items higher than the seat height.
 - ▶ They can block your view and may be thrown forward in the event of sudden braking.
- Do not place anything in the front seat footwells. Make sure to secure the floor mat*.
 - ▶ An object or unsecured floor mat can interfere with your brake and accelerator pedal operation while driving.
- If you have any animals on board, do not let them move around in the vehicle.
 - ▶ They may interfere with driving and a crash could occur.
- Securely close all doors and the tailgate.
- Adjust your seating position properly.
 - ▶ Adjust the head restraint, too.
 - **Adjusting the Seats** P. 183
 - **Adjusting the Head Restraints** P. 185
- Adjust the mirrors and steering wheel properly for your driving.
 - ▶ Adjust them while sitting in the proper driving position.
 - **Adjusting the Mirrors** P. 181
 - **Adjusting the Steering Wheel** P. 180

Interior Checks

The headlight aim is set by the factory, and does not need to be adjusted. However, if you regularly carry heavy items in the luggage area or tow a trailer, have the aiming readjusted at a dealer or by a qualified technician.

You can adjust the low beam headlight angle by your self.

➤ **Headlight Adjuster** P. 171

- Be sure items placed on the floor behind the front seats cannot roll under the seats.
 - ▶ They can interfere with the driver's ability to operate the pedals, or the operation of the seats.
- Everyone in the vehicle must fasten their seat belt.
 - 📖 **Fastening a Seat Belt** P. 42
- Make sure that the indicators in the instrument panel come on when you start the vehicle, and go off soon after.
 - ▶ Always have a dealer check the vehicle if a problem is indicated.
 - 📖 **Indicators** P. 84

Load Limit

When you load luggage, the total weight of the vehicle, all passengers, and luggage must not exceed the maximum permissible weight.

📄 **Specifications** P. 582

The load for the front and rear axles also must not exceed the maximum permissible axle weight.

📄 **Specifications** P. 582

⚠ Load Limit

⚠ WARNING

Overloading or improper loading can affect handling and stability and cause a crash in which you can be hurt or killed.

Follow all load limits and other loading guidelines in this manual.

Towing Preparation

Towing Load Limits

Your vehicle can tow a trailer if you carefully observe the load limits, use the proper equipment, and follow the towing guidelines. Check the load limits before driving.

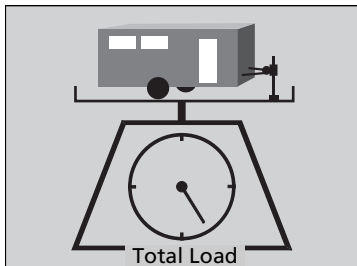

■ Total trailer weight

Do not exceed the maximum towing weight of the trailer and towbar (with/without brakes), luggage and everything in or on it.

Towing loads in excess of the maximum towing weight can seriously affect vehicle handling and performance and can damage the engine and drivetrain.

🔗 Towing Load Limits

⚠️ WARNING

Exceeding any load limit or improperly loading your vehicle and trailer can cause a crash in which you can be seriously hurt or killed.

Check the loading of your vehicle and trailer carefully before starting to drive.

Check if all loads are within limits at a public scale. If a public scale is not available, add the estimated weight of your luggage load to the weight of your trailer (as quoted by the manufacturer), and the trailer nose load.

Break-in Period

Avoid towing a trailer during your vehicle's first 1,000 km (625 miles).

If you tow a trailer in mountainous conditions, remember to reduce 10% of the combined vehicle and trailer weights from the maximum towing weight for every 1,000 metres of elevation.

Never exceed the maximum towing weight and any specified load limit.

🔗 **Specifications** P. 585

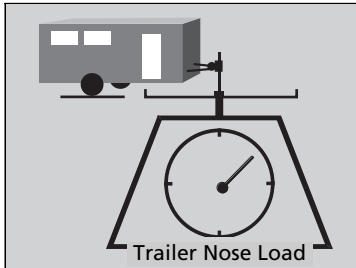

■ Trailer Nose load

The trailer nose load should never exceed 95 kg (209 lbs). This is the amount of weight the trailer puts on the towbar when it is fully-loaded. As a rule of thumb for trailer weights of less than 950 kg (2,094 lbs), the trailer nose load should be 10 percent of the total trailer package.

- Excessive trailer nose load reduces front tyre traction and steering control. Too little trailer nose load can make the trailer unstable and cause it to sway.
- To achieve a proper trailer nose load, start by loading 60% of the load toward the front of the trailer and 40% toward the rear. Readjust the load as needed.

■ Towing Equipment and Accessories

Towing equipment varies by the size of your trailer, how much load you are towing, and where you are towing.

■ Towbars

The towbar must be of an approved type and properly bolted to the underbody.

■ Safety chains

Always use safety chains when you tow a trailer. Leave enough slack to allow the trailer to turn corners easily, but do not allow the chains to drag on the ground.

■ Trailer brakes

If you are thinking of getting a trailer that has brakes, be sure they are electronically actuated. Do not attempt to tap into your vehicle's hydraulic system. No matter how successful it may seem, any attempt to attach trailer brakes to your vehicle's hydraulic system will lower braking effectiveness and create a potential hazard.

■ Additional towing equipment

There may be laws requiring special outside mirrors when towing a trailer. Even if mirrors are not required in your locale, you should install special mirrors if visibility is restricted in any way.

■ Trailer light

Trailer lights and equipment must comply with the regulations of the country where you are driving. Check with your local trailer sales or rental agency for the requirements in the area where you plan to tow.

► Towing Equipment and Accessories

Make sure that all equipment is properly installed and maintained, and that it meets the regulations of the country where you are driving.

Consult your trailer sales or rental agency if any other items are recommended or required for your towing situation.

The lighting and wiring of trailers can vary by type and brand. If a connector is required, it should only be installed by a qualified technician.

Driving Safely with a Trailer

■ Things You Need To Know Before Towing a Trailer

- Have the trailer properly serviced and keep it in good condition.
- Make sure that all the weights and load in the vehicle and trailer are within limits.
 - ▣ **Towing Load Limits** P. 380
- Securely attach the tow bar, safety chains, and other necessary parts to the trailer.
- Securely store all the items in and on the trailer so that they do not shift while driving.
- Check if the lights and brakes on the trailer are working properly.
- Check the pressures of the trailer tyres, including the spare.
- Check regulations concerning the maximum speed or driving restrictions for vehicles towing trailers. If you are driving across several countries, check each country's requirements before leaving home, because regulations may vary.
- Turn off the Auto Idle Stop system using the Auto Idle Stop OFF button. The trailer weight can affect your vehicle's brake effectiveness if Auto Idle Stop is activated on a hill while towing a trailer.

▣ Driving Safely with a Trailer

Operating speed when towing a trailer is restricted up to 100 km/h (62 mph).

Parking

In addition to the normal precautions, place wheel chocks at each of the trailer's tyres.

We recommend you drive uphill or less than 12% slope. Follow the trailer association's recommendations for suitable roads.

Winds caused by passing large vehicles can sway your trailer, keep a constant speed and steer straight ahead.

Always drive slowly and have someone guide you when reversing.

■ Towing Speeds and Gears

- Drive slower than normal.
- Obey posted speed limits for vehicles with trailers.

Continuously variable transmission models

- Use the **D** position when towing a trailer on level roads.

Manual transmission models

- Either shift up or shift down indicator will come on at the best time to shift to a higher or lower gear for the better fuel economy.

▶▶ Towing Speeds and Gears

The shift down indicator will not prompt to downshift to 1st gear. It is up to you to downshift to 1st gear to increase engine braking. Avoid sudden engine braking.

Road and traffic conditions may require you to shift at times other than those indicated.

Turning and Braking

- Turn more slowly and with a wider turning arc than normal.
- Allow more time and distance for braking.
- Do not brake or turn suddenly.

Driving in Hilly Terrain

- Closely watch your high temperature indicator. If the indicator remains on, turn off the heating and cooling system*/climate control system* and reduce speed. Pull to the side of the road safely to cool down the engine if necessary.

Continuously variable transmission models

- Shift to the **[S]** position and use the paddle shifter to shift down when driving down hills.

This helps to increase engine braking efficiently and prevent the brake system from overheating.

Models without keyless access system

Starting the Engine

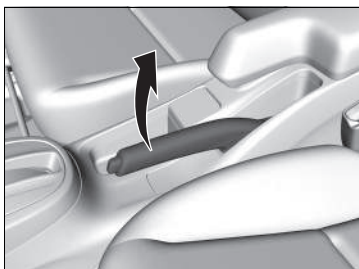

1. Make sure the parking brake is applied.

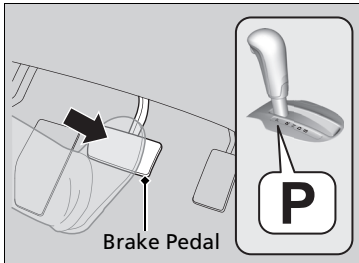

Continuously variable transmission models

2. Check that the shift lever is in **P**, then depress the brake pedal.
 - ▶ Although it is possible to start the vehicle in **N**, it is safer to start it in **P**.

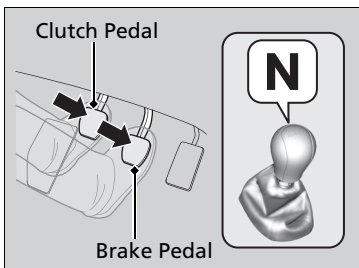

Manual transmission models

2. Check that the shift lever is in **N**. Then depress the brake pedal with your right foot, and the clutch pedal with your left foot.
 - ▶ The clutch pedal must be fully depressed to start the engine.

Starting the Engine

Keep your foot firmly on the brake pedal when starting the engine.

The engine is harder to start in cold weather and in thinner air found at altitudes above 2,400 metres (8,000 feet).

When starting the engine in cold weather, turn off all electrical accessories such as the lights, heating and cooling system*/climate control system*, and rear demister in order to reduce battery drain.

If the exhaust system sounds abnormal or you can smell exhaust gas inside the vehicle, have your vehicle checked by a dealer. There may be a problem with the engine or exhaust system.

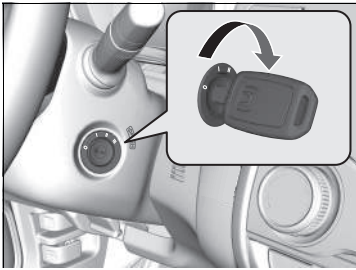

All models

3. Turn the ignition switch to START  without depressing the accelerator pedal.

Starting to Drive

Continuously variable transmission models

1. Keeping your right foot on the brake pedal, release the parking brake. Check that the parking brake indicator has gone off.
 **Parking Brake** P. 446
2. Put the shift lever in **D**. Select **R** when reversing.
3. Gradually release the brake pedal and gently depress the accelerator pedal to pull away.

Starting the Engine

Do not hold the key in START  for more than 15 seconds.

- If the engine does not start right away, wait for at least 10 seconds before trying again.
- If the engine starts, but then immediately stops, wait at least 10 seconds before repeating step 3 while gently depressing the accelerator pedal. Release the accelerator pedal once the engine starts.

The immobilizer system protects your vehicle from theft. If an improperly coded device is used, the engine's fuel system is disabled.

 **Immobilizer System** P. 156

Starting to Drive

Manual transmission models

If the engine stalls, fully depress the clutch pedal within three seconds.
 The engine may automatically restart under certain conditions.
 Otherwise, follow the standard procedure.

■ Hill start assist system

Hill start assist keeps the brake engaged briefly to help to prevent the vehicle from rolling on inclines as you move your foot from the brake pedal to the accelerator.

Manual transmission models

Depress the clutch pedal, and shift to one of the forward gears when facing uphill, or **R** when facing downhill, then release the brake pedal.

Continuously variable transmission models

Move the shift lever to **D** or **S** when facing uphill, or **R** when facing downhill, then release the brake pedal.

ⓘ Hill start assist system

Hill start assist may not prevent the vehicle from rolling downhill on a very steep or slippery slope, and does not operate on small inclines.

Hill start assist is not a replacement for the parking brake.

Models with keyless access system

Starting the Engine

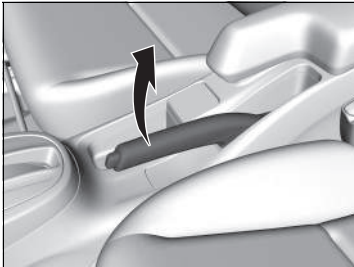

1. Make sure the parking brake is applied.

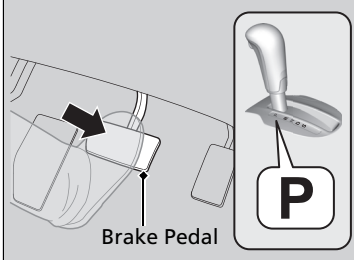

Continuously variable transmission models

2. Check that the shift lever is in **P**, then depress the brake pedal.

- ▶ Although it is possible to start the vehicle in **N**, it is safer to start it in **P**.

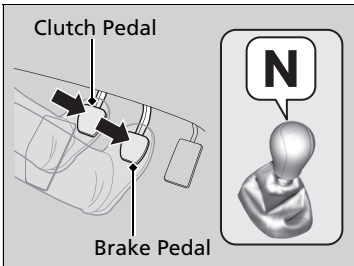

Manual transmission models

2. Check that the shift lever is in **N**. Then depress the brake pedal with your right foot, and the clutch pedal with your left foot.

- ▶ The clutch pedal must be fully depressed to start the engine.

▶ Starting the Engine

Keep your foot firmly on the brake pedal when starting the engine.

The engine is harder to start in cold weather and in thinner air found at altitudes above 2,400 metres (8,000 feet).

When starting the engine in cold weather, turn off all electrical accessories such as the lights, climate control system, and rear demister in order to reduce battery drain.

If the exhaust system sounds abnormal or you can smell exhaust gas inside the vehicle, have your vehicle checked by a dealer. There may be a problem with the engine or exhaust system.

The immobilizer system protects your vehicle from theft. If an improperly coded device is used, the engine's fuel system is disabled.

▶ **Immobilizer System** P. 156

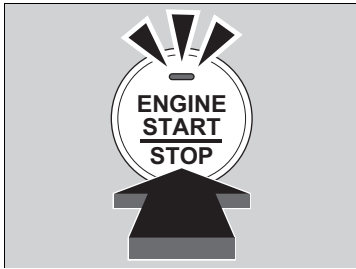

All models

3. Press the **ENGINE START/STOP** button without depressing the accelerator pedal.

▶▶ Starting the Engine

Bring the keyless remote close to the **ENGINE START/STOP** button if the battery in the keyless remote is weak.

- ▶ **If the Keyless Remote Battery is Weak**
P. 552

The engine may not start if the keyless remote is subjected to strong radio waves.

Do not hold the **ENGINE START/STOP** button to start the engine.
If the engine does not start, wait at least 10 seconds before trying again.

Stopping the Engine

You can turn the engine off when the vehicle is completely stopped.

Continuously variable transmission models

1. Shift to **[P]**.
2. Press the **ENGINE START/STOP** button.

Manual transmission models

- If the shift lever is in **[N]**, press the **ENGINE START/STOP** button.
- If the shift lever is in any gear other than **[N]**, depress the clutch pedal, then press the **ENGINE START/STOP** button.

Starting to Drive

Continuously variable transmission models

1. Keeping your right foot on the brake pedal, release the parking brake. Check that the parking brake indicator has gone off.
 - **Parking Brake** P. 446
2. Put the shift lever in **[D]**. Select **[R]** when reversing.
3. Gradually release the brake pedal and gently depress the accelerator pedal to pull away.

Starting to Drive

Manual transmission models

If the engine stalls, fully depress the clutch pedal within three seconds. The engine may automatically restart under certain conditions. Otherwise, follow the standard procedure.

■ Hill start assist system

Hill start assist keeps the brake engaged briefly to help to prevent the vehicle from rolling on inclines as you move your foot from the brake pedal to the accelerator.

Continuously variable transmission models

Move the shift lever to **D** or **S** when facing uphill, or **R** when facing downhill, then release the brake pedal.

Manual transmission models

Depress the clutch pedal, and shift to one of the forward gears when facing uphill, or **R** when facing downhill, then release the brake pedal.

⌘ Hill start assist system

Hill start assist may not prevent the vehicle from rolling downhill on a very steep or slippery slope, and does not operate on small inclines.

Hill start assist is not a replacement for the parking brake.

Precautions While Driving

In Rain

Avoid driving in deep water and on flooded roads. This can damage the engine or driveline, or cause electrical component failure.

Precautions While Driving

CAUTION: Do not drive on the road where water is deep. Driving through deep water will cause damage to the engine and electrical equipment and the vehicle will break down.

NOTICE

Do not operate the shift lever while pressing the accelerator pedal. You could damage the transmission.

NOTICE

If you repeatedly turn the steering wheel at an extremely low speed, or hold the steering wheel on the full left or right position for a while, the electric power steering (EPS) system heats up. The system goes into a protective mode, and limits its performance. The steering wheel becomes harder and harder to operate. Once the system cools down, the EPS system is restored. Repeated operation under these conditions can eventually damage the system.

If the ignition switch is turned to ACCESSORY **I** or LOCK **0**^{*1} while driving, the engine will shut down and all steering and brake power assist functions will stop, making it difficult to control the vehicle.

Do not put the shift lever in **N**, as you will lose engine braking (and acceleration) performance.

*1: Models with the keyless access system have an **ENGINE START/STOP** button instead of an ignition switch.

■ Other Precautions

If there is a strong impact with something under the vehicle, stop in a safe location. Check the underside of the vehicle for damage or any fluid leaks.

▣ Precautions While Driving

During the first 1,000 km (625 miles) of operation, avoid sudden acceleration or full throttle operation so as to not damage the engine or powertrain.

Avoid hard braking for the first 300 km (200 miles). You should also follow this when the brake pads are replaced.

NOTICE

The following can damage the under spoiler:

- Parking the vehicle by a parking block
- Parallel parking along the road shoulder
- Driving towards the bottom of a hill
- Driving up or down to a different surface level (such as a road shoulder)
- Driving on a rutted or bumpy road
- Driving on a road with potholes.

Continuously Variable Transmission *

■ Creeping

The engine runs at a higher idle speed and creeping increases.
Keep the brake pedal firmly depressed when stopped.

■ Kickdown

Quickly depressing the accelerator pedal while driving uphill may cause the transmission to drop to a lower gear, unexpectedly increasing vehicle speed. Depress the accelerator pedal carefully, especially on slippery roads and curves.

Continuously variable transmission models

Shifting

Change the shift position in accordance with your driving needs.

■ Shift lever positions



P **Park**
Used when parking or starting the engine

R **Reverse**
Used when reversing

N **Neutral**
Used when idling

D **Drive**
Used:
• For normal driving
• When temporarily driving in the 7-speed manual shift mode

S **Drive (S)**
Used:
• For better acceleration
• To increase engine braking
• When going up or down hills
• When driving in the 7-speed manual shift mode
• When towing a trailer in hilly terrain

» Shifting

Models without keyless access system

You cannot turn the ignition switch to LOCK [0] and remove the key unless the shift lever is in [P].

Models with keyless access system

You cannot change the power mode from ON to VEHICLE OFF (LOCK) unless the shift lever is in [P].

The vehicle may move forward very slightly even in [N] while the engine is cold. Depress the brake pedal firmly and, when necessary, apply the parking brake.

When shifting positions in extremely low temperatures (-30°C), there may be a short delay before the shift position is displayed. Always confirm you are in the correct shift position before driving.

Shift Lever Operation

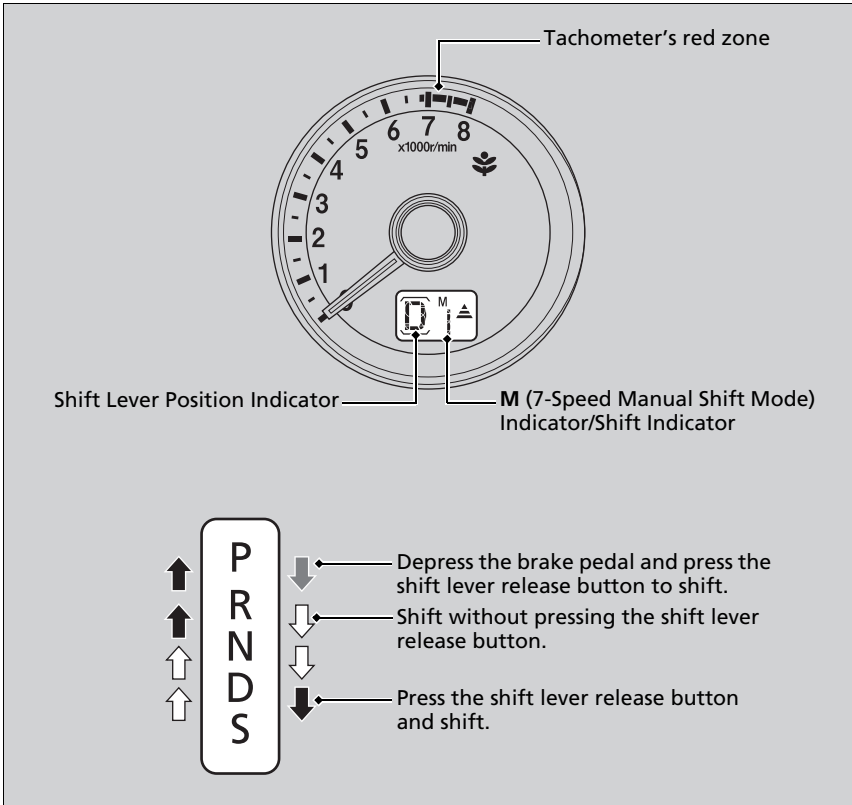

Shift Lever Operation

NOTICE

When you change the shift lever from **D** to **R** and vice versa, come to a complete stop and keep the brake pedal depressed. Operating the shift lever before the vehicle has come to a complete standstill can damage the transmission.

Use the shift lever position indicator to check the lever position before pulling away.

If the transmission indicator blinks when driving, in any shift position, there is a problem with the transmission. Avoid sudden acceleration and have the transmission checked by a dealer as soon as possible.

The fuel supply may be cut off if you drive at engine speeds in or over the tachometer's red zone (engine speed limit). If this happens, you may experience a slight jolt.

It may not be possible to operate the shift lever if the brake pedal is applied while the shift lever release button is pressed. Depress the brake pedal first.

■ 7-Speed Manual Shift Mode

Use the paddle shifters to change between 1st and 7th speeds without removing your hands from the steering wheel. The transmission switches to the 7-speed manual shift mode when you pull a paddle shifter while driving. This mode is useful when engine braking is needed.

■ When the shift lever is in **D**:

The shift mode goes into the 7-speed manual shift mode temporarily, and the number is displayed in the shift indicator.

The 7-speed manual shift mode is cancelled automatically if you drive at constant speed or accelerate, and the number in the shift indicator goes off.

You can cancel this mode by pulling the **+** paddle shifter for a few seconds.

The 7-speed manual shift mode is especially useful when reducing the vehicle speed temporarily before making a turn.

■ When the shift lever is in **S**:

The shift mode goes into the 7-speed manual shift mode. The **M** indicator and the speed number are displayed in the shift indicator. As the vehicle speed slows down, the transmission automatically shifts down accordingly. When the vehicle comes to a stop, it automatically shifts down into 1st.

If the vehicle speed increases and the engine speed reaches near the tachometer's red zone, the transmission automatically shifts up.

You can only pull away in 1st gear.

When cancelling the 7-speed manual shift mode, move the shift lever from **S** to **D**. When the 7-speed manual shift mode is cancelled, the **M** indicator and shift indicator go off.

You can cancel this mode by pulling the **+** paddle shifter for a few seconds.

▶▶ 7-Speed Manual Shift Mode

In the 7-speed manual shift mode, the transmission shifts up or down by operating either paddle shifter under the following conditions:

Shift Up: The engine speed reaches the lowest threshold of the higher speed position.

Shift Down: The engine speed reaches the highest threshold of the lower speed position.

When the engine speed reaches near the tachometer's red zone, the transmission shifts up automatically.

When the engine speed reaches the lowest threshold of the selected speed position, the transmission shifts down automatically.

Operating the paddle shifters on slippery surfaces may cause the tyres to lock up. In this case, the 7-speed manual shift mode is cancelled and goes back to the normal driving mode.

7-Speed Manual Shift Mode Operation

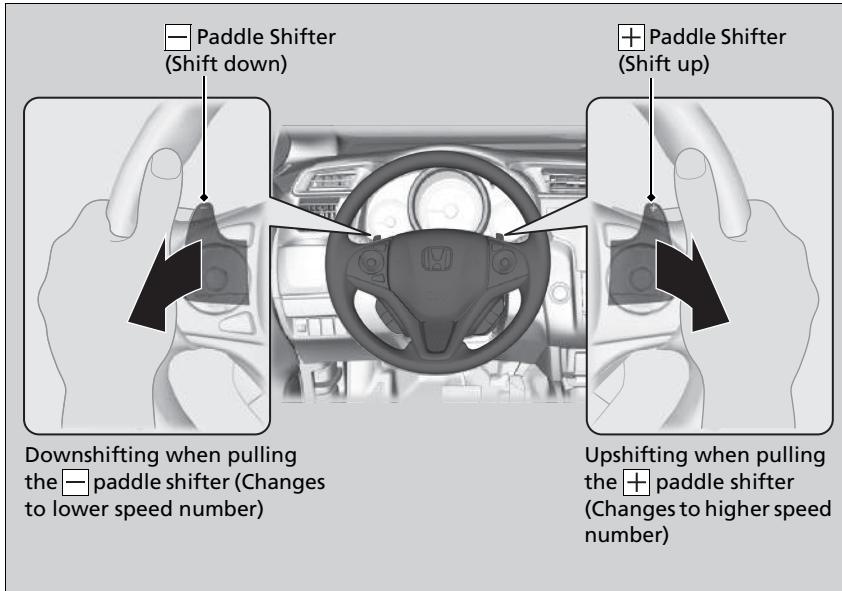

7-Speed Manual Shift Mode Operation

Each paddle shift operation makes a single gear change.

To change continuously, release the paddle shifter before pulling it again for the next speed.

The shift indicator blinks when you cannot shift up or down. It indicates that your vehicle speed is not in its allowable shifting range.

Slightly accelerate to shift up and decelerate to shift down while the indicator is blinking.

The shift indicator may also blink when you cannot shift down while driving in low speed. This prevents the transmission from being damaged.

Shift Up Indicator

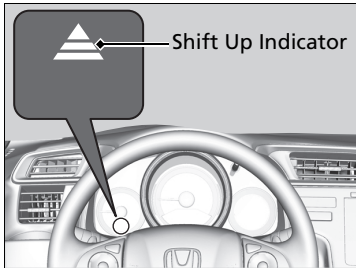

Comes on while the vehicle is in the 7-speed manual shift mode to indicate when a shift change is appropriate to maintain the most fuel efficient driving style.

The shift up indicator: Comes on when shifting up is recommended.

Shift Up Indicator

⚠ WARNING

The shift indicator is only a guide to help you achieve better fuel economy. Never refer to the Shift Indicators when road and traffic conditions are unsuitable or when it may distract you.

Ambient meter colour may change if you do not change transmission when a shift indicator illuminates. This can result in a change in fuel economy.

Road and traffic conditions may require you to shift at times other than those indicated.

Manual transmission models

Shifting**Shift Lever Operation**

Fully depress the clutch pedal to operate the shift lever and change gears, then slowly release the pedal.

Depress the clutch pedal, and pause for a few seconds before shifting into **R**, or shift into one of the forward gears for a moment. This stops the gears so they do not “grind.”

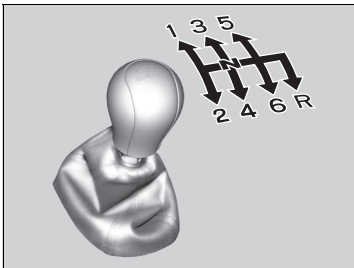

When you are not shifting, do not rest your foot on the clutch pedal. This can cause your clutch to wear out faster.

▶▶ Shifting

NOTICE

Do not shift to **R** before the vehicle comes to a complete stop. Shifting to **R** before stopping can damage the transmission.

NOTICE

Before downshifting, make sure the engine will not go into the tachometer's red zone. Should this occur, it can severely damage your engine.

There is a metallic part on the shift lever. If you leave the vehicle parked outside for a long time on a hot day, be careful before moving the shift lever. Because of heat, the shift lever may be extremely hot. If the outside temperature is low, the shift lever may feel cold.

If you exceed the maximum speed for the gear you are in, the engine speed will enter into the tachometer's red zone. When this happens, you may experience a slight jolt.

Shift Up/Down Indicators

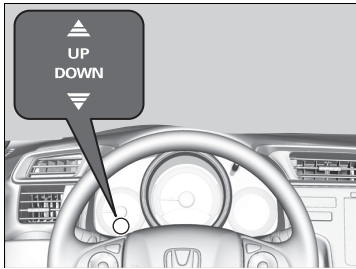

Come on to indicate when a gear change is appropriate to maintain the most fuel efficient driving style.

The shift up indicator: Comes on when shifting up is recommended.

The shift down indicator: Comes on when shifting down is recommended.

Shift Up/Down Indicators

⚠ WARNING

The shift indicator is only a guide to help you achieve better fuel economy. Never refer to the Shift Indicators when road and traffic conditions are unsuitable or when it may distract you.

This indicator will not prompt you to downshift to increase engine braking. It is up to you to downshift to increase engine braking when driving downhill.

Always shift down at the appropriate vehicle speed.

The shift down indicator does not come on when downshifting from **2** to **1**.

Ambient meter colour may change if you do not change gears when a shift indicator illuminates. This can result in a change in fuel economy.

Road and traffic conditions may require you to shift at times other than those indicated.

Reverse Lockout

The manual transmission has a lockout mechanism that stops you from accidentally shifting into **R** from a forward gear while the vehicle is moving above a certain speed.

If you cannot shift to **R** when the vehicle is stopped, do the following:

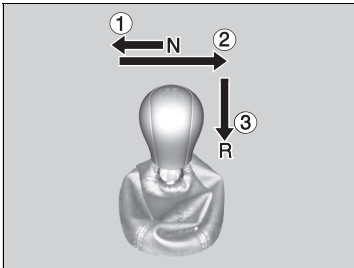

1. Depress the clutch pedal, move the shift lever all the way to the left, and shift to **R**.
2. If you still cannot shift into **R**, apply the parking brake, and turn the ignition switch to ACCESSORY **I** or LOCK **O***1.
3. Depress the clutch pedal and shift into **R**.
4. Keep depressing the clutch pedal and start the engine.

Have your vehicle checked by a dealer if you have to go through this procedure repeatedly.

*1: Models with the keyless access system have an **ENGINE START/STOP** button instead of an ignition switch.

Continuously variable transmission models

Auto Idle Stop

To help to maximise fuel economy, the engine automatically stops when the vehicle comes to a stop, depending on environmental and vehicle operating conditions. The indicator (green) comes on.

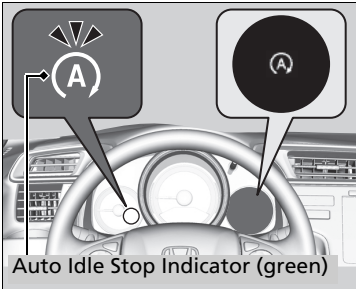

The engine then restarts once the vehicle is about to move again, and the indicator (green) goes off.

If the driver's door is opened while the indicator (green) is on, a buzzer sounds to notify you that the Auto Idle Stop function is in operation.

A message associated with Auto Idle Stop appears on the multi-information display.

- ▶ **Indicators** P. 100, 101
- ▶ **Multi-Information Display Warning and Information Messages** P. 109
- ▶ **Customized Features** P. 129

▶▶ Auto Idle Stop

The battery installed in this vehicle is specifically designed for a model with Auto Idle Stop. Using a battery other than this specified type may shorten the battery life, and prevent Auto Idle Stop from activating. If you need to replace the battery, make sure to select the specified type. Ask a dealer for more details.

▶ **Specifications** P. 582

Auto idle stop may activate less frequently in such condition as a traffic jam.

Auto Idle Stop System ON/OFF

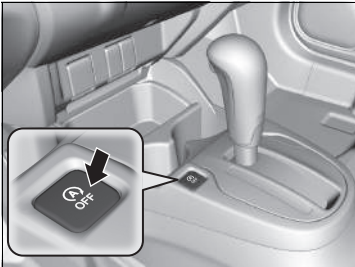

To turn the Auto Idle Stop system off, press this button. The Auto Idle Stop system stops.

- ▶ Auto Idle Stop system will stop and the indicator (amber) will come on.

The Auto Idle Stop system is turned on every time you start the engine, even if you turned it off the last time you drove the vehicle.

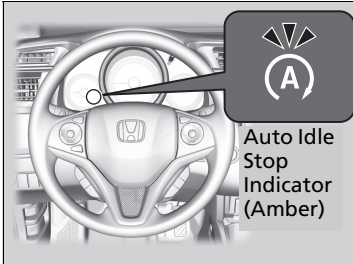



Auto Idle Stop System ON/OFF

Pressing the Auto Idle Stop **OFF** button restarts the engine during the Auto Idle Stop activated.

■ Auto Idle Stop Activates When:

The vehicle stops with the shift lever in  and the brake pedal depressed.

■ Auto Idle Stop does not activate when:

- The driver's seat belt is not fastened.
- The engine coolant temperature is low or high.
- The transmission fluid temperature is low or high.
- The vehicle comes to a stop again before the vehicle speed reaches 5 km/h (3 mph) after the engine starts.
- Stopped on a steep incline.
- The shift lever is in a position other than .
- The engine is started with the bonnet open.
 - ▶ Turn off the engine. Close the bonnet before you restart the engine to activate Auto Idle Stop.
-  is on (indicator (amber) on).
- The battery charge is low.
- The internal temperature of the battery is 5°C or less.

Models with capacitor unit

- The capacitor unit condition is not good.
 - ▶ The capacitor unit is used for a condenser to charge or discharge in a short time.

Models with climate control system

- The climate control system is in use, and the outside temperature is below -20°C or over 40°C.
- The climate control system is in use, and the temperature is set to **Hi** or **Lo**.
-  is on (indicator on).

Models with heating and cooling system

- The fan is turned on and the mode control dial is turned to .

▶ Auto Idle Stop Activates When:

Do not open a bonnet, during idling stop.
If the bonnet is opened, the engine will not restart automatically.

In this case, restart the engine with the **ENGINE START/STOP** button or the ignition switch.

▶ **Starting the Engine** P. 386, 389

Models with keyless access system

Pressing the **ENGINE START/STOP** button changes the power mode to **ACCESSORY** even while Auto Idle Stop is in operation. Once in **ACCESSORY**, the engine no longer restarts automatically. Follow the standard procedure to start the engine.

▶ **Starting the Engine** P. 389

Models without keyless access system

Even if you turn the ignition switch to **START**  during the Auto Idle Stop activated, the engine does not start.

■ Auto idle stop may not activate when:

- The steering wheel is operated.
- Altitude is high.
- The vehicle is stopped by braking suddenly.
- The vehicle is repeatedly accelerated and decelerated at a low speed.
- The fan speed is high.

Models with climate control system

- The climate control system is in use, and there is a significant difference between the set temperature and the actual interior temperature.
- Humidity in the interior is high.

■ The Engine Automatically Restarts When:

The brake pedal is released.

■ The engine restarts even if the brake pedal is depressed when:

- The Auto Idle Stop **OFF** button is pressed.
- A steering wheel is operated.
- The shift lever is set to **R** and **S**, or when it is set from **N** to **D**.
- The pressure to the brake pedal is reduced and the vehicle starts moving while stopped on an incline.
- The pressure on the brake pedal is repeatedly applied and released slightly during a stop.
- The battery charge becomes low.
- The accelerator pedal is depressed.
- The driver's seat belt is unlatched.

Models with climate control system

-  is selected (indicator on).
- The climate control system is in use, and the difference between the set temperature and actual interior temperature becomes significant.
- The climate control system is being used to dehumidify the interior.

Models with heating and cooling system

- The fan is turned on and the mode control dial is turned to .

■ Starting Assist Brake Function

Briefly keeps the brake applied after releasing the brake pedal to restart the engine.

This can keep your vehicle from unexpectedly moving while on an incline.

▶▶ The Engine Automatically Restarts When:

If you are using an electronic device during Auto Idle Stop, the device may temporarily be turned off when the engine restarts.

Manual transmission models

Auto Idle Stop

To help to maximise fuel economy, the engine automatically stops when the vehicle comes to a stop, depending on environmental and vehicle operating conditions. The indicator (green) comes on.

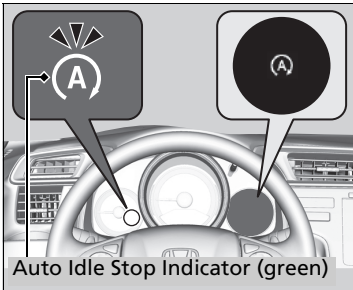

The engine then restarts once the vehicle is about to move again when you depress the clutch pedal, and the indicator (green) goes off.

If the driver's door is opened while the indicator (green) comes on, a buzzer sounds to notify you that the Auto Idle Stop function is in operation.

A message associated with Auto Idle Stop appears on the multi-information display.

- **Indicators** P. 100, 101
- **Multi-Information Display Warning and Information Messages** P. 109
- **Customized Features** P. 129

Auto Idle Stop

If Auto Idle Stop is turned on long enough to lower the battery charge, the engine may not restart automatically. Manually turn off the engine when you leave your vehicle.

The battery installed in this vehicle is specifically designed for a model with Auto Idle Stop. Using a battery other than this specified type may shorten the battery life, and prevent Auto Idle Stop from activating. If you need to replace the battery, make sure to select the specified type. Ask a dealer for more details.

➤ **Specifications** P. 582

■ Auto Idle Stop System ON/OFF

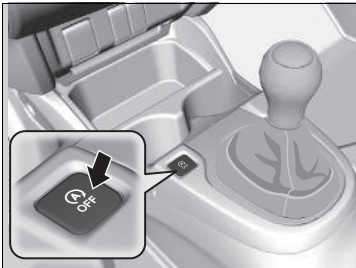

To turn the Auto Idle Stop system off, press this button. The Auto Idle Stop system stops.

- ▶ Auto Idle Stop system will stop and the indicator (amber) will come on.

The Auto Idle Stop system is turned on every time you start the engine, even if you turned it off the last time you drove the vehicle.

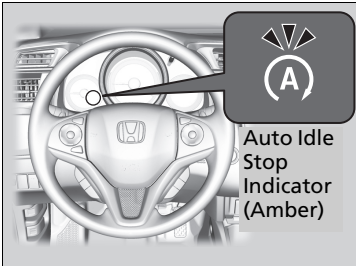

☒ Auto Idle Stop System ON/OFF

Pressing the Auto Idle Stop **OFF** button restarts the engine during the Auto Idle Stop activated.

Auto Idle Stop Activates When:

The Auto Idle Stop is activated after the vehicle has come to a stop and the shift lever is in **N** with the clutch released.

▶ To restart the engine automatically, keep the shift lever in **N**.

Auto Idle Stop does not activate when:

- The driver's seat belt is not fastened.
- The engine coolant temperature is low or high.
- The vehicle comes to a stop again before the vehicle speed reaches 3 km/h (2 mph) after the engine starts.
- The shift lever is in any position except **N**.
- The engine is started with the bonnet open.
 - ▶ Turn off the engine. Close the bonnet before you restart the engine to activate Auto Idle Stop.
-  is on (indicator (amber) on).
- The battery charge is low.
- The internal temperature of the battery is 5°C or less.

Models with climate control system

- The climate control system is in use, and the outside temperature is below -20°C or over 40°C.
- The climate control system is in use, and the temperature is set to **Hi** or **Lo**.
-  is on (indicator on).

Models with heating and cooling system

- The fan is turned on and the mode control dial is turned to .

Auto Idle Stop Activates When:

Do not open a bonnet, during idling stop. If the bonnet is opened, the engine will not restart automatically.

In this case, restart the engine with the **ENGINE START/STOP** button or the ignition switch.

▶ **Starting the Engine** P. 386, 389

Models with keyless access system

Pressing the **ENGINE START/STOP** button changes the power mode to OFF even while Auto Idle Stop is in operation. The engine no longer restarts automatically. Follow the standard procedure to start the engine.

▶ **Starting the Engine** P. 389

Models without keyless access system

Even if you turn the ignition switch to START  during the Auto Idle Stop activated, the engine does not start.

■ **Auto idle stop may not activate when:**

- The steering wheel is operated.
- Altitude is high.

Models with climate control system

- The climate control system is in use, and there is a significant difference between the set temperature and the actual interior temperature.
- Humidity in the interior is high.
- The fan speed is high.

■ **Engine Automatically Restarts When:**

The clutch pedal is depressed.

■ **The engine automatically restarts even if the clutch pedal is not depressed with the shift lever in **[N]** when:**

- The Auto Idle Stop **OFF** button is pressed.
- Your vehicle is moved.
- The pressure on the brake pedal is repeatedly applied and released slightly during a stop.
- The battery charge becomes low.
- The steering wheel is operated.

ⓘ **Engine Automatically Restarts When:**

If there is a problem with the Auto Idle Stop system, the engine does not restart.

In this case, restart the engine with the **ENGINE START/STOP** button or the ignition switch.

➤ **Starting the Engine** P. 386, 389

If you are using an electronic device during Auto Idle Stop, the device may temporarily be turned off when the engine restarts.

During Auto Idle Stop, the engine does not restart automatically if:

- The driver's seat belt is unlatched.
- To keep Auto Idle Stop activated, fasten your seat belt immediately.
- The shift lever is moved to any position except **[N]**.
- Move the shift lever to **[N]** to restart the engine.

➤ **Multi-Information Display Warning and Information Messages** P. 112

If the system is deactivated, restart the engine with the **ENGINE START/STOP** button or the ignition switch.

➤ **Starting the Engine** P. 386, 389

■ When the Auto Idle Stop Indicator (Green) Starts Blinking Rapidly

Fully depress the clutch pedal.

- ▶ The engine automatically restarts.

⌘ When the Auto Idle Stop Indicator (Green) Starts Blinking Rapidly

The indicator starts blinking rapidly under the following conditions:

Models with climate control system

-  (windscreen demister) is touched.
- When the climate control system is in use and moisture builds up inside the vehicle.
- When the climate control system is in use and the difference between the set temperature and the actual temperature inside the vehicle becomes significant.

Models with heating and cooling system

- When the fan is turned on and the mode control dial is turned to .

Cruise Control

Maintains a constant vehicle speed without having to keep your foot on the accelerator. Use cruise control on motorways or open roads where you can travel at a constant speed with little acceleration or deceleration.

⌘ Cruise Control

⚠ WARNING

Improper use of the cruise control can lead to a crash.

Use the cruise control only when travelling on open motorways in good weather.

It may not be possible to maintain a constant speed when driving uphill or downhill.

When not using cruise control:
Turn off cruise control by pressing the **MAIN** button.

You cannot use cruise control and the adjustable speed limiter at the same time.

Manual transmission models

When the engine speed slows down, try to downshift.
You can maintain the set speed if you change gear within five seconds.

When to use

- **Vehicle speed for cruise control:**
Desired speed in a range from about 30 km/h (18 mph) to about 200 km/h (125 mph)

Always keep sufficient distance between you and the vehicle in front of you.

Continuously variable transmission models

- **Shift positions for cruise control:**
In **D** or **S**

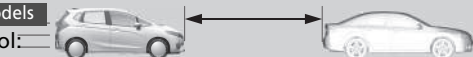

How to use



The indicator is on in the upper part of the multi-information display. Cruise control is ready to use.

- Press the **MAIN** button on the steering wheel.

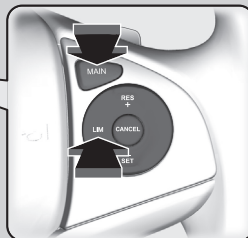

If a different indicator comes on, press the **LIM** button to switch to cruise control.

■ To Set the Vehicle Speed

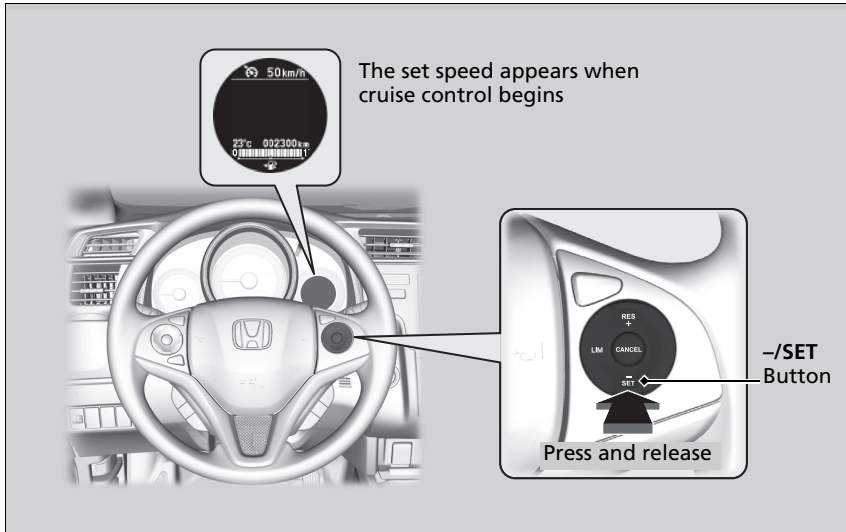

Take your foot off the pedal and press the **-/SET** button when you reach the desired speed.

The moment you release the **-/SET** button, the set speed is fixed, and cruise control begins. The set speed is displayed.

Continued

■ To Adjust the Vehicle Speed

Increase or decrease the vehicle speed using the **RES/+** or **-/SET** buttons on the steering wheel.

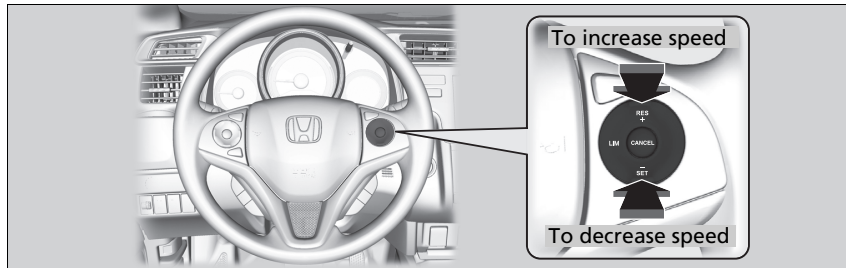

- Each time you press the button, the vehicle speed is increased or decreased by about 1 km/h or 1 mph accordingly.
- If you keep the button pressed, the vehicle speed increases or decreases by about 10 km/h or 10 mph accordingly.

■ To Cancel

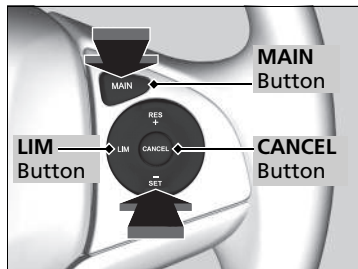

To cancel cruise control, do any of the following:

- Press the **CANCEL** button.
- Press the **MAIN** button.
- Press the **LIM** button.
- Depress the brake pedal.

Manual transmission models

- Depress the clutch pedal for five seconds or more.

The cruise control indicator and displayed set speed go off.

▶▶ To Adjust the Vehicle Speed

You can set the vehicle speed using the **-/SET** button on the steering wheel when adjusting the speed with the accelerator and brake pedals.

▶▶ To Cancel

Resuming the prior set speed:

After cruise control has been cancelled, you can still resume the prior set speed by pressing the **RES/+** button while driving at a speed of at least 30 km/h (18 mph) or more.

You cannot set or resume in the following situations:

- When vehicle speed is less than 30 km/h (18 mph)
- When the **MAIN** button is turned off

At vehicle speeds of 25 km/h (16 mph) or less, cruise control is cancelled automatically.

Adjustable Speed Limiter

This system enables you to set a maximum speed that cannot be exceeded even if you are depressing the accelerator pedal.

The vehicle speed limit can be set from about 30 km/h (18 mph) to about 250 km/h (156 mph).

How to use

The indicator is on in the instrument panel.
Adjustable speed limiter is ready to use.

■ Press the **MAIN** button on the steering wheel

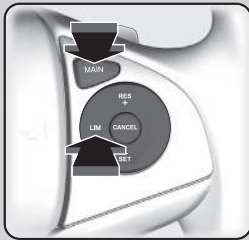

If a different indicator comes on, press the **LIM** button to switch to the adjustable speed limiter.

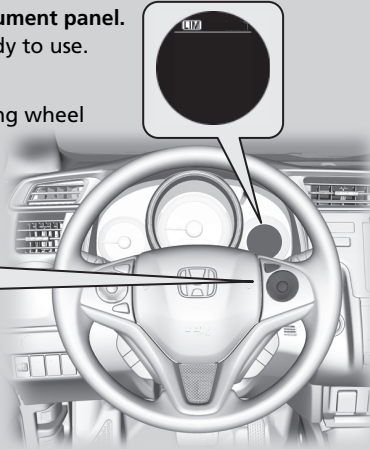

Adjustable Speed Limiter

⚠ WARNING

Adjustable Speed Limiter has limitations. It is always your responsibility to adjust the vehicle speed to obey the actual speed limit, and safely operate the vehicle.

⚠ WARNING

Do not depress the accelerator pedal more than necessary. Maintain an appropriate accelerator pedal position depending on the vehicle speed.

The adjustable speed limiter may not hold the set speed limit when driving downhill. If this occurs, slow down by depressing the brake pedal.

When not using the adjustable speed limiter: Turn off the adjustable speed limiter by pressing the **MAIN** button.

You cannot use the adjustable speed limiter and cruise control or intelligent speed limiter* at the same time.

Manual transmission models

When the engine speed slows down, try to downshift.

* Not available on all models

■ To Set the Speed Limit

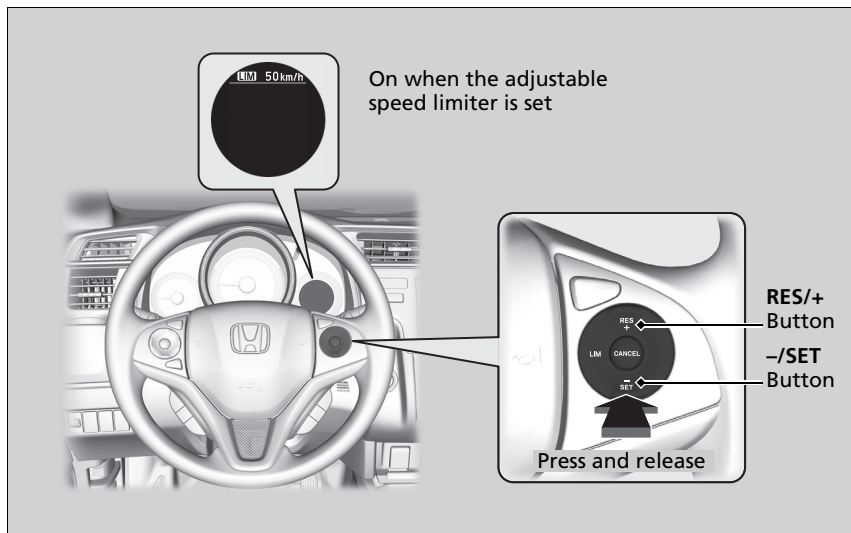

- Take your foot off the pedal and press the **-/SET** button when you reach the desired speed.
The moment you release the **-/SET** button, the speed limit is fixed, and the adjustable speed limiter is set. The speed limit is displayed.
- You can set the previously set speed limit by pressing the **RES/+** button.

▶▶ To Set the Speed Limit

If you set the speed limit while travelling at less than 30 km/h (18 mph), the speed limit is set to 30 km/h (18 mph).

The beeper sounds and the displayed speed limit blinks if the vehicle speed exceeds the limit by 3 km/h (2 mph) or more on a steep descent.

The adjustable speed limiter is set to the current speed if it is higher than the previously set speed limit when you press the **RES/+** button.

■ To Adjust the Speed Limit

Increase or decrease the speed limit by using the **RES/+** or **-/SET** buttons on the steering wheel.

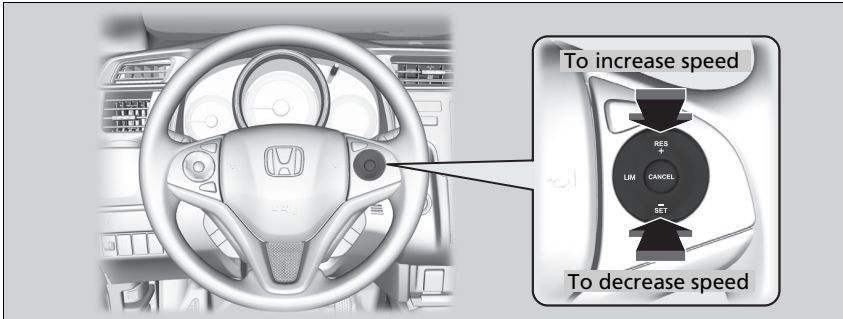

- Each time you press the button, the speed limit is increased or decreased by about 1 km/h or 1 mph accordingly.
- If you keep the button pressed, the speed limit increases or decreases in increments of 10 km/h or 10 mph every 0.5 second until system limit is reached.
- The vehicle may accelerate or decelerate until the set speed is reached.

■ Exceeding the Speed Limit Temporarily

The speed limit can be exceeded by depressing the accelerator pedal fully.

- ▶ The displayed speed limit blinks.
The beeper sounds once the speed limit has been exceeded.

⊠ Exceeding the Speed Limit Temporarily

The beeper sounds when the vehicle speed goes higher than the set speed limit with the acceleration pedal depressed completely.

The adjustable speed limiter resumes working once the vehicle speed goes lower than the set speed limit.

Continued

■ To Cancel

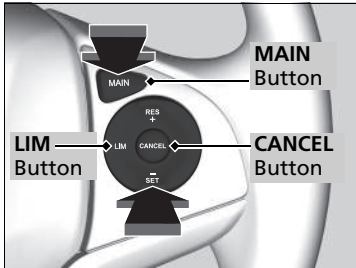

To cancel the adjustable speed limiter, do any of the following:

- Press the **CANCEL** button.
- Press the **MAIN** button.
- Press the **LIM** button.

▶▶ To Cancel

The adjustable speed limiter changes into cruise control if the **LIM** button is pressed.

Models with intelligent speed limiter

The adjustable speed limiter changes into intelligent speed limiter if the **LIM** button is pressed.

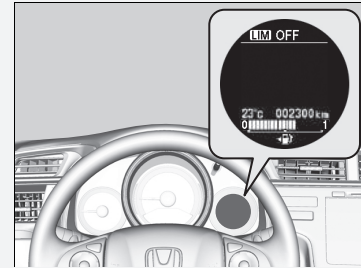

If there is a problem with the system when you are using the adjustable speed limiter, the beeper sounds and **OFF** comes on. The adjustable speed limiter will be turned off.

Models with traffic sign recognition system

Intelligent Speed Limiter

Automatically sets the speed limit that the traffic sign recognition system detects. And the speed limit cannot be exceeded even if you are depressing the accelerator pedal. If you fully depress the accelerator the speed limit can be exceeded.

📄 **Traffic Sign Recognition System*** P. 436

📄 Intelligent Speed Limiter

⚠️ WARNING

Intelligent Speed Limiter has limitations. The intelligent speed limiter may be set to higher or lower speed than the actual speed limit or not work, when the traffic sign recognition system does not operate correctly or there is no speed limit sign. It is always your responsibility to adjust the vehicle speed to obey the actual speed limit, and safely operate the vehicle.

Depending on the amount of depression of the accelerator pedal, the vehicle will accelerate until it reaches the speed identified by the traffic sign recognition system.

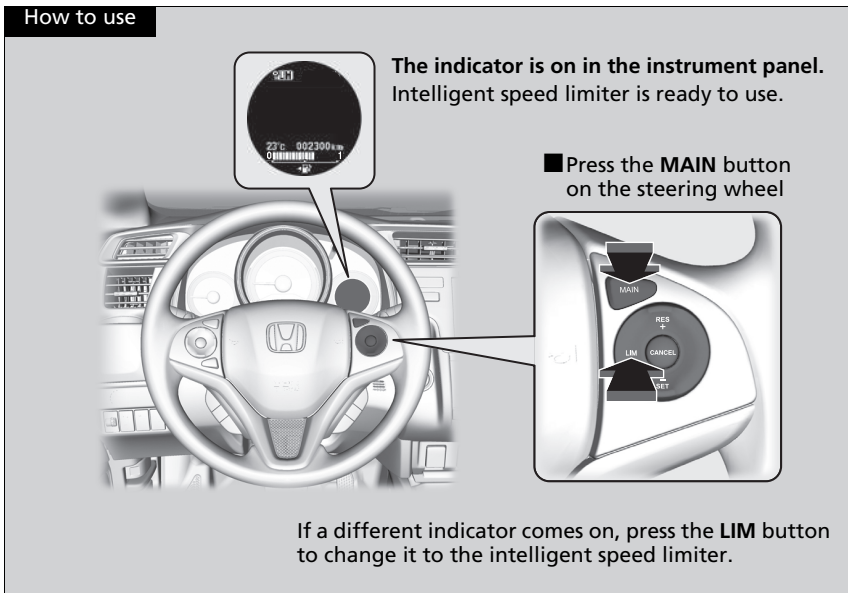

▶ Intelligent Speed Limiter

The system is designed to detect signs that follow the Vienna Convention standards. Not all signs may be detected, but any signs posted on roadsides should not be ignored. The system does not work on the designated traffic signs of all the countries you travel, nor in all situations.

▶ **Traffic Sign Recognition System** * P. 436

If the intelligent speed limiter is set to the wrong speed limit, try one of the following:

To cancel

- Press the **CANCEL** button.
- Press the **MAIN** button.
- Press the **LIM** button.

To exceed the speed limit temporarily

- Depressing the accelerator pedal fully.

The intelligent speed limiter may not hold the set speed limit when driving downhill. If this occurs, slow down by depressing the brake pedal.

When not using the intelligent speed limiter, turn off the intelligent speed limiter by pressing the **MAIN** button.

You cannot use the intelligent speed limiter and cruise control or adjustable speed limiter at the same time.

■ To Set the Speed Limit

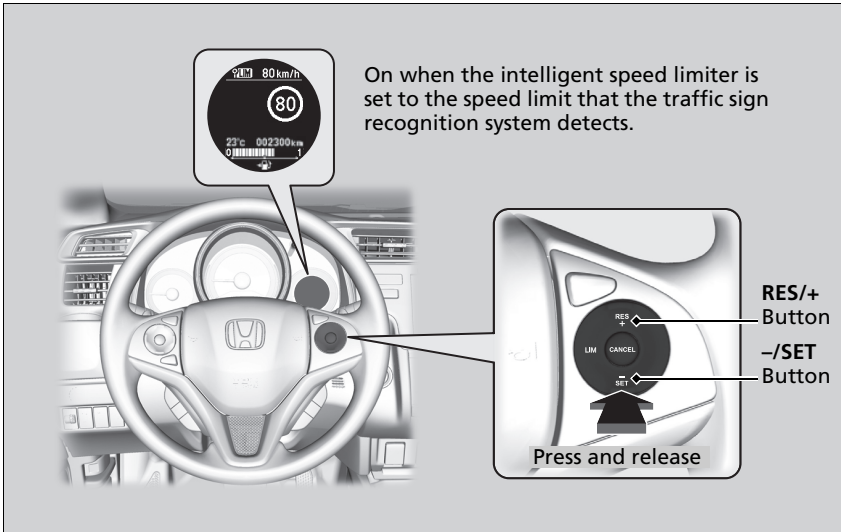

- The moment you release the **-/SET** button or **RES/+** button, the intelligent speed limiter is set to the speed limit that the traffic sign recognition system detects. The speed limit is displayed.

▶▶ Intelligent Speed Limiter

Manual transmission models

When the engine speed slows down, try to downshift.

Do not use the intelligent speed limiter in areas of different units from the display unit of the intelligent speed limiter.

Right-hand drive type

Change the displayed measurement of the set vehicle speed to the same units as the driving areas.

▶ **Customized Features** P. 129

▶▶ To Set the Speed Limit

If you set the intelligent speed limiter when the speed limit that the traffic sign recognition system detects is less than 30 km/h (20 mph), the speed limitation function and warning function may switch to pause.

If your vehicle speed is higher than the speed limit that the traffic sign recognition system detects, your vehicle decelerates slowly to the speed limit or less. If necessary, slow down by depressing the brake pedal. And the beeper sounds and the displayed speed limit blinks if the vehicle speed exceeds the limit by 3 km/h (2 mph) or more.

■ **When the traffic sign recognition system detects the new speed limit sign**

The intelligent speed limiter is set to the new speed limit that the traffic sign recognition system detects.

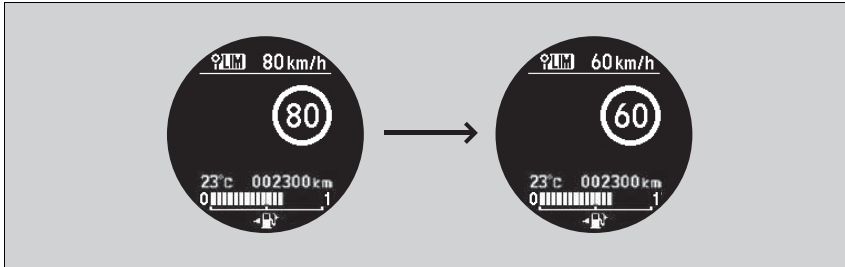

■ **The speed limitation function and warning function may switch to pause if there is no speed limit sign in the screen of the traffic sign recognition system when:**

- The end of speed limit or other designated limit is detected.
- Your vehicle enters/exits motorway or highway.
- You make a turn with a turn signal to change direction at an intersection.

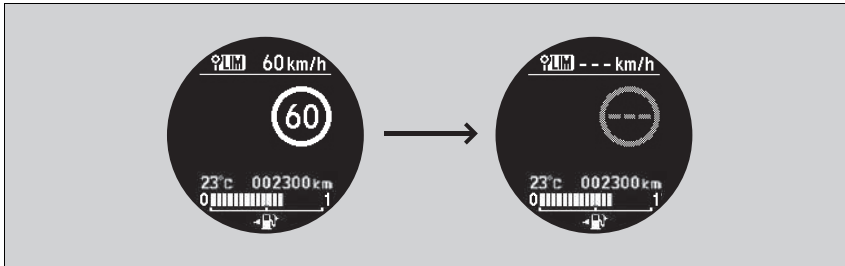

▶▶ To Set the Speed Limit

The intelligent speed limiter may also switch to pause when the traffic sign recognition system detects only additional speed limit signs.

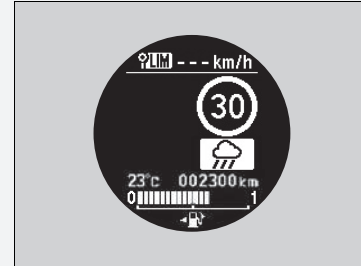

■ **When the traffic sign recognition system detects the speed limit sign while the intelligent speed limiter is paused**

The speed limitation function and warning function will be resumed automatically.

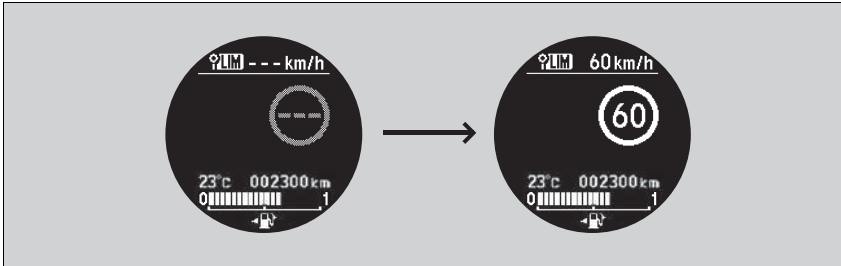

■ **When the traffic sign recognition system does not detect the speed limit sign for a time while the intelligent speed limiter is activated**

While driving, in addition to when the traffic sign recognition system detects no speed limit sign, the traffic sign recognition system may display no speed limit. But, intelligent speed limiter functions continue.

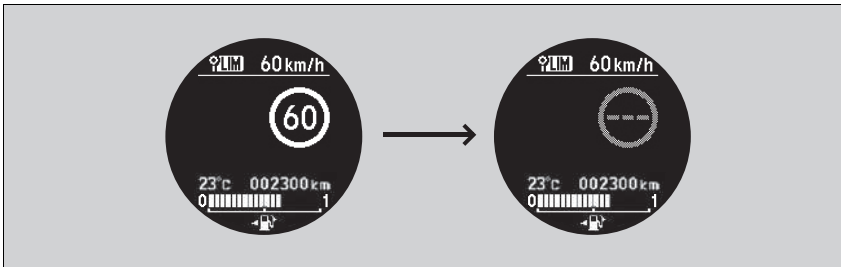

■ To Adjust the Speed Limit

Increase or decrease the speed limit by using the **RES/+** or **-/SET** buttons on the steering wheel.

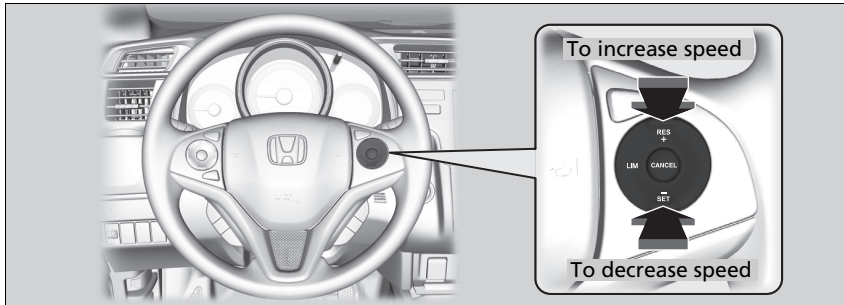

- Each time you press the button, the speed limit is increased or decreased by about 1 km/h or 1 mph accordingly.
- You can increase the speed limit until +10 km/h or +5 mph on the basis of the speed limit that the traffic sign recognition system detects.
- You can decrease the speed limit until -10 km/h or -5 mph on the basis of the speed limit that the traffic sign recognition system detects.
- You can accelerate until the set speed is reached. If your vehicle speed is higher than the speed limit that the traffic sign recognition system detects, your vehicle decelerates slowly to the speed limit.

■ Exceeding the Speed Limit Temporarily

The speed limit can be exceeded by depressing the accelerator pedal fully.

- ▶ The displayed speed limit blinks.
The beeper sounds once the speed limit has been exceeded.

▶▶ To Adjust the Speed Limit

A negative or positive offset with respect to the speed limit will be reset automatically when the traffic sign recognition system detects the new speed limit sign.

You cannot decrease the speed limit less than 30 km/h (18 mph).

▶▶ Exceeding the Speed Limit Temporarily

The beeper sounds when the vehicle speed goes higher than the set speed limit with the acceleration pedal depressed completely.

The intelligent speed limiter resumes working once the vehicle speed goes lower than the set speed limit.

To Cancel

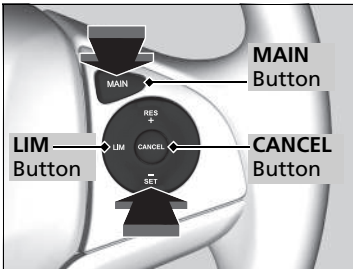

To cancel the intelligent speed limiter, do any of the following:

- Press the **CANCEL** button.
- Press the **MAIN** button.
- Press the **LIM** button.

To Cancel

The intelligent speed limiter changes into cruise control if the **LIM** button is pressed.

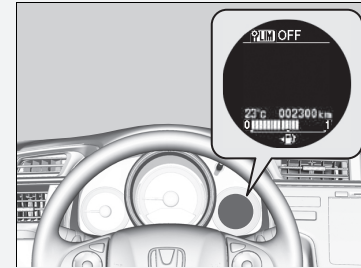

If there is a problem with the system or traffic sign recognition system when you are using the intelligent speed limiter, the beeper sounds and **OFF** comes on. The intelligent speed limiter will be turned off.

➤ **Traffic Sign Recognition System*** P. 436

* Not available on all models

Forward Collision Warning*

Alerts you when it detects the possibility of your vehicle colliding with the vehicle in front of yours.

If the system determines a collision is possible, it gives both visual and audible alerts.

- ▶ Take appropriate action to prevent a collision (apply the brakes, change lanes, etc.).

■ How the system works

The system may give warnings of potential collisions when your vehicle speed is above 15 km/h (9 mph).

You can set **Far**, **Normal** or **Near** for when warnings start:

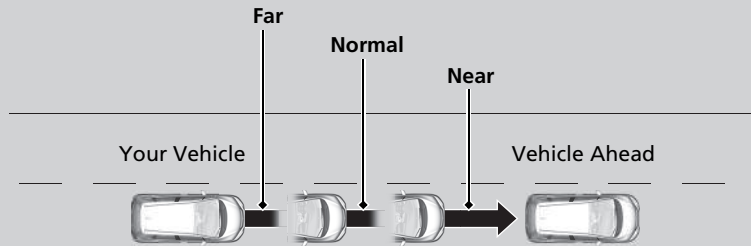

⚠ Forward Collision Warning*

Important Safety Reminder

Forward Collision Warning cannot detect all objects ahead and may not detect a given object; accuracy of the system will vary based on weather, speed and other factors. Forward Collision Warning does not include a braking function. It is always your responsibility to safely operate the vehicle and avoid collisions.

You can change the Forward Collision Warning Distance setting or turn the system on and off.

🔧 **Customized Features** P. 129

The camera is shared with Lane Departure Warning, Traffic Sign Recognition System and High beam Support System.

For the system's proper operation:

- Do not impact the camera or the area around the camera when you clean the windshield.
- Keep the upper windshield clean. Wipe away any debris including ice and frost.

Consult a dealer in the following cases.

- The camera or the area around the camera is severely impacted.
- The area around the windshield needs repair.

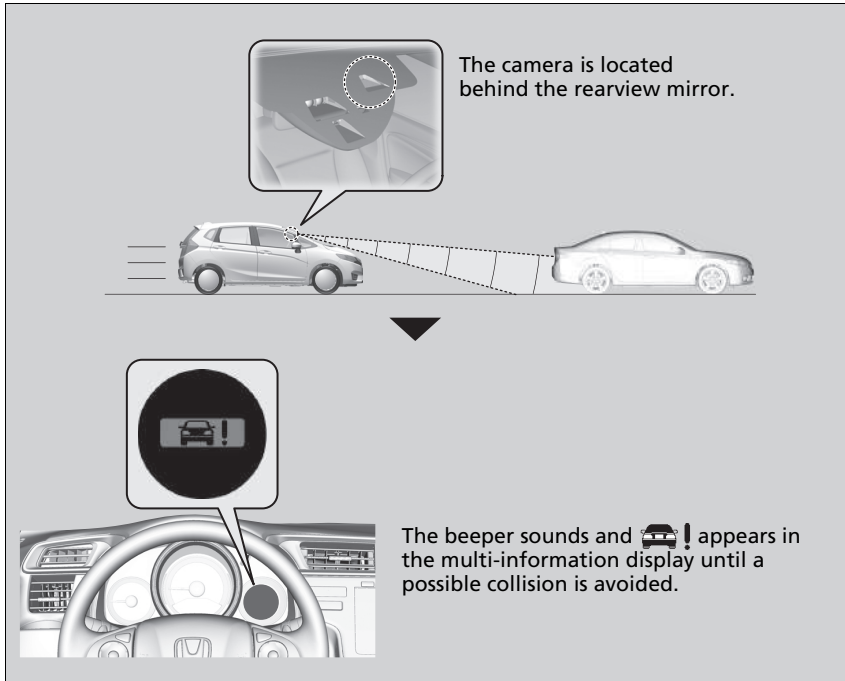

⊠ Forward Collision Warning*

Never apply a film or attach any objects to the windshield that could obstruct the Forward Collision Warning camera's field of vision. Scratches, nicks, and other damage to the windshield within the Forward Collision Warning camera's field of vision can cause the system to operate abnormally. If this occurs, we recommend that you replace the windshield with a genuine Honda replacement windshield. Making even minor repairs within the camera's field of vision or installing an aftermarket replacement windshield may also cause the system to operate abnormally. After replacing the windshield, have a dealer recalibrate the camera. Proper calibration of the Forward Collision Warning camera is necessary for the system to operate properly.

* Not available on all models

■ Automatic shutoff

Forward Collision Warning may automatically shut itself off and the  indicator comes and stays on when:

- The temperature inside the system is high.
- The windscreen is blocked by dirt, mud, leaves, wet snow, etc.

Once the conditions that caused Forward Collision Warning to shut off improve or are addressed (e.g., cleaning), the system comes back on.

▶ Automatic shutoff

To help to reduce the likelihood that high interior temperatures will cause the camera system to shut off, when parking, find a shady area or face the front of the vehicle away from the sun.

If you use a reflective sun shade, do not allow it to cover the camera housing. Covering the camera can concentrate heat on the camera.

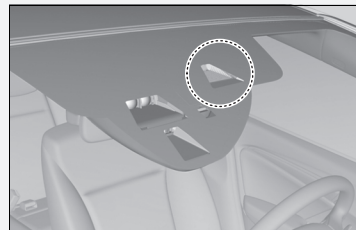

If the system cannot operate:  appears:

- Use the heating and cooling system*/climate control system* to cool down the interior and, if necessary, the demister mode when windows are fogged.
- Start driving the vehicle to lower the windscreen temperature, which cools down the area around the Forward Collision Warning camera.

If the system cannot operate:  appears:

Park your vehicle in a safe place. Wipe away debris blocking the windscreen, then start driving again. If the symbol remains on even after driving for a while with the clean windscreen, have your vehicle checked by a dealer.

■ Forward Collision Warning Limitations

Forward Collision Warning may not activate or may not detect a vehicle in front of your vehicle, and may activate even when you are aware of a vehicle ahead of you, or when there is no vehicle ahead, under the following conditions.

Condition

- The distance between your vehicle and the vehicle ahead of you is too short.
- A vehicle cuts in front of you at a slow speed, and it brakes suddenly.
- A vehicle suddenly crosses in front of you.
- When either your vehicle or the vehicle ahead of you accelerates rapidly.
- The vehicle ahead of you is a motorcycle, a small vehicle, or a unique vehicle such as a tractor.
- When you drive off-road or on a mountain road, or curved and winding road for an extended period that makes it difficult for the camera to properly detect a vehicle in front of you.
- When there are pedestrians or animals in front of your vehicle.
- When you drive in bad weather (rain, fog, etc.).
- A heavy load in the rear or modifications to the suspension tilts your vehicle.
- An abnormal tyre condition is detected (wrong tyre size, flat tyre, etc.).
- When the windscreen is blocked by dirt, mud, leaves, wet snow, etc.
- When the temperature inside the system is high.
- A sudden change between light and dark such as an entrance or exit of a tunnel.
- You drive into the sunlight (e.g. at dawn or dusk).
- When the windscreen is dirty or cloudy.
- When streetlights are perceived as the taillight of a vehicle in front of yours.
- When driving at night, the vehicle ahead of you is running with either taillight bulb burned out.
- When you drive in the shadows of trees, buildings, etc.
- When your vehicle is towing a trailer.

Lane Departure Warning*

Alerts you when the system detects a possibility of your vehicle unintentionally crossing over left or right side lane markings.

How the System Works

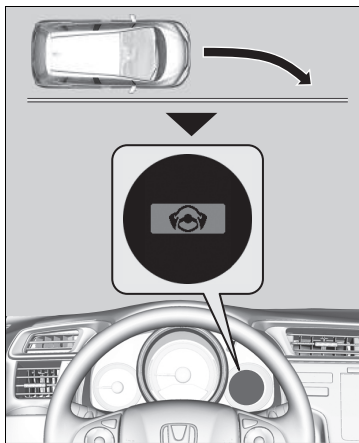

If your vehicle is getting too close to detected left or right side lane markings without a turn signal activated, Lane Departure Warning will give audible and visual alerts.

The beeper sounds and  appears on the multi-information display, letting you know that you need to take appropriate action.

How the System Activates

The system begins to search for lane markings when all the following conditions are met:

- The vehicle is travelling above 72 km/h (45 mph).
- The vehicle is on a straight or slightly curved road.
- The turn signals are off.
- The brake pedal is not depressed.

ⓘ Lane Departure Warning*

Important Safety Reminder

Like all assistance systems, Lane Departure Warning has limitations.

Over-reliance on Lane Departure Warning may result in a collision. It is always your responsibility to keep the vehicle within your driving lane.

Lane Departure Warning only alerts you when lane drift is detected without a turn signal in use. Lane Departure Warning may not detect all lane markings or lane departures; accuracy will vary based on weather, speed and lane marker condition. It is always your responsibility to safely operate the vehicle and avoid collisions.

The Lane Departure Warning may not work properly or may work improperly under the certain conditions:

➔ **Lane Departure Warning Conditions and Limitations** P. 434

ⓘ How the System Activates

Lane Departure Warning may automatically shut off and the  indicator comes and stays on.

➔ **Indicators** P. 103

■ Lane Departure Warning Camera

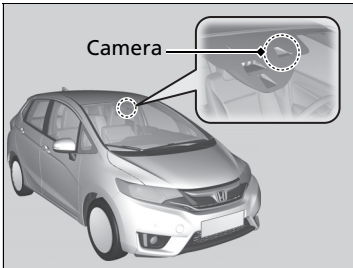

The camera is located behind the rearview mirror.

■ Lane Departure Warning On and Off

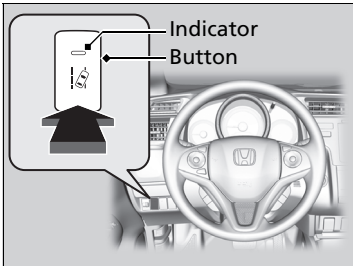

Press the Lane Departure Warning button to turn the system on and off.

- ▶ The indicator in the button comes on when the system is on.

▣ Lane Departure Warning Camera

Never apply a film or attach any objects to the windshield that could obstruct the Lane Departure Warning camera's field of vision.

Scratches, nicks, and other damage to the windshield within the Lane Departure Warning camera's field of vision can cause the system to operate abnormally. If this occurs, we recommend that you replace the windshield with a genuine Honda replacement windshield. Making even minor repairs within the camera's field of vision or installing an aftermarket replacement windshield may also cause the system to operate abnormally.

After replacing the windshield, have a dealer recalibrate the camera. Proper calibration of the Lane Departure Warning camera is necessary for the system to operate properly.

Do not place an object on the top of the instrument panel. It may reflect onto the windshield and prevent the system from detecting lane lines properly.

To help to reduce the likelihood that high interior temperatures will cause the camera system to shut off, when parking, find a shady area or face the front of the vehicle away from the sun.

If you use a reflective sun shade, do not allow it to cover the camera housing. Covering the camera can concentrate heat on the camera.

■ Lane Departure Warning Conditions and Limitations

The system may not properly detect lane markings and the position of your vehicle under certain conditions. Some examples of these conditions are listed below.

■ Environmental conditions

- Driving in bad weather (rain, fog, snow, etc.).
- Sudden changes between light and dark, such as an entrance or exit of a tunnel.
- There is little contrast between lane lines and the roadway surface.
- Driving into low sunlight (e.g., at dawn or dusk).
- Strong light is reflected onto the roadway.
- Driving in the shadows of trees, buildings, etc.
- Shadows of adjacent objects are parallel to lane markings.
- Roadway objects or structures are misinterpreted as lane markers.
- Reflections on the interior of the front windscreen.

▶ Lane Departure Warning Camera

If the  message appears:

- Use the heating and cooling system*/climate control system* to cool down the interior and, if necessary, the demister mode when windows are fogged.
- Start driving the vehicle to lower the windscreen temperature, which cools down the area around the Lane Departure Warning camera.

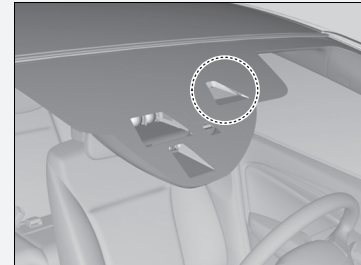

If the  message appears:

Park your vehicle in a safe place. Wipe away debris blocking the windscreen, then start driving again. If the message remains on even after driving for a while with the clean windscreen, have your vehicle checked by a dealer.

■ Roadway conditions

- Driving on a snowy or wet roadway (obscured lane marking, vehicle tracks, reflected lights, road spray, high contrast).
- Driving on a road with temporary lane markings.
- Faint, multiple, or varied lane markings are visible on the roadway due to road repairs or old lane markings.
- The roadway has merging, split, or crossing lines (e.g., such as at an intersection or crosswalk).
- The lane markings are extremely narrow, wide, or changing.
- The vehicle in front of you is driving near the lane lines.
- The road is hilly or the vehicle is approaching the crest of a hill.
- Driving on rough or unpaved roads, or over bumpy surfaces.
- When objects on the road (curb, guard rail, pylons, etc.) are recognised as white lines (or yellow lines).
- When driving on roads with double lines.

■ Vehicle conditions

- Headlight lenses are dirty or the headlights are not properly adjusted.
- The outside of the windscreen is streaked or blocked by dirt, mud, leaves, wet snow, etc.
- The inside of the windscreen is fogged.
- The camera temperature gets too hot.
- An abnormal tyre or wheel condition (wrong sized, varied size or construction, improperly inflated, compact spare tyre*, etc.).
- The vehicle is tilted due to a heavy load or suspension modifications.
- When tyre chains are installed.

* Not available on all models

Traffic Sign Recognition System*

Reminds you of road sign information, such as the current speed limit and that overtaking is prohibited, your vehicle has just passed through, showing it on the multi-information display.

How the System Works

When the camera located behind the rearview mirror captures traffic signs while driving, the system displays the ones that are recognised as designated for your vehicle. The sign icon will be displayed for a while, then until the vehicle reaches a predetermined time and distance.

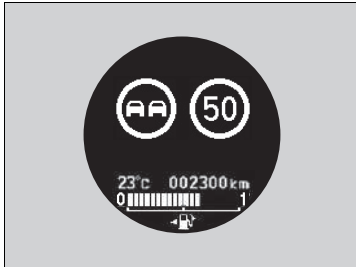

The sign icon also may switch to another one, or disappear when:

- The end of speed limit or other designated limit is detected.
- Your vehicle enters/exits motorway or highway.
- You make a turn with a turn signal to change direction at an intersection.

Traffic Sign Recognition System*

The system is designed to detect signs that follow the Vienna Convention standards. Not all signs may be displayed, but any signs posted on roadsides should not be ignored.

The Traffic Sign Recognition System is designed to merely provide driving assistance. The driver must still be aware of the road conditions and comply with all road regulations. Certain conditions, such as below, may disrupt the system's proper operations.

- The upper part of the windscreen is fogged or frosted, or is blocked by dirt, mud, leaves, wet snow, etc.
- Dew condensation is formed on the windscreen.

While driving, in addition to when there is no detected sign, you may also see the below screen when.

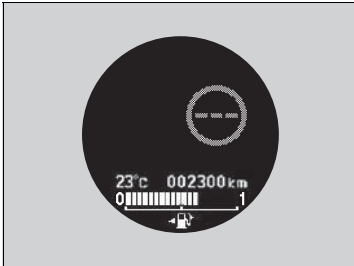

Condition

- The sign is covered with dirt, snow, or frost.
- The ambient brightness is too dark.
- In bad weather (heavy rain, fog, snow, etc.)
- Faded signs
- Signs positioned on bends
- Rotated or damaged signs
- Concealed or poorly positioned signs
- When the windscreen is blocked by dirt, mud, leaves, wet snow, etc.
- When the temperature inside the system is high.
- A sudden change between light and dark such as an entrance or exit of a tunnel.
- You drive into the sunlight (e.g. at dawn or dusk).
- When the windscreen is dirty or cloudy.
- When you drive in the shadows of trees, buildings, etc.

* Not available on all models

⊠ Traffic Sign Recognition System*

If the system cannot operate:  appears:

- Use the heating and cooling system*/climate control system* to cool down the interior and, if necessary, the demister mode when windows are fogged.
- Start driving the vehicle to lower the windscreen temperature, which cools down the area around the system camera.

If the system cannot operate:  appears:

Park your vehicle in a safe place. Wipe away debris blocking the windscreen, then start driving again. If the symbol remains on even after driving for a while with the clean windscreen, have your vehicle checked by a dealer.

If  appears in amber on the multi-information display while driving, the system may have malfunctioned.

Have your vehicle checked by a dealer.

In a situation above, you may also see this icon. The system is temporarily cancelled.

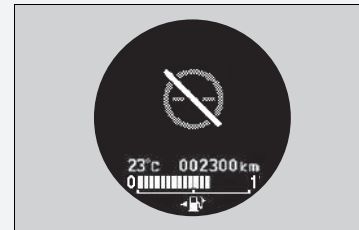

Continued

■ Signs Displayed on the Multi-Information Display

Two traffic signs can be simultaneously displayed next to each other when detected. The speed limit sign icon is displayed on the right half of the screen. The overtaking prohibition sign appears on the left. Any additional sign that indicates speed limit based on weather (rain, snow, etc.) or specific period of time can appear on either side.

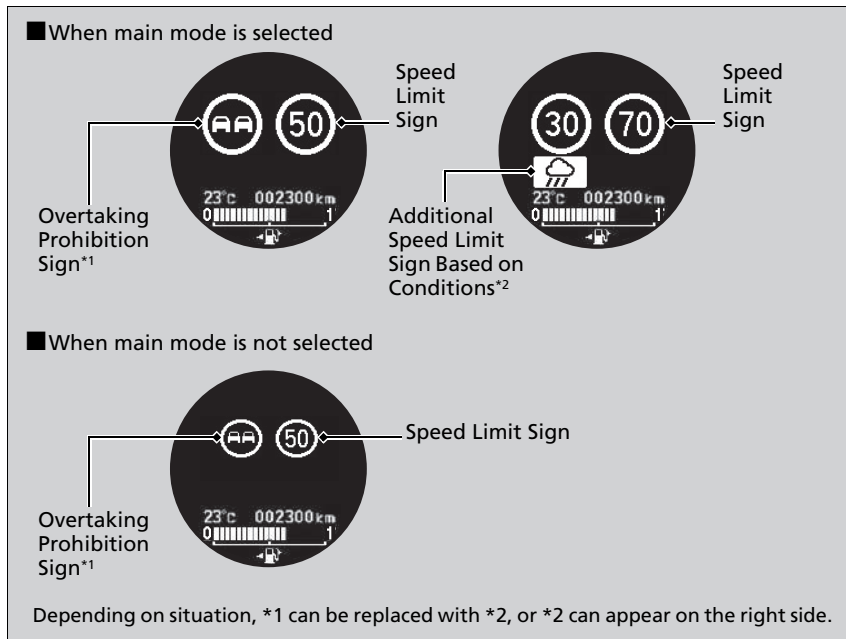

■ Selecting to display traffic signs when main mode is off

You can continue displaying reduced-size traffic sign icon on the multi-information display even while the main mode is not selected.

🗨 **Customized Features** P. 129

Vehicle Stability Assist (VSA) System

VSA helps to stabilize the vehicle during cornering if the vehicle turns more or less than what was intended. It also assists in maintaining traction on slippery surfaces. It does so by regulating engine output and selectively applying the brakes.

VSA Operation

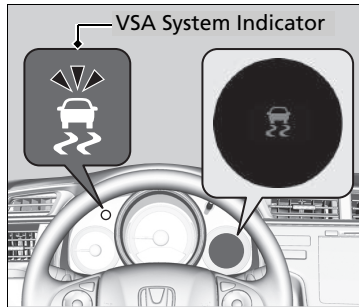

When VSA activates, you may notice that the engine does not respond to the accelerator. You may also notice some noise from the hydraulic system. You will also see the indicator blink.

Vehicle Stability Assist (VSA) System

The VSA may not function properly if tyre type and size are mixed. Make sure to use the same size and type of tyre, and the air pressures as specified.

When the VSA indicator comes on and stays on while driving, there may be a problem with the system. While this may not interfere with normal driving, have your vehicle checked by a dealer immediately.

VSA cannot enhance stability in all driving situations and does not control the entire braking system. You still need to drive and corner at speeds appropriate for the conditions and always leave a sufficient margin of safety.

VSA OFF Button

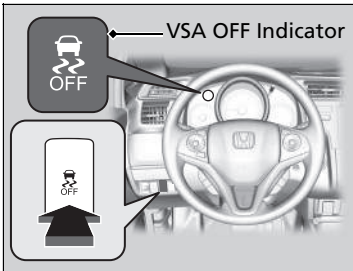

This button is on the driver side control panel. To partially turn the VSA features on and off, press and hold it until you hear a beep.

The traction control stops fully functioning, allows the wheels to spin more freely at low speed. The VSA OFF indicator will also come on.

To turn it on again, press the  (VSA **OFF**) button until you hear a beep.

VSA is turned on every time you start the engine, even if you turned it off the last time you drove the vehicle.

Vehicle Stability Assist (VSA) System

With the  button pressed, your vehicle will have normal braking and cornering ability, but VSA traction and stability enhancement becomes less effective.

In certain unusual conditions when your vehicle gets stuck in shallow mud or fresh snow, it may be easier to free it with the VSA temporarily switched off.

When the  button is pressed, the traction control function becomes less effective. This allows for the wheels to spin more freely at low speed. You should only attempt to free your vehicle with the VSA off if you are not able to free it when the VSA is on.

Immediately after freeing your vehicle, be sure to switch VSA on again. We do not recommend driving your vehicle with the VSA system switched off.

You may hear a motor sound coming from the engine compartment while system checks are being performed immediately after starting the engine or while driving. This is normal.

Agile Handling Assist System

Lightly brakes each of the front and rear wheels, as needed, when you turn the steering wheel, and helps support the vehicle's stability and performance during cornering.

ⓘ Agile Handling Assist System

The agile handling assist system cannot enhance stability in all driving situations. You still need to drive and corner at speeds appropriate for the conditions and always leave a sufficient margin of safety.

When the VSA system indicator comes on and stays on while driving, the agile handling assist system does not activate.

You may hear a sound coming from the engine compartment while the system is activated. This is normal.

Deflation Warning System

Instead of directly measuring the pressure in each tyre, the deflation warning system on this vehicle monitors and compares the rolling radius and rotational characteristics of each wheel and tyre while you are driving to determine if one or more tyres are significantly under-inflated. This will cause the low tyre pressure/deflation warning system indicator to come on and a symbol to appear on the multi-information display.

Deflation Warning System Calibration

You must start deflation warning system calibration every time you:

- Adjust the pressure in one or more tyres.
- Rotate the tyres.
- Replace one or more tyres.

Before calibrating the deflation warning system:

- Set the cold tyre pressure in all four tyres.

Make sure:

- The vehicle is at a complete stop.

Manual transmission models

- The parking brake is applied.

Continuously variable transmission models

- The shift lever is in **P**.

All models

- The ignition switch is in ON **II***1.

*1: Models with the keyless access system have an **ENGINE START/STOP** button instead of an ignition switch.

* Not available on all models

Deflation Warning System

The system does not monitor the tyres when driving at low speed.

Conditions such as low ambient temperature and altitude change directly affect tyre pressure and can trigger the low tyre pressure/deflation warning system indicator to come on.

Tyre pressure checked and inflated in:

- Warm weather can become under-inflated in colder weather.
- Cold weather can become over-inflated in warmer weather.

The low tyre pressure indicator will not come on as a result of over inflation.

The deflation warning system may not function properly if tyre type and size are mixed.

Make sure to use the same size and type of tyre.

Checking and Maintaining Tyres P. 508

The low tyre pressure/deflation warning system indicator may come on with a delay or may not come on at all when:

- You rapidly accelerate, decelerate, or turn the steering wheel.
- You drive on snowy or slippery roads.
- Snow chains are used.

The low tyre pressure/deflation warning system indicator may come on under the following conditions:

- A compact spare tyre* is used.
- There is a heavier and uneven load on the tyres, such as when towing a trailer, than the condition at calibration.
- Snow chains are used.

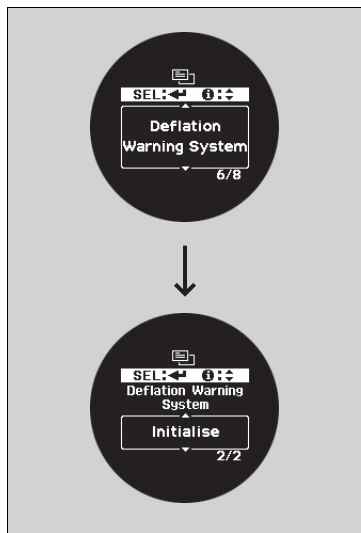

You can calibrate the system from the customized features on the multi-information display.

1. Press the button until (customize settings) appears on the display, then press the **SEL/RESET** button.
2. Press the button until **Deflation Warning System** appears on the display, then press the **SEL/RESET** button.
 - ▶ The display switches to the customization setup screen, where you can select **Cancel** or **Initialise**.
3. Press the button and select **Initialise**, then press the **SEL/RESET** button.
 - ▶ **Completed** screen appears, then the display returns to the customization menu screen.
4. Press the button until (Exit) appears on the display, then press the **SEL/RESET** button.
 - The display returns to the normal screen.
 - The calibration process finishes automatically.

▶▶ Deflation Warning System Calibration

- Deflation Warning System cannot be calibrated if a compact spare tyre* is installed.
- The calibration process requires approximately 30 minutes of cumulative driving at speeds between 40–100 km/h (25–62 mph).
- During this period, if the ignition switch*1 is turned on and the vehicle is not moved within 45 seconds, you may notice the low tyre pressure indicator comes on briefly. This is normal and indicates that the calibration process is not yet complete.

If the snow chains are installed, remove them before calibrating the deflation warning system.

If the low tyre pressure/deflation warning system indicator comes on even when the properly inflated specified regular tyres are installed, have the vehicle checked by a dealer.

We recommend that the tyres be replaced with the same brand, model, and size as the originals. Ask a dealer for details.

*1 : Models with the keyless access system have an **ENGINE START/STOP** button instead of an ignition switch.

* Not available on all models

Adjusting Headlight Distribution

Driving the right-hand type vehicle in right-hand traffic, or the left-hand type vehicle in left-hand traffic causes headlight glare to oncoming vehicles. You need to alter the headlight beam distribution using masking tape.

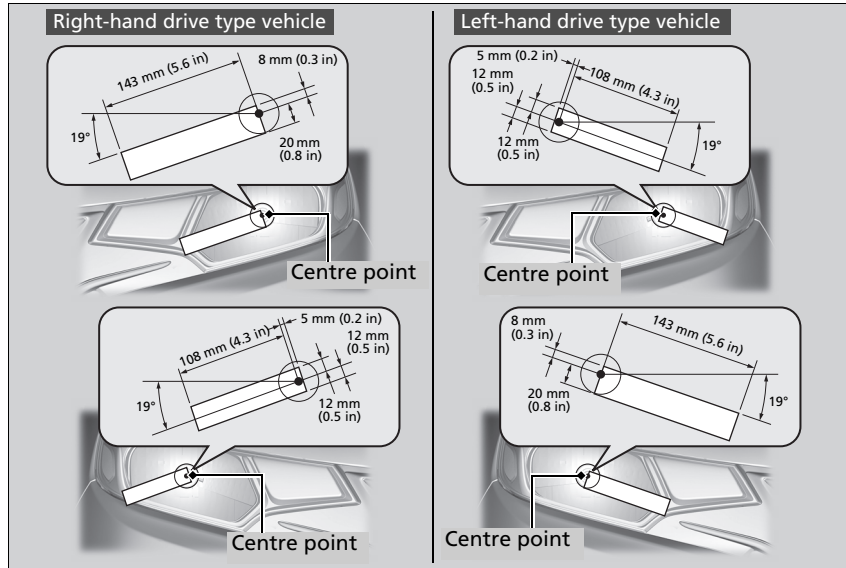

1. Prepare for two rectangular pieces of masking tape, measuring 24 mm (0.9 in) wide and 113 mm (4.4 in) long, and 28 mm (1.1 in) wide and 143 mm (5.6 in) long.
 - ▶ Use masking tape that can shut out light, such as seal type waterproof vinyl.
2. Affix the tape to the lens as shown.
 - ▶ The label is inclined downward at 19°.

Adjusting Headlight Distribution

Be careful not to adhere the tape to an incorrect location. If the headlight beam is distributed incorrectly, it may not comply with your country's legal requirements. Ask your dealer for details.

Brake System

■ Parking Brake

Use the parking brake to keep the vehicle stationary when parking.

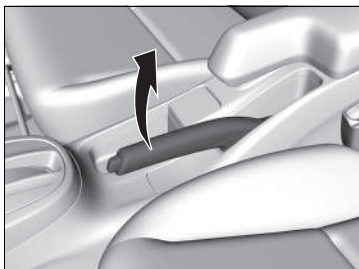

To apply:

Pull the lever fully up without pressing the release button.

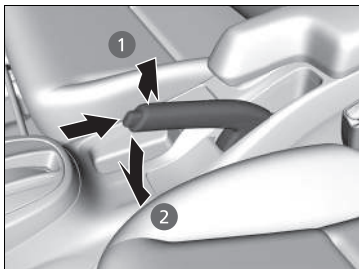

To release:

1. Pull the lever slightly, and press and hold the release button.
2. Lower the lever down all the way, then release the button.

» Parking Brake

NOTICE

Release the parking brake fully before driving. The rear brakes and axle can be damaged if you drive with the parking brake applied.

If you start driving without fully releasing the parking brake, a buzzer sounds as a warning, and **(P)** appears on the multi-information display.

Always apply the parking brake when parking.

Foot Brake

Your vehicle is equipped with disc brakes at all four wheels. A vacuum power assist helps to reduce the effort needed on the brake pedal. The brake assist system increases the stopping force when you depress the brake pedal hard in an emergency situation. The anti-lock brake system (ABS) helps you to retain steering control when braking very hard.

➤ **Brake Assist System** P. 449

➤ **Anti-lock Brake System (ABS)** P. 448

Foot Brake

Check the brakes after driving through deep water, or if there is a buildup of road surface water. If necessary, dry the brakes by lightly depressing the pedal several times.

If you hear a continuous metallic friction sound when applying the brakes, the brake pads need to be replaced. Have the vehicle checked by a dealer.

Constantly using the brake pedal while going down a long hill builds up heat, which reduces the brake effectiveness. Apply engine braking by taking your foot off the accelerator pedal and downshifting to a lower gear/speed position. With manual transmission use a lower gear for greater engine braking.

Do not rest your foot on the brake pedal while driving, as it will lightly apply the brakes and cause them to lose effectiveness over time and reduce pad life. It will also confuse drivers behind you.

Anti-lock Brake System (ABS)

■ ABS

Helps to prevent the wheels from locking up, and helps you retain steering control by pumping the brakes rapidly, much faster than you.

The electronic brake distribution (EBD) system, which is part of the ABS, also balances the front-to-rear braking distribution according to vehicle loading.

You should never pump the brake pedal. Let the ABS work for you by always keeping firm, steady pressure on the brake pedal. This is sometimes referred to as “stomp and steer.”

■ ABS operation

The brake pedal may pulsate slightly when the ABS is working. Keep holding the pedal firmly down. On dry pavement, you will need to press on the brake pedal very hard before the ABS activates. However, you may feel the ABS activate immediately if you are trying to stop on snow or ice.

When the vehicle speed goes under 10 km/h, the ABS stops.

►► Anti-lock Brake System (ABS)

NOTICE

The ABS may not function correctly if you use an incorrect tyre type and size.

When the **ABS** indicator comes on while driving, there may be a problem with the system. While normal braking is not affected, there is a possibility of the ABS not operating. Have your vehicle checked by a dealer immediately.

The ABS does not reduce the time or distance it takes to stop the vehicle. It only helps with steering control during hard braking.

In the following cases, your vehicle may need more stopping distance than a vehicle without the ABS:

- When driving on rough road surfaces, including when driving on uneven surfaces, such as gravel or snow.
- When tyre chains are installed.

You may hear a motor sound coming from the engine compartment while system checks are being performed immediately after starting the engine or while driving. This is normal.

Brake Assist System

■ Brake Assist System

Designed to assist the driver by generating greater braking force when you depress the brake pedal hard during emergency braking.

■ Brake assist system operation

Press the brake pedal firmly for more powerful braking.

When brake assist operates, the pedal may wiggle slightly and an operating noise may be heard. This is normal. Keep holding the brake pedal firmly down.

City-Brake Active system

Can assist you when driving at a low speed, and there is a possibility of your vehicle colliding with a vehicle detected right in front of yours. The City-Brake Active system is designed to alert you when a potential collision is determined, as well as to reduce your vehicle speed when a collision is deemed unavoidable to help to minimise collision severity.

How the System Works

A laser sensor starts to monitor if there is a vehicle in front of you when your vehicle speed is between about 5 km/h (3 mph) and about 32 km/h (20 mph).

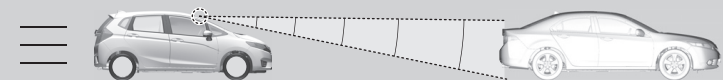

Laser Sensor
The laser sensor is behind the rearview mirror.

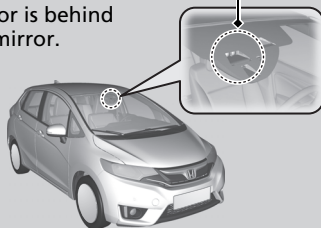

The system activates when the speed difference between your vehicle and a vehicle detected in front of you is about 5 km/h (3 mph) to 32 km/h (20 mph) with a high chance of collision.

The system don't activate when shift position is **R**.

City-Brake Active system

⚠ WARNING

Do not rely on the city-brake active system to avoid every possible frontal collision.

Failure to pay close attention to a vehicle ahead of you, and to operate the brake pedal appropriately according to the situation can cause serious injury or death.

For the system to work properly:

- Always keep the upper part of the windscreen clean. Wipe away any dirt, ice, frost, etc.
- Do not impact the area around the laser sensor when cleaning the windscreen.
- Do not remove the laser sensor form the unit.

Manual transmission models

When the vehicle comes to a stop with the system's automatic braking, the engine may stop. To start the engine again, follow the standard procedure.

➤ **Starting the Engine** P. 386, 389

Collision Alert Stages

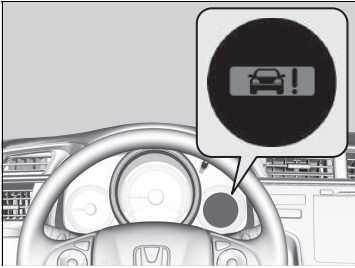

The beeper sounds, and a CTBA warning blinks on the multi-information display, and hard braking is applied when a possible collision becomes likely unavoidable. This automatic braking with the system activated is cancelled after the vehicle comes to a complete stop.

Apply the brakes accordingly. A symbol indicating that the system has activated appears on the multi-information display after the vehicle is stopped.

📄 Multi-Information Display Warning and Information Messages P. 108

The system may be cancelled if you operate the brake pedal, the accelerator pedal, or the steering wheel to avoid the collision.

📄 City-Brake Active system

The system may not activate or may not detect a vehicle in front of your vehicle under the following conditions:

- A vehicle in front of you is diagonally, horizontally, or frontally positioned.
- The distance between your vehicle and the vehicle ahead of you is too short.
- The speed difference between your vehicle and a vehicle ahead of you is large.
- A vehicle cuts in front of you, and brakes suddenly.
- You rapidly accelerate your vehicle, getting closer to a vehicle ahead.
- An oncoming vehicle suddenly drifts in front of you.
- Your vehicle suddenly drifts into the oncoming lane.
- A vehicle suddenly crosses in front of you at intersections.
- When driving in bad weather (heavy rain, fog, snow, etc.).
- When driving on a curved or winding road.
- A vehicle in front of you is extremely dirty, making it difficult to reflect radio waves well.
- You depress the brake pedal or turn the steering wheel to avoid a collision.
- A vehicle ahead of you is a motorcycle or other small vehicle the sensor cannot detect properly.
- The upper part of the windshield around the laser sensor is covered with dirt, ice frost, etc.

The system may not activate while you are fully depressing the accelerator pedal.

Continued

■ The System On and Off

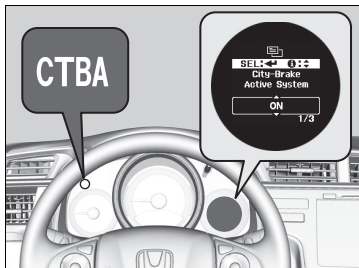

You can turn the system on and off using the multi-information display.

➤ **Customized Features** P. 129

When the system is off, the **CTBA** indicator in the instrument panel comes on.

City-Brake Active system is turned on every time you turn the ignition switch to ON **II**^{*1}, even if you turned it off the last time you drove the vehicle.

☒ City-Brake Active system

The system may automatically shut off, and the **CTBA** indicator can come on and the message can appear on the multi-information display when:

- The temperature around the laser sensor on the upper part of the windscreen becomes high.
- The area around the laser sensor, which is located in the upper part of the windscreen, is covered with obstacles, such as dirt, ice and frost.
- The bonnet is covered with obstacles such as snow.

Stop your vehicle in a safe place, and

- Use the air conditioning system to cool down the interior if the laser sensor temperature is high.
- Remove any obstacles such as dirt and snow from the windscreen and bonnet.

➤ **Indicators** P. 104

Once the conditions that caused the system to shut off improve, the system comes back on.

Turn off the system when:

- You use a dynamometer or put the wheels on a roller.
- Driving off road or on a mountainous road obstructed with branches and leaves.

*1: Models with the keyless access system have an **ENGINE START/STOP** button instead of an ignition switch.

■ With Little Chance of a Collision

The system may activate even when you are aware of a vehicle ahead of you, or when there is no vehicle ahead. Some examples of this are:

■ When passing

Your vehicle approaches another vehicle ahead of you and you change lanes to pass.

■ At an intersection

Your vehicle approaches or passes another vehicle that is making a left or right turn.

■ Through a low bridge

You drive under a low or narrow bridge.

■ Speed bumps, road work sites, train tracks, roadside objects, etc.

You drive over speed bumps, steel road plates, etc., or your vehicle approaches train tracks or roadside objects, such as a traffic sign and guard rail, on a curve.

■ When parking

Your vehicle approaches a stationary vehicle or wall.

⊠ City-Brake Active system

Take your vehicle to a dealer if you need the laser sensor or area around it to be repaired, or removed, or the area around the laser sensor is strongly impacted.

Do not alter your vehicle's suspension. Changing the vehicle height prevents the system to work properly.

Make sure to use the same size and type of tyre for all four wheels. Use the tyres that are all in about the same condition with adequate tread. If not, the system may operate abnormally.

The system may not work properly if:

- Your vehicle has heavy load in the rear.
- Tyres are over- or underinflated.

About the Laser Equipped in the System

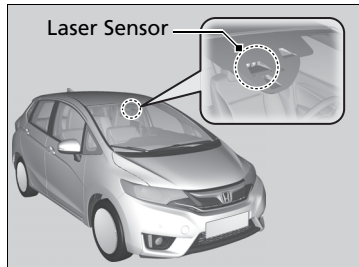

The City-Brake Active system unit, including the laser sensor, is located behind the rearview mirror.

Following lists the classified specifications of the laser used in this system according to the IEC requirements. The same information can be found in the IEC60825-1 standard labels.

Laser classification

Max average power:	45 mW
Pulse duration:	33 ns
Wavelength:	905 nm
Average power angle (horizontal x vertical)	28 x 12

Laser Classification Label



Laser Explanation Label

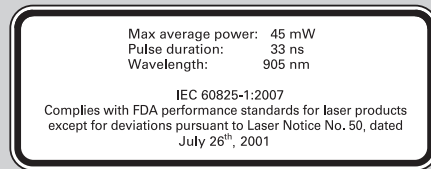

City-Brake Active system

⚠ WARNING

Handling the laser sensor improperly can lead to eye injury.

To avoid eye injury, Keep the following:

- Do not take the sensor apart from the unit.
- Never look at the sensor within a 100 mm distance using an optical device, such as a magnified glass, microscopes, and an object lens.

Emergency Stop Signal

Activates when you brake hard while driving at 60 km/h (37 mph) or above to alert drivers behind you about sudden braking by rapidly flashing hazard warning lights. This may help to alert drivers behind you to take appropriate means to avoid a possible collision with your vehicle.

■ When the system activates:

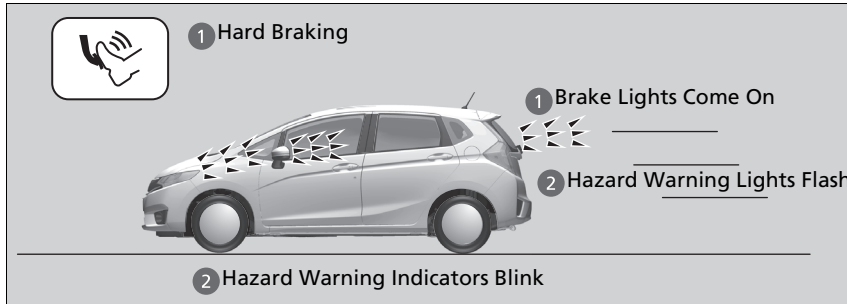

The hazard warning lights stop flashing when:

- You release the brake pedal.
- The ABS is deactivated.
- Your vehicle's decelerating speed becomes moderate.
- You press the hazard warning button.

⚠ Emergency Stop Signal

The emergency stop signal is not a system that can prevent a possible rear-end collision caused by your hard braking. It flashes the hazard warning lights at the time you are braking hard. It is always recommended to avoid hard braking unless it is absolutely necessary.

The emergency stop signal does not activate with the hazard warning button pressed in.

If the ABS stops working for a certain period of the during braking, the emergency stop signal may not activate at all.

When Stopped

1. Depress the brake pedal firmly.
2. Firmly apply the parking brake.

Continuously variable transmission models

3. Move the shift lever from **D** to **P**.

Manual transmission models

3. Move the shift lever to **R** or **1**.
4. Turn off the engine.

Always set the parking brake firmly, in particular if you are parked on an incline.

» Parking Your Vehicle

Do not park your vehicle near flammable objects, such as dry grass, oil, or timber. Heat from the exhaust can cause a fire.

» When Stopped

NOTICE

Continuously variable transmission models

The following can damage the transmission:

- Depressing the accelerator and brake pedals simultaneously.
- Holding the vehicle in place when facing uphill by depressing the accelerator pedal.
- Moving the shift lever into **P** before the vehicle stops completely.

Raise the wiper arms when snow is expected.

Parking Sensor System*

The corner and centre sensors monitor obstacles around your vehicle, and the beeper and multi-information display and audio/information screen* let you know the approximate distance between your vehicle and the obstacle.

■ The sensor location and range

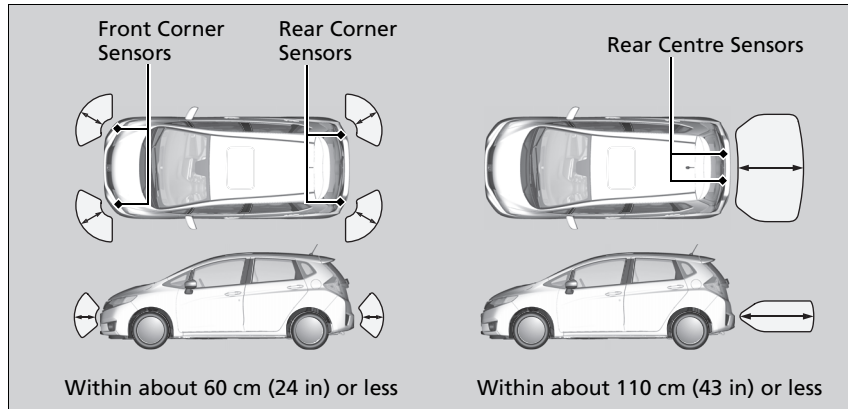

⊠ Parking Sensor System*

Even when the system is on, always confirm if there is no obstacle near your vehicle before parking.

The system may not work properly when:

- The sensors are covered with snow, ice mud or dirt.
- The vehicle is on uneven surface, such as grass, bumps, or a hill.
- The vehicle has been out in hot or cold weather.
- The system is affected by some electric devices that generate ultrasonic wave.
- Driving in bad weather.

The system may not sense:

- Thin or low objects.
- Sonic-absorptive materials, such as snow, cotton, or sponge.
- Objects directly under the bumper.

Do not put any accessories on or around the sensors.

* Not available on all models

■ Parking sensor system on and off

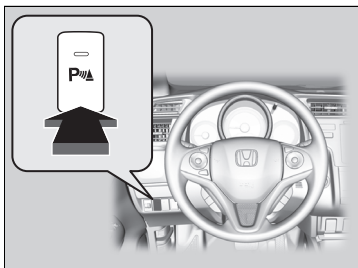

With the ignition switch in ON **[II]***1, press the parking sensor system button to turn on or off the system. The indicator in the button comes on when the system is on.

The front corner sensors start to detect an obstacle when the shift lever is in any position other than **[P]** or **[R]**, and the vehicle speed is less than 8 km/h (5 mph).

The front corner, rear corner and rear centre sensors start to detect an obstacle when the shift lever is in **[R]**, and the vehicle speed is less than 8 km/h (5 mph).

Manual transmission models

You also need to release the parking brake.

▶ Parking sensor system on and off

The parking sensor system is in the previously selected on or off setting each time you start the engine.

*1 : Models with the keyless access system have an **ENGINE START/STOP** button instead of an ignition switch.

■ When the distance between your vehicle and obstacles becomes shorter

Models with multi-view rear camera

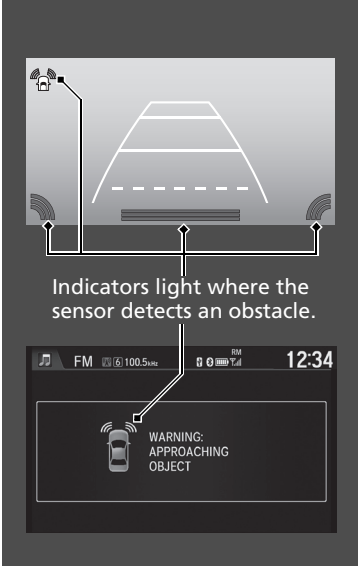
Length of the intermittent beep	Distance between the Bumper and Obstacle		Indicator	Audio/information screen
	Corner Sensors	Centre Sensors		
Moderate	—	Rear: About 110-60 cm (43-24 inches)	Blinks in Yellow*1	 <p>Indicators light where the sensor detects an obstacle.</p> <p>WARNING: APPROACHING OBJECT</p>
Short	About 60-45 cm (24-18 inches)	About 60-45 cm (24-18 inches)	Blinks in Amber	
Very short	About 45-35 cm (18-14 inches)	About 45-35 cm (18-14 inches)		
Continuous	About 35 cm (14 inches) or less	About 35 cm (14 inches) or less	Blinks in Red	

*1: At this stage, only the centre sensors detect obstacles.

Models without multi-view rear camera

Length of the intermittent beep	Distance between the Bumper and Obstacle		Indicator	Multi-information display
	Corner Sensors	Centre Sensors		
Moderate* ¹	—	Rear: About 110-60 cm (43-24 inches)	—	 <p>Indicators: Where the sensor detects an obstacle lights.</p>
Short	About 60-45 cm (24-18 inches)	About 60-45 cm (24-18 inches)	—	
Very short	About 45-35 cm (18-14 inches)	About 45-35 cm (18-14 inches)		
Continuous	About 35 cm (14 inches) or less	About 35 cm (14 inches) or less	—	

*1: At this stage, only the centre sensors detect obstacles.

■ Turning off All Rear Sensors

1. Make sure that the parking sensor system is not activated. Turn the ignition switch to LOCK **[0]***1.
2. Press and hold the parking sensor system button, and turn the ignition switch to ON **[II]***1.
3. Keep pressing the button for ten seconds. Release the button when the indicator in the button flashes.
4. Press the button again. The indicator in the button goes off.
 - ▶ The beeper sounds twice. The rear sensors are now turned off.

To turn the rear sensors on again, follow the above procedure. The beeper sounds three times when the rear sensors come back on.

☒ Turning off All Rear Sensors

When you shift to **[R]**, the indicator in the parking sensor system button blinks as a reminder that the rear sensors have been turned off.

*1: Models with the keyless access system have an **ENGINE START/STOP** button instead of an ignition switch.

* Not available on all models

About Your Multi-View Rear Camera

The audio/information screen can display your vehicle's rear view. The display automatically changes to the rear view when the shift lever is moved to **R**.

Multi-View Rear Camera Display Area

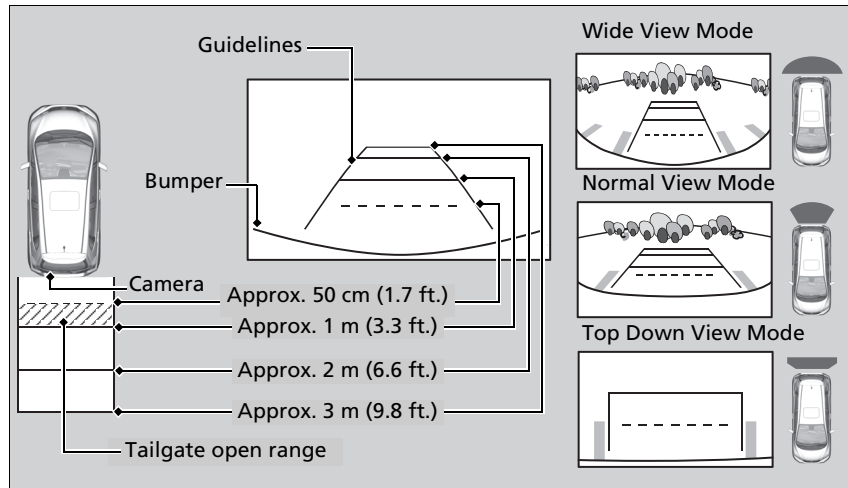

About Your Multi-View Rear Camera

The rear camera view is restricted. You cannot see the corner ends of the bumper or what is underneath the bumper. Its unique lens also makes objects appear closer or farther than they actually are.

Visually confirm that it is safe to drive before backing up. Certain conditions (such as weather, lighting, and high temperatures) may also restrict the rear view. Do not rely on the rearview display which does not give you all information about conditions at the back of your vehicle.

If the camera lens is covered with dirt or moisture, use a soft, moist cloth to keep the lens clean and free of debris.

You can change the **Fixed Guideline** and **Dynamic Guideline** settings.

➤ **Customized Features** P. 316

Fixed Guideline

On: Guidelines appear when you shift into **R**.

Off: Guidelines do not appear.

Dynamic Guideline

On: Guidelines move according to the steering wheel direction.

Off: Guidelines do not move.

You can view three different camera angles on the rearview display.

Touch the appropriate icon to switch the angle.



: Wide view



: Normal view



: Top down view

If the last used viewing mode is Wide or Normal, the same mode is selected the next time you shift into **[R]**. If Top View is last used before you turned off the engine, Wide mode is selected next time you set the power mode to ON and shift to **[R]**.

You can also change the rear camera setting by selecting **MENU** on the rear camera screen. When you select **MENU** and select **Display**, the following items are available in additional:

- **Display** tab: Adjusts **Brightness**, **Contrast**, and **Black Level** of the rear camera screen.
- **Colour** tab: Adjusts **Colour** and **Tint** of the rear camera screen.

Fuel Information

■ Fuel recommendation

Unleaded premium petrol, research octane number 95 or higher

Your vehicle is designed to operate on premium unleaded petrol with a research octane of 95 or higher. If this octane grade is unavailable, regular unleaded petrol with a research octane of 91 or higher may be used temporarily. Use of regular unleaded petrol can cause metallic knocking noises in the engine and will result in decreased engine performance. The long-term use of regular-grade petrol can lead to engine damage.

■ Fuel tank capacity: 40 litres (8.8 Imp gal)

» Fuel Information

NOTICE

Use of petrol that contains lead presents the following risks:

- Damage to the exhaust system including the catalytic converter
- Damage to the engine and fuel system
- Detrimental effects on the engine and other systems

Oxygenated Fuels

Oxygenated fuels are blended with petrol and ethanol or ether compound. Your vehicle is also designed to operate on oxygenated fuels containing up to 10% ethanol by volume and up to 22% ETBE by volume, based on the EN 228 standards. For more information, ask your dealer.

How to Refuel

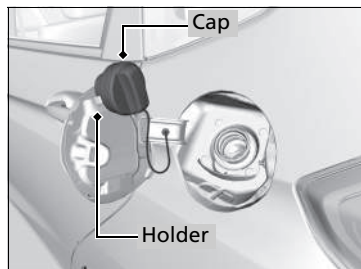
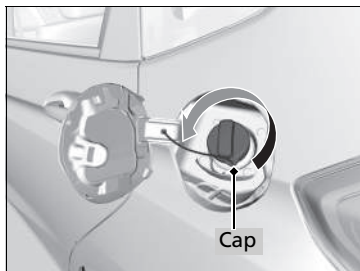
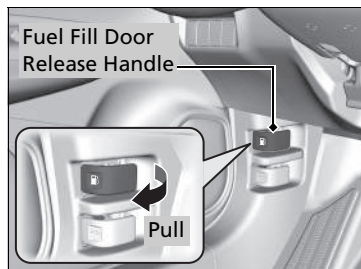

1. Stop your vehicle with the service station pump on the left side of the vehicle in the rear.
2. Turn off the engine.
3. Pull on the fuel fill door release handle under the dashboard at the driver's side.
 - ▶ The fuel fill door opens.
4. Remove the fuel fill cap slowly. If you hear a release of air, wait until this stops, then turn the knob slowly to open the fuel fill cap.
5. Place the fuel fill cap in the holder.
6. Insert the filler nozzle fully.
 - ▶ When the tank is full, the fuel nozzle will click off automatically. This leaves space in the fuel tank in case the fuel expands with a change in the temperature.
7. After filling, replace the fuel fill cap, tightening it until you hear it click at least once.
 - ▶ Shut the fuel fill door by hand.

How to Refuel

⚠ WARNING

Petrol is highly flammable and explosive. You can be burned or seriously injured when handling fuel.

- Stop the engine, and keep heat, sparks, and flame away.
- Handle fuel only outdoors.
- Wipe up spills immediately.

The filler nozzle automatically stops to leave space in the fuel tank so that fuel does not overflow as a result of changes in air temperature.

Do not continue to add fuel after the nozzle has automatically stopped. Additional fuel can exceed the full tank capacity.

Improving Fuel Economy

Fuel economy depends on several conditions, including driving conditions, your driving habits, the condition of your vehicle, and loading. Depending on these and other conditions, you may or may not achieve the rated fuel economy of this vehicle.

Maintenance and Fuel Economy

You can optimize your fuel economy with proper maintenance of your vehicle. Always maintain your vehicle according to the service reminder symbols displayed on the multi-information display. On vehicles without service reminder system, follow the maintenance schedule in the Service Book that came with your vehicle. On vehicles without Service Book, follow the maintenance schedule in this owners manual. If necessary, consult your warranty booklet.

Maintenance Schedule* P. 478

- Use engine oil with the viscosity recommended by the ACEA or API Certification Seal.
- Maintain the specified tyre pressure.
- Do not load the vehicle with excess luggage.
- Keep your vehicle clean. A buildup of snow or mud on your vehicle's underside adds weight and increases wind resistance.

Improving Fuel Economy

Direct calculation is the recommended method to determine actual fuel consumed while driving.

100	×	Litres of fuel	÷	Kilometres driven	=	L per 100 km
Miles driven	÷	Gallons of fuel	=	Miles per Gallon		

Accessories

When installing accessories, check the following:

- Do not install accessories on the windshield. They can obstruct your view and delay your reaction to driving conditions.
- Do not install any accessories over areas marked SRS Airbag, on the sides or backs of the front seats, on front or side pillars, or near the side windows. Accessories installed in these areas may interfere with proper operation of the vehicle's airbags or may be propelled into you or another occupant if the airbags deploy.
- Be sure electronic accessories do not overload electrical circuits or interfere with proper operation of your vehicle.
 - ▣ **Fuses** P. 565
- Before installing any electronic accessory, have the installer contact a dealer for assistance. If possible, have a dealer inspect the final installation.

Modifications

Do not modify your vehicle or use non-Honda components that can affect its handling, stability, and reliability.

Overall vehicle performance can be affected. Always make sure all equipment is properly installed and maintained, and that it meets your country's and local regulations.

Accessories and Modifications

WARNING

Improper accessories or modifications can affect your vehicle's handling, stability, and performance, and cause a crash in which you can be seriously hurt or killed.

Follow all instructions in this owner's manual regarding accessories and modifications.

When properly installed, mobile phones, alarms, two-way radios, radio antennas, and low-powered audio systems should not interfere with your vehicle's computer controlled systems, such as your airbags and anti-lock brakes.

Honda Genuine accessories are recommended to ensure proper operation on your vehicle.

Maintenance

This chapter discusses basic maintenance.



Before Performing Maintenance

Inspection and Maintenance	470
Safety When Performing Maintenance.....	471
Parts and Fluids Used in Maintenance	
Service	472
Service Reminder System*	473
Maintenance Schedule*	478
Maintenance Record (On vehicles without	
Service Book)	481
Maintenance Under the Bonnet	
Maintenance Items Under the Bonnet.....	482
Opening the Bonnet	483
Recommended Engine Oil	484

Oil Check.....	486
Adding Engine Oil.....	487
Engine Coolant	488
Transmission Fluid.....	490
Brake Fluid.....	491
Refilling Window Washer Fluid.....	492
Fuel Filter	492
Replacing Light Bulbs	493
Checking and Maintaining Wiper	
Blades	504
Checking and Maintaining Tyres	
Checking Tyres	508
Wear Indicators.....	510

Tyre Service Life	510
Tyre and Wheel Replacement.....	511
Tyre Rotation	512
Snow Traction Devices	513
Battery	515
Remote Transmitter Care	
Replacing the Button Battery	520
Heating and Cooling System*/Climate Control	
System* Maintenance	522
Cleaning	
Interior Care	525
Exterior Care.....	527

* Not available on all models

Inspection and Maintenance

For your safety, perform all listed inspections and maintenance to keep your vehicle in good condition. If you become aware of any abnormality (noise, smell, insufficient brake fluid, oil residue on the ground, etc.), have your vehicle inspected by a dealer. Refer to the Service Book that came with your vehicle/maintenance schedule in this owner's manual for detailed maintenance and inspection information.

➤ **Maintenance Schedule*** P. 478

Types of Inspection and Maintenance

■ Daily inspections

Perform inspections before long distance trips, when washing the vehicle, or when refueling.

■ Periodic inspections

- Check the brake fluid level monthly.
 - **Brake Fluid** P. 491
- Check the tyre pressure monthly. Examine the tread for wear and foreign objects.
 - **Checking and Maintaining Tyres** P. 508
- Check the operation of the exterior lights monthly.
 - **Replacing Light Bulbs** P. 493
- Check the condition of the wiper blades at least every six months.
 - **Checking and Maintaining Wiper Blades** P. 504

Safety When Performing Maintenance

Some of the most important safety precautions are given here. However, we cannot warn you of every conceivable hazard that can arise in performing maintenance. Only you can decide whether or not you should perform a given task.

Maintenance Safety

- To reduce the possibility of fire or explosion, keep cigarettes, sparks, and flames away from the battery and all fuel related parts.
- Never leave rags, towels, or other flammable objects under the bonnet.
 - ▶ Heat from the engine and exhaust can ignite them causing a fire.
- To clean parts, use a commercially available degreaser or parts cleaner, not petrol.
- Wear eye protection and protective clothing when working with the battery or compressed air.
- Engine exhaust contains carbon monoxide, which is poisonous and can kill you.
 - ▶ Only operate the engine if there is sufficient ventilation.

Vehicle Safety

- The vehicle must be in a stationary condition.
 - ▶ Make sure your vehicle is parked on level ground, the parking brake is set, and the engine is off.
- Be aware that hot parts can burn you.
 - ▶ Make sure to let the engine and exhaust system cool thoroughly before touching vehicle parts.
- Be aware that moving parts can injure you.
 - ▶ Do not start the engine unless instructed, and keep your hands and limbs away from moving parts.
 - ▶ Do not open the bonnet while the Auto Idle Stop function is activated.

⚠ Safety When Performing Maintenance

⚠ WARNING

Improperly maintaining this vehicle or failing to correct a problem before driving can cause a crash in which you can be seriously hurt or killed.

Always follow the inspection and maintenance recommendations and schedules in this owner's manual/Service Book.

⚠ WARNING

Failure to properly follow maintenance instructions and precautions can cause you to be seriously hurt or killed.

Always follow the procedures and precautions in this owner's manual.

Parts and Fluids Used in Maintenance Service

The use of Honda genuine parts and fluids is recommended when maintaining and servicing your vehicle. Honda genuine parts are manufactured according to the same high quality standards used in Honda vehicles.

About Your Maintenance Service

If the service reminder system is available in your vehicle, you are informed by the multi-information display when your vehicle's maintenance services are due. Refer to Service Book that came with your vehicle for an explanation of the service item codes that appear on the display.

📄 **Service Reminder System*** P. 473

If the service reminder system is not available, follow the maintenance schedules in the Service Book that came with your vehicle.

If your vehicle is without the Service Book, follow the maintenance schedule in this owner's manual.

📄 **Maintenance Schedule*** P. 478

▶▶ About Your Maintenance Service

Models with service reminder system

If you are planning to take your vehicle outside the service reminder system applied countries, consult a dealer for how to record your service reminder information and schedule your maintenance service under the conditions of that country.

Service Reminder System*

Provides information of which service items are to be performed. Service items are represented by a code and icon. The system tells you when to take your vehicle to a dealer by days remaining.

When the next maintenance service timing is near, coming or passed, a warning icon will also appear on the multi-information display every time you turn the ignition switch to ON *1.

Service Reminder System*

You can choose to have a corresponding warning message displayed with the warning icon on the multi-information display.



The maintenance schedule may not display correct information if you disconnect or remove the battery for an extended period. If this occurs, see a dealer.

*1: Models with the keyless access system have an **ENGINE START/STOP** button instead of an ignition switch.

* Not available on all models

Continued

■ Displaying the Service Reminder Information

1. Turn the ignition switch to ON *1.
2. Press the / (information) button repeatedly until the maintenance item(s) appears on the multi-information display.

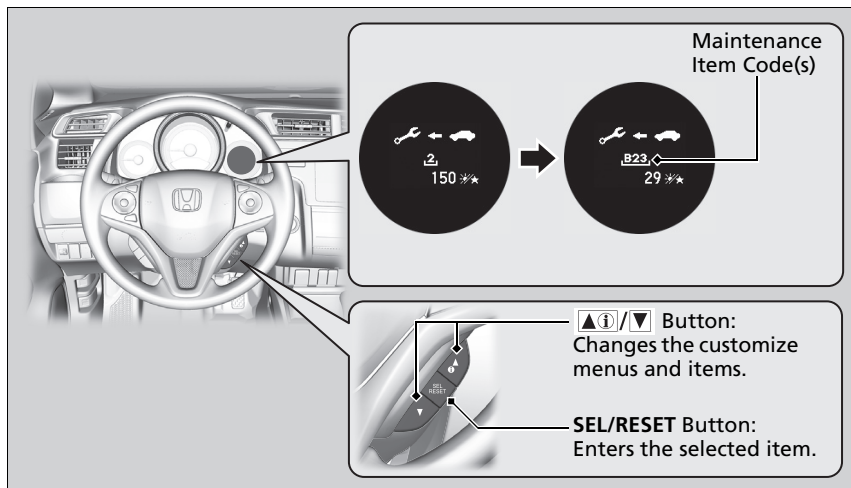

The system message indicator (ⓘ) comes on along with the service reminder information.





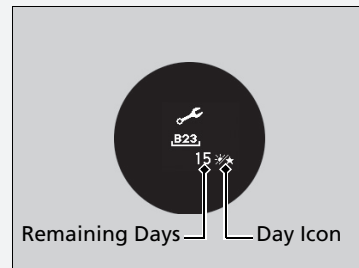

*1 : Models with the keyless access system have an **ENGINE START/STOP** button instead of an ignition switch.

▶▶ Displaying the Service Reminder Information

Based on engine operating conditions and engine oil conditions, the system calculates the remaining days before the next service is to be performed.



Warning Icons and Service Reminder Information on the Multi-Information Display

Warning Icon (Amber)	Service Reminder Information	Explanation	Information
<p>SERVICE DUE SOON</p> 		<p>One or more of the service items are required in less than 30 days. The remaining days are estimated based on your driving conditions.</p>	<p>The remaining days will be counted down per day.</p>
<p>SERVICE DUE NOW</p> 		<p>One or more of the service items are required in less than 10 days. The remaining days are estimated based on your driving conditions.</p>	<p>Have the indicated service performed as soon as possible.</p>
<p>SERVICE OVER DUE</p> 		<p>The indicated maintenance service is still not done after the remaining days reach 0.</p>	<p>Your vehicle has passed the service required point. Immediately have the service performed and make sure to reset the service reminder system.</p>

■ Service Reminder Items

Service items displayed on the multi-information display are in code and icon. For an explanation of the service reminder codes and icons, refer to the Service Book that came with your vehicle.

■ Availability of the Service Reminder System

Even if the service reminder information appears on the multi-information display while pressing the  (information) button, this system is not available in some countries. Refer to Service Book that came with your vehicle, or ask a dealer if you can use the service reminder system.

⌘ Availability of the Service Reminder System

If you are planning to take your vehicle outside the service reminder system applied countries, consult a dealer on how to record your service reminder information and schedule your maintenance service under the conditions of that country.

Resetting the Display

Reset the service reminder information display if you have performed the maintenance service.

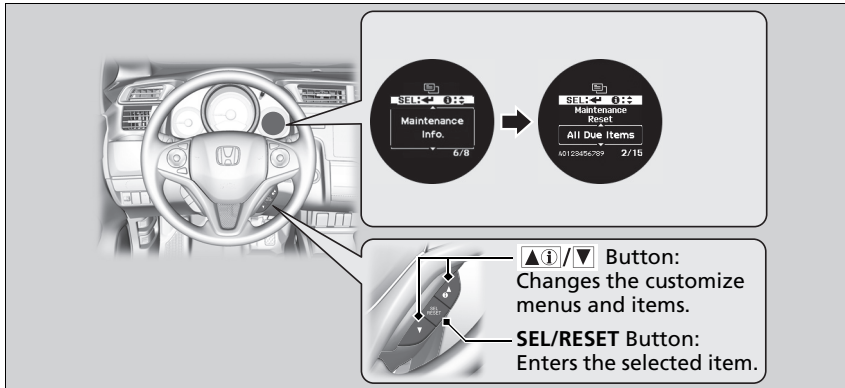

1. Turn the ignition switch to ON *1.
2. Press the until (customize settings) appears on the display, then press the **SEL/RESET** button.
3. Press the until **Maintenance Info.** appears on the display, then press the **SEL/RESET** button.
4. Press the and select the reset information on the display, then press the **SEL/RESET** button.
 - ▶ The service code will disappear.

To cancel the service reminder information reset mode, select **Cancel**, then press the **SEL/RESET** button.

*1: Models with the keyless access system have an **ENGINE START/STOP** button instead of an ignition switch.

Resetting the Display

NOTICE

Failure to reset the service reminder information after a maintenance service results in the system showing incorrect maintenance intervals, which can lead to serious mechanical problems.

The dealer will reset the service reminder information display after completing the required maintenance service. If someone other than a dealer performs maintenance service, reset the service reminder information display yourself.

Maintenance Schedule*

If your vehicle comes with the Service Book, the maintenance schedule for your vehicle is available in the book. For vehicles without the Service Book, refer to the following maintenance schedule.

The maintenance schedule outlines the minimum required maintenance that you should perform to ensure the troublefree operation of your vehicle. Due to regional and climatic differences, some additional servicing may be required. Please consult your warranty booklet for a more detailed description.

Maintenance work should be performed by properly trained and equipped technicians. Your authorised dealer meets all of these requirements.

Models without Service Book

Service at the indicated distance or time - whichever comes first.	km x 1,000	20	40	60	80	100	120	140	160	180	200
	miles x 1,000	12.5	25.0	37.5	50.0	62.5	75.0	87.5	100.0	112.5	125.0
	months	12	24	36	48	60	72	84	96	108	120
Replace engine oil* ¹	Normal	Every 10,000 km (6,250 miles) or 1 year									
	Severe* ³	Every 5,000 km (3,125 miles) or 6 months									
Replace engine oil filter* ¹	Normal	Every 20,000 km (12,000 miles) or 2 years									
	Severe* ³	Every 10,000 km (6,250 miles) or 1 year									
Replace air cleaner element* ¹	Every 30,000 km (18,750 miles)										
Inspect valve clearance	Every 120,000 km (75,000 miles)										
Replace fuel filter* ²					•				•		
Replace spark plugs	Every 100,000 km (62,500 miles)										
Inspect drive belts		•		•		•		•		•	
Inspect idle speed						•					

*1: Only severe schedule is required in some countries: refer to the local warranty booklet that came with your vehicle.

*2: Refer to page 492 for replacement information under severe driving conditions.

*3: Refer to page 480 for replacement information under severe conditions.

Service at the indicated distance or time - whichever comes first.	km x 1,000	20	40	60	80	100	120	140	160	180	200
	miles x 1,000	12.5	25.0	37.5	50.0	62.5	75.0	87.5	100.0	112.5	125.0
	months	12	24	36	48	60	72	84	96	108	120
Replace engine coolant	At 200,000 km (120,000 miles) or 10 years, thereafter every 100,000 km (60,000 miles) or 5 years										
Replace transmission fluid	MT Normal	Every 120,000 km (72,000 miles) or 6 years									
	Severe* ¹			•			•			•	
	CVT		•		•		•		•		•
Inspect front and rear brakes	Every 10,000 km (6,250 miles) or 6 months										
Replace brake fluid	Every 3 years										
Check parking brake adjustment	•	•		•		•		•		•	
Replace dust and pollen filter	•	•	•	•	•	•	•	•	•	•	•
Check expiry date for TRK bottle*	Every year										
Rotate tyres (Check tyre inflation and condition at least once per month)	Every 10,000 km (6,250 miles)										
Visually inspect the following items:											
Tie rod ends, steering gear box, and boots Suspension components Driveshaft boots	Every 10,000 km (6,250 miles) or 6 months										
Brake hoses and lines (including ABS) All fluid levels and condition of fluid Exhaust system Fuel lines and connections	•	•	•	•	•	•	•	•	•	•	•

*1: Refer to page 480 for replacement information under severe conditions.

* Not available on all models

If you drive your vehicle under severe conditions, you must have the following items served to the maintenance schedule indicated as Severe.

Items	Condition
Engine oil and filter	A, B, C, D and E
Transmission fluid	B and D

⌘ Maintenance Schedule*

- The condition is considered as severe when you drive:
- A. less than 8 km (5 miles), or less than 16 km (10 miles) in freezing temperatures per trip.
 - B. in extremely hot temperature above 35°C.
 - C. with extensive idling or long periods of stop-and-go.
 - D. towing trailer, loaded roof rack, or in mountains.
 - E. on muddy, dusty or de-iced roads.

Maintenance Record (On vehicles without Service Book)

Have your servicing dealer record all required maintenance below. Keep receipts for all work done on your vehicle.

Km (Mi.) or Month	Date	Sign or Stamp
20,000 km 12,500 Mi. (or 12 Mo.)		
40,000 km 25,000 Mi. (or 24 Mo.)		
60,000 km 37,500 Mi. (or 36 Mo.)		
80,000 km 50,000 Mi. (or 48 Mo.)		
100,000 km 62,500 Mi. (or 60 Mo.)		
120,000 km 75,000 Mi. (or 72 Mo.)		
140,000 km 87,500 Mi. (or 84 Mo.)		
160,000 km 100,000 Mi. (or 96 Mo.)		
180,000 km 112,500 Mi. (or 108 Mo.)		
200,000 km 125,000 Mi. (or 120 Mo.)		

Maintenance Items Under the Bonnet

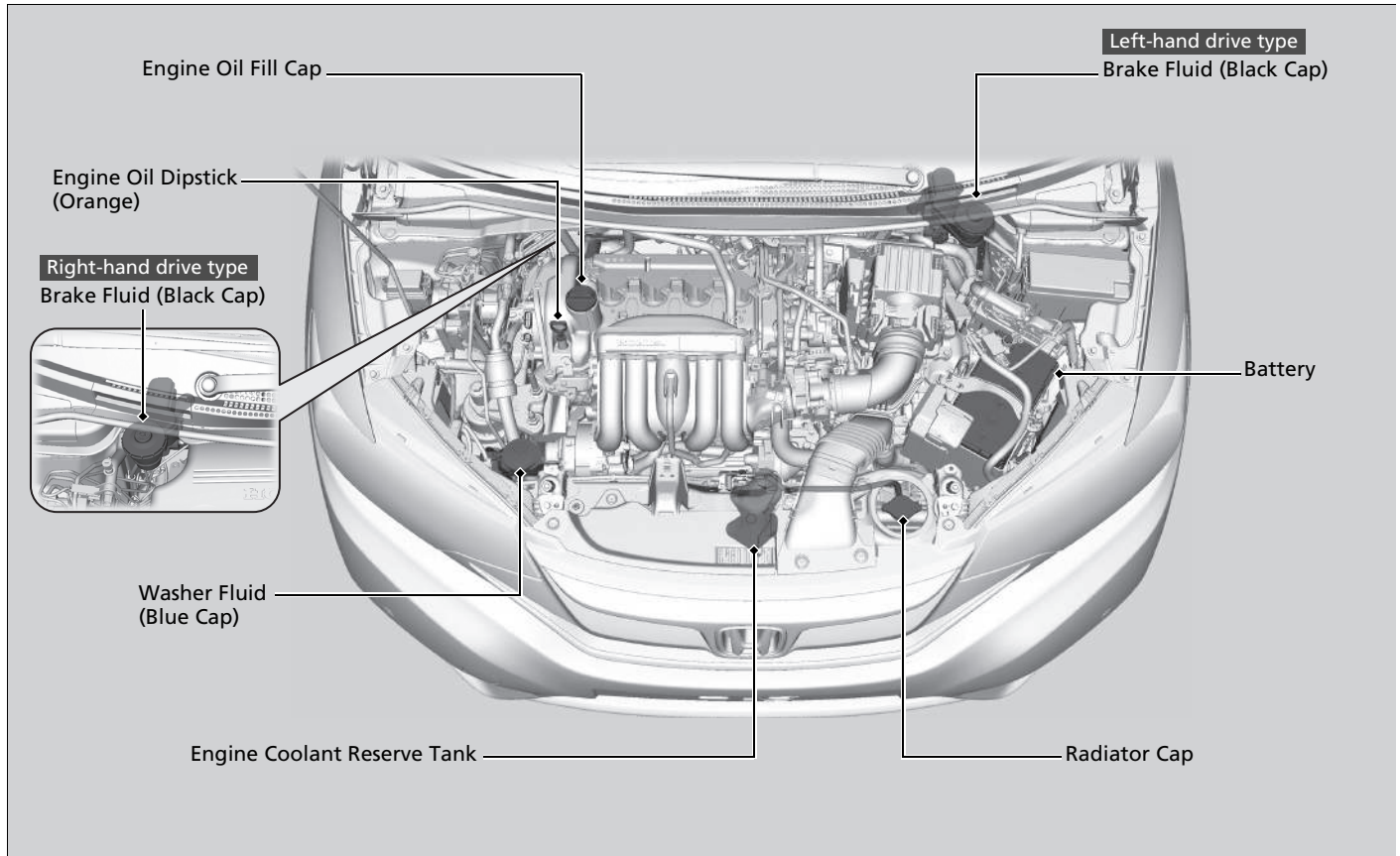

Opening the Bonnet

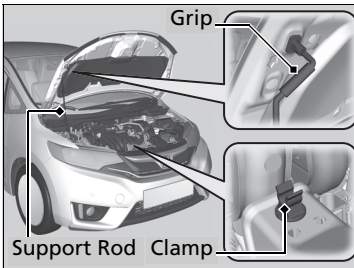
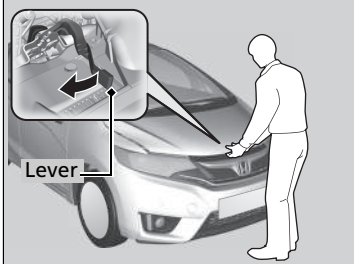
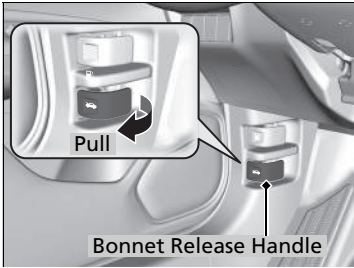

1. Park the vehicle on a level surface, and set the parking brake.
2. Pull the bonnet release handle under the dashboard at the driver's side.
 - The bonnet will pop up slightly.
3. Pull up the bonnet latch lever in the centre of the bonnet to release the lock mechanism, and open the bonnet.

4. Remove the support rod from the clamp using the grip. Mount the support rod in the bonnet.

When closing, remove the support rod, and stow it in the clamp, then gently lower the bonnet. Remove your hand at a height of approximately 30 cm (12 inches) and let the bonnet close.

Opening the Bonnet

NOTICE

Do not open the bonnet when the wiper arms are raised. The bonnet will strike the wipers, and may damage either the bonnet or the wipers.

When closing the bonnet, check that the bonnet is securely latched.

If the bonnet latch lever moves stiffly, or if you can open the bonnet without lifting the lever, the latch mechanism should be cleaned and lubricated.

Do not open the bonnet while the Auto Idle Stop function is activated.

Recommended Engine Oil

Oil is a major contributor to your engine's performance and longevity. If you drive the vehicle with insufficient or deteriorated oil, the engine may fail or be damaged.

European models with service reminder

- **Honda ENG Oil #1.0**
- **Honda Green Oil**
- **ACEA A3/B3**
- **ACEA A5/B5**

European models without service reminder

- **Honda ENG Oil #1.0**
- **Honda Green Oil**
- **ACEA A1/B1**
- **ACEA A3/B3**
- **ACEA A5/B5**

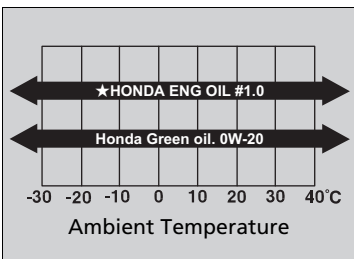

Use a commercial engine oil of suitable viscosity for the ambient temperature as shown.

Honda ENG Oil #1.0 oil is formulated to improve fuel economy.

If Honda ENG Oil #1.0, Honda Green Oil, or 0W-20 is not available, use 5W-30 or 0W-30.

Recommended Engine Oil

Engine Oil Additives

Your vehicle does not require oil additives. In fact, they may adversely affect the engine performance and durability.

ACEA viscosity oil is available for European models only.

Except European models

- **Genuine Honda Motor Oil**
- **API service SM or higher grade fuel-efficient oil**

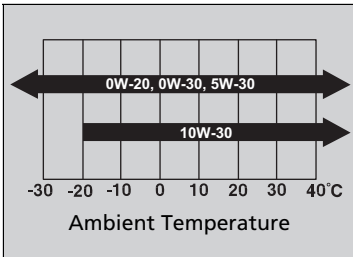

Use a Genuine Honda Motor oil or another commercial engine oil of suitable SAE viscosity for the ambient temperature as shown.

0W-20 oil is formulated to improve fuel economy.

Oil Check

We recommend that you check the engine oil level every time you refuel.

Park the vehicle on level ground.

Wait approximately three minutes after turning the engine off before you check the oil.

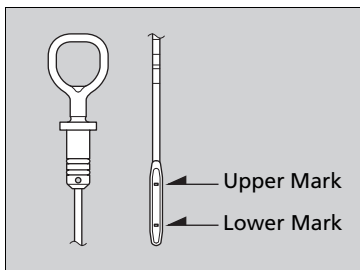
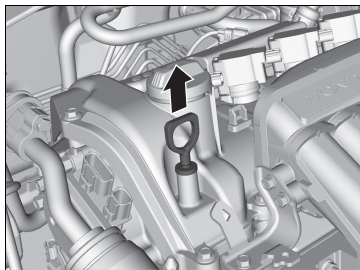

1. Remove the dipstick (orange).
2. Wipe the dipstick with a clean cloth or paper towel.
3. Insert the dipstick back all the way into its hole.
4. Remove the dipstick again, and check the level. It should be between the upper and lower marks. Add oil if necessary.

Oil Check

If the oil level is near or below the lower mark, slowly add oil being careful not to overfill.

The amount of oil consumed depends on how the vehicle is driven and the climatic and road conditions encountered. The rate of oil consumption can be up to 1 litre per 1,000 km/625 miles.

Consumption is likely to be higher when the engine is new.

Adding Engine Oil

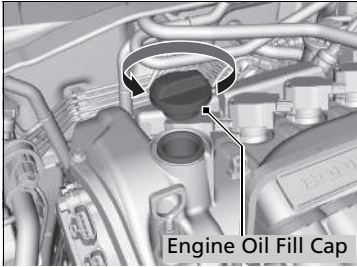

1. Unscrew and remove the engine oil fill cap.
2. Add oil slowly.
3. Reinstall the engine oil fill cap, and tighten it securely.
4. Wait for three minutes and recheck the engine oil dipstick.

Adding Engine Oil

NOTICE

Do not fill the engine oil above the upper limit mark. Overfilling the engine oil can result in leaks and engine damage.

If any oil spills, wipe it up immediately. Spilled oil may damage the engine compartment components.

Engine Coolant

Specified coolant: Honda All Season Antifreeze/Coolant Type 2

This coolant is premixed with 50% antifreeze and 50% water. Do not add any straight antifreeze or water.

We recommend you check the engine coolant level every time you refuel. Check the reserve tank first. If it is completely empty, also check the coolant level in the radiator. Add the engine coolant accordingly.

Reserve Tank

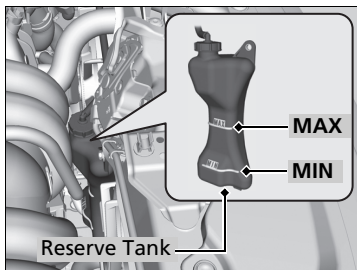

1. Check the amount of coolant in the reserve tank.

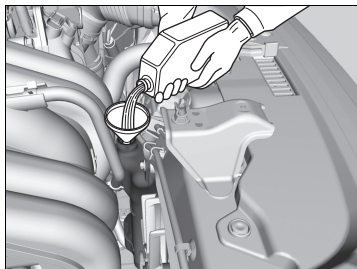

2. If the coolant level is below the **MIN** mark, add the specified coolant until it reaches the **MAX** mark.

3. Inspect the cooling system for leaks.

Engine Coolant

If Honda antifreeze/coolant is not available, you may use another major brand non-silicate coolant as a temporary replacement. Check that it is a high quality coolant recommended for aluminium engines. Continued use of any non-Honda coolant can result in corrosion, causing the cooling system to malfunction or fail. Have the cooling system flushed and refilled with Honda antifreeze/coolant as soon as possible.

Do not add rust inhibitors or other additives to your vehicle's cooling system. They may not be compatible with the coolant or with the engine components.

Radiator

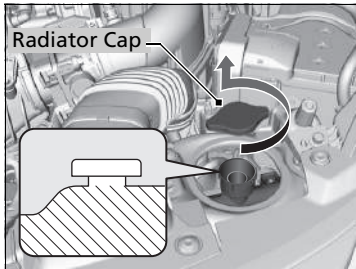

1. **Make sure the engine and radiator are cool.**
2. Turn the radiator cap anticlockwise and allow any pressure in the cooling system to release. Do not push the cap down when turning.
3. Push down and turn the radiator cap anticlockwise to remove it.
4. The coolant level should be up to the base of the filler neck. Add coolant if it is low.
5. Put the radiator cap back on, and tighten it fully.
6. Pour coolant into the reserve tank until it reaches the **MAX** mark. Put the cap back on the reserve tank.

⌘ Radiator

⚠ WARNING

Removing the radiator cap while the engine is hot can cause the coolant to spray out, seriously scalding you.

Always let the engine and radiator cool down before removing the radiator cap.

NOTICE

Pour the fluid slowly and carefully so you do not spill any. Clean up any spills immediately; they can damage components in the engine compartment.

Transmission Fluid

Continuously variable transmission models

Continuously Variable Transmission (CVT) Fluid

Specified fluid: Honda HCF-2 Transmission Fluid

Have a dealer check the fluid level and replace if necessary. Follow your vehicle's maintenance service timing of when to change continuously variable transmission (CVT) fluid.

- **Service Reminder System*** P. 473
- **Maintenance Schedule*** P. 478

Manual transmission models

Manual Transmission Fluid

Specified fluid: Honda Manual Transmission Fluid (MTF)

Have a dealer check the fluid level and replace if necessary. Follow your vehicle's maintenance service timing of when to change manual transmission fluid.

- **Service Reminder System*** P. 473
- **Maintenance Schedule*** P. 478

Continuously Variable Transmission (CVT) Fluid

NOTICE

Do not mix Honda HCF-2 transmission fluid with other transmission fluids.

Using a transmission fluid other than Honda HCF-2 transmission fluid may adversely affect the operation and durability of your vehicle's transmission, and damage the transmission.

Any damage caused by using a transmission fluid that is not equivalent to Honda HCF-2 transmission fluid is not covered by Honda's new vehicle warranty.

Manual Transmission Fluid

If Honda MTF is not available, you may use the API certificated SAE 0W-20 or 5W-20 viscosity motor oil as a temporary measure.

Replace with MTF as soon as possible. Motor oil does not contain the proper additives for the transmission and continued use can cause decreased shifting performance and lead to transmission damage.

Brake Fluid

Specified fluid: Brake Fluid with DOT 3 or DOT 4

■ Checking the Brake Fluid

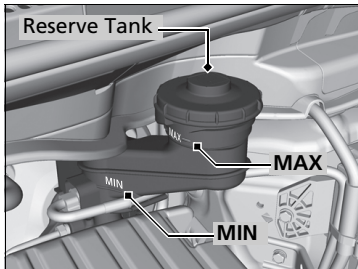

The fluid level should be between the **MIN** and **MAX** marks on the side of the reserve tank.

■ Manual transmission models

The brake fluid reservoir is also used for your vehicle's clutch fluid. As long as you keep the brake fluid level as instructed above, there is no need for checking the clutch fluid level.

▣ Brake Fluid

NOTICE

Brake fluid marked DOT 5 is not compatible with your vehicle's braking system and can cause extensive damage.

We recommend using the specified brake fluid. If the specified brake fluid is not available, you should use only DOT 3 or DOT 4 fluid from a sealed container as a temporary replacement.

If the brake fluid level is at or below the **MIN** mark, have a dealer inspect for leaks or worn brake pads as soon as possible.

Refilling Window Washer Fluid

Check the amount of window washer fluid by looking at the reservoir.

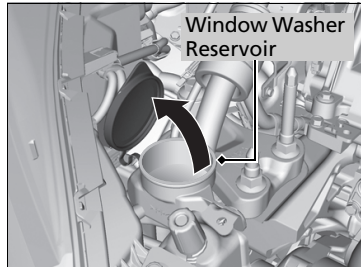

If the level is low, fill the washer reservoir.

Pour the washer fluid carefully. Do not overflow the reservoir.

►► Refilling Window Washer Fluid

NOTICE

Do not use engine antifreeze or a vinegar/water solution in the windscreen washer reservoir. Antifreeze can damage your vehicle's paint. A vinegar/water solution can damage the windscreen washer pump.

Fuel Filter

Replace fuel filter according to the time and distance recommendations in the maintenance schedule.

Models without Service Book

It is recommended to replace the fuel filter every 40,000 km (25,000 miles), or two years, if you suspect the fuel you are using is contaminated. In a dusty environment, the filter may become clogged sooner.

All models

Have a qualified technician change the fuel filter. Fuel in the system can spray out and create a hazard if all fuel line connections are not handled correctly.

Replacing Light Bulbs

Headlight Bulbs

When replacing, use the following bulbs.

High/Low beam headlight: 60/55 W (H4/HB2, H4* for halogen bulb type)

High/Low Beam Headlight

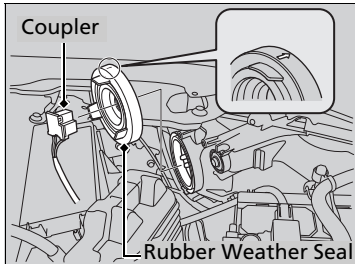

1. Remove the coupler.
2. Remove the rubber weather seal.

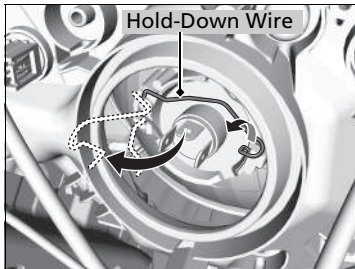

3. Remove the hold-down wire, then remove the bulb.
4. Insert a new bulb.

Headlight Bulbs

NOTICE

Halogen bulbs get very hot when lit.

Oil, perspiration, or a scratch on the glass can cause the bulb to overheat and shatter.

The headlight aim is set by the factory, and does not need to be adjusted. However, if you regularly carry heavy items in the luggage area or tow a trailer, have the aiming readjusted at a dealer or by a qualified technician.

When replacing a halogen bulb, handle it by its base, and protect the glass from contact with your skin or hard objects. If you touch the glass, clean it with denatured alcohol and a clean cloth.

* Not available on all models

Continued

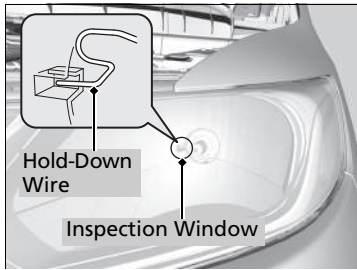

5. Reinstall the hold-down wire. Hook the end of the wire on the knob in the slot.
 - You can see if the hold-down wire is in the right place from the inspection window.
6. Reinstall the rubber weather seal.
7. Insert the coupler into the connector of the bulb.

Front Fog Light Bulbs*

When replacing, use the following bulbs.

Front Fog Light: 35 W (H8 LL for halogen bulb type)

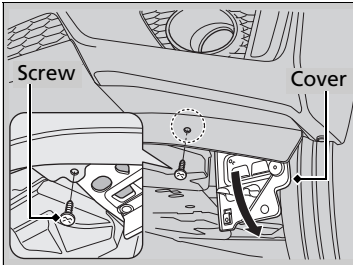

1. Loosen the screw using a Phillips-head screwdriver.
2. Remove the screw, then push up the under cover.

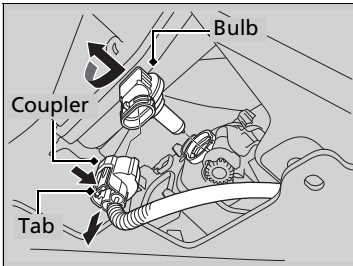

3. Push the tab to remove the coupler.
4. Rotate the old bulb to the left to remove.
5. Insert a new bulb into the fog light assembly and turn it to the right.
6. Insert the coupler into the connector of the bulb.

Front Fog Light Bulbs*

NOTICE

Halogen bulbs get very hot when lit. Oil, perspiration, or a scratch on the glass can cause the bulb to overheat and shatter.

When replacing a halogen bulb, handle it by its plastic case, and protect the glass from contact with your skin or hard objects. If you touch the glass, clean it with denatured alcohol and a clean cloth.

* Not available on all models

Front Turn Signal Light Bulbs

When replacing, use the following bulbs.

Front Turn Signal Light: 21 W (Amber)

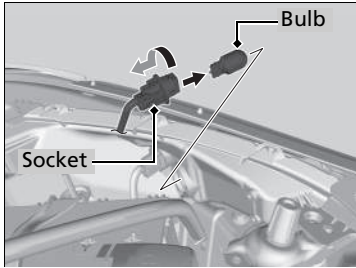

1. Turn the socket to the left and remove it.
2. Pull the bulb straight out of its holder.
3. Insert a new bulb.

Position Light Bulbs

When replacing, use the following bulbs.

Position Light: 5 W

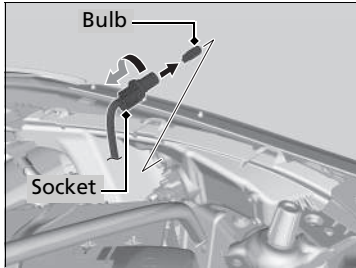

1. Turn the socket to the left and remove it, then remove the old bulb.
2. Insert a new bulb.

Side Turn Signal Light Bulbs

Door mirrors have side turn signal lights. Have an authorized Honda dealer inspect and replace the light bulbs.

Daytime Running Light Bulbs

Daytime running light bulbs are the LED type. Have an authorized Honda dealer inspect and replace the light assembly.

Back-Up Light, Rear Turn Signal Light and Rear Fog Light Bulbs

When replacing, use the following bulbs.

Back-Up Light: 16 W
Rear Turn Signal Light: 21 W (Amber)
Rear Fog Light: 21 W

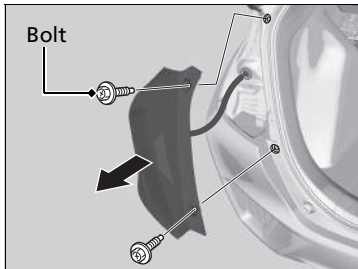

1. Use a Phillips-head screwdriver to remove the bolts.
2. Pull the light assembly out of the rear pillar.

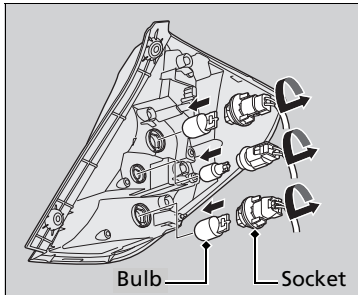

3. Turn the socket to the left and remove it. Remove the old bulb.
4. Insert a new bulb.
5. Slide the light assembly onto the guide on the body.

Brake/Taillight Bulbs

Brake/taillight bulbs are the LED type. Have an authorized Honda dealer inspect and replace the light assembly.

Rear Licence Plate Light Bulbs

When replacing, use the following bulbs.

Rear Licence Plate Light: 5 W

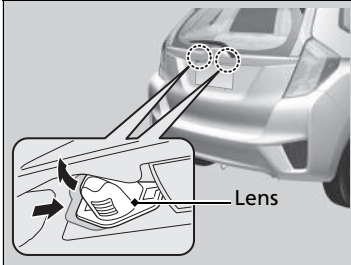

1. Push the lens on the left and pull out the lens and the socket attached to it.

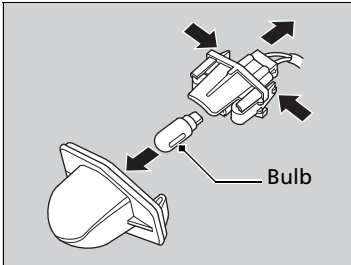

2. Remove the licence plate light assembly by squeezing the tabs on both sides of the socket.
3. Remove the old bulb and insert a new bulb.

High-Mount Brake Light Bulb

High-mount brake light bulbs are LED type. Have an authorized Honda dealer inspect and replace the light assembly.

Other Light Bulbs

■ Ceiling Light Bulb

When replacing, use the following bulb.

Ceiling Light: 8 W



1. Pry on the edge of the cover using a flat-tip screwdriver to remove the cover.
► Wrap the flat-tip screwdriver with a cloth to prevent scratches.

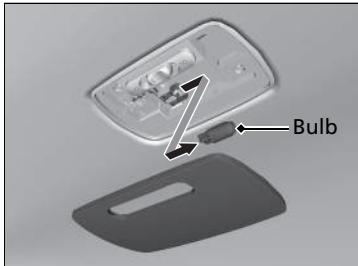

2. Remove the old bulb and insert a new bulb.

■ Map Light Bulbs

Models with display audio system

When replacing, use the following bulbs.

Map Light: 8 W



1. Pry on the edge of the cover using a flat-tip screwdriver to remove the cover.
► Wrap the flat-tip screwdriver with a cloth to prevent scratches.

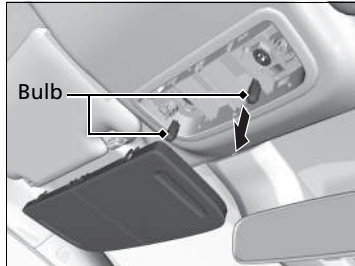

2. Remove the old bulb and insert a new bulb.

Models with colour audio system

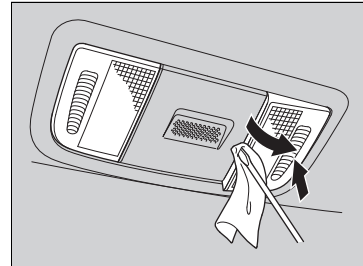

1. Pry on the edge of the cover using a flat-tip screwdriver to remove the cover.
► Wrap the flat-tip screwdriver with a cloth to prevent scratches.

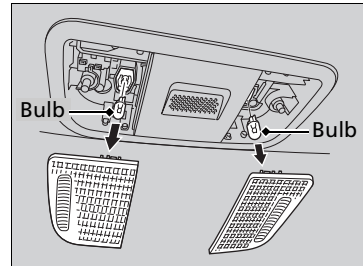

2. Remove the old bulb and insert a new bulb.

■ Luggage Area Light Bulb

When replacing, use the following bulbs.

Luggage Area Light: 5 W

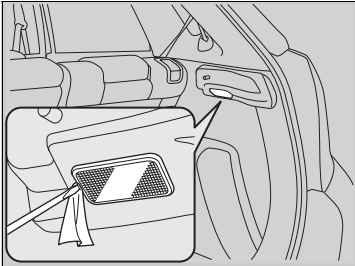

1. Pry on the edge of the cover using a flat-tip screwdriver to remove the cover.
 - ▶ Wrap the flat-tip screwdriver with a cloth to prevent scratches.

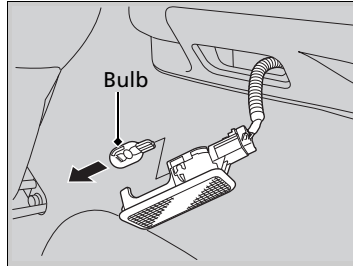

2. Remove the old bulb and insert a new bulb.

Checking Wiper Blades

If the wiper blade rubber has deteriorated, it will leave streaks and the hard surfaces of the blade may scratch the window glass.

Changing the Front Wiper Blade Rubber

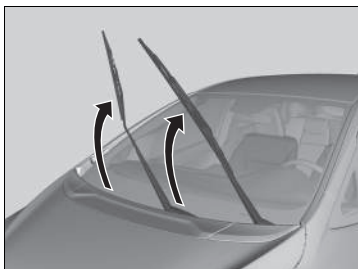

1. Lift the driver side wiper arm first, then the passenger side.

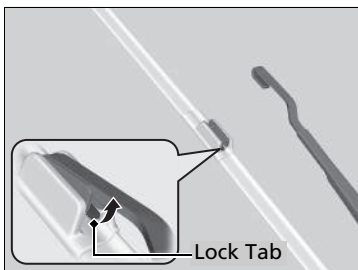

2. Press and hold the tab, then slide the blade from the wiper arm.

☒ Changing the Front Wiper Blade Rubber

NOTICE

Avoid dropping the wiper arm; it may damage the windshield.

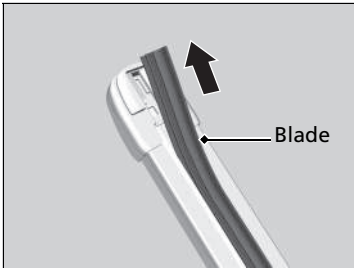

3. Slide the wiper blade out from its holder by pulling the tabbed end out.

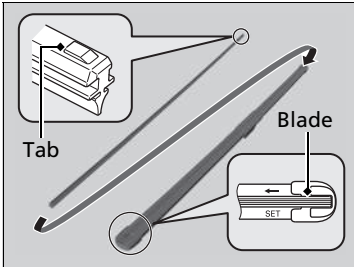

4. Slide the new wiper blade onto the holder from the bottom end.

▶ The tab on the blade should fit in the indent of the top of the wiper holder.

5. Slide the wiper blade onto the wiper arm securely.

6. Lower the passenger side wiper arm first, then the driver side.

Changing the Rear Wiper Blade Rubber

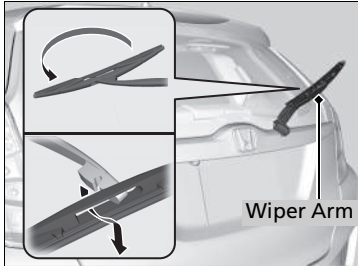

1. Raise the wiper arm off.
2. Pivot up the bottom end of the wiper blade until it comes off from the wiper arm.

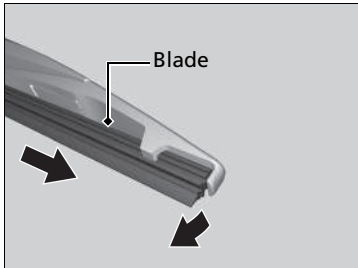

3. Slide the wiper blade out from the end with the indent.

▶▶ Changing the Rear Wiper Blade Rubber

NOTICE

Avoid dropping the wiper blade; it may damage the rear window.

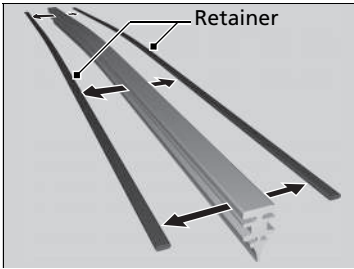

4. Remove the retainers from the rubber blade that has been removed, and mount to a new rubber blade.

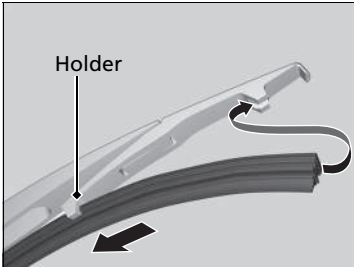

5. Slide the wiper blade onto the holder.
▶ Make sure it is engaged correctly, then install the wiper blade assembly onto the wiper arm.

Checking Tyres

To safely operate your vehicle, your tyres must be of the proper type and size, in good condition with adequate tread, and properly inflated.

■ Inflation guidelines

Properly inflated tyres provide the best combination of handling, tread life, and comfort. Refer to the driver's doorjamb label for the specified pressure.

Underinflated tyres wear unevenly, adversely affect handling and fuel economy, and are more likely to fail from overheating.

Overinflated tyres make your vehicle ride harshly, are more prone to road hazards, and wear unevenly.

Every day before you drive, look at each of the tyres. If one looks lower than the others, check the pressure with a tyre gauge.

At least once a month or before long trips, use a gauge to measure the pressure in all tyres, including the spare*. Even tyres in good condition can lose 10 to 20 kPa (0.1 to 0.2 kgf/cm², 1 to 2 psi) per month.

🔍 Checking Tyres

⚠️ WARNING

Using tyres that are excessively worn or improperly inflated can cause a crash in which you can be seriously hurt or killed.

Follow all instructions in this owner's manual regarding tyre inflation and maintenance.

Measure the air pressure when tyres are cold. This means the vehicle has been parked for at least three hours, or driven less than 1.6 km (1 mile). If necessary, add or release air until the specified pressure is reached.

If checked when hot, tyre pressure can be as much as 30–40 kPa (0.3–0.4 kgf/cm², 4–6 psi) higher than if checked when cold.

Have a dealer check the tyres if you feel a consistent vibration while driving. New tyres and any that have been removed and reinstalled should be properly balanced.

■ Inspection guidelines

Every time you check inflation, also examine the tyres and valve stems.

Look for:

- Bumps or bulges on the side or in the tread. Replace the tyre if you find any cuts, splits, or cracks in the side of the tyre. Replace it if you see fabric or cord.
- Remove any foreign objects and inspect for air leaks.
- Uneven tread wear. Have a dealer check the wheel alignment.
- Excessive tread wear.

➤ **Wear Indicators** P. 510

- Cracks or other damage around valve stem.

☒ Checking Tyres

High speed driving

Models with 185/55 R16 tyres

We recommend that you do not drive faster than the posted speed limits and conditions allow. If you drive at sustained high speeds (over 160 km/h/100 mph), adjust the cold tyre pressures as shown below to avoid excessive heat build up and sudden tyre failure.

Tyre Size	185/55R16 83H
Pressure	Front: 240 kPa (2.4 kgf/cm ² , 35 psi) Rear: 230 kPa (2.3 kgf/cm ² , 33 psi)

Wear Indicators

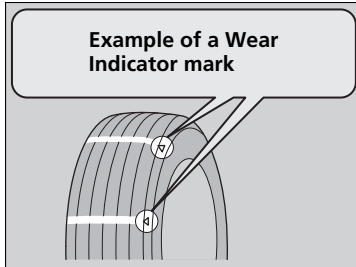

The groove where the wear indicator is located is 1.6 mm (1/16 inch) shallower than elsewhere on the tyre. If the tread has worn so that the indicator is exposed, replace the tyre.

Worn out tyres have poor traction on wet roads.

Tyre Service Life

The life of your tyres is dependent on many factors, including driving habits, road conditions, vehicle loading, inflation pressure, maintenance history, speed, and environmental conditions (even when the tyres are not in use).

In addition to regular inspections and inflation pressure maintenance, it is recommended that you have annual inspections performed once the tyres reach five years old. All tyres, including the spare*, should be removed from service after 10 years from the date of manufacture, regardless of their condition or state of wear.

Tyre and Wheel Replacement

Replace your tyres with radials of the same size, load range, speed rating, and maximum cold tyre pressure rating (as shown on the tyre's sidewall). Using tyres of a different size or construction can cause the ABS, VSA (vehicle stability assist) system, and hill start assist to work incorrectly.

It is best to replace all four tyres at the same time. If that isn't possible, replace the front or rear tyres in pairs.

Make sure that the wheel's specifications match those of the original wheels.

⚠ Tyre and Wheel Replacement

⚠ WARNING

Installing improper tyres on your vehicle can affect handling and stability. This can cause a crash in which you can be seriously hurt or killed.

Always use the size and type of tyres recommended in the tyre information label on your vehicle.

Tyre Rotation

Rotating tyres according to the maintenance schedule helps to distribute wear more evenly and increase tyre life.

■ Your Vehicle's Tyre Rotation Pattern

Rotate the tyres as shown here.

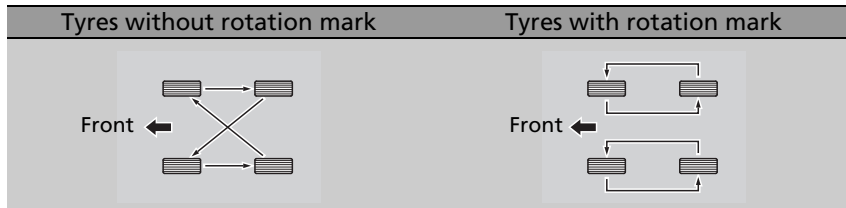

▣ Tyre Rotation

Tyres with directional tread patterns should only be rotated front to back (not from one side to the other). Directional tyres should be mounted with the rotation mark facing forward, as shown below.

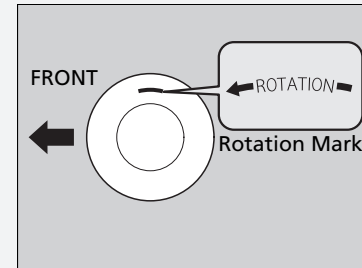

When the tyres are rotated, make sure the air pressures are checked.

Snow Traction Devices

If driving on snowy or frozen roads, mount winter tyres, or tyre chains; reduce speed; and maintain sufficient distance between vehicles when driving.

Be particularly careful when operating the steering wheel or brakes to prevent skidding.

Use tyre chains, winter tyres, or all season tyres when necessary or according to the law.

When mounting, refer to the following points.

For winter tyres:

- Select the size and load ranges that are the same as the original tyres.
- Mount the tyres to all four wheels.

☒ Snow Traction Devices

⚠ WARNING

Using the wrong chains, or not properly installing chains, can damage the brake lines and cause a crash in which you can be seriously injured or killed.

Follow all instructions in this owner's manual regarding the selection and use of tyre chains.

NOTICE

Traction devices that are the wrong size or improperly installed can damage your vehicle's brake lines, suspension, body, and wheels. Stop driving if they are hitting any part of the vehicle.

According to the EEC Directive for tyres, when winter tyres are used, it is necessary to affix a sticker with the allowable max. speed of the winter tyres clearly in the field of view of the driver, if the designed max. speed of vehicle is higher than the allowed max. speed of winter tyre. A sticker is obtainable from your tyre dealer. If you have any question, consult a dealer.

When tyre chains are mounted, follow the chain manufacturer's instructions regarding vehicle operational limits.

Use tyre chains only in an emergency or when they are legally required for driving through a certain area.

Use greater caution when driving with tyre chains on snow or ice. They may have less-predictable handling than good winter tyres without chains.

For tyre chains:

- Consult a dealer before purchasing any type of chains for your vehicle.
- Install them on the front tyres only.
- Because your vehicle has limited tyre clearance, we strongly recommend using the chains listed below:

Original Tyre Size*1	Chain Type
185/60R15 84H	RUD-matic classic 48479
185/55R16 83H	RUD-matic classic 48479

*1 : Original tyre size is mentioned on the tyre information label on the driver's doorjamb.

- Follow the chain manufacturer's instruction when installing. Mount them as tightly as you can.
- Check that the chains do not touch the brake lines or suspension.
- Drive slowly.

Checking the Battery

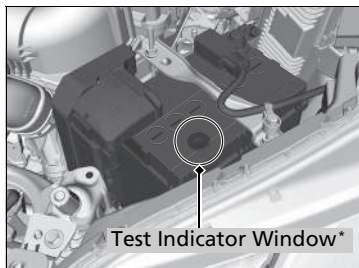

On the battery with test indicator

Check the battery condition monthly. Look at the test indicator window and check the terminals for corrosion.

On the battery without the test indicator

Check the battery condition monthly and check the terminals for corrosion. Check the battery condition by looking at the fluid level. The upper and lower level marks are shown on the battery case. If the fluid level is below the lower mark, contact a dealer.

If your vehicle's battery is disconnected or goes dead:

- The clock resets.
 - **Clock** P. 138
- The audio system is disabled.
 - **Reactivating the audio system** P. 218
- The navigation system is disabled. A PIN code will be required.
 - **Refer to the navigation system manual**

* Not available on all models

Battery

⚠ WARNING

The battery gives off explosive hydrogen gas during normal operation.

A spark or open flame can cause the battery to explode with enough force to kill or seriously hurt you.

Keep all sparks, open flames, and smoking materials away from the battery.

Wear protective clothing and a face shield, or have a skilled technician do any battery maintenance.

⚠ WARNING

The battery contains sulfuric acid (electrolyte) which is highly corrosive and poisonous.

Getting electrolyte in your eyes or on your skin can cause serious burns. Wear protective clothing and eye protection when working on or near the battery.

Swallowing electrolyte can cause fatal poisoning if immediate action is not taken.

KEEP OUT OF THE REACH OF CHILDREN

Charging the Battery

Disconnect both battery cables to prevent damaging your vehicle's electrical system. Always disconnect the negative (-) cable first, and reconnect it last.

▶▶ Battery

Models with test indicator window on the battery

The test indicator's colour information is on the battery.

The location of the test indicator window may vary depending on the model.

Emergency Procedures

Eyes: Flush with water from a cup or other container for at least 15 minutes. (Water under pressure can damage the eye.) Call a physician immediately.

Skin: Remove contaminated clothing. Flush the skin with large quantities of water. Call a physician immediately.

Swallowing: Drink water or milk. Call a physician immediately.

When you find corrosion, clean the battery terminals by applying a baking powder and water solution. Clean terminals with a damp towel. Cloth/towel dry the battery. Coat the terminals with grease to help prevent future corrosion.

Replacing Battery

When you remove and replace the battery, always follow the maintenance safety and the warnings for when checking the battery to prevent potential hazards.

🔧 **Maintenance Safety** P. 471

🔧 **Checking the Battery** P. 515

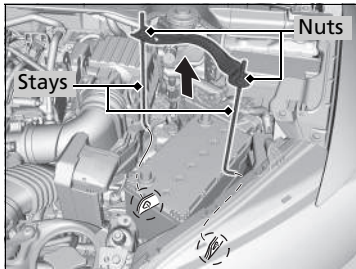
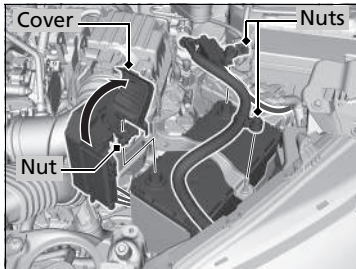

1. Turn the ignition switch to LOCK *1. Open the bonnet.
2. Loosen the nut on the negative battery cable, then disconnect the cable from the negative (-) terminal.
3. Open the positive battery terminal cover. Loosen the nut on the positive battery cable, then disconnect the cable from the positive (+) terminal.
4. Loosen the nut on each side of the battery bracket with a wrench.
5. Pull the bottom end of each battery stay out of the hole on the battery base, and remove the combination of the battery bracket and the stays.

▶▶ Replacing Battery

NOTICE

An improperly disposed of battery can be harmful to the environment and human health. Always confirm local regulations for battery disposal.

This symbol on the battery means that this product must not be treated as household waste.



*1: Models with the keyless access system have an **ENGINE START/STOP** button instead of an ignition switch.

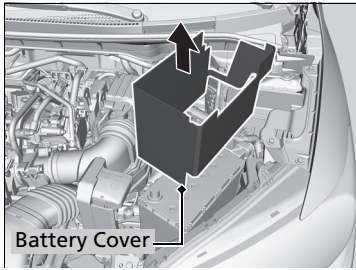

6. Remove the battery cover.

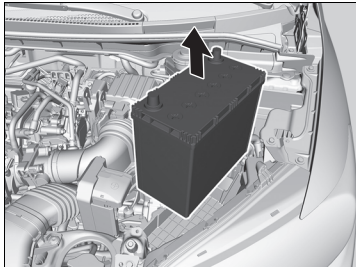

7. Take out the battery carefully.

▶▶ Replacing Battery

Always disconnect the negative (-) cable first, and reconnect it last.

To install a new battery, reverse this procedure.

The battery installed in this vehicle is specifically designed for a model with Auto Idle Stop. Using a battery other than this specified type may shorten the battery life, and prevent Auto Idle Stop from activating. If you need to replace the battery, make sure to select the specified type. Ask a dealer for more details.

▶ **Battery** P. 582

Battery Label



Example

⌘ Battery Label

Danger

- Keep flames and sparks away from the battery. The battery produces explosive gas that can cause an explosion.
- Wear eye protection and rubber gloves when handling the battery to avoid risk of burns or loss of eyesight if exposed to battery electrolyte.
- Do not allow children to handle the battery, under any circumstance. Ensure that anyone handling the battery has a proper understanding of the hazards and correct handling procedures involved.
- Handle battery electrolyte with extreme care, as it contains dilute sulfuric acid. Exposure to eyes or skin can cause burns or loss of eyesight.
- Read this manual carefully, and understand it before handling the battery. Failure to do so can cause personal injury and damage to the vehicle.
- Do not use the battery if the level of electrolyte is at or below the recommended level. Using the battery with low electrolyte can cause it to explode, causing serious injury.

Replacing the Button Battery

If the indicator does not come on when the button is pressed, replace the battery.

■ Retractable Key*

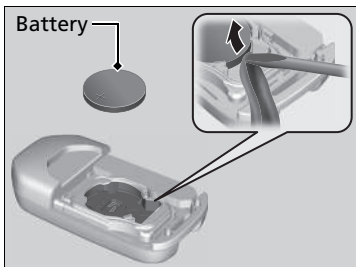
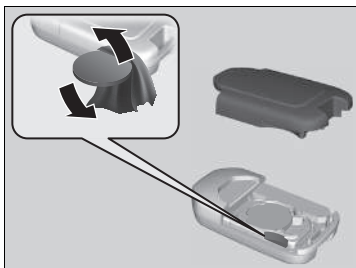

Battery type: CR2032

1. Remove the upper half of the cover by carefully prying on the edge with a coin.
▶ Wrap a coin with a cloth to prevent scratching the retractable key.
2. Remove the button battery with the small flat-tip screwdriver.
3. Make sure to replace the battery with the correct polarity.

▶▶ Replacing the Button Battery

NOTICE

An improperly disposed of battery can damage the environment. Always confirm local regulations for battery disposal.

Replacement batteries are commercially available or at a dealer.

This symbol on the battery means that this product must not be treated as household waste.



■ Keyless Remote *



Battery type: CR2032

1. Remove the built-in key.

2. Remove the upper half of the cover by carefully prying on the edge with a coin.
 - ▶ Remove carefully to avoid losing the buttons.
 - ▶ Wrap a coin with a cloth to prevent scratching the keyless remote.

3. Make sure to replace the battery with the correct polarity.

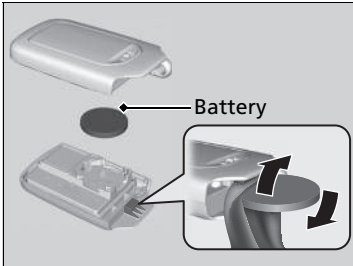

* Not available on all models

Air Conditioning

For proper and safe operation of the heating and cooling system /climate control system, the refrigerant system should only be served by a qualified technician.

Never repair or replace the air conditioning evaporator (cooling coil) with one removed from a used or salvaged vehicle.

» Air Conditioning





NOTICE

Vented refrigerant is harmful to the environment. To avoid refrigerant from venting, never replace the evaporator with one removed from a used or salvaged vehicle.

Refrigerant in your vehicle's air conditioning system is flammable and can be ignited during servicing if proper procedures are not followed.

The air conditioner label is found under the bonnet:



-  : Caution
-  : Flammable Refrigerant
-  : Requires a qualified technician to service
-  : Air Conditioning System

Dust and Pollen Filter

■ When to Replace the Dust and Pollen Filter

Replace the dust and pollen filter according to your vehicle's recommended maintenance schedule. It is recommended to replace the filter even sooner if the vehicle has been driven in a dusty environment.

✦ **Maintenance Schedule*** P. 478

✦ **Service Reminder System*** P. 473

■ How to Replace the Dust and Pollen Filter

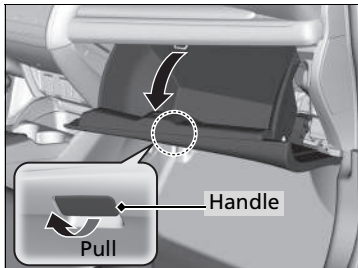

1. Open the glove box.

✦ Dust and Pollen Filter

Using an air freshener may reduce the deodorizing effect of the dust and pollen filter, and may reduce its life.

If the airflow from the heating and cooling system*/climate control system* deteriorates noticeably, and the windows fog up easily, the filter may need to be replaced.

The dust and pollen filter collects pollen, dust, and other debris in the air.

* Not available on all models

Continued

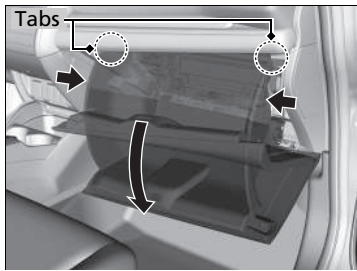

2. Disengage the two tabs by pushing on each side panel.
3. Pivot the glove box out of the way.

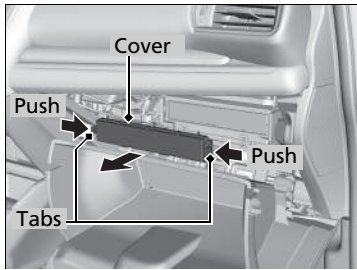

4. Push in the tabs on the corners of the filter case cover, and remove it.

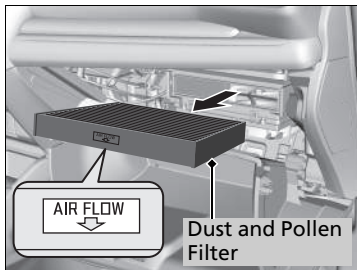

5. Remove the filter from the case.
6. Install a new filter in the case.
 - Put the **AIR FLOW** arrow directed side down.

►► Dust and Pollen Filter

If you are not sure how to replace the dust and pollen filter, have it replaced by a dealer.

Interior Care

Use a vacuum cleaner to remove dust before using a cloth.

Use a damp cloth with a mixture of mild detergent and warm water to remove dirt.

Use a clean cloth to remove detergent residue.

Cleaning Seat Belts

Use a soft brush with a mixture of mild soap and warm water to clean the seat belts.

Let the belts air dry. Wipe the loop of the seat belt anchors using a clean cloth.



Cleaning the Window

Wipe using a glass cleaner.

Interior Care

Do not spill liquids inside the vehicle.

Electrical devices and systems may malfunction if liquids are splashed on them.

Do not use silicone based sprays on electrical devices such as audio devices and switches.

Doing so may cause the items to malfunction or a fire inside the vehicle.

If a silicone based spray is inadvertently used on electrical devices, consult a dealer.

Depending on their composition, chemicals and liquid aromatics may cause discolouration, wrinkles, and cracking to resin-based parts and textiles.

Do not use alkali solvents or organic solvents such as benzene or petrol.

After using chemicals, make sure to gently wipe them off using a dry cloth.

Do not place used cloths on top of resin based parts or textiles for long periods of time without washing.

Be careful not to spill a liquid type air freshener.

Cleaning the Window

Wires are mounted to the inside of the rear window. Wipe along the same direction as the wires with a soft cloth so as not to damage them.

■ Floor Mats*

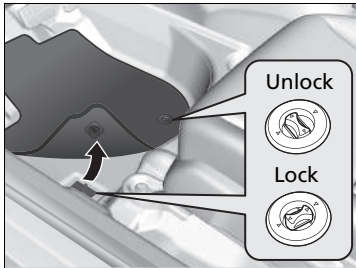

The driver's floor mat hooks over the floor anchors, which keep the mat from sliding forward. To remove a mat for cleaning, turn the anchor knobs to the unlock position. When reinstalling the mat after cleaning, turn the knobs to the lock position.

Do not put additional floor mats on top of the anchored mat.

■ Maintaining Genuine Leather*

Vacuum dirt and dust from the leather frequently. Pay close attention to the pleats and seams. Clean the leather with a soft cloth dampened with a 90% water and 10% neutral soap solution. Then buff it with a clean, dry cloth. Remove any dust or dirt on leather surfaces immediately.

⌘ Floor Mats*

If you use any floor mats that were not originally provided with your vehicle, make sure they are designed for your specific vehicle, fit correctly, and are securely anchored by the floor anchors. Position the rear seat floor mats properly. If they are not properly positioned, the floor mats can interfere with the front seat functions.

Exterior Care

Dust off the vehicle body after you drive.

Regularly inspect your vehicle for scratches on painted surfaces. A scratch on a painted surface can result in body rust. If you find a scratch, promptly repair it.

■ Washing the Vehicle

Wash the vehicle frequently. Further, make sure to wash the vehicle in the following circumstances:

- If driving on roads with road salt.
- If driving in coastal areas.
- If tar, soot, bird droppings, insects, or tree sap are stuck to painted surfaces.

■ Using an Automated Car Wash

- Remove or store the audio antenna*.

▶ **Audio Antenna** P. 217

- Fold in the door mirrors.
- Turn off the automatic intermittent wipers.

Make sure to follow the instructions indicated on the automated car wash.

■ Using High Pressure Cleaners

- Keep sufficient distance between the cleaning nozzle and the vehicle body.
- Take particular care around the windows. Standing too close may cause water to enter the vehicle interior.
- Do not spray high pressure water directly into the engine compartment. Instead, use low pressure water and a mild detergent.

* Not available on all models

Continued

▶▶ Washing the Vehicle

Do not spray water into the air intake vents or engine compartment. It can cause a malfunction.

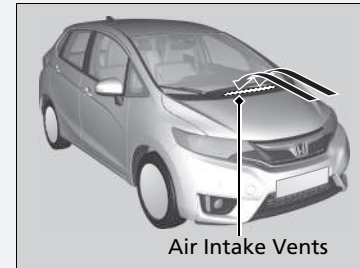

■ Applying Wax

A good coat of automotive body wax helps protect your vehicle's paint from the elements. Wax will wear off over time and expose your vehicle's paint to the elements, so reapply as necessary.

■ Maintaining the Bumpers and Other Resin Coated Parts

If you get petrol, oil, engine coolant, or battery fluid on resin coated parts, they may be stained or the coating may peel. Promptly wipe it away using a soft cloth and water.

■ Cleaning the Window

Wipe using a glass cleaner.

■ Maintaining Aluminium Wheels*

Aluminium is susceptible to deterioration caused by salt and other road contaminants. Use a sponge and mild detergent to wipe away promptly. Be careful not to use harsh chemicals (including some commercial wheel cleaners) or a stiff brush. They can damage the clear coat of the aluminium alloy wheels that helps to keep the aluminium from corroding and tarnishing.

» Applying Wax

NOTICE

Chemical solvents and strong cleaners can damage the paint, metal, and plastic on your vehicle. Wipe up spills immediately.

» Maintaining the Bumpers and Other Resin Coated Parts

Ask a dealer about the correct coating material when you want to repair the painted surface of the parts made of resin.

■ Fogged Exterior Light Lenses

The inside lenses of exterior lights (headlights, brake lights etc.) may fog temporarily if you have driven in the rain, or after the vehicle has been run through a car wash. Dew condensation also may build up inside the lenses when there is a significant enough difference between the ambient and inside lens temperatures (similar to vehicle windows fogging up in rainy conditions). These conditions are natural processes, not structural design problems in the exterior lights.

Lens design characteristics may result in moisture developing on the light lens frame surfaces. This also is not a malfunction.

However, if you see large amounts water accumulation, or large water drop building up inside the lenses, have your vehicle inspected by a dealer.

Handling the Unexpected

This chapter explains how to handle unexpected troubles.

Tools

Types of Tools..... 532

If a Tyre Goes Flat

Changing a Flat Tyre* 533

Temporarily Repairing a Flat Tyre..... 541

Engine Does Not Start

Checking the Engine 551

If the Keyless Remote Battery is Weak .. 552

Emergency Engine Stop 553

Jump Starting..... 554

Shift Lever Does Not Move..... 557

Overheating

How to Handle Overheating..... 558

Indicator, Coming On/Blinking

If the Low Oil Pressure Indicator Comes

On 560

If the Charging System Indicator Comes

On 560

If the Malfunction Indicator Lamp Comes

On or Blinks 561

If the Brake System Indicator (Red)

Comes On..... 561

If the Electric Power Steering (EPS) System

Indicator Comes On..... 562

If the Low Tyre Pressure/Deflation Warning

System Indicator Comes On or Blinks... 563

If the Low Oil Level Symbol Appears 564

Fuses

Fuse Locations 565

Inspecting and Changing Fuses..... 575

Emergency Towing..... 576

When You Cannot Open the Tailgate 579

* Not available on all models

Types of Tools

Models with a compact spare tyre

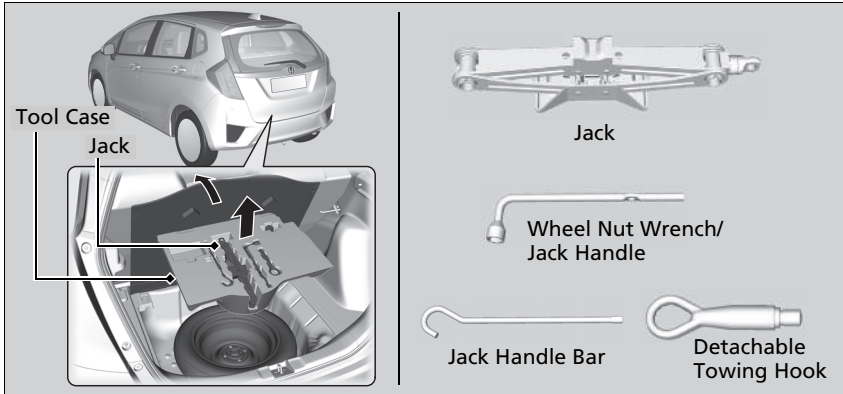

Models with temporary tyre repair kit

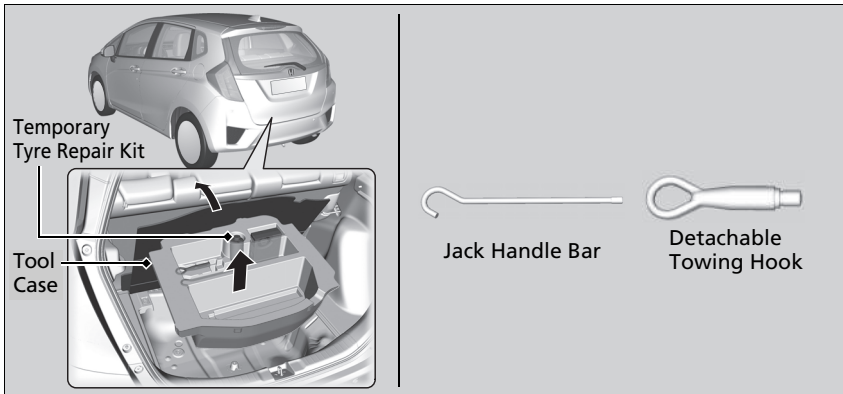

Types of Tools

The tools are stored in the luggage area.

Changing a Flat Tyre*

If a tyre goes flat while driving, grasp the steering wheel firmly, and brake gradually to reduce speed. Then, stop in a safe place. Replace the flat tyre with a compact spare tyre. Go to a dealer as soon as possible to have the full-size tyre repaired or replaced.

1. Park the vehicle on firm, level, and non-slippery surface and apply the parking brake.

Continuously variable transmission models

2. Move the shift lever to **P**.

Manual transmission models

2. Move the shift lever to **R**.

All models

3. Turn on the hazard warning lights and turn the ignition switch to LOCK **0***1.

*1: Models with the keyless access system have an **ENGINE START/STOP** button instead of an ignition switch.

* Not available on all models

Changing a Flat Tyre*

Follow compact spare precautions:

Periodically check the tyre pressure of the compact spare. It should be set to the specified pressure.
Specified Pressure: 420 kPa (4.2 kgf/cm², 60 psi)

When driving with the compact spare tyre, keep the vehicle speed under 80 km/h (50 mph). Replace with a full-size tyre as soon as possible.

The compact spare tyre and wheel in your vehicle are specifically for this model.

Do not use them with another vehicle.

Do not use another type of compact spare tyre or wheel with your vehicle.

Do not mount tyre chains on a compact spare tyre. If a chain-mounted front tyre goes flat, remove one of the full-size rear tyres and replace it with the compact spare tyre. Remove the flat front tyre and replace it with the full-size tyre that was removed from the rear. Mount the tyre chains on the front tyre.

This tyre gives a harsher ride and less traction on some road surfaces. Use greater caution while driving.

Do not use more than one compact spare tyre at the same time.

The compact spare tyre is smaller than the full-size tyre. Your vehicle's ground clearance reduces when the compact spare tyre is installed. Driving over road debris or bumps could possibly damage the underside of your vehicle.

■ Getting Ready to Replace the Flat Tyre

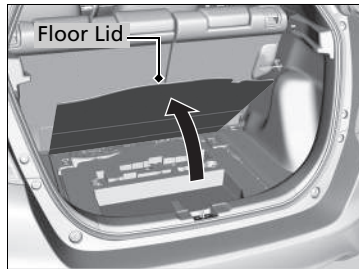

1. Open the luggage area floor lid.

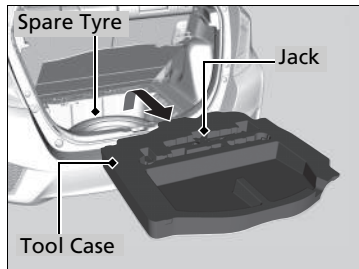

2. Take the tool case out of the luggage area.
3. Take the wheel nut wrench, jack handle bar and jack out of the tool case.
4. Unscrew the wing bolt, and remove the spacer cone. Then, remove the spare tyre.

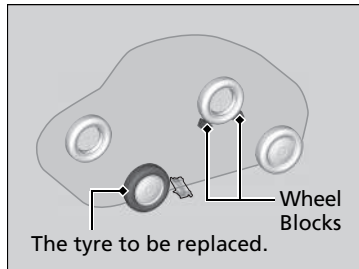

5. Place a wheel block or rock in front and rear of the wheel diagonal to the flat tyre.

✘ Changing a Flat Tyre*

WARNING: The jack can only be used for helping an emergency vehicle breakdown, not for changing the regular seasonal tyre or any other normal maintenance or repair operation.

NOTICE

Do not use the jack if it doesn't work properly. Call your dealer or a professional towing service.

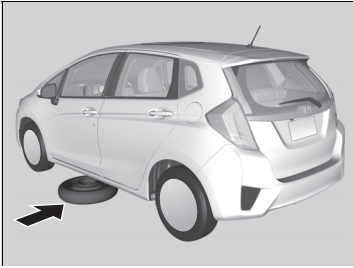

6. Place the spare tyre (wheel side up) under the vehicle body, near the tyre that needs to be replaced.

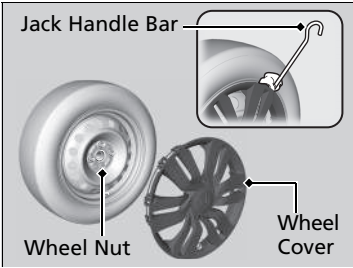

Models with wheel cover

7. Put the flat tip of the jack handle bar into the edge of the wheel cover. Carefully pry the edge and remove the cover.
 - Wrap a cloth around the flat tip of the jack handle bar to prevent scratches on the cover.

All models

8. Loosen each wheel nut about one turn using the wheel nut wrench.



How to Set Up the Jack

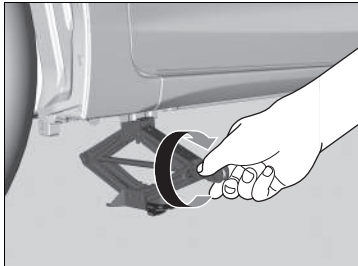
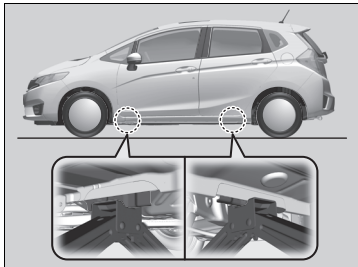

1. Place the jack under the jacking point closest to the tyre to be changed.
2. Turn the end bracket clockwise as shown in the image until the top of the jack contacts the jacking point.
 - ▶ Make sure that the jacking point tab is resting in the jack notch.

How to Set Up the Jack

⚠ WARNING

The vehicle can easily roll off the jack, seriously injuring anyone underneath.

Follow the directions for changing a tyre exactly, and no person should place any portion of their body under a vehicle that is supported by a jack.

WARNING: The jack shall be placed on a flat and stable surface on the same level as the vehicle is parked.

The jack that came with your vehicle has the following label.

1.	2.	3.

1. See Owner's Manual.
2. Never get under vehicle when supported by jack.
3. Place jack underneath reinforced area.

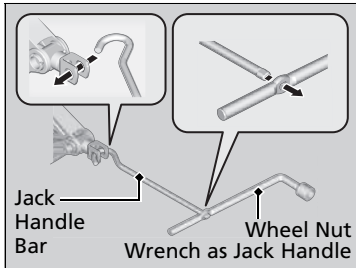

3. Raise the vehicle, using the jack handle bar and the jack handle, until the tyre is off the ground.

⌘ How to Set Up the Jack

Do not use the jack with people or luggage in the vehicle.

Use the jack provided in your vehicle. Other jacks may not support the weight ("load") or may not fit the jacking point.

The following instructions must be followed to use the jack safely:

- Do not use while the engine is running.
- Use only where the ground is firm and level.
- Use only at the jacking points.
- Do not get in the vehicle while using the jack.
- Do not put anything on top of or underneath the jack.

■ Replacing the Flat Tyre

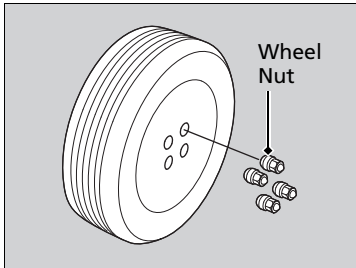

1. Remove the wheel nuts and flat tyre.

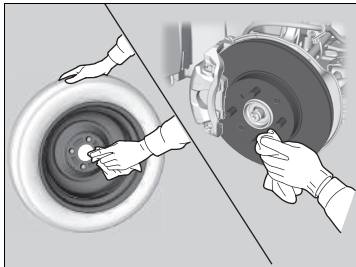

2. Wipe the mounting surfaces of the wheel with a clean cloth.

3. Mount the spare tyre.

4. Screw the wheel nuts until they touch the lips around the mounting holes, and stop rotating.

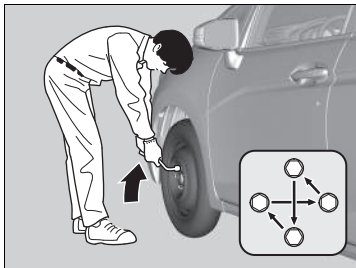

5. Lower the vehicle and remove the jack. Tighten the wheel nuts in the order indicated in the image. Go around, tightening the nuts, two to three times in this order.

Wheel nut torque:

108 N·m (11 kgf·m, 80 lbf·ft)

▶▶ Replacing the Flat Tyre

Do not over tighten the wheel nuts by applying extra torque using your foot or a pipe.

Models with wheel cover

Make sure the wire support ring is hooked into the clips around the edge of the wheel cover.

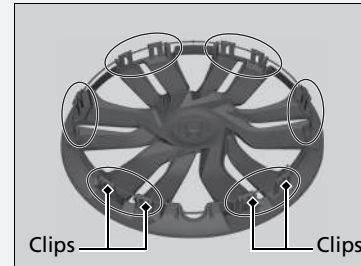

Align the valve mark on the wheel cover to the tyre valve on the wheel, then install the wheel cover.

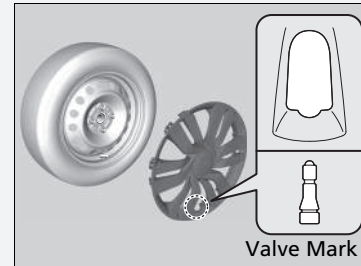

Storing the Flat Tyre

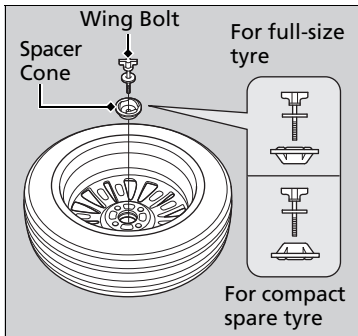

Models with aluminium wheels

1. Remove the centre cap.
2. Remove the spacer cone from the wing bolt, flip it over, and insert it back on the bolt.

Models with a compact spare tyre

All models

3. Place the flat tyre face down in the spare tyre well.
4. Secure the flat tyre with the wing bolt.
5. Securely put the jack and wheel nut wrench back in the tool case.
6. Store the case in the luggage area.

Storing the Flat Tyre

⚠ WARNING

Loose items can fly around the interior in a crash and can seriously injure the occupants.

Store the wheel, jack, and tools securely before driving.

Models with wheel cover

Make sure the wire support ring is on the outer side of the tyre valve as shown.

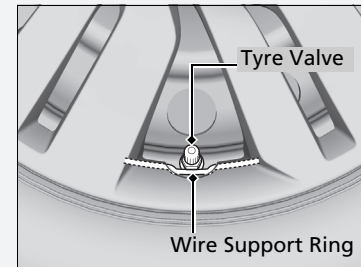

Continued

■ Deflation Warning System and the Spare Tyre

If you replace a flat tyre with the spare tyre,  indicator comes on while you are driving. After driving for a few kilometres (miles), the indicator will start blinking for a short time and then stay on, but this is normal.

Calibrate the deflation warning system when you replace the tyre with a specified regular tyre.

➤ **Deflation Warning System Calibration** P. 443

Temporarily Repairing a Flat Tyre

If the tyre has a large cut or is otherwise severely damaged, you will need to have the vehicle towed. If the tyre only has a small puncture, from a nail for instance, you can use the temporary tyre repair kit so that you can drive to the nearest service station for a permanent repair.

If a tyre goes flat while driving, grasp the steering wheel firmly, and brake gradually to reduce speed. Then stop in a safe place.

1. Park the vehicle on firm, level, and non-slippery ground and apply the parking brake.

Continuously variable transmission models

2. Move the shift lever to **P**.

Manual transmission models

2. Move the shift lever to **R**.

All models

3. Turn on the hazard warning lights and turn the ignition switch to LOCK **0***1.
 - When towing a trailer, unhitch the trailer.

*1: Models with the keyless access system have an **ENGINE START/STOP** button instead of an ignition switch.

Temporarily Repairing a Flat Tyre

The kit should not be used in the following situations. Instead, contact a dealer or roadside assistant to have the vehicle towed.

- The tyre sealant has expired.
- More than one tyre is punctured.
- The puncture or cut is greater than 4 mm (3/16 inch).
- The tyre side wall is damaged or the puncture is outside the tyre tread.

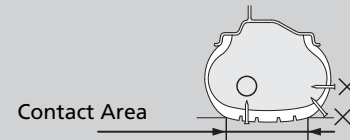

When the puncture is:	Kit Use
Smaller than 4 mm (3/16 inch)	Yes
Larger than 4 mm (3/16 inch)	No

- Damage has been caused by driving with the tyres extremely under inflated.
- The tyre bead is no longer seated.
- The rim is damaged.

Do not remove a nail or screw that punctured the tyre. If you remove it from the tyre, you may not be able to repair the puncture using the kit.

■ Getting Ready to Temporarily Repair the Flat Tyre

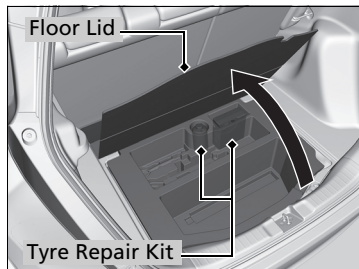
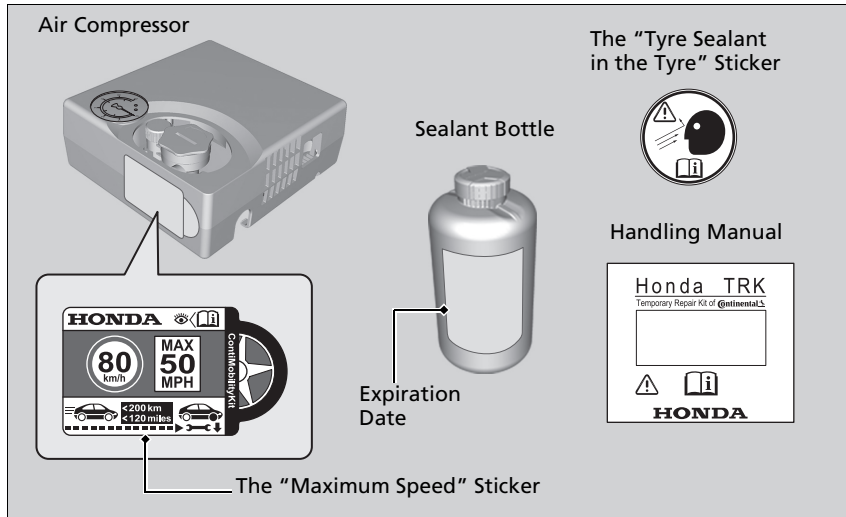

1. Open the luggage area floor lid, then take the kit out of the tool box.
2. Place the kit, face up, on flat ground near the flat tyre, away from traffic. Do not place the kit on its side.

▶▶ Getting Ready to Temporarily Repair the Flat Tyre

When making a temporary repair, carefully read the instruction manual provided with the kit.

Injecting the Sealant and Air in the Tyre

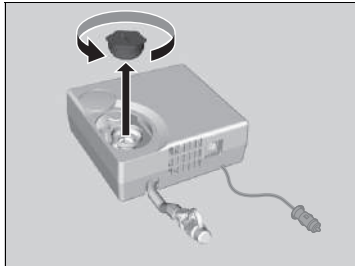
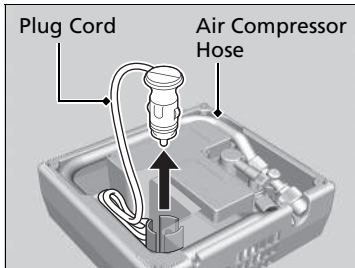

1. Take the air compressor hose and plug cord out of the back of the air compressor.

2. Remove the cap from the air compressor.

3. Shake the bottle well.

Injecting the Sealant and Air in the Tyre

⚠ WARNING

Tyre sealant contains substances that are harmful and can be fatal if swallowed.

If accidentally swallowed, do not induce vomiting. Drink plenty of water and get medical attention immediately.

For skin or eye contact, flush with cool water and get medical attention if necessary.

Keep the sealant bottle out of the reach of children.

In cold temperatures, the sealant may not flow easily. In this situation, warm it by keeping the bottle in the passenger compartment before using.

The sealant can permanently stain clothing and other materials. Be careful during handling and wipe away any spills immediately.

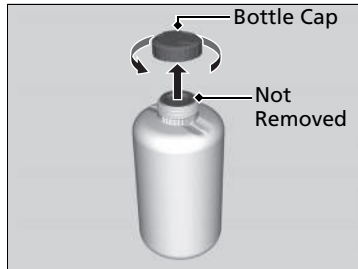

4. Remove the bottle cap.
 - ▶ Do not remove the sealed cover.

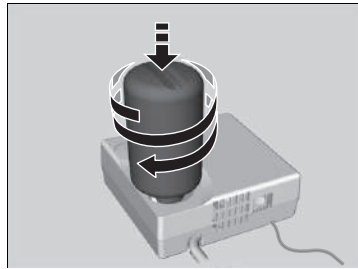

5. Screw the sealed bottle onto the air compressor.
 - ▶ Screw the bottle tightly so that it does not become loose.

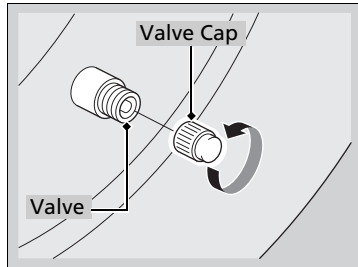

6. Unscrew the valve cap.

✎ Injecting the Sealant and Air in the Tyre

Do not remove the empty bottle after injecting the sealant.

See a Honda dealer for a replacement of sealant bottle and proper disposal of the empty bottle.

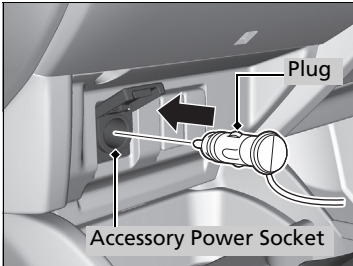
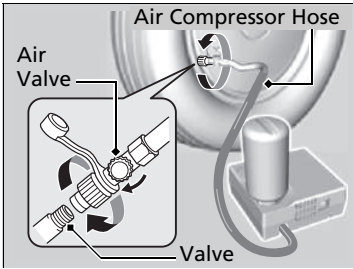

7. Screw the air compressor hose onto the tyre valve.
 - ▶ Make sure the air valve is closed and the air compressor is turned off.
8. Plug in the compressor to the accessory power socket.
 - **Accessory Power Socket(s)** P. 200
9. Start the engine.
 - **Carbon Monoxide Gas** P. 81

▶▶ Injecting the Sealant and Air in the Tyre

⚠ WARNING

Running the engine with the vehicle in an enclosed or even partly enclosed area can cause a rapid build-up of toxic carbon monoxide.

Breathing this colourless, odourless gas can cause unconsciousness and even death. Only run the engine to power the air compressor with the vehicle outdoors.

Turn the air compressor off when connecting the air compressor hose.

You hear a motor sound coming from the activated air compressor. This is normal.

If the required air pressure is not reached within 10 minutes, the tyre may be too severely damaged for the kit to provide the necessary seal and your vehicle will need to be towed.

If you want to measure the air pressure using a gauge, turn the air compressor off first.

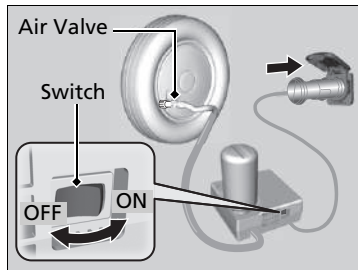

10. Turn on the air compressor and inflate the tyre to the required air pressure.
 - ▶ The compressor starts injecting sealant and air into the tyre.
 - ▶ Refer to the driver's doorjamb label for the specified pressure.
11. After the air pressure reaches to specified pressure, turn off the compressor.
 - ▶ Check the air pressure gauge on the air compressor.
 - ▶ If overinflated, release the air by turning the air valve. Be careful not to spill any sealant.
12. Unplug the plug from the accessory power socket.
13. Unscrew the air compressor hose from the tyre valve. Install the hose cap.
 - ▶ Be careful not to spill any sealant when the hose is disconnected. Wipe away any spills.
14. Apply the wheel label to the flat surface of the wheel.
 - ▶ The wheel surface must be clean to ensure the label adheres properly.
15. Store the tyre repair kit in the luggage area.
 - ▶ Do not remove the sealant bottle from the air compressor.

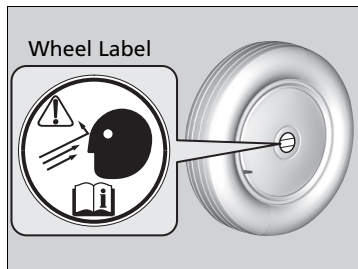

▶▶ Injecting the Sealant and Air in the Tyre

Inform the use of tyre sealant when you ask a Honda dealer or the road assistant service for replacing or repairing the flat tyre.

This air compressor is designed for the automotive tyre. Check the following:

- The power supply of the air compressor is limited to your vehicle's 12-volt DC accessory power socket.
- Do not operate the temporary tyre repair kit compressor for more than 15 minutes. The compressor can overheat and become permanently damaged. Make it cool down when using the compressor continuously.

■ Checking the Air Pressure

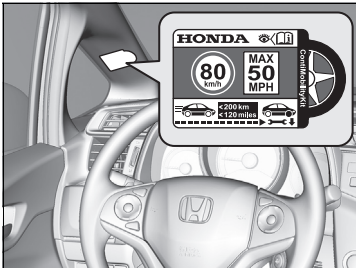

1. Apply the speed limit label to the location as shown.
2. Drive the vehicle for about 10 minutes or three to ten kilometres (two to six miles).
 - ▶ Do not exceed 80 km/h (50 mph).
3. Stop the vehicle at a safe place.
4. Check the air pressure using the gauge on the air compressor.
 - ▶ Do not turn the air compressor on to check the pressure.

☒ Checking the Air Pressure

⚠ WARNING

Running the engine with the vehicle in an enclosed or even partly enclosed area can cause a rapid build-up of toxic carbon monoxide.

Breathing this colourless, odourless gas can cause unconsciousness and even death. Only run the engine to power the air compressor with the vehicle outdoors.

Continued

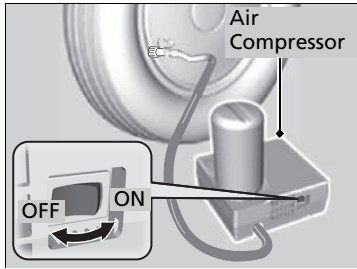

5. If the air pressure is

- Less than 130 kPa (19 psi): Do not add air and continue driving. The leak is too severe. Call for help and have your vehicle towed.

➤ **Emergency Towing** P. 576

- Required air pressure (See the label on driver's doorjamb.) or more: Continue driving until you reach the nearest service station. Do not exceed 80 km/h (50 mph).
- Greater than 130 kPa (19 psi), but less than required air pressure (See the label on driver's doorjamb.): Inflate the tyre to the required air pressure.

➤ **Adding the Air in the Tyre** P. 549

And repeat steps 2 to 4 until you reach the nearest service station. Do not exceed 80 km/h (50 mph).

- The distance to the nearest service station has to be within about 200 kilometres (120 miles).

6. Repackage and properly stow the kit.

☒ **Checking the Air Pressure**

Make sure to store the air compressor with the empty bottle in the luggage area.

■ Adding the Air in the Tyre

You can use the kit to inflate a non-punctured under-inflated tyre.

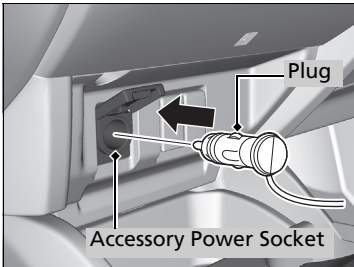
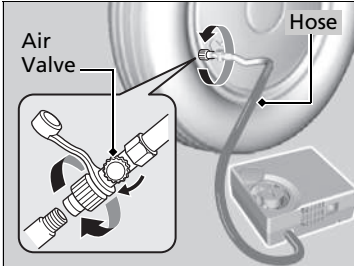

1. Take the air compressor out of the luggage area.
2. Place the kit, face up, on flat ground near the tyre to inflate, away from traffic. Do not place the kit on its side.
3. Remove the valve cap.
4. Attach the hose onto the tyre valve. Screw it until it is tight.
 - Make sure the air valve is closed.
5. Plug in the compressor to the accessory power socket.
 - Be careful not to pinch the cord in a door or window.
 - **Accessory Power Socket(s)** P. 200
 - **Carbon Monoxide Gas** P. 81
6. Start the engine.

►► Adding the Air in the Tyre

⚠ WARNING

Running the engine with the vehicle in an enclosed or even partly enclosed area can cause a rapid build-up of toxic carbon monoxide.

Breathing this colourless, odourless gas can cause unconsciousness and even death. Only run the engine to power the air compressor with the vehicle outdoors.

You hear a motor sound coming from the activated air compressor. This is normal.

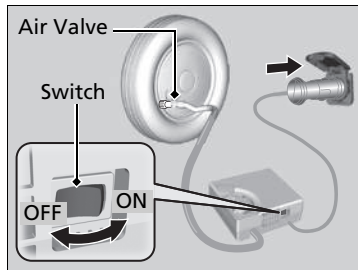

7. Turn on the air compressor and inflate the tyre to the required air pressure (See the label on driver's doorjamb.)
8. Turn off the air compressor.
 - ▶ Check the air pressure gauge on the air compressor.
 - ▶ If overinflated, turn the air valve to deflate.
9. Turn off the engine, then unplug the air compressor from the accessory power socket.
10. Unscrew the air compressor hose from the tyre valve. Reinstall the valve cap.
11. Store the air compressor in the luggage area.

✎ Adding the Air in the Tyre

This air compressor is designed for the automotive tyre. Check the following:

- The power supply of the air compressor is limited to your vehicle's 12-volt DC accessory power socket.
- Do not operate the temporary tyre repair kit compressor for more than 15 minutes. The compressor can overheat and become permanently damaged.
Make it cool down when using the compressor continuously.

If you want to measure the air pressure using a gauge, turn the air compressor off first.

Checking the Engine

If the engine does not start, check the starter.

Checking the Engine

If you must start the vehicle immediately, use an assisting vehicle to jump start it.

➤ **Jump Starting** P. 554

Starter condition

Checklist

Starter doesn't turn or turns over slowly.

The battery may be dead. Check each of the items on the right and respond accordingly.

Models with keyless access system

Check for an indication on the multi-information display.

- If  appears.
 - **If the Keyless Remote Battery is Weak** P. 552
- ▶ Make sure the keyless remote is in its operating range.
 - **ENGINE START/STOP Button Operating Range** P. 162

Check the brightness of the interior lights.

Turn on the interior lights and check the brightness.

- If the interior lights are dim or do not come on at all ➤ **Battery** P. 515
- If the interior lights come on normally ➤ **Fuses** P. 565

The starter turns over normally but the engine doesn't start.

There may be a problem with the fuse. Check each of the items on the right and respond accordingly.

Review the engine start procedure.

Follow its instructions, and try to start the engine again.

➤ **Starting the Engine** P. 386, 389

Check the immobilizer system indicator.

When the immobilizer system indicator is blinking, the engine cannot be started.

➤ **Immobilizer System** P. 156

Check the fuel level.

There should be enough fuel in the tank.

➤ **Fuel Gauge** P. 126

Check the fuses.

Check all fuses, or have your vehicle checked by a dealer.

➤ **Inspecting and Changing Fuses** P. 575

If the problem continues:

➤ **Emergency Towing** P. 576

Models with keyless access system

If the Keyless Remote Battery is Weak

If the beeper sounds,  appears on the multi-information display, and the indicator on the **ENGINE START/STOP** button flashes, and the engine does not start.

Start the engine as follows.

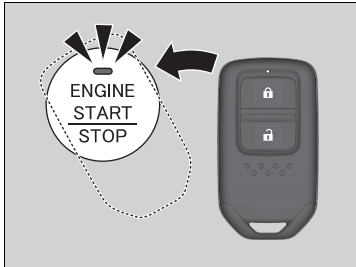

1. Touch the centre of the **ENGINE START/STOP** button with the **H** logo on the keyless remote while the indicator on the **ENGINE START/STOP** button is flashing. The buttons on the keyless remote should be facing you.

▶ The indicator flashes for about 30 seconds.

2. Depress the brake pedal and the clutch pedal (manual transmission) and press the **ENGINE START/STOP** button within 10 seconds after the beeper sounds and the indicator stays on.

▶ If you do not depress the pedal, the mode will change to **ACCESSORY**.

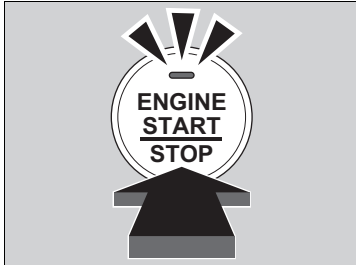

Models with keyless access system

Emergency Engine Stop

The **ENGINE START/STOP** button may be used to stop the engine due to an emergency situation even while driving. If you must stop the engine, do either of the following operations:

- Press and hold the **ENGINE START/STOP** button for about two seconds.
- Firmly press the **ENGINE START/STOP** button twice.

The steering wheel will not lock.

Continuously variable transmission models

The power mode is in ACCESSORY when the engine is stopped.

To change the mode to VEHICLE OFF, move the shift lever to **P** after the vehicle comes to a complete stop. Then press the **ENGINE START/STOP** button twice without depressing the brake pedal.

Manual transmission models

The power mode changes to VEHICLE OFF.

The vehicle comes to a complete stop. After press the **ENGINE START/STOP** button three times without depressing the clutch pedal.

- ▶ The steering wheel will lock.

Emergency Engine Stop

Do not press the button while driving unless it is absolutely necessary for the engine to be switched off.

Jump Starting Procedure

Turn the power to electric devices, such as audio and lights. Turn off the engine, then open the bonnet.

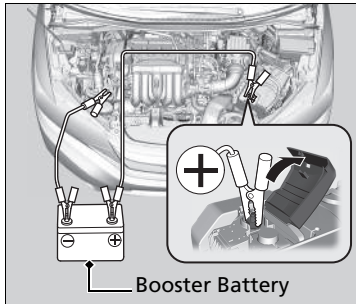

1. Connect the first jumper cable to the position shown in a illustration.
 - ▶ Remove the cover from the under-bonnet fuse box.
 - ▶ **Engine Compartment Fuse Box**
P. 567
2. Connect the other end of the first jumper cable to the booster battery \oplus terminal.
 - ▶ Use a 12-volt booster battery only.
 - ▶ When using the automotive battery charger to boost your 12-volt battery, select a lower charging voltage than 15-volt. Check the charger manual for the proper setting.
3. Connect the second jumper cable to the booster battery \ominus terminal.

Jump Starting

⚠ WARNING

A battery can explode if you do not follow the correct procedure, seriously injuring anyone nearby.

Keep all sparks, open flames, and smoking materials away from the battery.

NOTICE

If a battery sits in extreme cold, the electrolyte inside can freeze. Attempting to jump start with a frozen battery can cause it to rupture.

Securely attach the jumper cables clips so that they do not come off when the engine vibrates. Also be careful not to tangle the jumper cables or allow the cable ends to touch each other while attaching or detaching the jumper cables.

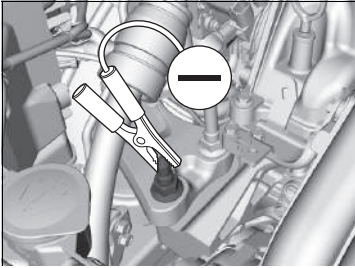

4. Connect the other end of the second jumper cable to the stud bolt as shown. Do not connect this jumper cable to any other part.
5. If your vehicle is connected to another vehicle, start the assisting vehicle's engine and increase its rpm slightly.
6. Attempt to start your vehicle's engine. If it turns over slowly, check that the jumper cables have good metal-to-metal contact.

Jump Starting

Battery performance degrades in cold conditions and may prevent the engine from starting.

Continued

■ What to Do After the Engine Starts

Once your vehicle's engine has started, remove the jumper cables in the following order.

1. Disconnect the jumper cable from your vehicle's stud bolt.
2. Disconnect the other end of the jumper cable from the booster battery ⊖ terminal.
3. Disconnect the jumper cable from your vehicle's battery ⊕ terminal.
4. Disconnect the other end of the jumper cable from the booster battery ⊕ terminal.

Have your vehicle inspected by a nearby service station or a dealer.

Shift Lever Does Not Move

Continuously variable transmission models

Follow the procedure below if you cannot move the shift lever out of the **P** position.

Releasing the Lock

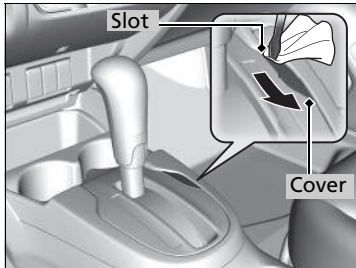

1. Set the parking brake.

Models without keyless access system

2. Remove the key from the ignition switch.

Models with keyless access system

2. Remove the built-in key from the keyless remote.

All models

3. Wrap a cloth around the tip of a small flat-tip screwdriver. Put it into the shift lock release slot as shown in the image, and remove the cover.
4. Insert the key into the shift lock release slot.
5. While pushing the key down, press the shift lever release button and place the shift lever into **N**.
 - ▶ The lock is now released. Have the shift lever checked by a dealer as soon as possible.

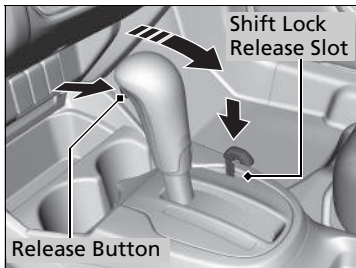

How to Handle Overheating

Overheating symptoms are as follows:

- The high temperature indicator (red) comes on or the engine suddenly loses power.
- Steam or spray comes out of the engine compartment.

■ First thing to do

1. Immediately park the vehicle in a safe place.
2. Turn off all accessories and turn on the hazard warning lights.
 - ▶ **No steam or spray present:** Keep the engine running and open the bonnet.
 - ▶ **Steam or spray is present:** Turn off the engine and wait until it subsides. Then open the bonnet.

☞ How to Handle Overheating

WARNING

Steam and spray from an overheated engine can seriously scald you.

Do not open the bonnet if steam is coming out.

NOTICE

Continuing to drive with the high temperature indicator on may damage the engine.

■ Next thing to do

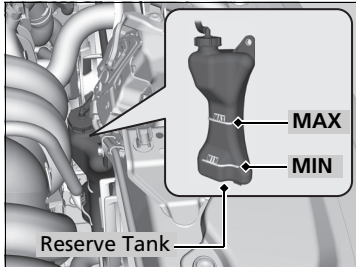

1. Check that the cooling fan is operating and stop the engine once the high temperature indicator goes off.
 - ▶ If the cooling fan is not operating, immediately stop the engine.
2. Once the engine has cooled down, inspect the coolant level and check the cooling system components for leaks.
 - ▶ If the coolant level in the reserve tank is low, add coolant until it reaches the **MAX** mark.
 - ▶ If there is no coolant in the reserve tank, check that the radiator is cool. Cover the radiator cap with a heavy cloth and open the cap. If necessary, add coolant up to the base of the filler neck, and put the cap back on.

■ Last thing to do

Once the engine has cooled sufficiently, restart it and check the high temperature indicator.

If the high temperature indicator is off, resume driving. If it stays on, contact a dealer for repairs.

▶▶ How to Handle Overheating

⚠ WARNING

Removing the radiator cap while the engine is hot can cause the coolant to spray out, seriously scalding you.

Always let the engine and radiator cool down before removing the radiator cap.

If the coolant is leaking, contact a dealer for repairs.

Use water as an emergency/temporary measure only. Have a dealer flush the system with proper antifreeze as soon as possible.

If the Low Oil Pressure Indicator Comes On



■ Reasons for the indicator to come on

Comes on when the engine oil pressure is low.

■ What to do as soon as the indicator comes on

1. Immediately park the vehicle on level ground in a safe place.
2. If necessary, turn the hazard warning lights on.

■ What to do after parking the vehicle

1. Stop the engine and let it sit for about three minutes.
2. Open the bonnet and check the oil level.
 - **Oil Check** P. 486
3. Start the engine and check the low oil pressure indicator.
 - ▶ The indicator goes off: Start driving again.
 - ▶ The indicator does not go off within 10 seconds: Stop the engine and contact a dealer for repairs immediately.

If the Charging System Indicator Comes On



■ Reasons for the indicator to come on

Comes on when the battery is not being charged.

■ What to do when the indicator comes on

Turn off the heating and cooling system*/climate control system*, rear demister, and other electrical systems, and immediately contact a dealer for repairs.

☒ If the Low Oil Pressure Indicator Comes On

NOTICE

Running the engine with low oil pressure can cause serious mechanical damage almost immediately.

☒ If the Charging System Indicator Comes On

If you need to stop temporarily, do not turn off the engine. Restarting the engine may rapidly discharge the battery.

If the Malfunction Indicator Lamp Comes On or Blinks



■ Reasons for the indicator lamp to come on or blink

- Comes on when there is a problem with the engine emissions control system.
- Blinks when engine misfiring is detected.

■ What to do when the indicator lamp comes on

Avoid high speeds and immediately get your vehicle inspected at a dealer.

■ What to do when the indicator lamp blinks

Park the vehicle in a safe place with no flammable items and wait at least ten minutes or more with the engine stopped until it cools.

⌘ If the Malfunction Indicator Lamp Comes On or Blinks

NOTICE

If you drive with the malfunction indicator lamp on, the emissions control system and the engine could be damaged.

If the malfunction indicator lamp blinks again when restarting the engine, drive to the nearest dealer at 50 km/h (30 mph) or less. Have your vehicle inspected.

⌘ If the Brake System Indicator (Red) Comes On

Have your vehicle repaired immediately.

It is dangerous to drive with low brake fluid. If there is no resistance from the brake pedal, stop immediately in a safe place. If necessary, downshift the gears.

If the brake system indicator and **ABS** indicator come on simultaneously, the electronic brake distribution system is not working. This can result in vehicle instability under sudden braking.

Have your vehicle inspected by a dealer immediately.

If the Brake System Indicator (Red) Comes On



■ Reasons for the indicator to come on

- The brake fluid is low.
- There is a malfunction in the brake system.

■ What to do when the indicator comes on while driving

Press the brake pedal lightly to check pedal pressure.

- If normal, check the brake fluid level the next time you stop.
- If abnormal, take immediate action. If necessary, downshift the transmission to slow the vehicle using engine braking.

If the Electric Power Steering (EPS) System Indicator Comes On



■ Reasons for the indicator to come on

- Comes on when there is a problem with EPS system.
- If you depress the accelerator pedal repeatedly to increase the engine speed while the engine is idling, the indicator comes on, and sometimes the steering wheel becomes harder to operate.

■ What to do when the indicator comes on

Stop the vehicle in a safe place and restart the engine.

If the indicator comes on and stays on, immediately have your vehicle inspected by a dealer.

If the Low Tyre Pressure/Deflation Warning System Indicator Comes On or Blinks



■ Reasons for the indicator to come on/blink

A tyre pressure is significantly low, or the deflation warning system has not been calibrated. If there is a problem with the deflation warning system or the compact spare tyre* is installed, the indicator blinks for about one minute, and then stays on.

■ What to do when the indicator comes on

Drive carefully and avoid abrupt cornering and hard braking.

Stop your vehicle in a safe place. Check the tyre pressure and adjust the pressure to the specified level. The specified tyre pressure is on a label on the driver side doorjamb.

- ▶ Calibrate the deflation warning system after the tyre pressure is adjusted.

🔧 **Deflation Warning System Calibration** P. 443

■ What to do when the indicator blinks, then remains on

Have the tyre inspected by a dealer as soon as possible. If the compact spare tyre* causes the indicator to blink, change the tyre to a full-size tyre.

The indicator goes off after driving for a few kilometres (miles).

- ▶ Calibrate the deflation warning system after a full-size tyre is reinstalled.

🔧 **Deflation Warning System Calibration** P. 443

▶▶ If the Low Tyre Pressure/Deflation Warning System Indicator Comes On or Blinks

NOTICE

Driving on an extremely underinflated tyre can cause it to overheat. An overheated tyre can fail. Always inflate your tyres to the prescribed level.

* Not available on all models

If the Low Oil Level Symbol Appears



■ Reasons for the symbol to appear

Appears when the engine oil level is low.

■ What to do as soon as the symbol appears

1. Immediately park the vehicle on level ground in a safe place.
2. If necessary, turn the hazard warning lights on.

■ What to do after parking the vehicle

1. Stop the engine and let it sit for about three minutes.
2. Open the bonnet and check the oil level.

➤ **Oil Check** P. 486

ⓘ If the Low Oil Level Symbol Appears

NOTICE

Running the engine with low oil level can cause serious mechanical damage almost immediately.

This system activates after the engine warms up. If the outside temperature is extremely low, you may have to drive for a long time until the system starts monitoring the engine oil level.

If the symbol appears again, stop the engine and contact a dealer for repairs immediately.

■ Circuit protected and fuse rating

	Circuit Protected	Amps
1	Headlight Low Beam Main	20 A
2	CDC *	(30 A)
3	Hazard	10 A
4	DBW	15 A
5	Wiper	(30 A)
6	Stop	10 A
7	IGP	15 A
8	IG Coil	15 A
9	ECP *	(10 A)
10	INJ	(20 A)
11 *	DC/DC2	30 A
12	Main Fan	30 A
13	Starter SW	(30 A)
14	MG Clutch	7.5 A
15	Battery Sensor *	(7.5 A)
16	–	–
17	DRL	7.5 A
18	Horn	10 A
19	Front Fog Lights *	(15 A)
20	UB ECU	7.5 A

	Circuit Protected	Amps
21	Capacitor *	(15 A)
	DC/DC converter *	(10 A)
22	Interior Light	7.5 A
23	Sub Fan	(30 A)
24 *	DC/DC 1	30 A
25	Starter	(7.5 A)
26	CAM SNSR	(7.5 A)
27	–	–
28	–	–
29	Capacitor *	(10 A)
	DC/DC converter *	(30 A)
30	IGP LAF	(10 A)
31	IGPS	(7.5 A)
32	Right Headlight Low Beam	10 A
33	Left Headlight Low Beam	10 A

*1: Models with the keyless access system have an **ENGINE START/STOP** button instead of an ignition switch.

■ Fuse Box B

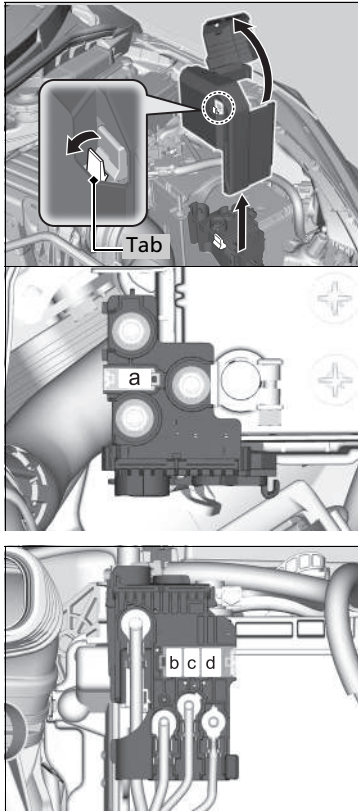

Pull up the cover on the ⊕ terminal, then remove it while pulling out the tab as shown.

Replacement of engine compartment fuses should be done by a dealer.

■ Circuit protected and fuse rating

		Circuit Protected	Amps
a		Battery Main	100 A
b		RB Main 1	70 A
c		RB Main 2	80 A
d		CAP Main	80 A

■ Driver Side Interior Fuse Box

■ Type A

Located behind the instrument panel.

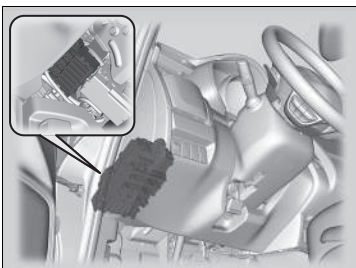

Locate the fuse in question by the following image and table.

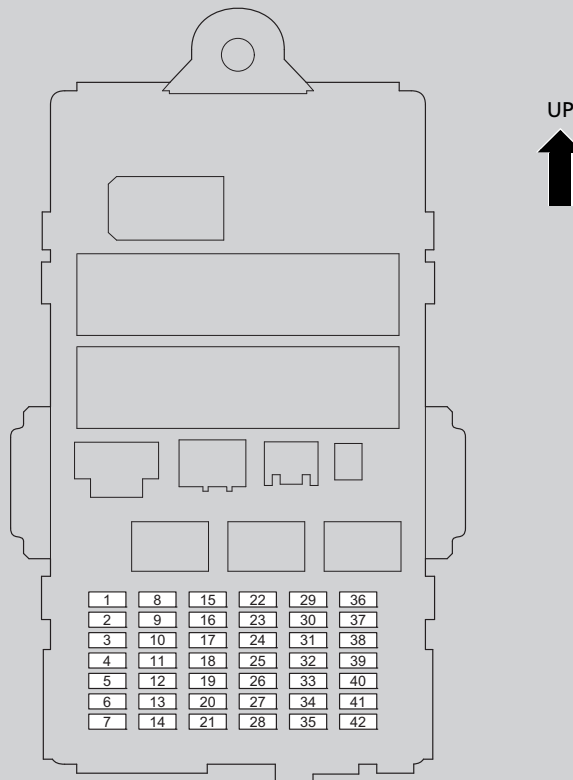

■ **Circuit protected and fuse rating**

	Circuit Protected	Amps
1	Door Lock	20 A
2	–	–
3	Keyless Access System *	(10 A)
4	Left Side Door Unlock	15 A
5	Right Side Door Unlock	15 A
6	–	–
7	–	–
8	Driver's Power Window	20 A
9	Passenger's Power Window	20 A
10	Rear Left Power Window	20 A
11	Rear Right Power Window	20 A
12	Left Side Door Lock	15 A
13	Right Side Door Lock	15 A
14	Rear Fog Light	10 A
15	Right Headlight High Beam	10 A
16	STS*	(7.5 A)
17	–	–
18	–	–
19	Heated Seat *	(20 A)
20	–	–

	Circuit Protected	Amps
21	–	–
22	Washer	15 A
23	Rear Wiper Main *	(10 A)
24	A/C	7.5 A
25	Daytime Running Lights	7.5 A
26	Starter Cut	(7.5 A)
27	ABS/VSA	7.5 A
28	SRS	10 A
29	Left Headlight High Beam	10 A
30	ACG	10 A
31	Power Window	10 A
32	Fuel Pump	15 A
33	SRS	7.5 A
34	Meter	7.5 A
35	Mission SOL	7.5 A
36	Front ACC Socket	20 A
37	ACC	7.5 A
38	ACC Key Lock	(7.5 A)
39	Option	(10 A)
40	Rear Wiper	(10 A)

	Circuit Protected	Amps
41	–	–
42	–	–

* Not available on all models

■ Type B

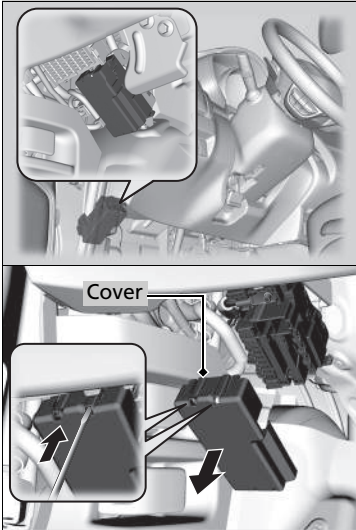

Remove the cover by putting the flat-tip screwdriver into the side slot as shown. Locate the fuse in question by the following image and table.

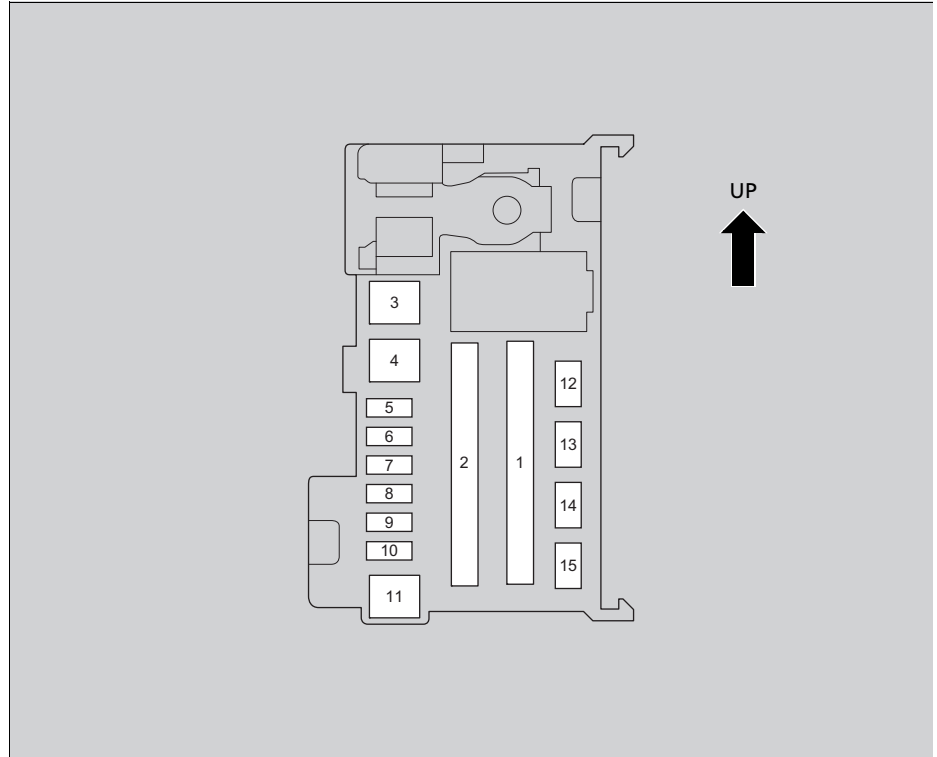

■ Circuit protected and fuse rating

	Circuit Protected	Amps
1	EPS	70 A
	IG Main	50 A* ¹
		30 A* ²
	Fuse Box Main 2	50 A
	ABS/VSA Motor	40 A
	Fuse Box Main 1	30 A
	Fuse Box Main 3	40 A
–	–	
2	–	–
	–	–
	–	–
	–	–
	–	–
	–	–

	Circuit Protected	Amps
3	Heater	30 A
4* ²	IG Main	30 A
5	ABS/VSA FSR	30 A
6	ISA*	(15 A)
7	–	–
8	Super Lock*	20 A
9	Small Light	10 A
10	Centre Accessory Socket*	(20 A)
11	Rear Demister	30 A
12* ¹	Key ACC Lock	(7.5 A)
13	Heated Door Mirror*	(10 A)
14	A/C Blower SW	(7.5 A)
15* ¹	Wiper	30 A

*1: Models without the keyless access system

*2: Models with the keyless access system

* Not available on all models

Left-hand drive type



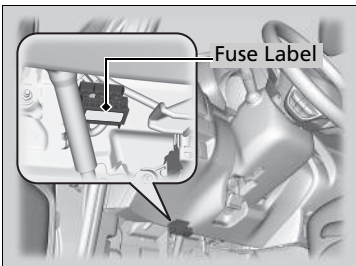

■ **Type C**

Located near the steering column.



Fuse locations are shown on the label.
Locate the fuse in question by the fuse number and label number.

■ **Circuit protected and fuse rating**

		Circuit Protected	Amps
1	—	—	—
2		IG1-2	7.5 A
3		Power Oil Pump	(10 A)
4	—	—	—
5		Accessory	7.5 A
6		IG1-1	7.5 A
7		Back Up	15 A

Right-hand drive type

Passenger Side Interior Fuse Box

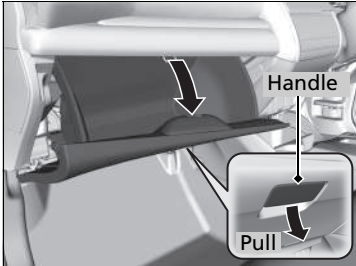

Located behind the glove box.

1. Open the glove box.

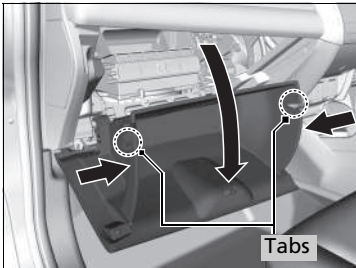



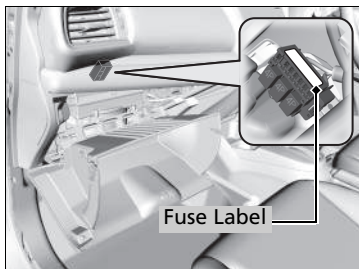

2. Disengage the two tabs by pushing on each side panel.

3. Pivot the glove box out of the way.



Fuse locations are shown on the label.
Locate the fuse in question by the fuse
number and label number.

■ **Circuit protected and fuse rating**

		Circuit Protected	Amps
1	–	–	–
2		IG1-2	7.5 A
3		Power Oil Pump	(10 A)
4	–	–	–
5		Accessory	7.5 A
6		IG1-1	7.5 A
7		Back Up	15 A

Inspecting and Changing Fuses

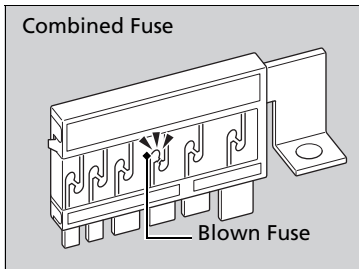
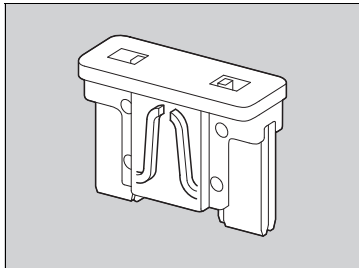
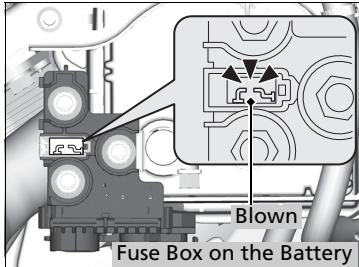

1. Turn the ignition switch to LOCK **0***1. Turn headlights and all accessories off.
2. Check the fuses on the battery in the engine compartment.
 - If the fuse is blown, have it replaced by a dealer.
3. Remove the fuse box cover.
4. Inspect the small fuses in the engine compartment and the vehicle interior.
 - If there is a burned out fuse, remove it with the fuse puller and replace it with a new one.
5. Check the large fuse in the vehicle interior.
 - If the fuse is blown, use a Phillips-head screwdriver to remove the screw and replace it with a new one.

Inspecting and Changing Fuses

NOTICE

Replacing a fuse with one that has a higher rating greatly increases the chances of damaging the electrical system.

Replace fuse with a spare fuse of the same specified amperage.

Confirm the specified amperage using the charts on **Fuse Locations**.

*1: Models with the keyless access system have an **ENGINE START/STOP** button instead of an ignition switch.

Call a professional towing service if you need to tow your vehicle.

■ Flat bed equipment

The operator loads your vehicle on the back of a truck.

This is the best way to transport your vehicle.

■ Wheel lift equipment

The tow truck uses two pivoting arms that go under the front tyres and lift them off the ground. The rear tyres remain on the ground. **This is an acceptable way to tow your vehicle.**

» Emergency Towing

NOTICE

Trying to lift or tow your vehicle by the bumpers will cause serious damage. The bumpers are not designed to support the vehicle's weight.

Never tow your vehicle with just a rope or chain. It is very dangerous since ropes or chains may shift from side to side or break.

■ If your vehicle must be towed with the front wheels on the ground:

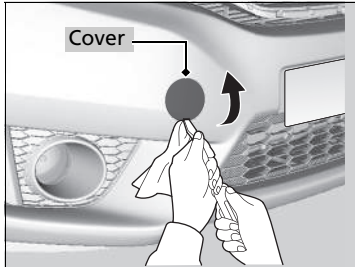

1. Check the ground underneath the vehicle around where the transmission housing is for a fluid leak.
 - ▶ If you find a leak, call a professional towing service and have your vehicle inspected by a dealer.
2. Put cloth on the edge of the cover. Carefully pry with a small flat-tip screwdriver or a metal fingernail file to remove the cover.
 - ▶ The detachable towing hook mounts on the anchor in the front bumper.

☒ If your vehicle must be towed with the front wheels on the ground:

Towing a vehicle is prohibited by law in some countries.

Check and follow the legal requirements of the country in which you are driving before towing your vehicle.

If you cannot follow the exact procedure, do not tow your vehicle with the front wheels on the ground.

If you cannot turn on the engine, you may experience the following while your vehicle is being towed.

- Braking may become difficult since the brake system's power assist is disabled.
- Steering wheel becomes heavy as the power steering system is disabled.

Manual transmission models

- Turning the ignition switch to LOCK [0]*¹ locks the steering wheel.

With the front wheels on the ground, it is best to tow the vehicle no farther than 80 km (50 miles), and keep the speed below 55 km/h (34 mph).

Going down a long slope heats up the brakes. This may prevent the brakes from working properly. If your vehicle needs to be towed on an incline, call a professional towing service.

Make sure to use the properly-designed and attached towing equipment.

*1: Models with the keyless access system have an **ENGINE START/STOP** button instead of an ignition switch.

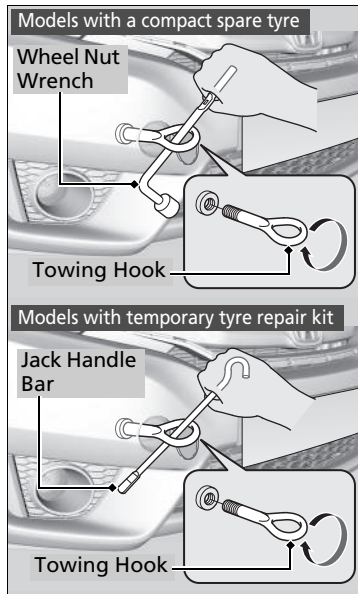

Models with a compact spare tyre

3. Take the towing hook and the wheel nut wrench out of the luggage area.

Models with temporary tyre repair kit

3. Take the towing hook and the jack handle bar out of the luggage area.

All models

4. Screw the towing hook into the hole, and tighten it with the wheel nut wrench securely.
5. Hook the towing device to the towing hook.
6. Start the engine.
 - ▶ If it is difficult to turn on the engine, put the ignition switch in ACCESSORY **I** or ON **II***1.

Manual transmission models

7. Shift to **N**.

Continuously variable transmission models

7. Depress the brake pedal.
8. Shift to **D** and hold for five seconds, then to **N**.

All models

9. Release the parking brake.

ⓘ If your vehicle must be towed with the front wheels on the ground:

NOTICE

Continuously variable transmission models

If you cannot shift the transmission or turn on the engine, will damage the transmission. Your vehicle must be transported with the front wheels off the ground.

*1 : Models with the keyless access system have an **ENGINE START/STOP** button instead of an ignition switch.

When You Cannot Open the Tailgate

What to Do When Unable to Open the Tailgate

If you cannot open the tailgate, use the following procedure.

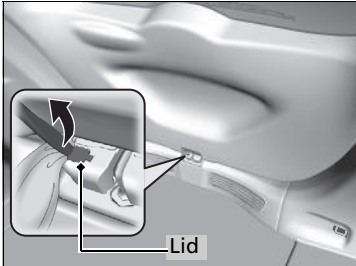

1. Wrap a cloth around the flat-tip screwdriver. Put it into the lid as shown in the image, and open the lid.

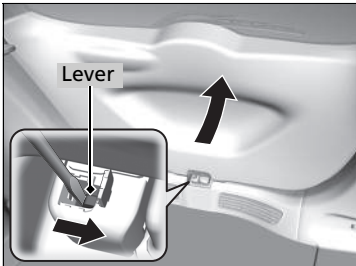

Models with keyless access system

2. To open the tailgate, push the tailgate while sliding the lever to the right.

When You Cannot Open the Tailgate

After taking these steps, contact a dealer to have your vehicle checked.

When you open the tailgate from inside, make sure there is enough space around the tailgate, and it does not hit anyone or any object.

Continued

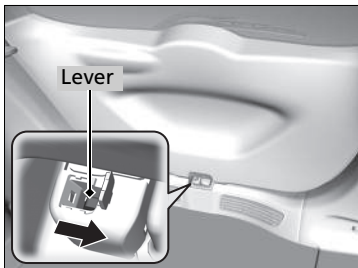

Models without keyless access system

- 2.** Slide the lever to unlock the tailgate.
- 3.** Open the tailgate.

Information

This chapter includes your vehicle's specifications, locations of identification numbers, and other information required by regulation.

Specifications	582
Identification Numbers	
Vehicle Identification Number (VIN), Engine Number and Transmission Number	586
Devices that Emit Radio Waves*	587
EC Declaration of Conformity Content Outline*	588

* Not available on all models

■ Vehicle Specifications

Model	Jazz	
Curb Weight* ¹	1,066 – 1,113 kg (2,350 – 2,454 lbs)	
Curb Weight* ²	1,092 – 1,132 kg (2,407 – 2,496 lbs)	
Maximum permissible weight	1,605 kg (3,538 lbs)	
Maximum permissible axle weight	Front	855 kg (1,885 lbs)
	Rear	835 kg (1,841 lbs)

*1: Manual transmission models

*2: Continuously variable transmission models

■ Engine Specifications

Type	Water cooled 4-stroke SOHC i-VTEC in line, 4-cylinder petrol engine	
Bore x Stroke	73.0 x 78.7 mm (2.87 x 3.10 in)	
Displacement	1,318 cm ³ (80.4 cu-in)	
Compression ratio	13.5 : 1	
Spark Plugs	NGK	DILZKAR7C11S
	DENSO	DXE22HCR11S

■ Fuel

Fuel: Type	Unleaded premium petrol, Research octane number of 95 or higher
Fuel Tank Capacity	40 L (8.8 Imp gal)

■ Battery

Capacity	36AH(5)/45AH(20)* ^{1,2} 36AH(5)/47AH(20)* ²
Type	N-55* ^{1,2}

*1: Manual transmission models

*2: Except for manual transmission models, ask a dealer.

Idle Stop:

The battery installed in this vehicle is specifically designed for a model with Auto Idle Stop. If you need to replace the battery, make sure to select the specified type. Ask a dealer for more details.

■ Washer Fluid

Tank Capacity	2.5 L (2.2 Imp qt)
---------------	--------------------

■ Light Bulbs

Headlights (High/Low Beam)	60/55W (H4, H4/HB2)*
Position Lights	5W
Front Turn Signal Lights	21W (Amber)
Front Fog Lights*	35W (H8LL)
Side Turn Signal Lights (on Door Mirrors)	LED
Brake/Tailights	LED
Rear Turn Signal Lights	21W (Amber)
Back-Up Lights	16W
Rear Fog Light	21W
Rear Licence Plate Lights	5W
High-Mount Brake Light	LED
Interior Lights	
Map lights	8W
Ceiling Light	8W
Luggage Area Light	5W

■ Brake Fluid

Specified	Brake Fluid with DOT 3 or DOT 4
-----------	---------------------------------

■ Continuously Variable Transmission Fluid

Specified	Honda HCF-2 Transmission Fluid	
Capacity	Change	3.4 L (3.0 Imp qt)

■ Manual Transmission Fluid

Specified	Honda Manual Transmission Fluid	
Capacity	Change	1.4 L (1.2 Imp qt)

■ Engine Oil

Recommended	Models with service reminder system	
	Honda Genuine Motor Oil ACEA A3/B3, A5/B5 or higher grade 0W-20	
	European models without service reminder system	
	Honda Genuine Motor Oil ACEA A1/B1, A3/B3, A5/B5 or higher grade 0W-20	
Capacity	Except European models without service reminder system	
	Honda Genuine Motor Oil API service SM or higher grade 0W-20, 0W-30, 5W-30, 10W-30	
	Change	3.4 L (3.0 Imp qt)
	Change including filter	3.6 L (3.2 Imp qt)

■ Engine Coolant

Specified	Honda All Season Antifreeze/Coolant Type2	
Ratio	50/50 with distilled water	
Capacity ³	3.48 L (0.766 Imp gal) *1	
	3.35 L (0.737 Imp gal) *2 (change including the remaining 0.4 L (0.09 Imp gal) in the reserve tank)	
	3.78 L (0.832 Imp gal) (change including the remaining 0.42 L (0.092 Imp gal) in the reserve tank)	

*1: Continuously variable transmission models

*2: Manual transmission models

*3: With single fan

*4: With twin fans

■ Tyre

Regular	Size	185/60R15 84H 185/55R16 83H
	Pressure	See the label on driver's doorjamb.
Compact Spare*	Size	T135/80D15 99M T135/80D15 100M
	Pressure kPa (kgf/cm ² [psi])	420 (4.2 [60])
Wheel Size	Regular	15 x 6J ¹
		16 x 6J ²
	Compact Spare*	15 x 4T

For the tyre size and pressure information, see the label on driver's doorjamb.

*1: Modes with 185/60 R15 tyres

*2: Modes with 185/55 R16 tyres

■ Honda TRK Air Compressor

A weighted emission sound pressure level	81 dB (A)
A weighted sound power level	89 dB (A)

■ Brake

Type	Power assisted
Front	Ventilated disc
Rear	Disc
Parking	Hand brake

* Not available on all models

■ Dimensions

Length	3,995 mm (157.3 in)
Width	1,694 mm (66.7 in)
Height	1,541 mm (60.7 in)
Wheelbase	2,530 mm (99.6 in)
Track	Front 1,483 mm (58.4 in) * ¹
	1,477 mm (58.1 in) * ²
Track	Rear 1,472 mm (58.0 in) * ¹
	1,466 mm (57.7 in) * ²

*1: Modes with 185/60 R15 tyres

*2: Modes with 185/55 R16 tyres

■ The mounting point/rear over hang of coupling device

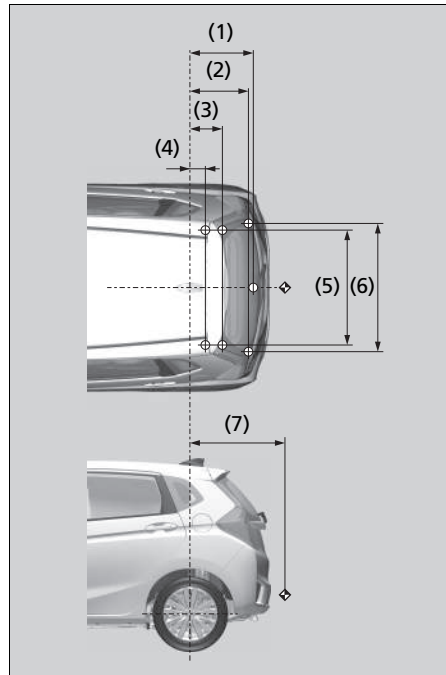

No.	Dimensions
(1)	525 mm (20.8 in)
(2)	485 mm (19.0 in)
(3)	269 mm (10.5 in)
(4)	128 mm (5.0 in)
(5)	950 mm (37.4 in)
(6)	1,061 mm (41.7 in)
(7)	786 mm (30.9 in)

NOTE:

- ○ marks show towbar fixing points.
- ◈ mark shows towbar coupling point.

■ Max. Towing Weight

Trailer with brakes	1,000 kg (2,205 lbs)
Trailer without brakes	450 kg (992 lbs)
The maximum permissible vertical load on the coupling device	95 kg (209 lbs)

Vehicle Identification Number (VIN), Engine Number and Transmission Number

Your vehicle has a 17-digit vehicle identification number (VIN) used to register your vehicle for warranty purposes, and for licensing and insuring your vehicle. See the image below for the locations of your vehicle's VIN, engine number and transmission number.

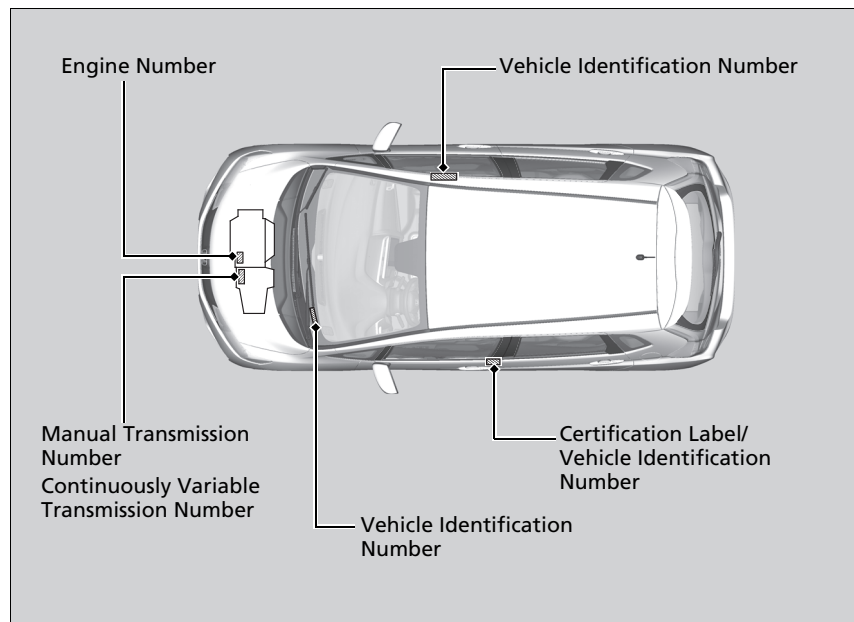



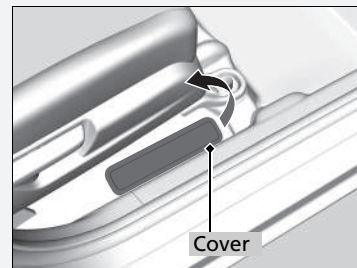

Vehicle Identification Number (VIN), Engine Number and Transmission Number

The interior vehicle identification number (VIN) is located under the cover.



Devices that Emit Radio Waves*

The following products and systems on your vehicle emit radio waves when in operation.

Remote Transmitter*	Immobilizer System
	
Keyless Access System*	Hands-Free Telephone System*
	

* Not available on all models

» Devices that Emit Radio Waves*

European models

Models with remote transmitter

Models with keyless access system

EC Directives

Each of the items in the table complies with the essential requirements and other relevant provisions of R & TTE (Radio equipment and Telecommunications Terminal Equipment and the mutual recognition of their conformity) Directive 1999/5/EC.

See the following URLs for Declaration of conformity:
<http://www.techno.honda-eu.com>

EC Declaration of Conformity



1. The undersigned, Mr. Ryoichi Hiraki, representing the manufacturers, herewith declares that the machinery described below fulfils all the relevant provisions of:

- The EC-directive 2006/42/EC on machinery

2. Description of the machinery

a) Generic denomination: Pantograph jack
b) Function: lifting motor vehicle

c) Model	d) Type
SNB	Honda Type-A
SJD	Honda Type-B
S2A	Honda Type-C
SAH	Honda Type-D
TP6	Honda Type-G
T5A	Honda Type-I
T2V	Honda Type-J

3. Manufacturer (1) : Honda Type-A/B/C/G/I
RIKENKAKI CO., LTD.
5-6-12 Chiyoda Sakado-shi,
Saitama 350-0214
JAPAN

4. Manufacturer (2) : Honda Type-D/J
CHANGZHOU RIKENSEIKO MACHINERY CO., LTD.
No. 1903 Zhongwu Ave. Zhonglou Changzhou,
Jiangsu CHINA

5. Legal person authorised to compile the technical file :
Honda Motor Europe Ltd Belgian Branch
p/a Honda Motor Europe Ltd – Aalst Office
Winggaardveld 1 (Noord V)
B-9300 Aalst (Belgium)

6. References to harmonized standards	7. Other standards or specifications
EN1494:2000+A1:2008	-

8. Done at: Saitama, Japan
9. Date: 1 December, 2009

Ryoichi Hiraki

Ryoichi Hiraki
President of RIKENKAKI CO.,LTD.
President of CHANGZHOU RIKENSEIKO
MACHINERY CO.,LTD.

Note: This declaration becomes invalid, if technical or operational modifications are introduced without the manufacturers consent.

Numbers

7-Speed Manual Shift Mode 398

A

About Open Source Licences 306

ABS (Anti-lock Brake System) 448

Accessories and Modifications 467

Accessory Power Socket 200

Adding

Coolant 488

Engine Oil 487

Washer 492

Additives, Engine Oil 484

Adjustable Speed Limiter 417

Adjusting

Clock 138

Front Seats 183

Head Restraints 185

Headlight Distribution 445

Headlights 171

Mirrors 181

Rear Seats 190

Steering Wheel 180

Temperature 125

Adjusting Headlight Distribution 445

Agile Handling Assist System 442

Air Conditioning System

(Climate Control System) 208

Changing the Mode 208, 209

Defrosting the Windscreen and

Windows 210

Dust and Pollen Filter 523

Maintenance 522

Recirculation/Fresh Air Mode 208, 209

Sensors 212

Using Automatic Climate Control 208

Air Conditioning System

(Heating and Cooling System) 204

Cooling 206

Defrosting the Windscreen and

Windows 207

Heating 205

Maintenance 522

Recirculation/Fresh Air Mode 204

Air Pressure 508, 583

Airbags 49

After a Collision 51

Airbag Care 61

Event Data Recorder 29

Front Airbags (SRS) 51

Indicator 59, 89

Sensors 49

Side Airbags 56

Side Curtain Airbags 58

AM/FM Radio 228, 271

Ambient Meter 121

Anti-lock Brake System (ABS) 448

Indicator 89

Armrest 193

Audio Antenna 217

Audio Remote Controls 219

Audio System 214

Adjusting the Sound 226, 268

Auxiliary Input Jack 216

Error Messages 299

General Information 302

HDMI™ Port 216

iPod 242, 282

MP3/WMA/AAC 245, 279, 285

Recommended CDs 302

Recommended Devices 304

Remote Controls 219

USB Flash Drives 305

USB Port 215

Audio System Theft Protection 218

Auto Idle Stop 404, 409

Auto Idle Stop Function 9

Auxiliary Input Jack 216

Average Fuel Economy 124

Average Speed 125

B

Battery 515

Charging System Indicator 87, 560

Jump Starting 554

Maintenance (Checking the Battery) 515

Maintenance (Replacing) 517

Belts (Seat) 36

Beverage Holders 198

Bluetooth® Audio 248, 288

- Booster Seats (For Children)**..... 79
- Brake System**..... 446
- Anti-lock Brake System (ABS)..... 448
 - Brake Assist System 449
 - Fluid 491
 - Foot Brake..... 447
 - Indicator..... 84, 85, 561
 - Parking Brake 446
- Brake System Indicator (Amber)**..... 85
- Brake System Indicator (Red)**..... 84
- Brightness Control (Instrument Panel)**... 178
- Bulb Replacement**..... 493
- Back-Up Light..... 499
 - Brake/Taillight..... 500
 - Daytime Running Lights..... 498
 - Fog Lights..... 495
 - Front Turn Signal Lights 496
 - Headlights..... 493
 - High-Mount Brake Light 501
 - Interior Lights 502
 - Luggage Area Light 503
 - Position Light Bulbs..... 497
 - Rear Fog Light 499
 - Rear Licence Plate Light 501
 - Rear Turn Signal Light..... 499
 - Side Turn Signal Lights..... 498
- Bulb Specifications**..... 583
- C**
- Carbon Monoxide Gas**..... 81
- Carrying Luggage**..... 377, 379
- CD Player**..... 239, 279
- Changing Bulbs** 493
- Charging System Indicator**..... 87, 560
- Child Restraint System** 62
- Booster Seats 79
 - Child Restraint System for Infants..... 66
 - Child Restraint System for Small Children 68
 - Installing a Child Restraint System with a Lap/Shoulder Seat Belt 74
 - Larger Children 78
 - Rearward Facing Child Restraint System 66
 - Selecting a Child Restraint System 69
 - Using a Tether..... 77
- Child Safety**..... 62
- Childproof Door Locks..... 152
- Childproof Door Locks** 152
- City-Brake Active system**..... 450
- Cleaning the Exterior**..... 527
- Cleaning the Interior**..... 525
- Climate Control System**..... 208
- Changing the Mode..... 208
 - Defrosting the Windscreen and Windows..... 210
 - Dust and Pollen Filter..... 523
 - Recirculation and Fresh Air Mode 209
 - Sensors 212
 - Using Automatic Climate Control 208
- Clock**..... 138
- Coat Hook**..... 201
- Compact Spare Tyre**..... 533, 583
- Console Compartment**..... 197
- Continuously Variable Transmission** 395
- 7-Speed Manual Shift Mode 398
 - Creeping..... 395
 - Fluid 490
 - Kickdown 395
 - Operating the Shift Lever 397
 - Shift Lever Does Not Move..... 557
 - Shifting..... 396
- Controls** 137
- Coolant (Engine)**..... 488
- Adding to the Radiator 489
 - Adding to the Reserve Tank 488
 - Overheating..... 558
- Creeping**
- (Continuously Variable Transmission).... 395
- Cruise Control** 414
- Cup Holders**..... 198
- Customized Features** 129, 307
- D**
- DAB**
- (Digital Audio Broadcasting)..... 235, 276
- Daytime Running Lights** 174
- Dead Battery** 554
- Deflation Warning System** 443
- Indicator 94, 563
- Defrosting the Windscreen and Windows**..... 207, 210

Devices that Emit Radio Waves.....	587
Digital Audio Broadcasting (DAB).....	235, 276
Dimming Headlights	167
Dipstick (Engine Oil)	486
Directional Signals (Turn Signals)	166
Display Button.....	252
Door Mirrors.....	182
Doors	140
Door and Tailgate Open Indicator	35, 93
Keys.....	140
Locking/Unlocking the Doors from the Inside	150
Locking/Unlocking the Doors from the Outside	144
Lockout Prevention System	149
Driving	375
Braking	446
Continuously Variable Transmission	395
Cruise Control	414
Shifting Gear	396, 401
Starting the Engine	386, 389
Dust and Pollen Filter	523

E

EC Declaration of Conformity Content Outline.....	588
Elapsed Time	124

Electric Power Steering (EPS) System Indicator	95, 562
Emergency Stop Signal.....	455
Emergency Towing.....	576
Engine	
Coolant	488
Jump Starting	554
Oil	484
Starting	386, 389
Switch Buzzer.....	161
Engine Coolant	488
Adding to the Radiator	489
Adding to the Reserve Tank.....	488
Overheating	558
Engine Oil	484
Adding	487
Checking.....	486
Low Oil Pressure Indicator.....	86, 560
Recommended Engine Oil.....	484
Engine Start/Stop Button	162
EPS (Electric Power Steering) System	95, 562
Exhaust Gas Hazard (Carbon Monoxide)	81
Exterior Care (Cleaning).....	527
Exterior Mirrors	182

F

Features.....	213
---------------	-----

Filter Dust and Pollen.....	523
Flat Tyre	533
Floor Mats.....	526
Fluids	
Brake	491
Continuously Variable Transmission (CVT).....	490
Engine Coolant	488
Manual Transmission.....	490
Windscreen Washer	492
Folding Down the Rear Seats	191
Foot Brake	447
Forward Collision Warning.....	428
Front Airbags (SRS).....	51
Front Fog Light Indicator	96
Front Seats	183
Adjusting	183
Fuel.....	464
Economy.....	466
Gauge.....	126
Instant Fuel Economy	125
Low Fuel Indicator.....	89
Range	124
Recommendation	464
Refueling.....	464
Fuel Economy	466
Fuel Fill Cap	23, 465
Fuel Fill Door	23, 465
Fuses.....	565
Inspecting and Changing.....	575

Locations..... 565, 567, 568, 570

G

Gasoline (Fuel)

Instant Fuel Economy..... 125

Low Fuel Indicator 89

Gauges..... 121

Gear Shift Lever Positions

Continuously Variable

Transmission 396

Manual Transmission 401

Glass (care) 525, 528

Glove Box 197

H

Halogen Bulbs..... 493

Hands-Free Telephone (HFT)

System..... 333, 356

Automatic Import of Cellular Phonebook and
Call History 367

Automatic Import of Mobile Phonebook and
Call History 348

Caller's ID Information 346

HFT Buttons..... 333, 356

HFT Menus 336, 359

HFT Status Display 335, 357

Limitations for Manual Operation 335, 358

Making a Call 351, 370

Options During a Call 355, 373

Phone Setup..... 340, 362

Receiving a Call..... 354, 373

Ring Tone..... 346, 366

Speed Dial..... 349, 368

To Clear the System 347

Hazard Warning Button 2, 3

HDMI™ Port..... 216

Head Restraints 185

Headlights..... 167

Adjuster 171

Aiming 493

Dimming 167

Operating..... 167

Heaters (Seat) 203

Heating and Cooling System 204

HFT (Hands-Free Telephone) 333, 356

High Beam Indicator 96

High Beam Support System 172

Indicator..... 100

Hill Start Assist System 388, 392

I

Identification Numbers 586

Vehicle Identification 586

Ignition Switch 161

Illumination Control..... 178

Knob..... 178

Immobilizer System 156

Indicator..... 97

Indicators 84

Adjustable Speed Limiter..... 99

Anti-lock Brake System (ABS) 89

Auto Idle Stop..... 100

Auto Idle Stop System..... 101

Brake System (Amber)..... 85

Brake System (Red) 84

Charging System..... 87

City-Brake Active System (CTBA) 104

Cruise Control and Adjustable Speed Limiter

Set Speed..... 99

Cruise Main 99

Door and Tailgate Open 35, 93

Electric Power Steering (EPS) System 95

Forward Collision Warning..... 102

Front Fog Light 96

High Beam 96

High Beam Support System..... 100

High Temperature..... 92

Immobilizer System 97

Keyless Access System..... 98

Lane Departure Warning..... 103

Lights On 96

Low Fuel 89

Low Oil Pressure 86

Low Temperature..... 92

Low Tyre Pressure/Deflation Warning

System 94

M (7-speed manual shift mode) /Shift 88

Malfunction Indicator Lamp 86

Parking Brake and Brake System 84

Passenger Front Airbag On/Off..... 90

Rear Fog Light.....	96	Lockout Prevention	149	Low Fuel Indicator.....	89
Seat Belt Reminder.....	88	Master Keys.....	140	Low Keyless Remote Signal Strength.....	143
Security System Alarm.....	98	Number Tag	142	Low Oil Level Symbol	564
Shift Down	99	Rear Door Won't Open	152	Low Oil Pressure Indicator	86, 560
Shift Lever Position.....	87	Remote Transmitter	146	Low Tyre Pressure/Deflation Warning	
Shift Up	99	Types and Functions	140	System Indicator	94, 563
Supplemental Restraint System	89	Won't Turn.....	26	Lower Anchorages	72
System Message	95	Kickdown		Lubricant Specifications Chart.....	583
Transmission	87	(Continuously Variable Transmission) ...	395	Luggage (Load Limit).....	379
Turn Signal	96			Luggage Area Cover	202
Vehicle Stability Assist (VSA) System.....	91				
VSA OFF	91	L			
Instant Fuel Economy	125	Lane Departure Warning	432	M	
Instrument Panel.....	83	Language (HFT)	314, 324	Maintenance.....	469
Brightness Control	178	Light Switches.....	167	Air Conditioning.....	522
Intelligent Speed Limiter	421	Lights.....	167, 493	Battery	515
Interior Lights.....	194	Bulb Replacement.....	493	Brake Fluid	491
Interior Rearview Mirror	181	Fog Lights.....	169	Cleaning	525
iPod.....	242, 282	High Beam Indicator	96	Climate Control.....	522
		Interior	194	Coolant.....	488
		Lights On Indicator	96	Oil.....	486
		Turn Signals.....	166	Precautions	470
J		Load Limit	379	Radiator	489
Jack (Wheel Nut Wrench).....	536	Locking/Unlocking	140	Remote Transmitter.....	520
Jump Starting.....	554	Childproof Door Locks.....	152	Replacing Light Bulbs	493
		From Inside.....	150	Safety.....	471
		From Outside.....	144	Transmission Fluid	490
K		Keys	140	Tyres	508
Key Number Tag	142	Using a Key	148	Under the Bonnet.....	482
Keyless Access System	144	Lockout Prevention System.....	149	Malfunction Indicator Lamp.....	86, 561
Keyless Lockout Prevention.....	149	Low Battery Charge.....	560	Manual Transmission	401
Keys.....	140				

Map Lights	195
Maximum Loaded Vehicle Weight	379
Maximum Permissible Weight	379
Meters, Gauges	121
Mirrors	181
Adjusting	181
Door	182
Exterior	182
Interior Rearview	181
Modifications (and Accessories)	467
MP3	239, 245, 279, 285
Multi-Information Display	122
Multi-View Rear Camera	462

N

Numbers (Identification)	586
--------------------------------	-----

O

Odometer	124
Oil (Engine)	484
Adding	487
Checking	486
Low Oil Pressure Indicator	86, 560
Recommended Engine Oil	484
Viscosity	484
On Board Apps	292
Opening/Closing	
Bonnet	483
Power Windows	159

Tailgate	153
Outside Temperature Display	125
Overheating	558

P

Paddle Shifters	
(7-Speed Manual Shift Mode)	398
Parking Brake	446
Parking Brake and Brake System	
Indicator	84, 561
Parking Sensor System	457
Passenger Front Airbag Off System	54
Passing Indicators	167
Petrol	23, 464
Economy	466
Gauge	126
Information	464
Refueling	464
Power Windows	159
Precautions While Driving	393
Rain	393
Pregnant Women	46
Preset Memory	228, 235
Puncture (Tyre)	533

R

Radiator	489
Radio (AM/FM)	228, 271
Radio Data System (RDS)	229, 274

Range	124
RDS (Radio Data System)	229, 274
Rear Demister Button	179
Rear Fog Light Indicator	96
Rear Seats (Folding Down)	191
Rear Wiper	177
Rearview Mirror	181
Refueling	464
Fuel Gauge	126
Low Fuel Indicator	89
Petrol	464, 582
Regulations	587, 588
Remote Transmitter	146
Replacement	
Battery	517, 520
Bulbs	493
Fuses	565, 568
Tyres	511
Wiper Blade Rubber	504
Resetting a Trip Meter	124

S

Safe Driving	31
Safety Check	35
Safety Labels	82
Safety Message	30
Seat Belts	36
Adjusting the Shoulder Anchor	44
Automatic Seat Belt Tensioners	41
Checking	47

Fastening	42	Side Airbags	56	Time (Setting)	138
Installing a Child Restraint System		Side Curtain Airbags	58	Tools	532
with a Lap/Shoulder Seat Belt	74	Spare Tyre	533, 583	Towing a Trailer	380
Pregnant Women	46	Spark Plugs	582	Equipment and Accessories	382
Reminder	39	Specifications	582	Load Limits	380
Warning Indicator	39, 88	Specified Fuel	464, 582	Towing Your Vehicle	
Seat Heaters	203	Speed Alarm Setting	127	Emergency	576
Seats	183	Speedometer	121	Traffic Sign Recognition System	436
Adjusting	183	SRS Airbags (Airbags)	51	Transmission	396, 401
Front Seats	183	Start/Stop Button	162	7-Speed Manual Shift Mode	398
Rear Seats	190	Starting the Engine	386, 389	Continuously Variable	396
Seat Heaters	203	Does Not Start	551	Fluid	490
Security System	156	Engine Switch Buzzer	161	Manual	401
Immobilizer System Indicator	97	Jump Starting	554	Shift Lever Position Indicator	87, 397
Security System Alarm Indicator	98	Steering Wheel	180	Trip Meter	124
SEL/RESET Button	123	Adjusting	180	Troubleshooting	531
Select Lever	21, 396, 401	Stopping	456	Blown Fuse	565, 568
Selecting a Child Restraint System	69	Supplemental Restraint System (SRS)	51	Brake Pedal Vibrates	26
Selector Knob (Audio)	221	Switches		Buzzer Sounds When Opening Door	27
Setting the Clock	138	(Around the Steering Wheel)	2, 4, 161	Emergency Towing	576
Shift Down Indicator	99, 402	System Message Indicator	95	Engine Won't Start	551
Shift Lever	21, 396, 401	T		Noise When Braking	28
Operation	21, 397, 401	Tachometer	121	Overheating	558
Releasing	557	Tailgate	153	Puncture/Flat Tyre	533
Won't Move	557	Temperature		Rear Door Won't Open	27
Shift Lever Position Indicator	87, 397	Outside Temperature Display	125	Shift Lever Won't Move	557
Shift Up Indicator	99, 400, 402	Temperature Sensor	125, 212	Warning Indicators	84
Shifting		Temporarily Repairing a Flat Tyre	541	Turn Signals	166
Continuously Variable Transmission	396	Tie-down Anchors	201	Indicators (Instrument Panel)	96
Manual Transmission	401			Tyres	508
Shoulder Anchor	44			Air Pressure	508, 583

Checking and Maintaining.....	508
Inspection.....	508
Puncture (Flat Tyre).....	533
Rotation.....	512
Spare Tyre.....	533, 583
Tyre Chains.....	513
Wear Indicators.....	510
Winter.....	513

U

Unlocking the Doors.....	144
Unlocking the Front Doors from the Inside.....	150
USB Flash Drives.....	305
USB Port.....	215
Using the Keyless Access System.....	144

V

Vanity Mirrors.....	7
Vehicle Identification Numbers.....	586
Vehicle Stability Assist (VSA).....	440
Off Button.....	441
Off Indicator.....	91
System Indicator.....	91
Ventilation.....	204, 208, 209
Viscosity (Oil).....	484, 583
VSA (Vehicle Stability Assist).....	440

W

Warning and Information	
Messages.....	106
Warning Indicator On/Blinking.....	560
Warning Labels.....	82
Watts.....	583
Wear Indicators (Tyre).....	510
Wheel Nut Wrench (Jack Handle).....	537
When You Cannot Open the Tailgate.....	579
Wi-Fi Connection.....	296
Window Washers.....	175
Adding/Refilling Fluid.....	492
Switch.....	175
Windows (Opening and Closing).....	159
Windscreen.....	175
Cleaning.....	525, 528
Defrosting/Defogging.....	207, 210
Washer Fluid.....	492
Wiper Blades.....	504
Wipers and Washers.....	175
Winter Tyres.....	513
Tyre Chains.....	513
Wipers and Washers.....	175
Checking and Replacing Wiper Blades.....	504
WMA.....	239, 245, 279, 285
Worn Tyres.....	508